



# DEVELOPMENT PERMIT APPLICATION

**NOTE: Development Permit Application forms must accompany all other Community Development Department land use applications. This form and all documents associated with it are public record once submitted.**

<b>PROPERTY LOCATION</b>		
Physical Address <b>Eaglecrest Ski Area, 3000 Fish Creek Road, Juneau, Alaska</b>		
Legal Description(s) (Subdivision, Survey, Block, Tract, Lot) <b>SECTION 31 T 41 S R 67 E CRM</b>		
Parcel Number(s) <b>3D1021000010</b>		
<input type="checkbox"/> This property is located in the downtown historic district <input type="checkbox"/> This property is located in a mapped hazard area, if so, which _____		
<b>LANDOWNER/ LESSEE</b>		
Property Owner <b>CBJ</b>	Contact Person <b>Dave Scanlan</b>	
Mailing Address <b>155 South Seward Street, Juneau AK 99801</b>	Phone Number(s) <b>907.790.2000</b>	
E-mail Address <b>Dave.Scanlan@eaglecrest.com</b>		
<b>LANDOWNER/ LESSEE CONSENT</b>		
Required for Planning Permits, not needed on Building/ Engineering Permits.		
Consent is required of all landowners/ lessees. If submitted with the application, alternative written approval may be sufficient. Written approval must include the property location, landowner/ lessee's printed name, signature, and the applicant's name.		
I am (we are) the owner(s) or lessee(s) of the property subject to this application and I (we) consent as follows:		
A. This application for a land use or activity review for development on my (our) property is made with my complete understanding and permission.		
B. I (we) grant permission for the City and Borough of Juneau officials/employees to inspect my property as needed for purposes of this application.		
x	<b>Dave Scanlan</b> Landowner/Lessee (Printed Name)	Eaglecrest General Manager Title (e.g.: Landowner, Lessee)
x	<b>Dave Scanlan</b> Landowner/Lessee (Signature)	Digitally signed by Dave Scanlan Date: 2023.06.05 08:36:39 -08'00' 6.5.23 Date
x	_____ Landowner/Lessee (Printed Name)	_____ Title (e.g.: Landowner, Lessee)
x	_____ Landowner/Lessee (Signature)	_____ Date
NOTICE: The City and Borough of Juneau staff may need access to the subject property during regular business hours. We will make every effort to contact you in advance, but may need to access the property in your absence and in accordance with the consent above. Also, members of the Planning Commission may visit the property before a scheduled public hearing date.		
<b>APPLICANT</b> <span style="float: right;">If same as LANDOWNER, write "SAME"</span>		
Applicant (Printed Name) <b>Dave Scanlan</b>	Contact Person	
Mailing Address <b>CBJ, 155 South Seward Street, Juneau Ak 99801</b>	Phone Number(s) <b>907.790.2000</b>	
E-mail Address <b>Dave.Scanlan@eaglecrest.com</b>		
x	<b>Dave Scanlan</b> Applicant's Signature	Digitally signed by Dave Scanlan Date: 2023.06.05 08:38:02 -08'00' 6.5.2023 Date of Application

To be completed by Applicant

-----DEPARTMENT USE ONLY BELOW THIS LINE-----

Intake Initials  
**JLS**

**INCOMPLETE APPLICATIONS WILL NOT BE ACCEPTED**

For assistance filling out this form, contact the Permit Center at 586-0770.

Case Number <b>CSP23-001</b>	Date Received <b>6-6-23</b>
---------------------------------	--------------------------------



# CITY/STATE PROJECT AND LAND ACTION REVIEW APPLICATION

See reverse side for more information regarding the permitting process and the materials required for a complete application.

**NOTE: Must be accompanied by a DEVELOPMENT PERMIT APPLICATION form.**

To be completed by Applicant	<b>PROJECT SUMMARY</b>	
	Construct a gondola and summit house at Eaglecrest ski Area. Work includes construction of associated utilities, access roads and multiuse recreational trails, borrow sites, recreational structures and facilities.	
	<b>TYPE OF PROJECT REVIEW:</b>	<input checked="" type="checkbox"/> City Project Review <span style="margin-left: 200px;"><input checked="" type="checkbox"/> State Project Review</span>
	<b>PROJECT NUMBERS ASSOCIATED WITH PROPOSAL:</b>	
	Is this project associated with any other Land Use Permits?      YES    Case No.: <u>USE23-09</u> NO Capital Improvement Program # (CIP) <u>E28-102</u> Local Improvement District # (LID) _____ State Project # _____	
<b>ESTIMATED PROJECT COST: \$ 10M</b>		
<b>ALL REQUIRED MATERIALS ATTACHED</b>		
<input checked="" type="checkbox"/> Complete application <input checked="" type="checkbox"/> Pre-Application notes (if applicable) <input checked="" type="checkbox"/> Narrative including: Current use of land or building(s) Proposed use of land or building(s) How the proposed project complies with the Comprehensive Plan How the proposed project complies with the Land Use Code (Title 49) <input checked="" type="checkbox"/> Site Plan (details on page 2)		

**NOTE: This application is required even if the proposed project is associated with other Land Use permits.**

-----DEPARTMENT USE ONLY BELOW THIS LINE-----

CITY/STATE PROJECT FEES	Fees	Check No.	Receipt	Date
Application Fees (≥\$2.5M)	\$ <u>1,600</u>			
Pub. No. Sign Fee	\$ <u>50.00</u>			
Pub. No. Sign Deposit	\$ <u>100.00</u>			
<b>TOTAL FEES</b>	\$ <u>1,750.00</u>			

This form and all documents associated with it are public record once submitted.

**INCOMPLETE APPLICATIONS WILL NOT BE ACCEPTED**

For assistance filling out this form, contact the Permit Center at 586-0770.

Case Number <u>CSP23-001</u>	Date Received <u>6-7-23</u>
---------------------------------	--------------------------------



# DEVELOPMENT PERMIT APPLICATION

**NOTE: Development Permit Application forms must accompany all other Community Development Department land use applications. This form and all documents associated with it are public record once submitted.**

To be completed by Applicant	<b>PROPERTY LOCATION</b>		
	Physical Address <b>Eaglecrest Ski Area, 3000 Fish Creek Road, Juneau, Alaska</b>		
	Legal Description(s) (Subdivision, Survey, Block, Tract, Lot) <b>SECTION 31 T 41 S R 67 E CRM</b>		
	Parcel Number(s) <b>3D1021000010</b>		
	<input type="checkbox"/> This property is located in the downtown historic district <input type="checkbox"/> This property is located in a mapped hazard area, if so, which _____		
	<b>LANDOWNER/ LESSEE</b>		
	Property Owner <b>CBJ</b>	Contact Person <b>Dave Scanlan</b>	
	Mailing Address <b>155 South Seward Street, Juneau AK 99801</b>	Phone Number(s) <b>907.790.2000</b>	
	E-mail Address <b>Dave.Scanlan@eaglecrest.com</b>		
	<b>LANDOWNER/ LESSEE CONSENT</b>		
Required for Planning Permits, not needed on Building/ Engineering Permits.			
Consent is required of all landowners/ lessees. If submitted with the application, alternative written approval may be sufficient. Written approval must include the property location, landowner/ lessee's printed name, signature, and the applicant's name.			
I am (we are) the owner(s) or lessee(s) of the property subject to this application and I (we) consent as follows:			
A. This application for a land use or activity review for development on my (our) property is made with my complete understanding and permission.			
B. I (we) grant permission for the City and Borough of Juneau officials/employees to inspect my property as needed for purposes of this application.			
<b>Dave Scanlan</b> <span style="float: right;">Eaglecrest General Manager</span> _____ Landowner/Lessee (Printed Name) <span style="float: right;">Title (e.g.: Landowner, Lessee)</span>			
X <b>Dave Scanlan</b> <span style="float: right;">Digitally signed by Dave Scanlan</span> _____ Landowner/Lessee (Signature) <span style="float: right;">Date: 2023.06.05 08:36:39 -08'00'</span> <span style="float: right;"><b>6.5.23</b></span> <span style="float: right;">Date</span>			
_____ Landowner/Lessee (Printed Name) <span style="float: right;">Title (e.g.: Landowner, Lessee)</span>			
X _____ Landowner/Lessee (Signature) <span style="float: right;">Date</span>			
NOTICE: The City and Borough of Juneau staff may need access to the subject property during regular business hours. We will make every effort to contact you in advance, but may need to access the property in your absence and in accordance with the consent above. Also, members of the Planning Commission may visit the property before a scheduled public hearing date.			
<b>APPLICANT</b> <span style="float: right;">If same as LANDOWNER, write "SAME"</span>			
Applicant (Printed Name) <b>Dave Scanlan</b>	Contact Person		
Mailing Address <b>CBJ, 155 South Seward Street, Juneau Ak 99801</b>	Phone Number(s) <b>907.790.2000</b>		
E-mail Address <b>Dave.Scanlan@eaglecrest.com</b>			
X <b>Dave Scanlan</b> <span style="float: right;">Digitally signed by Dave Scanlan</span> _____ Applicant's Signature <span style="float: right;">Date: 2023.06.05 08:38:02 -08'00'</span> <span style="float: right;"><b>6.5.2023</b></span> <span style="float: right;">Date of Application</span>			

-----DEPARTMENT USE ONLY BELOW THIS LINE-----

Intake Initials

**JLS**

**INCOMPLETE APPLICATIONS WILL NOT BE ACCEPTED**

For assistance filling out this form, contact the Permit Center at 586-0770.

Case Number

**USE 23-009**

Date Received

**6-6-23**



# ALLOWABLE/CONDITIONAL USE PERMIT APPLICATION

See reverse side for more information regarding the permitting process and the materials required for a complete application.

**NOTE: Must be accompanied by a DEVELOPMENT PERMIT APPLICATION form.**

To be completed by Applicant

**PROJECT SUMMARY**

Construct a gondola and summit house at Eaglecrest ski Area. Work includes construction of associated utilities, access roads and multiuse recreational trails, borrow sites, recreational structures and facilities.

**TYPE OF ALLOWABLE OR CONDITIONAL USE PERMIT REQUESTED**

Accessory Apartment – Accessory Apartment Application (AAP)

Use Listed in 49.25.300 – Table of Permissible Uses (USE)

Table of Permissible Uses Category: 21.100 Lodge or Resort / 6.270 Ariel Conveyance

**IS THIS A MODIFICATION or EXTENSION OF AN EXISTING APPROVAL?**

YES – Case # \_\_\_\_\_

NO

**UTILITIES PROPOSED**

**WATER:** Public On Site

**SEWER:** Public On Site

**SITE AND BUILDING SPECIFICS**

Total Area of Lot 13,777 acres \_\_\_\_\_ square feet Total Area of Existing Structure(s) see attached square feet

Total Area of Proposed Structure(s) see attached square feet

**EXTERNAL LIGHTING**

Existing to remain	No	Yes – Provide fixture information, cutoff sheets, and location of lighting fixtures
Proposed	No	Yes – Provide fixture information, cutoff sheets, and location of lighting fixtures

**ALL REQUIRED DOCUMENTS ATTACHED**

*If this is a modification or extension include:*

**Narrative including:**

- Current use of land or building(s)
- Description of project, project site, circulation, traffic etc.
- Proposed use of land or building(s)
- How the proposed use complies with the Comprehensive Plan

- Notice of Decision and case number
- Justification for the modification or extension
- Application submitted at least 30 days before expiration date

**Plans including:**

- Site plan
- Floor plan(s)
- Elevation view of existing and proposed buildings
- Proposed vegetative cover
- Existing and proposed parking areas and proposed traffic circulation
- Existing physical features of the site (e.g.: drainage, habitat, and hazard areas)

-----DEPARTMENT USE ONLY BELOW THIS LINE-----

ALLOWABLE/CONDITIONAL USE FEES				
	Fees	Check No.	Receipt	Date
Application Fees	\$ <u>500.00</u>			
Admin. of Guarantee	\$ <u>—</u>			
Adjustment	\$ <u>—</u>			
Pub. Not. Sign Fee	\$ <u>50.00</u>			
Pub. Not. Sign Deposit	\$ <u>100.00</u>			
<b>Total Fee</b>	<b>\$ <u>650.00</u></b>			

This form and all documents associated with it are public record once submitted.

**INCOMPLETE APPLICATIONS WILL NOT BE ACCEPTED**

For assistance filling out this form, contact the Permit Center at 586-0770.

Case Number	Date Received
<u>USE23-009</u>	<u>6-7-23</u>

# Eaglecrest Gondola and Summit House Project Narrative

## **Introduction:**

Eaglecrest Ski Area is located in the middle of Douglas Island at the end of Fish Creek road. Eaglecrest Ski Area has a long history of serving the winter recreation needs of the community since the opening in 1977. Current visitation during the winter season ranges from 30,000 to 60,000 annual visits over the course of a typical 94-day winter operating season. This translates to 320 to 640 average daily visitors. Current peak visitation during the winter season will reach 1500 visitors in a single day. Parking capacity is designed to hold 700 vehicles in addition to our bus drop off zone.

Eaglecrest has two primary day use lodges – Porcupine and Fish Creek – which house administrative offices, equipment rental shop, equipment repair shop, retail shop, restrooms, and general seating areas. The ski area has a potable water treatment system authorized under Public Water System ID# AK2110643. The wastewater needs are accommodated by an in-ground septic system. The water and wastewater systems have a design capacity for 1500 daily visitors.

The ski area and its existing infrastructure currently sits virtually idle for 7 months out of the year. The proposed Gondola and Summit House project is intended to change this by enabling Eaglecrest to cater to summer visitors as well as winter snow sports enthusiasts. The target summer visitation once the operation has matured is to serve a total of 80,000 to 100,000 total visitors over a 140-day summer operating season. This translates to 571 to 714 average daily visitors, which is consistent with our current average winter usage. It is anticipated that 95% of the proposed summer visitors will arrive at Eaglecrest on tour buses from the cruise boat docks. This translates to between 13 and 16 round trip bus trips per day between Eaglecrest and downtown Juneau.

All the Eaglecrest core infrastructure – parking, transportation, water, and wastewater – is designed to handle far greater daily capacities than the visitation numbers expected as a result of the proposed Gondola summer adventure experiences.

## **History of Planning and Summer Operations**

Overtime, the ski area has made various efforts to expand into summer operations, most famously in the mid-1980s with the installation of fiberglass bubbles on the Ptarmigan chair combined with a ridgetop hiking trail network. Eaglecrest began working with summer concessionaires again in 2006 with the construction of their Zipline Canopy Tour. During the summer season of 2023 Eaglecrest will be working with four different summer tour operators providing a wide array of outdoor experiences.

During the Eaglecrest Board 2008 Strategic Planning Process, the Board developed the following Mission and Vision Statements

**Mission:** Eaglecrest Ski Area is a community-owned winter recreation area and a year-round destination for outdoor recreation and education, providing a wide range of affordable non-motorized winter and summer outdoor recreational activities.

**Vision:** By 2010, Eaglecrest Ski Area will be a broadly supported, year-round recreation center with appropriate infrastructure for both public and commercial use.

In 2012 Eaglecrest contracted with the SE Group, North America’s premier ski area master planning firm, to update the Ski Area Master Plan. The SE Group subcontracted with the McDowell Group and performed extensive public research through telephone and online surveys. This survey research included a random sample telephone survey of Juneau residents. The telephone survey was conducted from September 30, 2011, to October 4, 2011, and included a sample size of 449 adults. The survey is statistically representative of the overall Juneau adult population, with a maximum margin of error of ± 4.5% at the 95% confidence level.

**Chart 2:  
Eaglecrest Development Options – Ranked as Most Important**

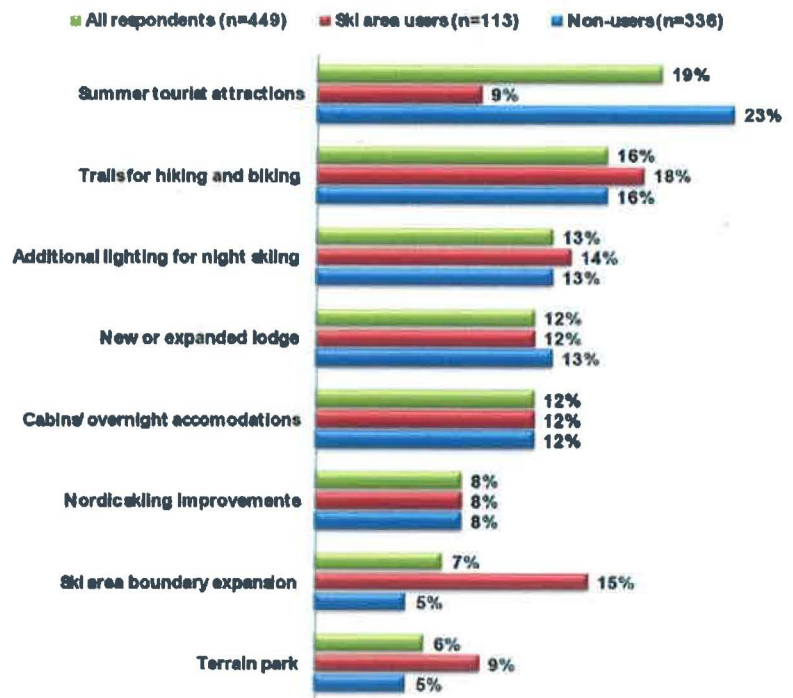

The two charts shown here reflect the top choices from the community for development options ranked as Most Important and Very Important. From a total response of 449 participants, 67% ranked development of trails for hiking and biking as desired development activities. Summer tourist attractions closely followed in second place with a total combined score of 64%.

**Chart 1:  
Eaglecrest Development Options – Percent Ranking Very Important**

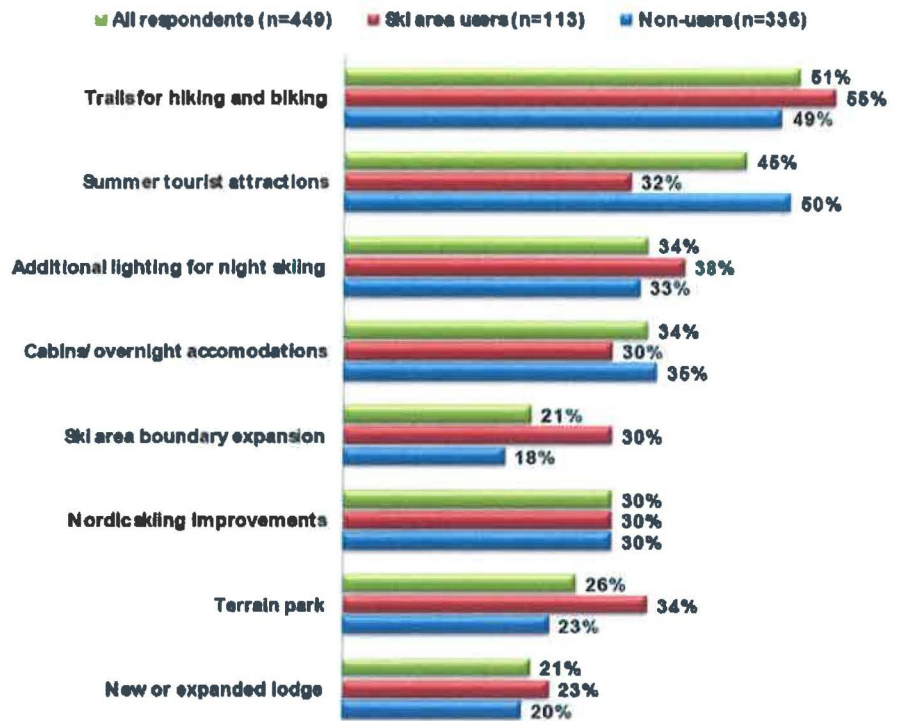

Eaglecrest Ski Area began planning the expansion of operations into the summer months in the fall of 2018, contracting with Gravity Logic to conduct a comprehensive analysis and design a trail system layout for exclusive use by gravity

powered mountain bikes. By the spring of 2019, the Eaglecrest Board and General Manager expanded their planning to design a full suite of summer outdoor recreation activities that would include these mountain bike trails. Official public outreach began on July 1, 2019, when Eaglecrest presented their plans to the CBJ Public Works and Facilities Committee and the North Douglas Neighborhood Association. Multiple additional public outreach meetings occurred throughout the summer of 2019. On October 14, 2019, CBJ Mayor Weldon create the Eaglecrest Summer Operations Task Force to help advance the concept.

**Eaglecrest Summer Operations Task Force Purpose**

The purpose of the task force was to research and explore potential business models for the development of Eaglecrest for summer tourism growth. The goal was to better understand the range of business models, costs, and potential revenues from possible summer operations investments.

The Summer Operations Task Force met seven times between December of 2019 and March of 2022. In total, the Eaglecrest Board of Directors and General Manager hosted 40 public meetings where Summer Operations or the Gondola topic was discussed. Eaglecrest also solicited opinions on desired activities via a public survey hosted on the Eaglecrest Website. A specific Summer Operations web page was also launched in 2019 where planning documents and financial

projections were posted for the public to view. Shortly before the Assembly took public comment on the ordinance to approve the purchase of the Gondola, the Eaglecrest General Manager hosted a public webinar that included an extensive questions and answer session. Below you will see the traffic spike to the website and statistics from participation in this webinar. We were able to estimate that between 150 and 200 people attended the live webinar. This is very high attendance for CBJ Capital Project Public Meetings.

**Eaglecrest 2020 Survey:**

**Q5 What summer activities would you explore if offered at Eaglecrest?**

Answered: 147 Skipped: 0

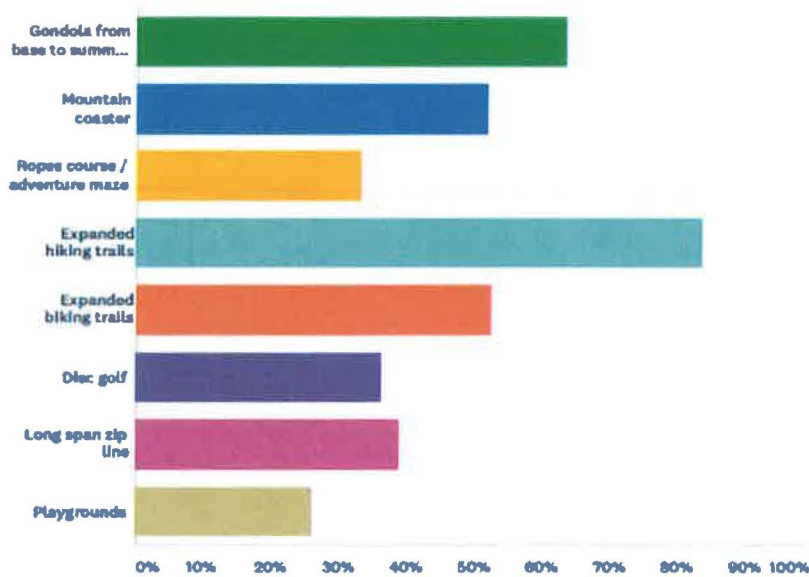

ANSWER CHOICES	RESPONSES	
Gondola from base to summit (Pittman's Ridge)	63.27%	93
Mountain coaster	51.70%	76
Ropes course / adventure maze	33.33%	49
Expanded hiking trails	83.67%	123
Expanded biking trails	52.38%	77
Disc golf	36.05%	53
Long span zip line	38.78%	57
Playgrounds	25.85%	38
Total Respondents: 147		



**Eaglecrest Gondola Webinar and Information Webpage activity:**

**EAGLECREST SUMMER DEVELOPMENT PAGE - RECENT ACTIVITY**



**WEBINAR RECORDING - VIEWS**



**Pulse Gondola Webinar + Q&A | 2.23.22**  
 201 views • Feb 25, 2022 • Dave Scanlan presents the case for the

**WEBINAR - LIVE VIEWS**

During the public webinar + Q&A session, we noticed a peak attendance of 138 participants on zoom; some people left early and others joined the meeting late. While we do not have an exact number, we estimate that between 150-200 Juneau residents tuned in live for at least part of the webinar.

**Long Term Financial Sustainability of Eaglecrest:**

The primary reason that Eaglecrest has pursued expansion of operations into the summer season is to ensure the long-term viability of the ski area. Eaglecrest is structured as a Special Revenue fund through CBJ, which means that the Ski Area is not intended to turn a profit year over year and will rely on CBJ General Funds. Thanks to CBJ Assembly investment in improving Eaglecrest’s snowmaking infrastructure, Eaglecrest has been able to grow usage patterns and revenue even in the face of erratic weather that has historically had a very negative impact on annual revenue.

Even though Eaglecrest has grown revenue, they have also had to grow the annual CBJ General Fund support to be able to keep up with the increasing fixed costs of ski area operations, record high inflation on goods and services, and dramatic increases to labor costs.

Despite recent increases to base wage rates, Eaglecrest continues to pay below ski industry norms for most positions and expects to continue to see increases in labor expense to retain and recruit skilled staff necessary to operate the area. Eaglecrest is now in its 46<sup>th</sup> year of operations and as such, the physical plant will need major capital investment over the next 10 years to update the aging primary ski lifts. In collaboration with the City Manager and Finance Director, we have not been able to find a capital plan that would fund the needed \$10 to \$15 million dollars needed for ski lift upgrades without creating new revenue.

**Purchase of Pulse Gondola from Austria:**

After the onset of the COVID 19 Pandemic, the Eaglecrest Board instructed the General Manager to continue efforts to move forward with finding capital partners and begin the shift into year round mountain operations. In November of 2021, the Eaglecrest Manager was contacted by a sales associate from Steel Head Systems and notified of a high-quality fixed grip gondola that was going to be decommissioned and sold in May of 2022. In December, the Eaglecrest Manager began working with Assembly Member Bryson on a funding package to purchase the gondola, provide for its transportation from Austria to Juneau and perform preliminary engineering for installation at Eaglecrest. Ordinance 2021-08(b)(am)(z) funding the purchase of the gondola was introduced at the February 7, 2022, Assembly meeting. The Assembly received public testimony at the February 28, 2022, meeting, and subsequently approved the ordinance funding the purchase of the gondola.

Shortly after the Assembly approved the purchase of the gondola, Goldbelt Inc., Juneau's urban Native Alaska Corporation, contacted the Eaglecrest Manager and expressed interest in being a capital partner to install the gondola and construct the Summit House and trail system. Over the course of the last year, the Eaglecrest Manager has worked the CBJ City Manager, CBJ Legal Counsel, and the Goldbelt Executive Team and their Legal Counsel to enter into a Revenue Sharing Agreement in exchange for \$10 Million dollars in development capital. It is expected that this process will be completed in its entirety, including an appropriation of \$10M in spending authority, by June 9, 2023.

**Consistency with the CBJ Comprehensive Plan:**

Eaglecrest's Gondola and Summit House installation and expansion into Summer Operations is supported within many sections of the CBJ Comprehensive Plan. Sourcing funding for infrastructure improvements through public private partnerships is mentioned multiple times. Below are some examples of the sections of the Comprehensive plan where you will find this

support for Eaglecrest's expansion into summer operations and attracting additional capital through public private partnerships (*emphasis added*).

#### **Chapter 5: Tourism and Visitors – Winter Tourism**

Juneau has potential to develop as a winter tourism destination, with attractions such as winter scuba diving and more traditional winter sports attracting increasing numbers of visitors. Efforts to promote Eaglecrest as a year-round outdoor recreation destination in Juneau and the surrounding region should continue. Improvements have been made to upgrade the lodge building, the parking area, chair lifts and the ski trails, all of which have increased Eaglecrest's appeal as a winter destination. Private-public partnerships have been developed recently - and should continue to be cultivated - to provide summer season activities to extend enjoyment of the area year round.

#### **Chapter 5: Policy 5.6 and SOP 4**

- TO ENCOURAGE TOURISM, CONVENTION AND OTHER VISITOR-RELATED ACTIVITIES THROUGH THE DEVELOPMENT OF APPROPRIATE FACILITIES AND SERVICES, WHILE PROTECTING JUNEAU'S NATURAL, CULTURAL AND ECONOMIC ATTRACTIONS FOR LOCAL RESIDENTS AND VISITORS ALIKE, AND TO PARTICIPATE IN THE ACCOMMODATION OF THE FUTURE GROWTH OF TOURISM IN A MANNER THAT ADDRESSES BOTH COMMUNITY AND INDUSTRY CONCERNS.
- 5.6 - SOP4 Develop Eaglecrest as a year-round local and regional recreation and tourist facility

#### **Chapter 8: Transportation: North Douglas**

Over the years, North Douglas Highway has experienced increased traffic from recreational users of North Douglas lands, shorelines and waters, in addition to increased resident traffic. Increased traffic is dangerous for pedestrians, joggers, bicyclists and students awaiting school bus service. The boat launch on the north shore of Douglas Island offers many recreational enthusiasts and visitors a world class, spectacular view scape of the Mendenhall Glacier and access to world class fishing. Eaglecrest is working to be a year-round outdoor recreation destination. In the years ahead, additional traffic associated with a North Douglas bridge connecting the West Douglas New Growth Area to the mainland may have impacts to the North Douglas Highway traffic capacity and safety, depending on the timing and intensity of development in West Douglas, the location and design of the bridge or crossing landing, and the location and type of roadway(s) leading to and from West Douglas. [Please also refer to Chapter 11, Subarea 9 North Douglas Highway and channel crossing discussions.]

## **Chapter 9: Parks, Recreation, Trails and Natural Area Resources: Opening Narrative**

The Eaglecrest ski area, located on Douglas Island, is an important winter recreational resource to many Juneau families. The management of the facility is seeking ways to provide year-round recreational activities for residents and visitors to make more efficient use of its resources.

The Capital Improvement Program Six-Year Plan includes a prioritized listing of Parks and Recreation, Eaglecrest, and Centennial Hall projects. Funding is provided primarily through the CBJ budget, with occasional state funding through the legislative process. Other sources of funding should continue to be pursued.

## **Chapter 9: Policy 9.1 and Implementing Action 24: Policy 9.1**

TO PROVIDE QUALITY DISPERSED OUTDOOR RECREATIONAL OPPORTUNITIES AND TO ACQUIRE AND DEVELOP SUFFICIENT LOCAL PARKS AND RECREATIONAL FACILITIES IN LOCATIONS CONVENIENT TO ALL AREAS OF THE CBJ. PLACES GIVEN PRIORITY FOR NEW FACILITIES INCLUDE RAPIDLY DEVELOPING AREAS AND CURRENTLY DEVELOPED AREAS THAT LACK ADEQUATE PARKS AND RECREATION FACILITIES.

9.1 - IA24 Encourage development of additional facilities at, and provision of electric energy from the CBJ's existing electrical grid to the Eaglecrest ski area.

## **Subarea 8: North and West Douglas Island: Guidelines for Subarea 8**

11. As much as is practical and efficient, coordinate recreational and maintenance activities and shared use of facilities and equipment and coordinate management activities with the Eaglecrest Facility and programs. Many of the facilities at Eaglecrest can serve both skiers and non-skiers and both winter and off-season recreational activities and events. Shared use and year-round use of the Eaglecrest facilities and lands should be encouraged and facilitated.

### **Gondola Specifics:**

Gondolas are a form of Aerial Conveyance typically found at ski areas and other tourist attractions. Per CBJ Title 49 land use code, with Eaglecrest being zoned Rural Reserve, Aerial Conveyance is allowed with a conditional use permit. Eaglecrest is home to Juneau's only ski area and currently has four aerial ropeway systems. The fixed Grip Pulsing Gondola that Eaglecrest will install has 12 enclosed cabins, each with a capacity of 15 passengers. The cabins will be configured into four pods of three cabins that will circulate on one fixed haul rope. The lift system, in this 4x3 configuration, will have a maximum capacity of 750 passengers per hour. The total ride time from bottom to top will take 7.5 minutes. There will be a midway station that will allow summer and winter passengers to load and unload mid-mountain. The pods will be arranged along the haul rope such that when the gondola stops all cabins will be at one of the three stations. The gondola will come to a complete stop for 45 seconds, allowing the passengers to load and unload.

The base station will be located adjacent to the Hooter Chair Lift base station at GPS coordinates 58°16'31.90"N - 134°30'52.52"W at an elevation of 1178 feet. The midway loading/unloading station will be located at GPS coordinates 58°15'57.99"N - 134°31'06.69"W at an elevation of 1734 feet. The top station will be located at GPS coordinates 58°15'25.22"N - 134°31'20.39"W at an elevation of 2710 feet. The gondola will have a horizontal length of 6,934 feet with a vertical gain of 1,588 feet. In addition to the base, mid and top stations, twenty-one vertical support towers will be required to support the gondola rope.

The gondola base station consists of a steel platform for queuing of loading and unloading passengers. The electric drive mechanism and hydraulic rope tensioning system are integral to the base station. The accompanying photo of the base station in Austria shows these features (see below). The Eaglecrest installation will have an operations building immediately adjacent to the loading platform to house the operator station and gondola electrical/controls systems.



A permanently mounted maintenance crane is integral to the base station and located at the end of the loading platform. The crane facilitates servicing and periodic repositioning of cabins along the haul rope. The base station's concrete foundations will be designed to support the addition of a roofed enclosure that could be installed at a future date, should operations dictate its need.

An all-new Midway Station will be constructed at the gondola's halfway point. Initially, the midway station will consist of an unroofed elevated steel grate platform for passenger loading and unloading, with a small operator shack to house the start/stop controls as well as control systems that will open and close the gondola cabin doors. The midway station's concrete

foundation will be designed to support the future addition of a steel roof structure to shelter the station from rain, snow, and ice. It is anticipated that construction of the midway station roof will occur sometime after the gondola is in operation, with timing dependent on budget constraints.

Like the base and midway stations, the summit station will also have steel platforms for passenger queuing during loading and unloading, and an adjacent operator's station. The summit terminal station will be fully enclosed by a steel framed structure that will be accented with tongue and groove wood paneling. This enclosure will be critical to the function of the Gondola as the summit station location is an area that is exposed to high winds and experiences regular rime icing events. The enclosure will protect critical machinery e.g., bullwheel and door opening mechanisms, and the three gondola cabins that will be parked at the summit terminal at nights, during storm events and during periods when the gondola is otherwise not operating. The wind protection that the enclosure will provide during operations will shelter the cabins as they dock, allowing the lift to run in higher winds than would be possible if the enclosure was not constructed. This structure will be designed to be built in two phases, with phase I being the construction of just the protective enclosure around the gondola terminal, and phase II being construction of the adjoining Summit House warming hut.

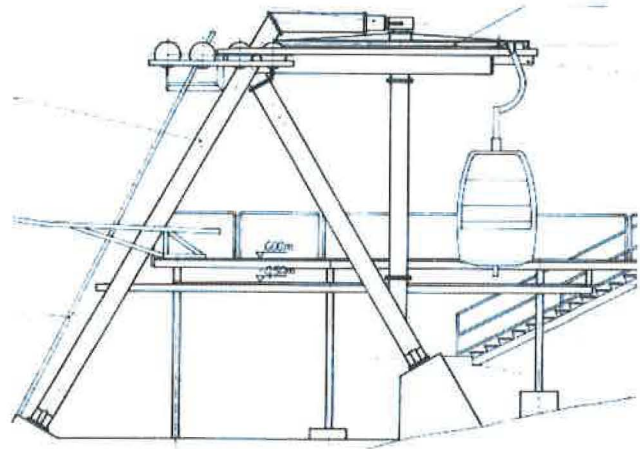

Temporary relocatable structure(s) will be employed at the top terminal for seasonal shelter for summer patrons in the event the Summit House construction is delayed a season.



### **Summit House Warming Hut:**

The Summit House will be utilized during both the summer and winter operating seasons. It will be integrated into the top terminal enclosure and be of similar construction – steel framed with wood paneling accents. The building will have 4,000 square feet of indoor space that will accommodate restrooms, banquet style food service area, small bar for beer and wine sales, and a large general seating area (the Great Room). All food preparation will be done in the Fish Creek Lodge’s certified kitchen and transported to the Summit House in the Gondola cabins. Large decks on the South, West and North aspects of the building will allow guests to take in the panoramic mountain top views of Admiralty Island National Monument, Stephens Passage, Seymour Canal, Hogsback Mountain, Cropley Lake and Mt Ben Stuart. The entirety of the building will be constructed on Eaglecrest land, setback 25-ft from the property line between Eaglecrest and the neighboring State Land. The building will have a propane fueled fireplace to add ascthetic value to the great room and the exterior deck.

Water and wastewater systems for the summit house have yet to be designed. It is anticipated that a rainwater catchment and storage system will likely provide for all non-potable water needs of the building. A fire supression water storage tank and fire pump will be located in the utility room in the basement of the structure. Initaly, potable water will be sourced from the Eaglecrest water treatment plant and transported to the summit house in approved containers loaded into the gondola cabins during the winter months or transported to the top via a transport vehicle during the summer months.

It is likely the toilet facilities will consist of high-end Clivus composting toilets similar to those found in the Eagles Nest, with all black water and solids composted or pumped off site. Grey water will likely be treated with an onsite drain field.

The building will ultimately be connected to AEL&P electricity, although a generator may be used initially.

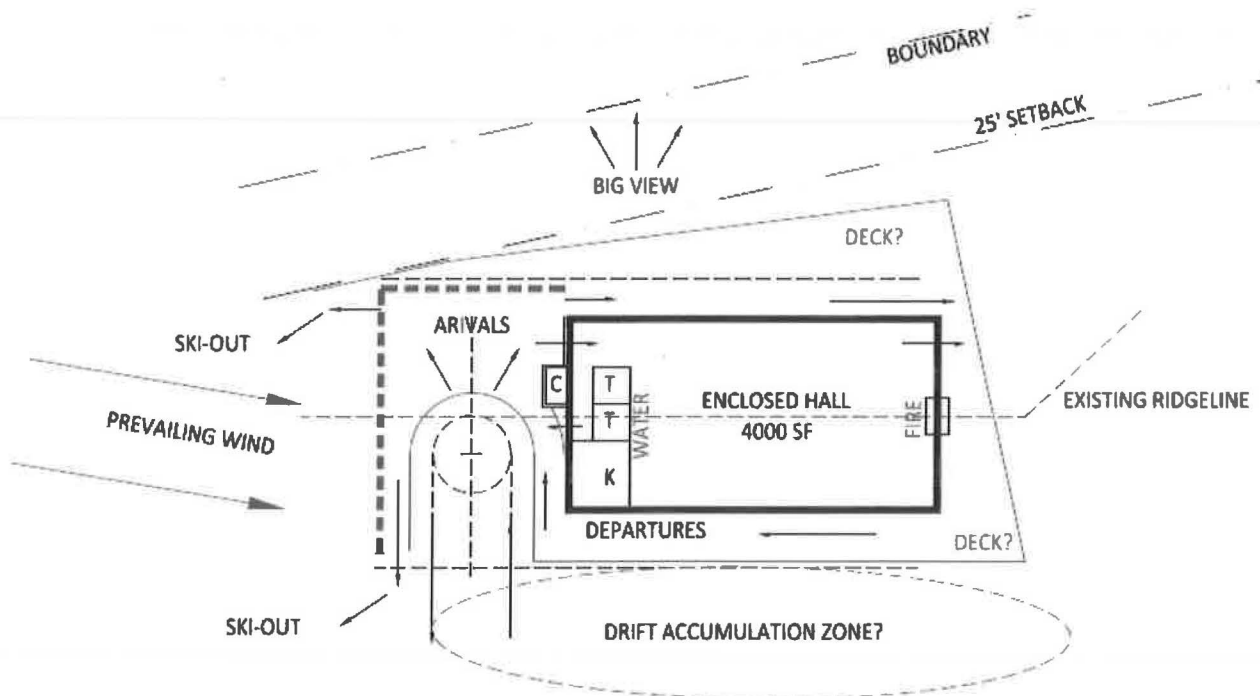

**FLOOR PLAN**

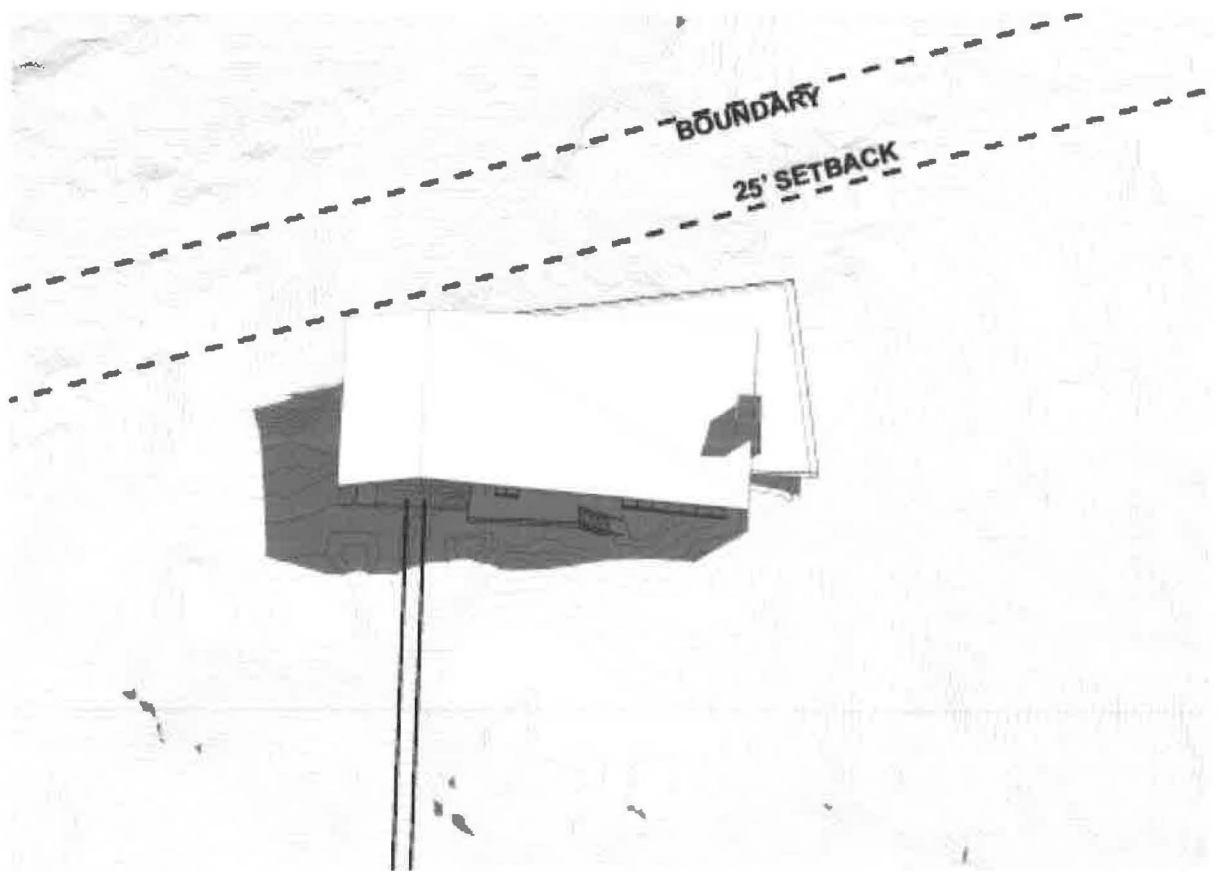





**Picnic Pavillion at Cropley Lake:**

A Timber Framed Post and Beam Picnic Pavillion will be constructed at Cropley Lake. The structure will be primarily for summer use. The open structure will have a crushed gravel floor and a footprint of approximately 25 feet by 50 feet. This structure will have design elements similar to the picnic pavillions installed at Auke Recreation Area, Lena Cove and Auke Lake. The pavillion will have a large propane fueled fire pit where guests could roast S'mores while enjoying the views of Cropley Lake, Mt Ben Stuart and Hogsback Mountain. A concrete vault outhouse will be constructed adjacent to the pavillion site. A gravel road will be constructed from the gondola midway station to provide vehicular access to the site. The site will not have electrical service.

**Construction Access Roads:**

Three new primary access roads are required for the construction of the Gondola and Summit House. These roads will also provide postconstruction access for mountain activities and ongoing operations and maintenance.

**Top Station Road –**

A new 3,000-ft long, 16-ft wide access road will be constructed between the top of the Black Bear Chair (the end of the summer road) and the top terminal of the gondola. The route generally follows the skiers' winter hiking route from the top of Black Bear to the ridge above West Bowl, then follows the ridgetop westwards to the gondola terminal site. The area is alpine in nature with exposed rock along the route. Rock blasting will be required in places to form the road bed. The majority of rock needed to construct this road is expected to be generated from road cuts along the route, including a significant rock cut at  $58^{\circ}15'26.14''\text{N} - 134^{\circ}31'09.18''\text{W}$ . Additional rock will be sourced from the nearby established borrow site at the top of the Williwaw ski trail at  $58^{\circ}15'39.05''\text{N} - 134^{\circ}30'29.31''\text{W}$ . Blasting will also be required at this site.

**Mid Mountain Road –**

A new 2,600-ft long, 16-ft wide access road will be constructed between the end of the existing road at the top of Hooter Chair and the new gondola midway station. This road will continue on another 2,300-ft to the Cropley Lake Picnic Pavilion. Several shorter construction access tracks will spur off the mid-mountain road as needed for construction access to tower sites. The rock for the mid-mountain road will come from two on-mountain sources: an existing borrow source located at the bottom of the Inside Passage ski run ( $58^{\circ}15'49.87''\text{N} - 134^{\circ}30'09.05''\text{W}$ ), and from a new borrow source to be developed adjacent to the new road ( $58^{\circ}16'05.91''\text{N} - 134^{\circ}30'54.00''\text{W}$ ), a quarter mile in from the road's start near Hooter top terminal. The new borrow source will provide the bulk of the rock needed to build the mid-mountain road, the gondola tower construction access tracks, and for mid-mountain area trail construction. The rock required for site work at the midway station and picnic pavilion will also be sourced from this borrow site.

**Lower Mountain Tower Access Road –**

A new 2,500-ft long road will be constructed at the base of the ski area to provide construction and postconstruction maintenance access to gondola towers 3, 4 and 5. Rock to construct this

road will come from an established existing rock borrow source on Eaglecrest land adjacent to Fish Creek Road, a half-mile from the ski area parking lot (58°17'07.94"N - 134°31'51.07"W). Blasting will be required to produce rock at this site. Rock from this site will also be used for the expansion and hardening of the Lower Nordic Parking Lot located across the road from the rock source.

Additional hardened access trails will be constructed to other gondola tower sites to provide construction and maintenance access. These trails will be suitable for Eaglecrest's ATV and UTV maintenance vehicles.

**Mountain Bike Trail Construction:**

After gondola construction is completed, many of the tower access trails and construction roads will be converted into Mountain Bike and hiking trails. In addition, new trail(s) will be constructed that will bisect the gondola line in as many locations as possible to provide a summer egress route if the gondola ever needs to be evacuated. This trail will require two bridge crossings over nonanadromous Upper Fish Creek that flows out from Cropley Lake. The trail will generally be 8 feet wide and be designed to accommodate ATV/UTV access for maintenance and operational purposes. Only non-motorized use of these trails will be allowed for our guests.

**Snowtubing Park:** There will be a snowtubing park constructed on the slope between the Gondola Midstation and Cropley Lake. The existing Eaglecrest handle tow tubing surface lift will be relocated to provide tube return transportation up the tubing slope. Eaglecrest snowmaking equipment will be utilized to produce large amounts of snow for the snowtubing and snowplay area at the Gondola Midstation. Later in the summer, turf material can be utilized for the tubing lane surface.

**Future Phases of Recreation Activities:**

Once the initial Gondola construction is complete, Eaglecrest anticipates expanding the mountain top visitor experience with the construction of an 1800-ft long pedestrian suspension bridge that will be integrated into the Summit House Top Station. This bridge will necessitate a land use agreement with our neighboring State Land Parcel 8a25. If funding and land use agreements eventuate, Eaglecrest will return to the Planning Commission with an application for a separate CUP for the bridge and other recreation activities.

**Construction Material Borrow Sites and Material Extraction:**

Permission to develop new on-site construction material sources and extraction of materials from new and existing on-site borrow sites is requested as part of the Gondola and Summit House project's overall USE permit (this application) – A separate Sand and Gravel Extraction Permit is not sought.

Borrow site development and extraction activities when carried as part of a larger overall construction project are typically regulated by OSHA as construction activities, not commercial

mining operations regulated by MSHA. The development and extraction activities at this project's numerous on-site material borrow sources is integral to the construction activities associated with the Gondola project e.g., the majority of the top terminal road is expected to be constructed using rock generated from cuts within the road "right-of-way" as well as excess rock produced by site work at adjacent terminal and tower sites. All rock produced at the project's proposed and existing borrow sites will be used exclusively for Eaglecrest development projects. Any rock produced in excess of immediate project requirements will remain stockpiled on site.

Blasting at the project's borrow sites will comply with the CBJ Engineering Department's Standard Specifications for Civil Engineering Projects and Subdivision Improvements SECTION 02090 - BLASTING CONTROLS. Past Eaglecrest projects involving rock blasting have been safely and successfully carried out under these standards.

After extraction, material sites' steep slopes will be cleaned of unconsolidated material and typically backfilled with oversized rock and overburden before being regraded/shaped as needed for safe ski area operation prior to winter ski area operations.

**Project Maps:**

- Eaglecrest Ski Area Gondola & Summit House Site Map
- Parcel Lines and Land Ownership
- Documented Eagle Nest Sites
- Eaglecrest Summer Recreation Development wetland maps – 10 Sheets

# Documented Eagle Nest Sites

Part of Alaska Bald Eagle Nest Sites (USFWS)

Records: 33,806



Kim Homan  
Southeast Alaska GIS Library

## Summary

Location of Bald Eagle Nests, both active and inactive, in portions of Southeast Alaska and surrounding areas.

[View Full Details](#)

[Download](#)

## Details

Dataset  
Feature Layer

May 8, 2019  
Info Updated

May 8, 2019  
Data Updated

May 8, 2019  
Published Date

Records: 33,806  
[View data table](#)

Public  
Anyone can see this content

No License Provided  
Request permission to use

Legend

- Documented Eagle Nest Sites

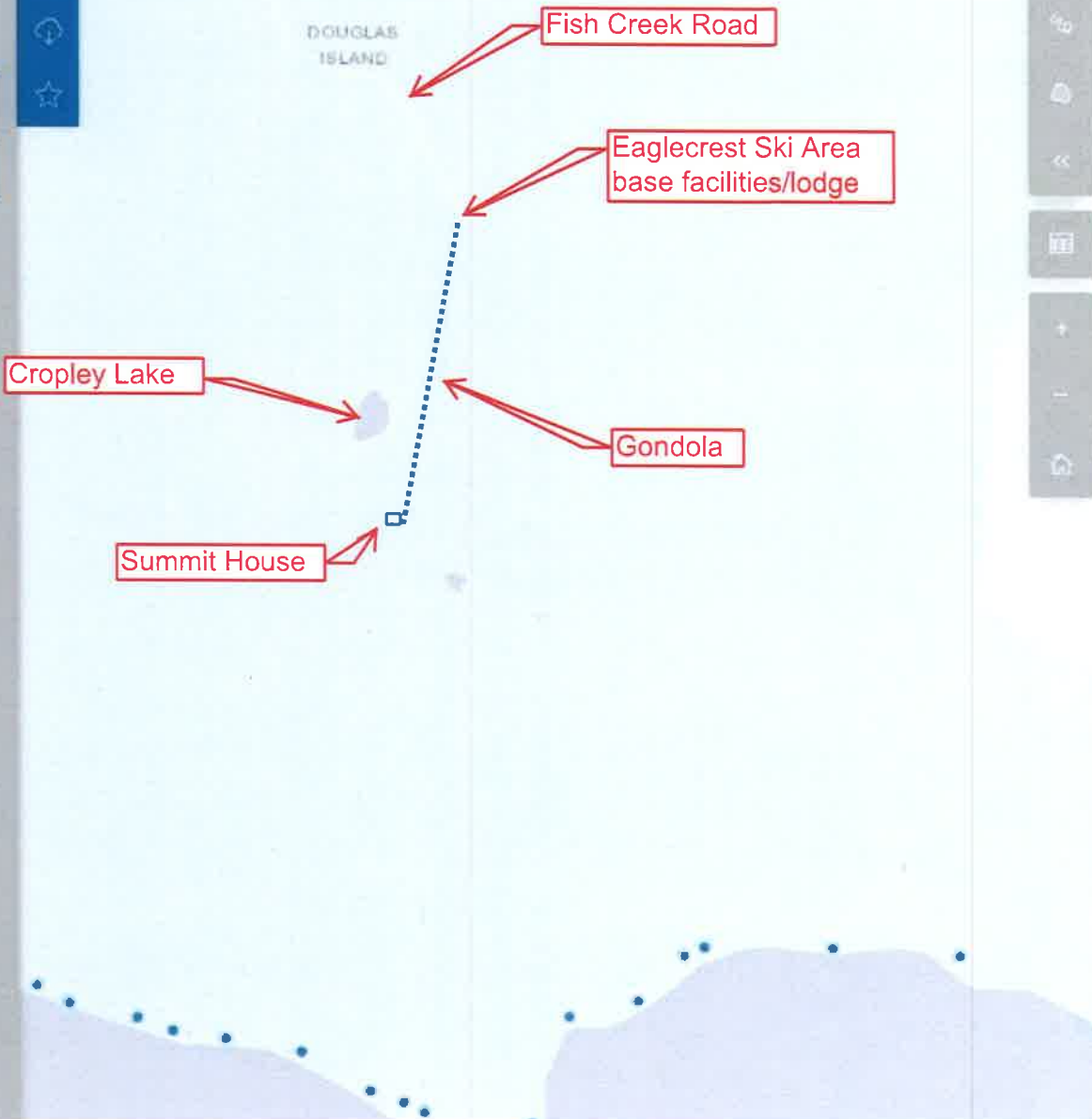

George & c/o Native  
Lands & Resources

Alaska Mental  
Health Trust

DNR

USFS

USFS

DNR

DNR

Eaglecrest  
Ski Area

Gondola

USFS

Parcel Lines and  
Land Ownership

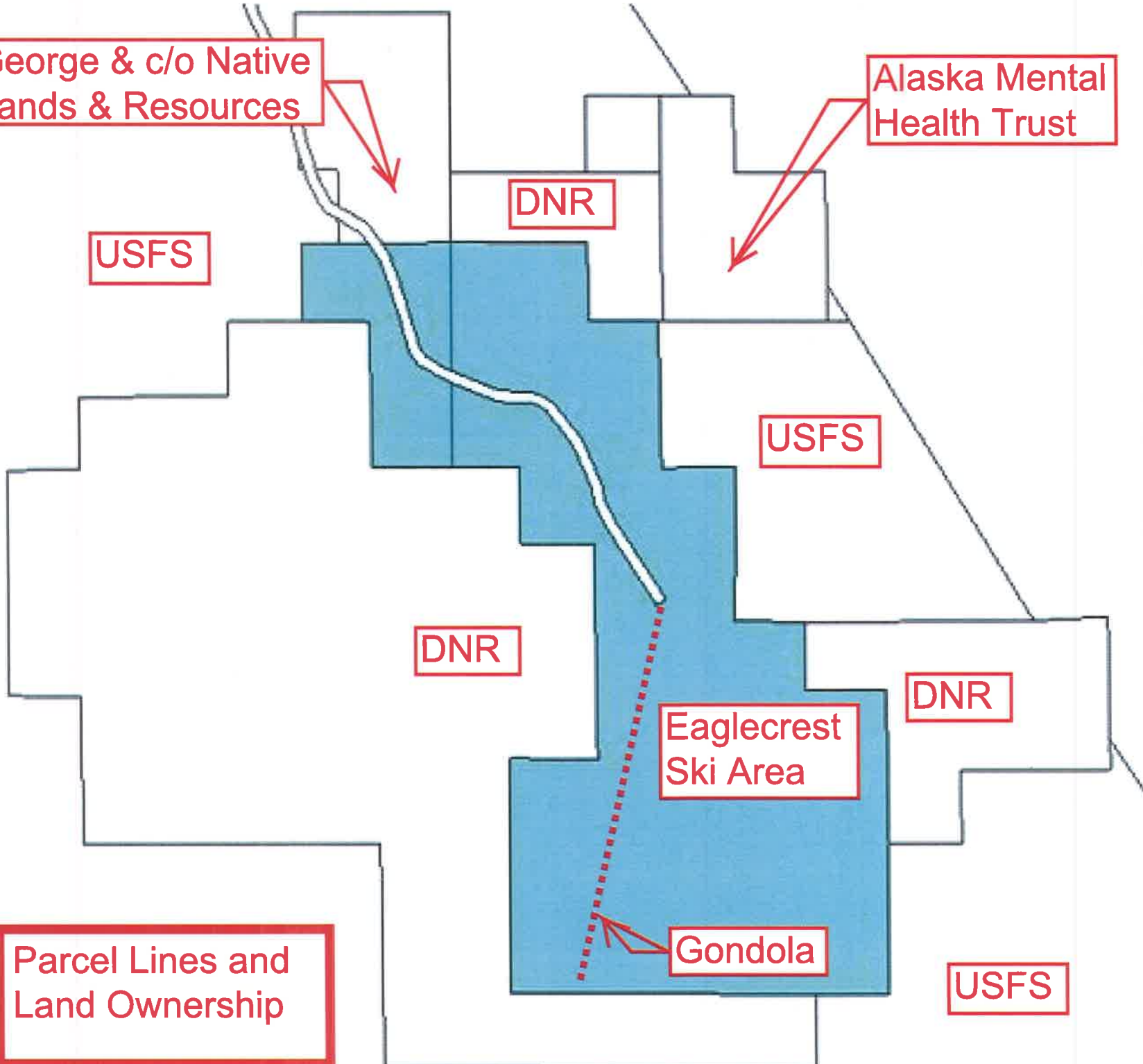

# Eaglecrest Ski Area Gondola & Summit House Site Map

Nordic Parking  
Lot Expansion

Borrow Site

GONDOLA  
Base Terminal

GONDOLA  
Mid Station

Tubing Hill

Cropley Lake  
Picnic Shelter

Borrow Site

GONDOLA  
Top Terminal  
& Summit House

Gondola - Blue  
New roads - Red  
New trails - Magenta

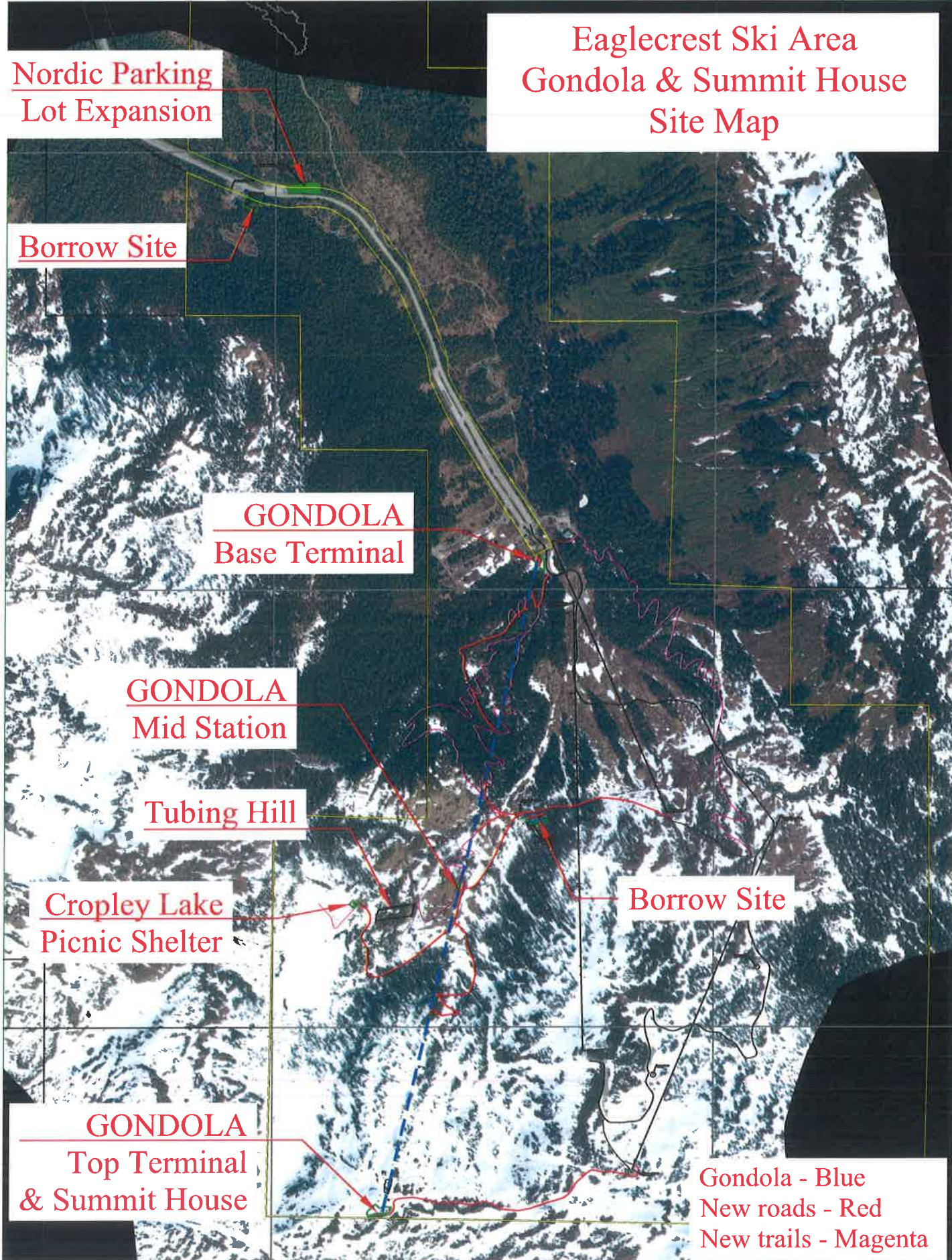

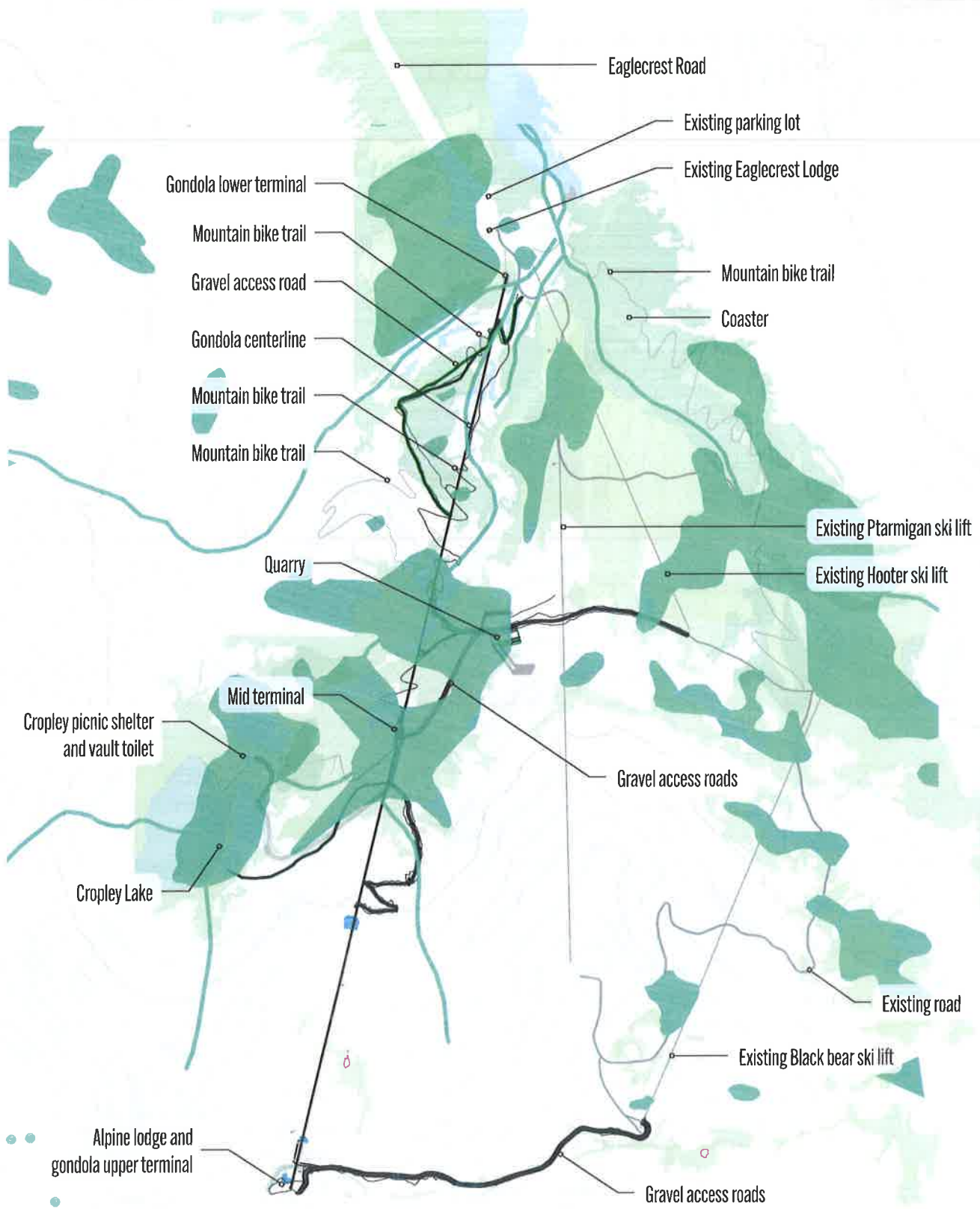

**LEGEND**

NWI: Wetlands  
 NOTE: Wetlands delineated by CBJ and Corvus  
 Design are shown faded in the background.

**EAGLECREST SUMMER RECREATION DEVELOPMENT**





LEGEND

- CBJ: Fen Marsh
- CBJ: Forested Wetland
- CBJ: Open Peatland
- CBJ: Wetlands Floodplain
- Additional wetlands delineated by Corvus Design, 09-15-2022.

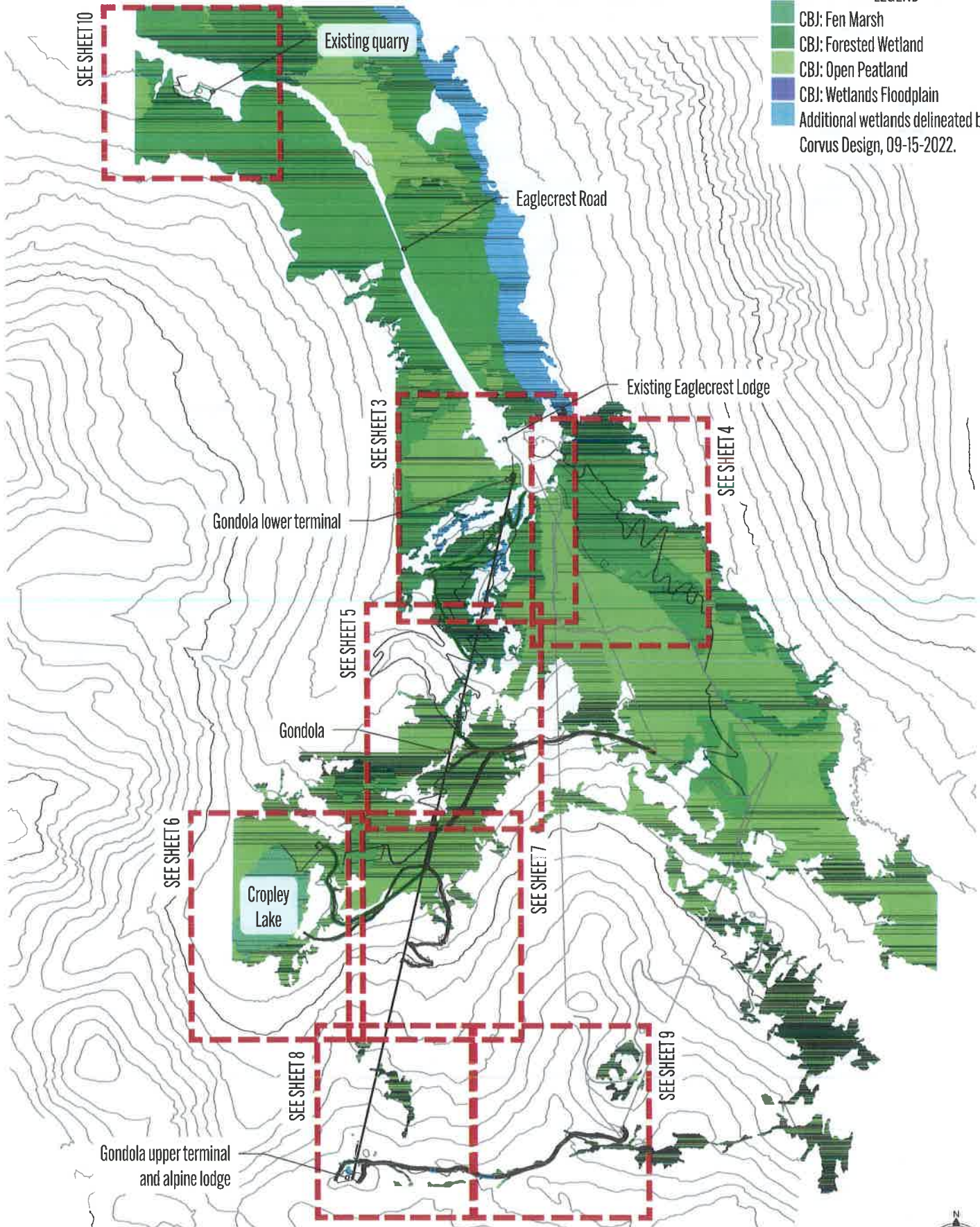

**EAGLECREST SUMMER RECREATION DEVELOPMENT**

SHEET #2

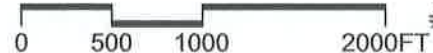

LEGEND

- CBJ: Fen Marsh
- CBJ: Forested Wetland
- CBJ: Open Peatland
- CBJ: Wetlands Floodplain
- Additional wetlands delineated by Corvus Design, 09-15-2022.

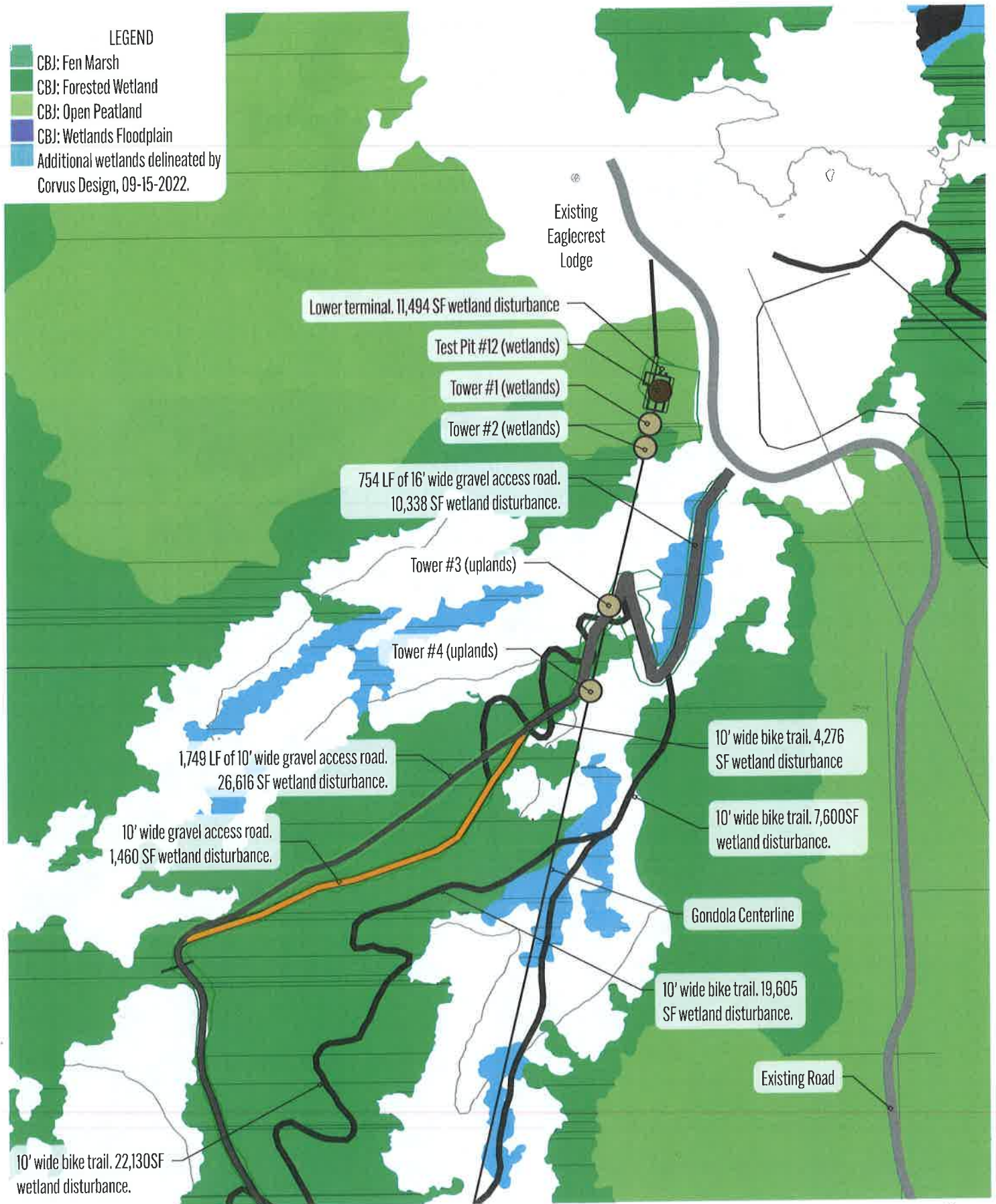

**EAGLECREST SUMMER RECREATION DEVELOPMENT**

SHEET #3



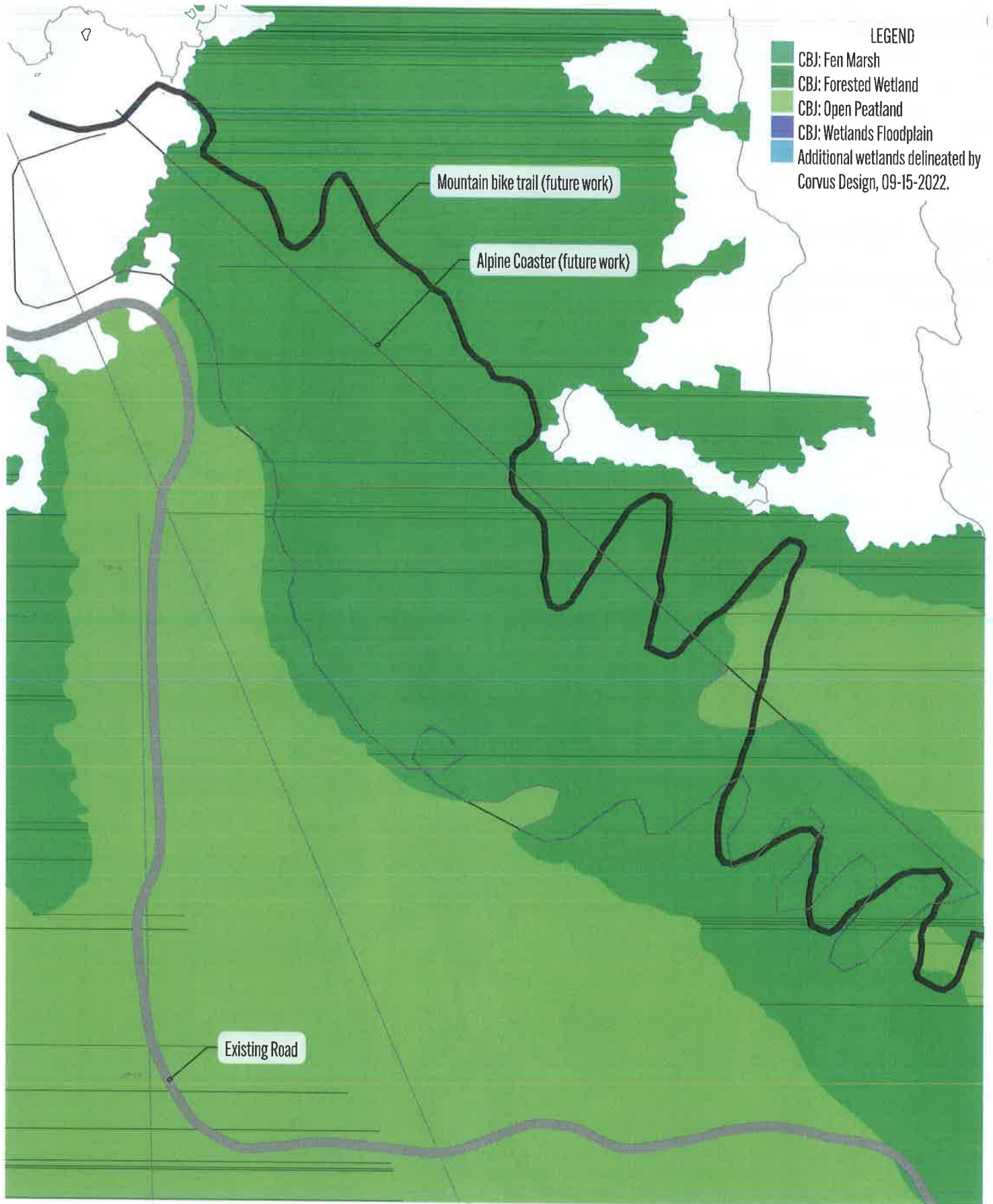

**LEGEND**

- CBJ: Fen Marsh
- CBJ: Forested Wetland
- CBJ: Open Peatland
- CBJ: Wetlands Floodplain
- Additional wetlands delineated by Corvus Design, 09-15-2022.

Mountain bike trail (future work)

Alpine Coaster (future work)

Existing Road

**EAGLECREST SUMMER RECREATION DEVELOPMENT**

SHEET #4



LEGEND

- CBJ: Fen Marsh
- CBJ: Forested Wetland
- CBJ: Open Peatland
- CBJ: Wetlands Floodplain
- Additional wetlands delineated by Corvus Design, 09-15-2022.

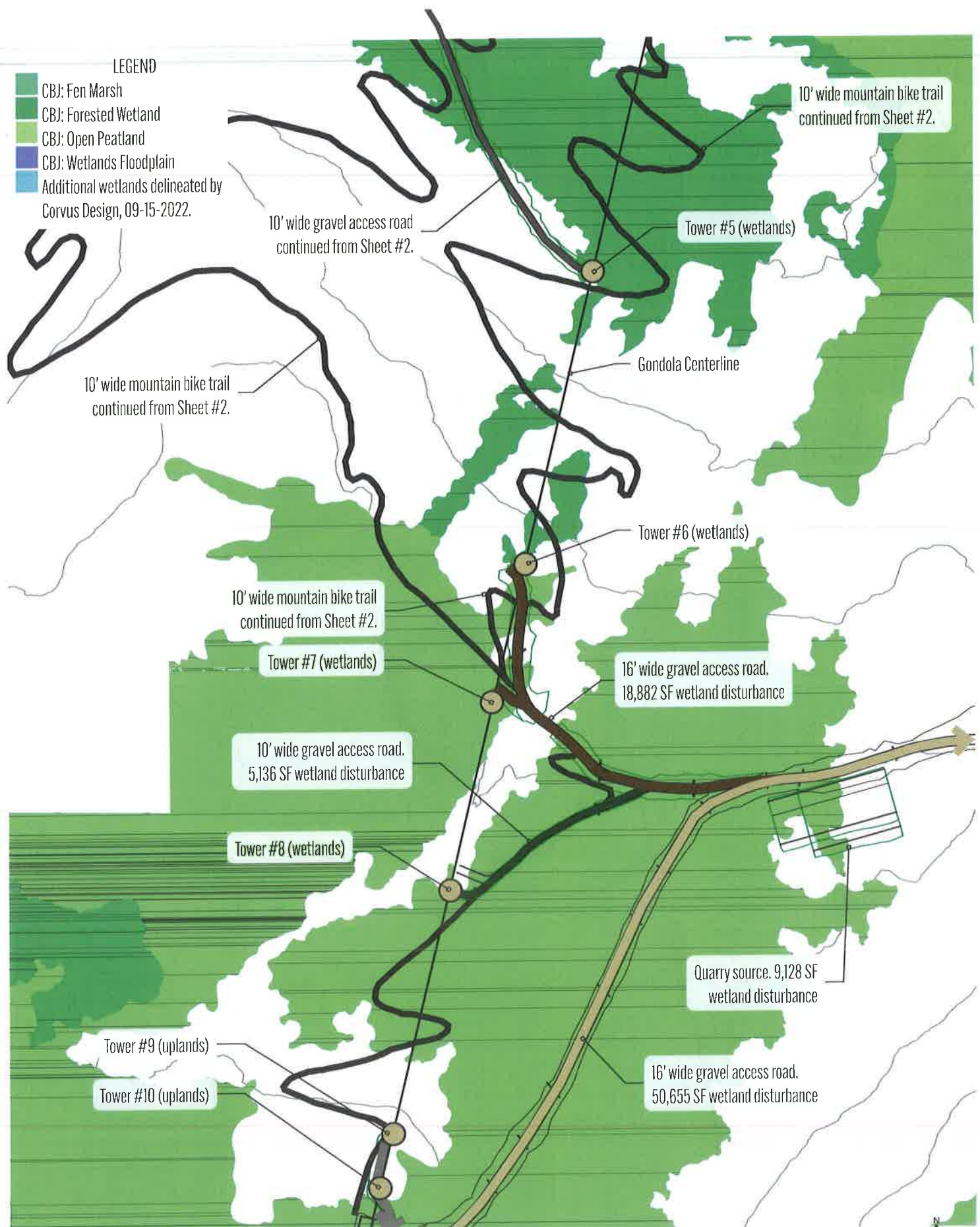

**EAGLECREST SUMMER RECREATION DEVELOPMENT**

SHEET #5



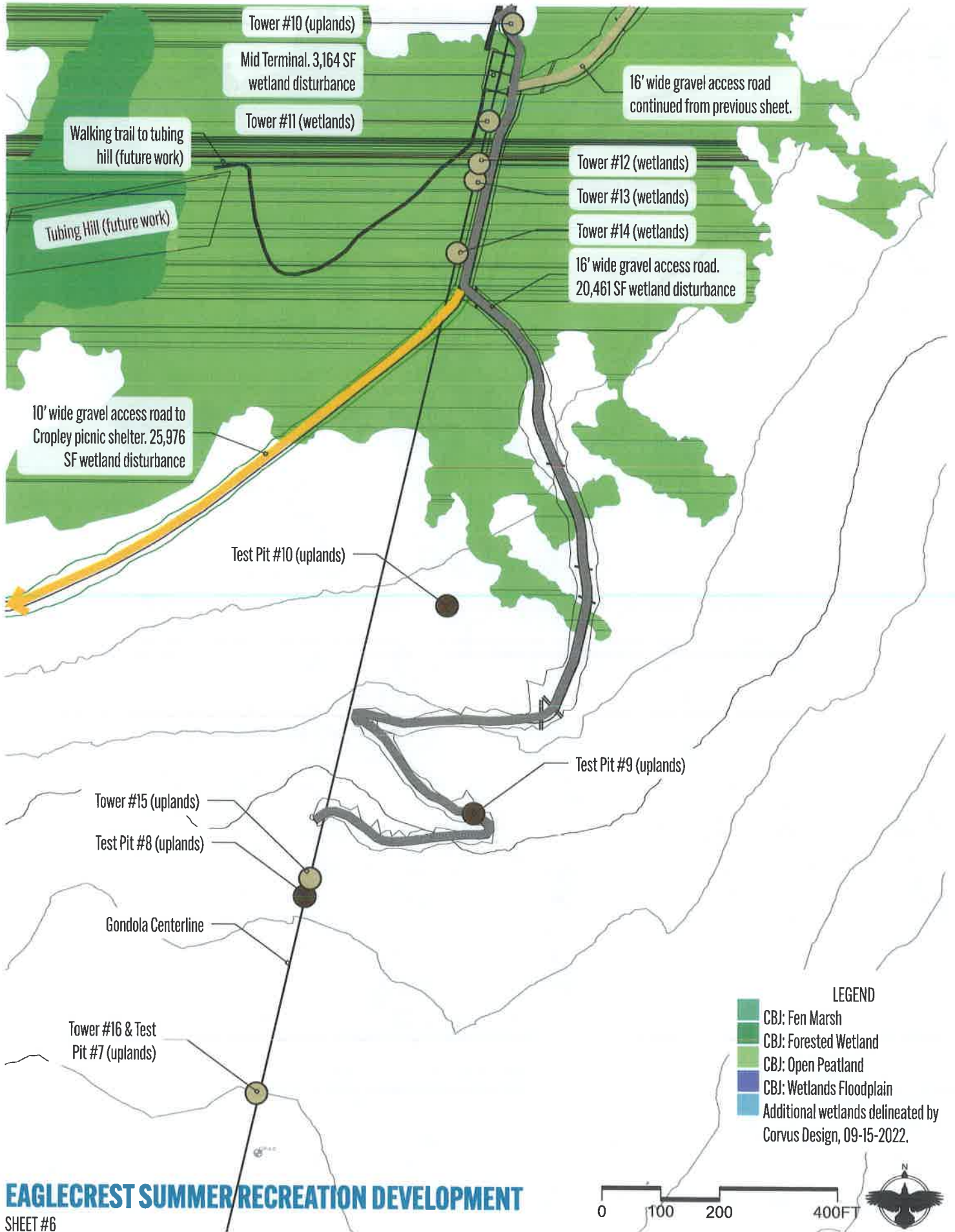

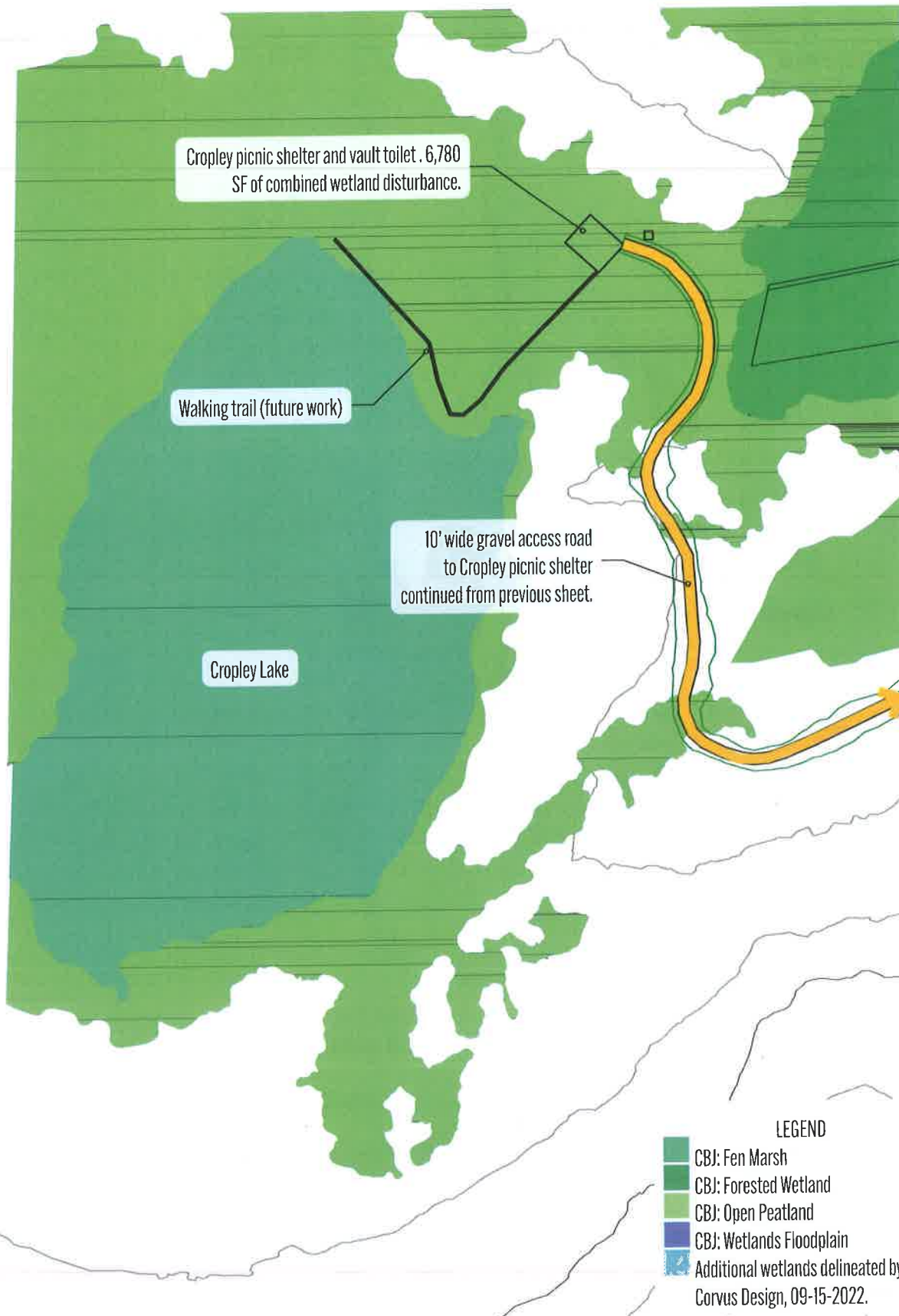

LEGEND

- CBJ: Fen Marsh
- CBJ: Forested Wetland
- CBJ: Open Peatland
- CBJ: Wetlands Floodplain
- Additional wetlands delineated by Corvus Design, 09-15-2022.

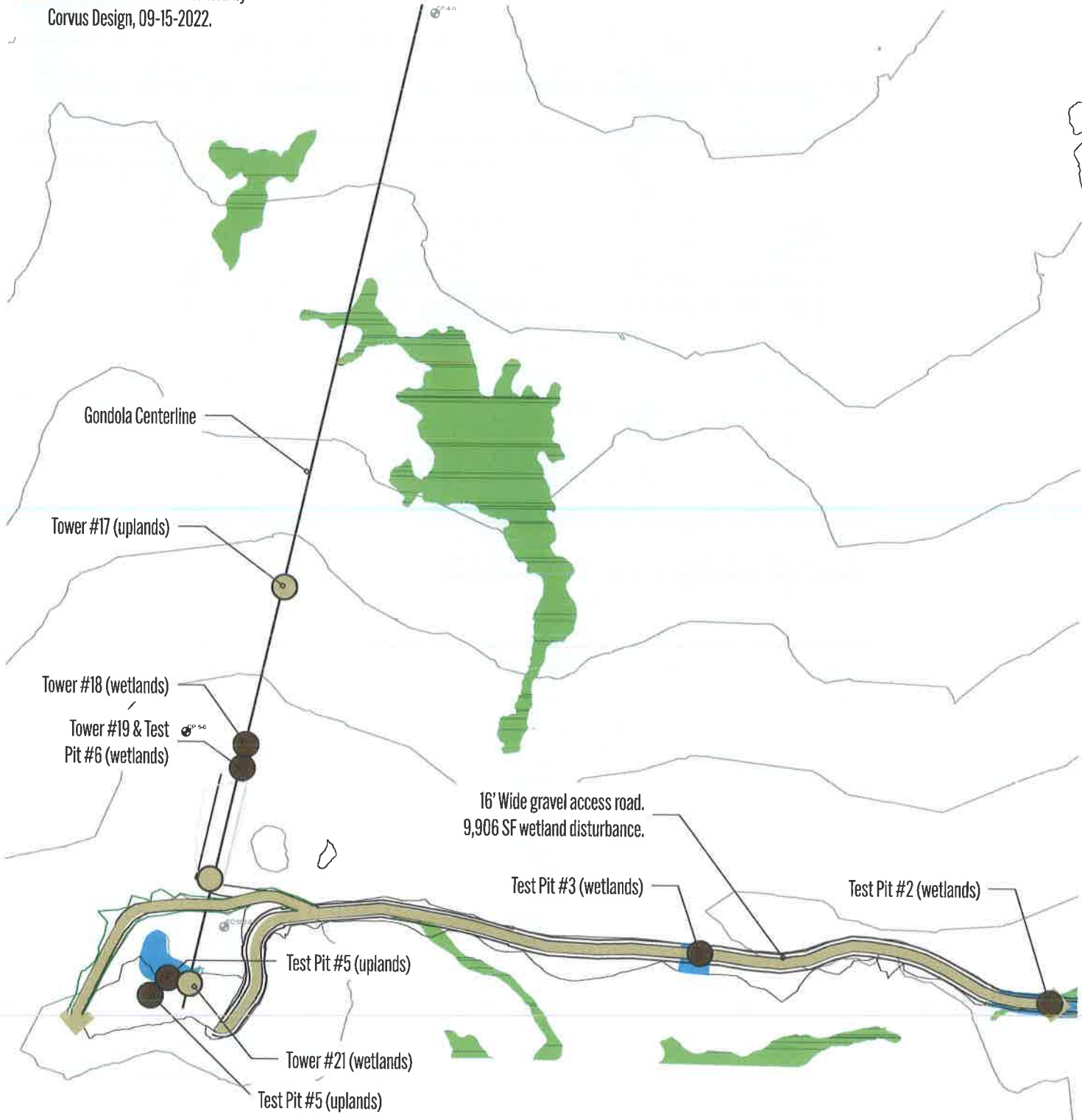

LEGEND

- CBJ: Fen Marsh
- CBJ: Forested Wetland
- CBJ: Open Peatland
- CBJ: Wetlands Floodplain
- Additional wetlands delineated by Corvus Design, 09-15-2022.

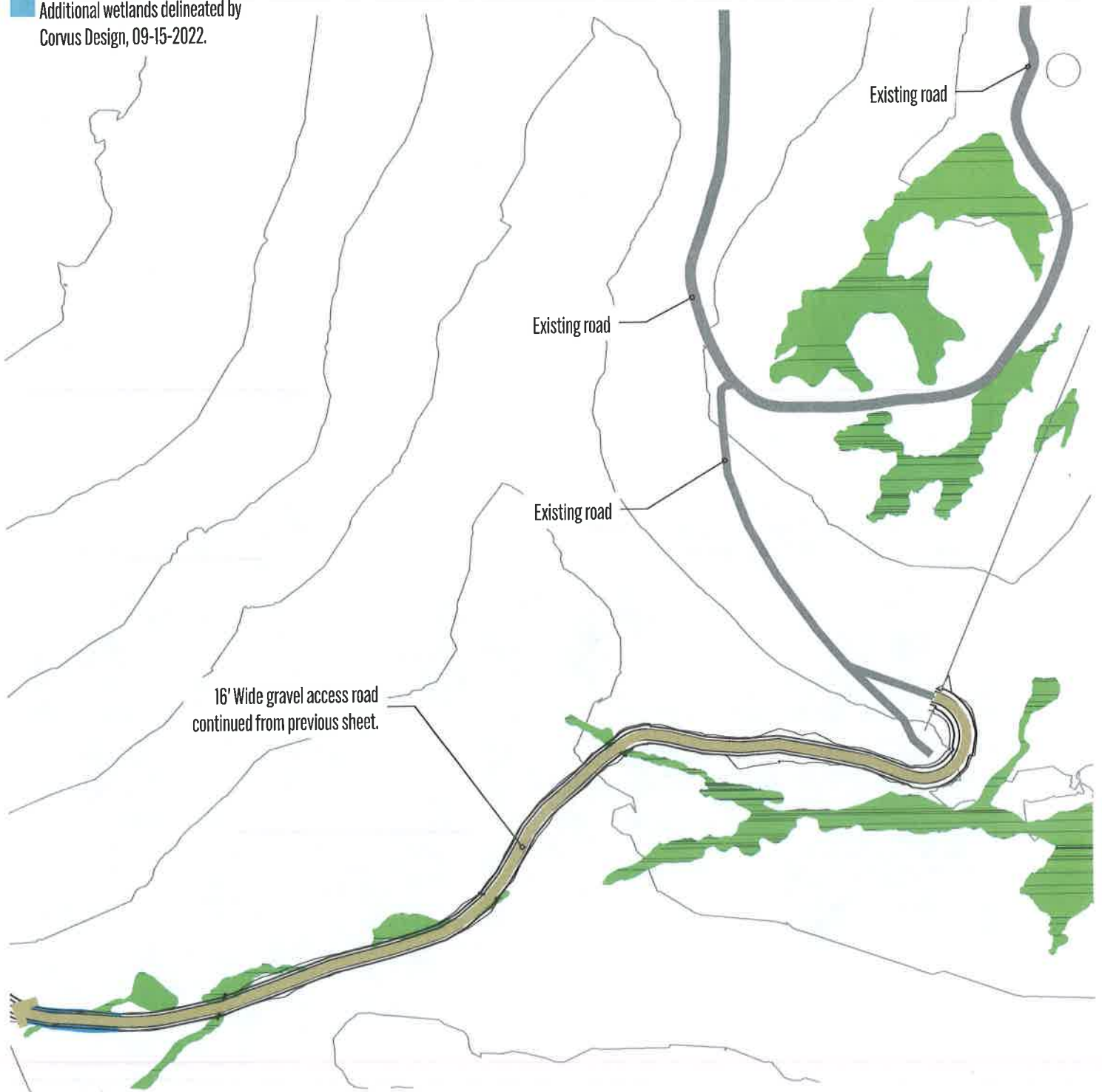



LEGEND

- CBJ: Fen Marsh
- CBJ: Forested Wetland
- CBJ: Open Peatland
- CBJ: Wetlands Floodplain
- Additional wetlands delineated by Corvus Design, 09-15-2022.

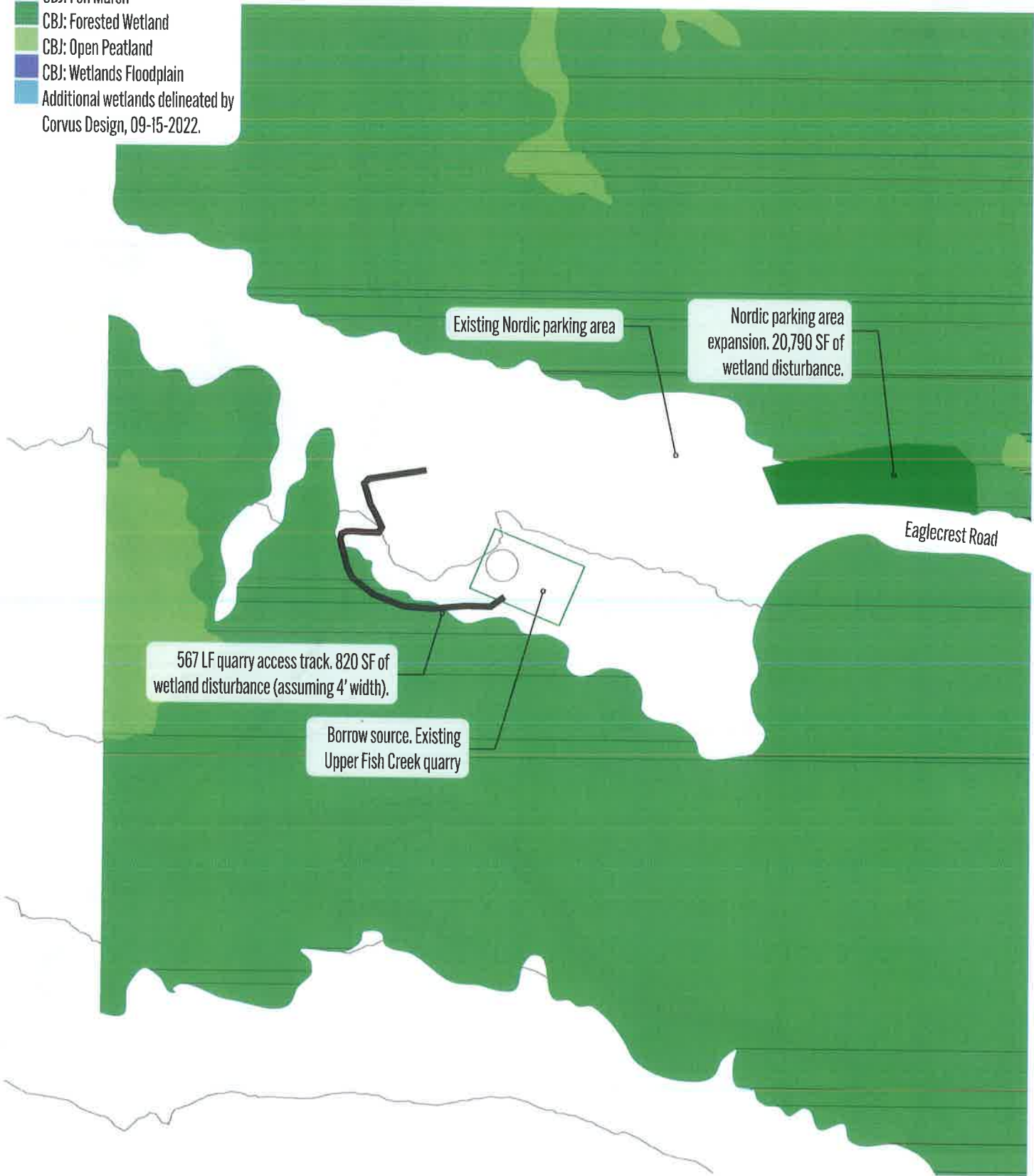



(907) 586-0715  
 CDD\_Admin@juneau.org  
 www.juneau.org/CDD  
 155 S. Seward Street • Juneau, AK 99801

## Eaglecrest Gondola and Summit House

Case Number: PAC2022-40

Applicants: Alan Steffert and Dave Scanlan

Property Owner: City and Borough of Juneau, c/o Lands and Resources

Property Address: 2996 and 3000 Fish Creek Road

Parcel Code Number: 3D1021000010

Site Size: 59,982,120 square feet (1,377 acres)

Zoning: RR (Rural Reserve)

Existing Land Use: Ski Area

Conference Date: August 31, 2022

Report Issued: September 9, 2022

***DISCLAIMER: Pre-application conferences are conducted for purposes of providing applicants with a preliminary review of a project and timeline. Pre-application conferences are not based on a complete application, and are not a guarantee of final project approval.***

## List of Attendees

Note: Copies of the Pre-Application Conference Report will be emailed, instead of mailed, to participants who have provided their email address below.

Name	Title	Email address
Dave Scanlan	Applicant - Eaglecrest	<a href="mailto:Dave.Scanlan@juneau.org">Dave.Scanlan@juneau.org</a>
Alan Steffert	Applicant - Engineering	<a href="mailto:Alan.Steffert@juneau.org">Alan.Steffert@juneau.org</a>
Dan Jaeger	Fire Marshall	<a href="mailto:Dan.Jaeger@juneau.org">Dan.Jaeger@juneau.org</a>
Jennifer Shields	Planning	<a href="mailto:Jennifer.Shields@juneau.org">Jennifer.Shields@juneau.org</a>

## Conference Summary

The following is a list of issues, comments and proposed actions, and requested technical submittal items that were discussed at the pre-application conference.

### Project Overview

The applicants are proposing to add the following improvements at Eaglecrest Ski Area:

- Gondola with base station, upper station, and supporting structures
- “Summit House” at the gondola’s upper station, with a small snack bar, bathrooms, beer and wine bar, gift shop, and ski patrol station.
- Snow tubing park
- Access roads
- Mountain bike trails
- Picnic pavilion near Cropley Lake
- Weather enclosures at ski stations
- Fish creek bridge crossings

### Required Applications

- Development Permit Application (DPA): Required form in conjunction with all application types.
- City/State Project Review (CSP): Per 49.15.580 for CBJ capital improvement projects estimated to cost \$500,000 or more.
- Conditional Use Permit (CUP): The gondola would require a CUP under normal circumstances (TPU 6.270, Ariel Conveyance), but by the Assembly’s action they’ve approved of the gondola already.
- Conditional Use Permit (CUP): The Summit House would require a CUP (TPU 21.100, Lodge or Resort).
  - The Summit House was not included in materials provided to the Assembly during their discussions.
  - Assembly minutes do not include discussion of the Summit House.
  - The earliest documentation of the addition of a Summit House is on the first amendment to RFP E22-3331.
  - The Summit House has additional functions than housing gondola machinery.
  - While the project proponent has included the Summit House in public outreach and plans, those were not discussed or presented at the Assembly meetings where the gondola was discussed.
- Sand and Gravel Extraction (SGE): May be needed if development will use a quarry. Provide information on proposed extraction sites and uses, or exemption justification, based upon 49.65.200.

Note: The above-listed applications may be submitted concurrently for review by the Planning Commission. Please include a separate DPA for each application type.

### Planning Division

1. **Zoning** – The property is zoned RR (Rural Reserve). The following standards apply for properties within this Zoning District.
2. **Subdivision History** – N/A
3. **Setbacks** – Required setbacks are: Front and Rear 25’, Sides 15’. Provide a Site Plan of the area for the Upper Station/Summit House and include setback information as needed.
4. **Height** – Maximum 45’ height permitted for structures.
5. **Access** – The property has direct access from Fish Creek Road. MET

6. **Parking & Circulation** – Title 49 does not list a parking requirement for ski areas or any similar use. Parking requirements must, therefore, be based on observed and projected need. Provide a detailed analysis of parking in relation to projected need for the proposed development.
7. **Lot Coverage** – 10% permissible uses, 20% conditional uses. MET
8. **Vegetative Coverage** – Minimum 20% is required. MET
9. **Lighting** – All parking areas shall be suitably lighted with full cut-off design and not produce off-site glare. MET
10. **Noise** – N/A
11. **Flood** – The parcel is not within in a Special Flood Hazard Area.
12. **Hazard/Mass Wasting/Avalanche/Hillside Endorsement** – Using USGS contour data, the slope of the development area is ~18%. Per 49.70.200, future development of these areas would require a Hillside Endorsement at the time of Building Permit review.
13. **Wetlands** – Any future addition of fill material on the lot would require a permit from the Army Corps of Engineers.
14. **Habitat** – Check with the U.S. Fish and Wildlife on the presence of eagle nests in the area. The presence of eagle nests may impact future construction scheduling. Fish Creek is not considered anadromous on the subject parcel, or within 50 feet. It appears there is a 50 foot wide public access easement along Fish Creek. Consult with the Alaska Department of Fish and Game for requirements.
15. **Plat or Covenant Restrictions** – N/A
16. **Traffic** – Provide information on proposed traffic expectations, especially at peak times of winter and summer.
17. **Nonconforming situations** – N/A

#### **Building Division**

18. **Building** –
19. **Outstanding Permits** –BLD20220457, BLD20200764, BLD20180618, BLD20150006, BLD20140296, BLD20130741, BLD20110220, BLD20100391, BLD20100316, BLD2009-00313, BLD2008-00598, BLD2008-00589, BLD2006-00099, BLD2004-00776, BLD1997-00134,

#### **General Engineering/Public Works**

20. **Engineering** –
21. **Drainage** –
22. **Utilities** –

#### **Fire Marshal**

23. **Fire Items/Access** – The Summit House Building will require a Sprinkler System and Fire Alarm System.

#### **Other Applicable Agency Review**

24. ??? –

### **List of required applications**

Based upon the information submitted for pre-application review, the following list of applications must be submitted in order for the project to receive a thorough and speedy review.

1. Development Permit Application (DPA). *This form must accompany any land use application.*
2. City/State Project Review Application (CSP).
3. Conditional Use Permit Application (USE). If approved, additional building permits may be required.
4. Sand and Gravel Extraction Permit Application (SGE).

### **Additional Submittal Requirements**

Submittal of additional information, given the specifics of the development proposal and site, are listed below. These items will be required in order for the application to be determined Counter Complete.

1. A copy of this pre-application conference report.
2. Narrative.
3. Overall parcel site map(s) showing existing and proposed development features.
4. Detailed site plan showing area for the Upper Station/Summit House with setback information, and site plans for any other development areas with structures.
5. Parking data and analysis.
6. Traffic analysis.
7. Sand and gravel extraction information (or exemption justification).

### **Exceptions to Submittal Requirements**

Submittal requirements staff has determined not to be applicable or not required, given the specifics of the development proposal, are listed below. These items will not be required in order for the application to be reviewed.

1. N/A

### **Fee Estimates**

The preliminary plan review fees listed below can be found in the CBJ code section 49.85. Based upon the project plan submitted for pre-application review, staff has attempted to provide an accurate estimate for the permits and permit fees which will be triggered by your proposal.

1. City/State Project Review (CSP): \$1,600 for projects over \$2.5 million.
2. Conditional Use Permit (USE): \$500
3. Sand and Gravel Extraction Permit (SGE): Dependent upon class of proposed use, generally ranges between \$1,000 to \$1,600.
4. Public Notice Sign: \$150, with \$100 refundable if the sign is returned by the Monday after the Planning Commission meeting.

For informational handouts with submittal requirements for development applications, please visit our website at [www.juneau.org/cdd](http://www.juneau.org/cdd).

### **Submit your Completed Application**

You must submit your application(s) in person with payment made to:

City & Borough of Juneau, Permit Center  
230 South Franklin Street  
Fourth Floor Marine View Center  
Juneau, AK 99801

Phone: (907) 586-0715  
Web: [www.juneau.org/cdd](http://www.juneau.org/cdd)

**Attachments**

49.15.330 – Conditional Use Permits  
49.15.580 – City/State Project Reviews  
49.65.200 – Sand and Gravel Extraction  
49.70.200 – Hillside Endorsement

Development Permit Application (DPA)  
City/State Project Review Application (CSP)  
Conditional Use Permit Application (USE)  
Sand and Gravel Extraction Permit Application (SGE)