

JUNEAU SCHOOL DISTRICT DZANTIK' I HEENI MIDDLE SCHOOL ROOF REPAIR JUNEAU, ALASKA

JULY 2016
CBJ Project No. BE 17-082

ARCHITECT
JENSEN YORBA LOTT, INC
522 WEST 10TH STREET
JUNEAU, ALASKA 99801
(907) 586-1070
FAX (907) 586-3959

- GENERAL NOTES:
1. EXISTING ROOF 4:12 SLOPE, TYP, UON
2. EXISTING ROOFING, 3 TAB ASPHALT SHINGLES, TYP, UON
3. TAB DOWN REPLACED AND REPAIRED ASPHALT SHINGLES, TYP
4. PREPARE AND RE-PAINT EXISTING DOWNSPOUTS, TYP
5. ASSUME FOR BIDDING PURPOSES 2,500 SQFT OF ASPHALT SHINGLE REPLACEMENT
6. ASSUME FOR BIDDING PURPOSES 40 EPDM PATCHES

SHEET INDEX

A001	INDEX, ABBREVIATIONS, SYMBOLS
A101	CONTRACTOR STAGING PLAN
A201	EXISTING ROOF PLAN OVERALL
A201A	FALL PROTECTION ANCHOR ROOF PLAN
A202	RENOVATION ROOF PLAN WEST
A203	RENOVATION ROOF PLAN CENTER
A204	RENOVATION ROOF PLAN EAST
A301	EXTERIOR ELEVATIONS
A302	EXTERIOR ELEVATIONS
A303	EXTERIOR ELEVATIONS
A601	EXTERIOR DETAILS

ABBREVIATIONS

Z	ANGLE	EMER	EMERGENCY	LAM	LAMINATE	RH	ROBE HOOK	VEST	VESTIBULE
AC	ASPHALT CONCRETE	ENCL	ENCLOSURE	LAV	LAVATORY	RL	RAIN LEADER	VR	VAPOR RETARDER
ACM	ASBESTOS CONTAINING MATERIAL	EPDM	ETHYLENE PROPYLENE DIANE MONOMER	LB	POUND	RM	ROOM	RO	ROUGH OPENING
ACP	ACOUSTICAL CEILING PANEL	EPS	EXPANDED POLYSTYRENE	LT	LIGHT	RUB	RUBBER	WB	WEATHER BARRIER
ADJ	ADJUSTABLE	EQ	EQUAL	MIR	MIRROR	SASU	SELF ADHERING SHEET	WC	WATER CLOSET
AFF	ABOVE FINISH FLOOR	EQP	EQUIPMENT	MAX	MAXIMUM	WD	WOOD	WP	WATERPROOF
AIB	AIR INFILTRATION BARRIER	EX	EXISTING	MDO	MEDIUM DENSITY OVERLAID	WR	WASTE RECEPTACLE	WST	WAINSCOT
AL	ALUMINUM	EXT	EXTERIOR	MECH	MECHANICAL	SF	SQUARE FOOT	WT	WEIGHT
APPROX	APPROXIMATE	FA	FIRE ALARM	MEMB	MEMBRANE	SFRM	SPRAYED FIRE-RESISTIVE MATERIAL	WVF	WELDED WIRE FABRIC
ARCH	ARCHITECTURAL	FD	FLOOR DRAIN	MFR	MANUFACTURER	SHR	SHOWER		
ASB	ASBESTOS	FDN	FOUNDATION	MH	MANHOLE	SHTH	SHEATHING		
BD	BOARD	FEC	FIRE EXTINGUISHER CABINET	MIN	MINIMUM	SIM	SIMILAR		
BLDG	BUILDING	FF	FINISH FLOOR	MISC	MISCELLANEOUS	SND	SANITARY NAPKIN DISPENSER		
BLKG	BLOCKING	FHC	FIRE HOSE CABINET	MTD	MOUNTED	SNR	SANITARY NAPKIN RECEPTACLE		
BM	BEAM	FIN	FINISH	MTL	METAL	SPEC	SPECIFICATIONS		
BOT	BOTTOM	FLR	FLOOR	MUL	MULLION	SQ	SQUARE		
CAB	CABINET	FLR	FLOOR	NIC	NOT IN CONTRACT	SQFT	SQUARE FOOT		
CB	CATCH BASIN	FOC	FACE OF CONCRETE/CURB	NO OR #	NUMBER	SQYD	SQUARE YARD		
CEM	CEMENT	FOF	FACE OF FINISH	NOM	NOMINAL	SS	STAINLESS STEEL		
CG	CORNER GUARD	FOS	FACE OF STUD	NTS	NOT TO SCALE	STA	STATION		
CI	CAST IRON	FRP	(GLASS) FIBER REINFORCED PLASTIC	OA	OVERALL	STC	SOUND TRANSMISSION CLASS		
CLG	CEILING	FR	FIRE RETARDANT	OC	ON CENTER	STD	STANDARD		
COL	COLUMN	FT	FOOT OR FEET	OD	OUTSIDE DIAMETER	STL	STEEL		
CONC	CONCRETE	FTG	FOOTING	OFCI	OWNER FURNISHED CONTRACTOR INSTALLED	STOR	STORAGE		
CONT	CONTINUOUS	FURR	FURRING	OFOI	OWNER FURNISHED OWNER INSTALLED	STRUCT	STRUCTURAL		
CTR	CENTER	GA	GAUGE	OFD	OVERFLOW DRAIN	SUSP	SUSPENDED		
CTSK	COUNTERSUNK	GALV	GALVANIZED	OSB	ORIENTED STRAND BOARD	SY	SQUARE YARD		
DBL	DOUBLE	GB	GRAB BAR	PL	PLATE	TB	TOWEL BAR		
DEPT	DEPARTMENT	GL	GLASS	PLAM	PLASTIC LAMINATE	TC	TOP OF CURB		
DF	DRINKING FOUNTAIN	GWB	GYPSON WALL BOARD	PLAS	PLASTER	TEL	TELEPHONE		
DET	DETAIL	GYP	GYPSON	PC	PRE-CAST	TEMP	TEMPORARY		
DIA	DIAMETER	HB	HOSE BIBB	PF	PRE-FINISHED	T&G	TONGUE & GROOVE		
DIM	DIMENSION	HDWD	HARDWOOD	PWD	PLYWOOD	TOC	TOP OF CONCRETE		
DISP	DISPENSER	HM	HOLLOW METAL			TOD	TOP OF DECK		
DN	DOWN	HORIZ	HORIZONTAL			TPD	TOILET PAPER DISPENSER		
DR	DOOR	HR	HOUR			TRD	TREAD		
DS	DOWNSPOUT	HT	HEIGHT			TRD	PRESSURE TREATED		
DWG	DRAWING	HW	HOT WATER			TOW	TOP OF WALL		
DWR	DRAWER	ID	INSIDE DIAMETER			TYP	TYPICAL		
EA	EACH	INSUL	INSULATION						
EF	EXHAUST FAN	INT	INTERIOR						
EFIS	EXTERIOR INSULATION & FINISH SYSTEM	JAN	JANITOR						
EJ	EXPANSION JOINT	JT	JOINT						
EL	ELEVATION	LAB	LABORATORY						
ELEC	ELECTRICAL								
ELEV	ELEVATOR								

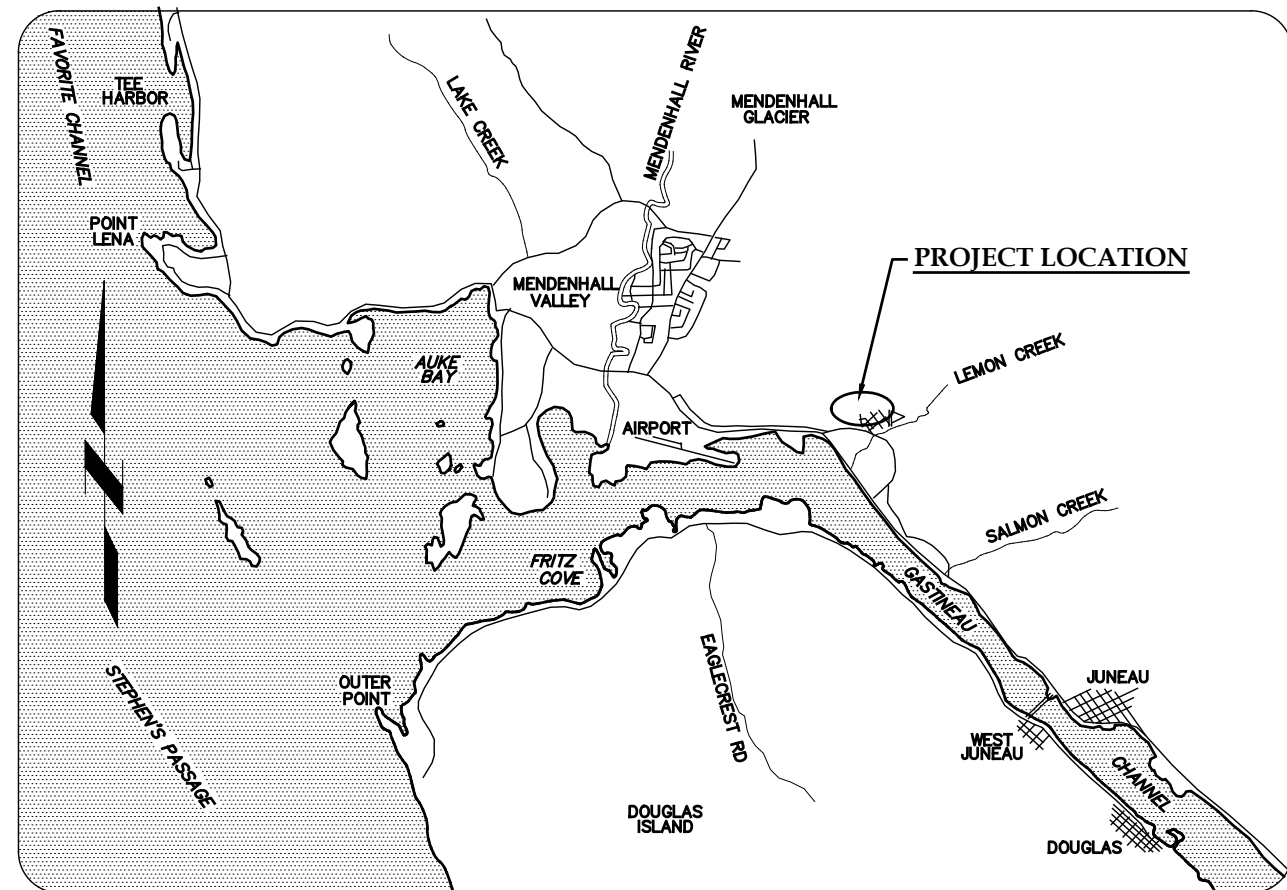

VICINITY MAP

NOT TO SCALE

SYMBOLS

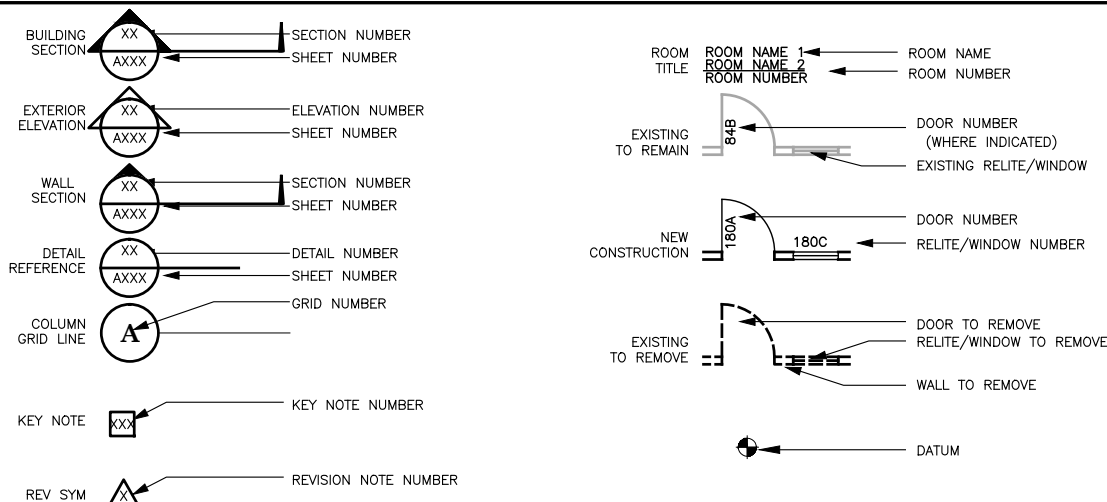

ADDENDUM

10/13/16
ADDENDUM #3

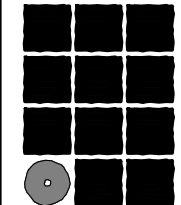

**Jensen
Yorba
Lott
Inc.**

522 West 10th Street
Juneau, Alaska 99801
phone 907-586-1070
fax 907-586-3959
jensenyorbalott.com
FILE: 16019

A001

G:_Projects\16019\CAD\CDArch\A201A.dwg, Layout1, 10/28/2016 10:31:53 AM, Dan, DWG To PDF.pc3, ANSI B (17.00 x 11.00 Inches), 1:2

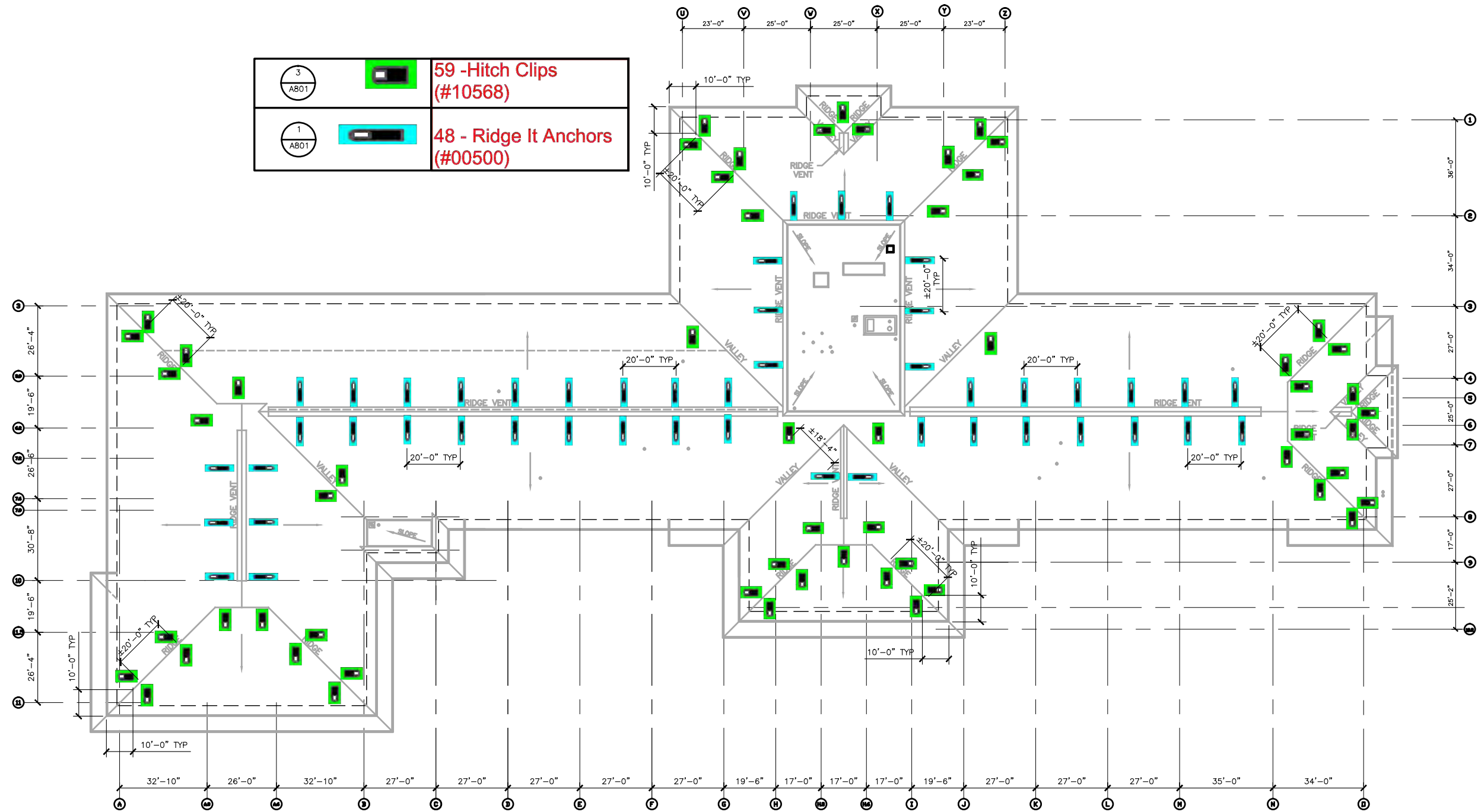

3 A801		59 - Hitch Clips (#10568)
1 A801		48 - Ridge It Anchors (#00500)

1 FALL PROTECTION ANCHOR ROOF PLAN

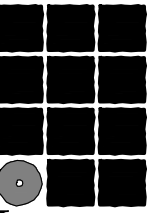

**Jensen
Yorba
Lott
Inc.**

522 West 10th Street
Juneau, Alaska 99801
phone 907-586-1070
fax 907-586-3959
jensenyorbaltott.com



**JUNEAU SCHOOL DISTRICT
DZANTIKI'HEENI MIDDLE SCHOOL
ROOF REPAIR
JUNEAU, ALASKA
CBJ Project No. BE 17-082**

ADDENDUM

- REVISIONS
- △ 10/13/16
ADDENDUM #3
 - △ .
 - △ .

SHEET TITLE
**FALL PROTECTION
ANCHOR
ROOF PLAN**

DATE: JULY 2016
FILE: 16019

A201A

G:\Projects\16019\CAD\CDArch\A801.dwg, Layout1, 10/28/2016 10:29:21 AM, Dan, DWG To PDF.pc3, ANSI B (17.00 x 11.00 Inches), 1:2

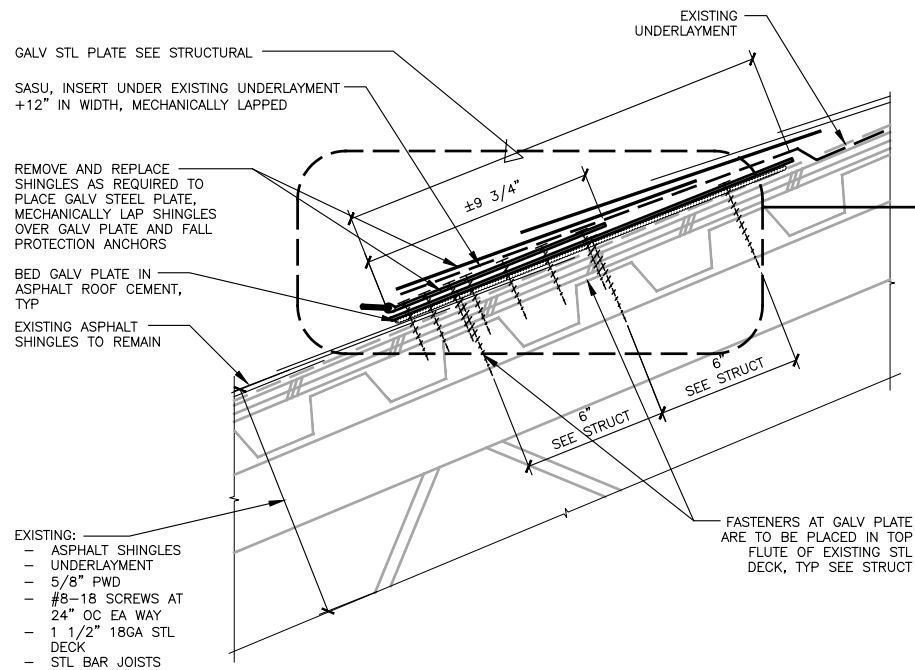

1 RIDGE-IT W/1 SINGLE D-RING ANCHOR POINT
16019/ X_A801-1 SCALE: 0 3" 6" 1'

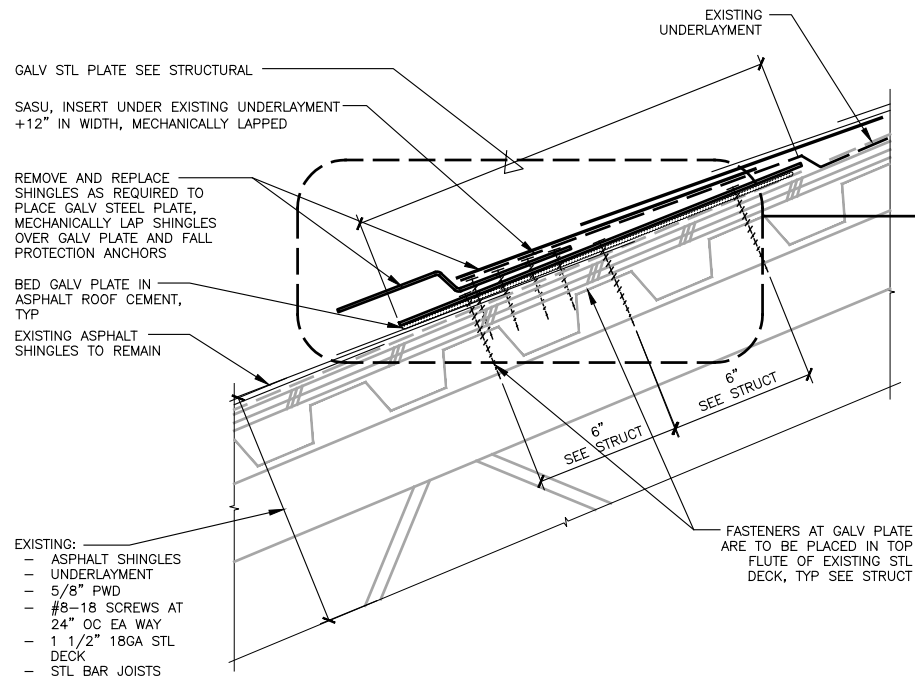

3 HITCHCLIP FALL PROTECTION ANCHOR
16019/ X_A801-3 SCALE: 0 3" 6" 1'

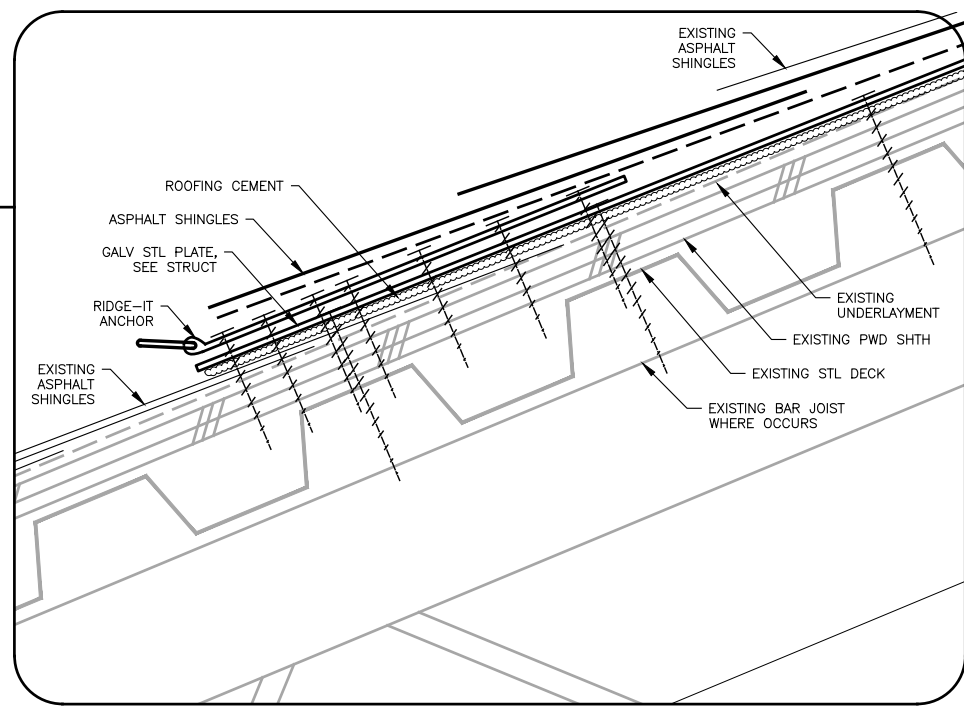

ENLARGED VIEW RIDGE-IT W/1 SINGLE D-RING ANCHOR

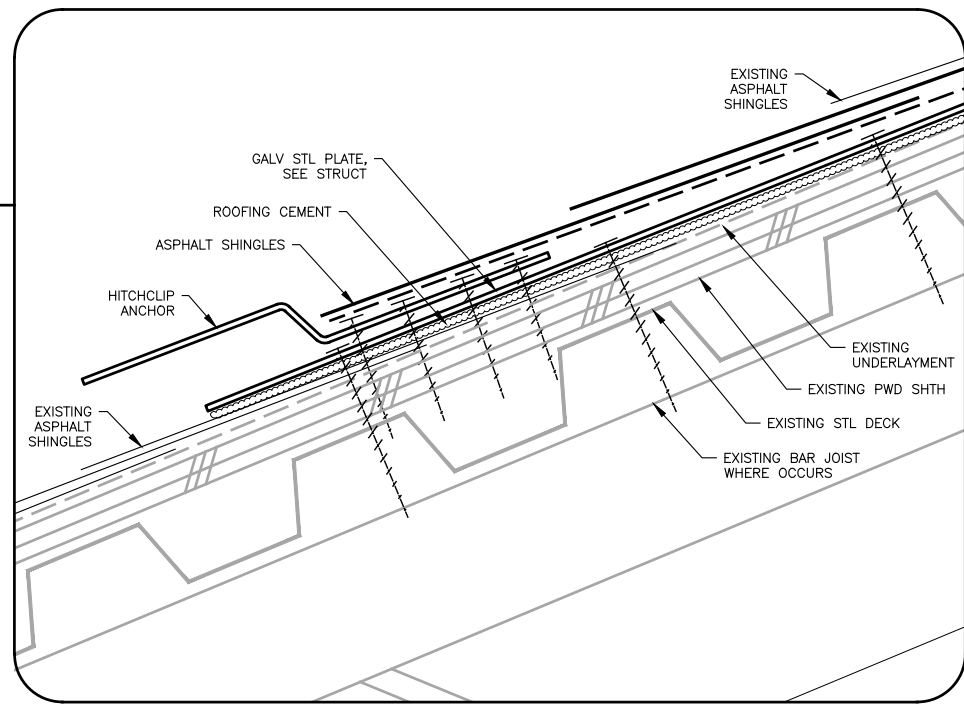

ENLARGED VIEW HITCHCLIP ANCHOR

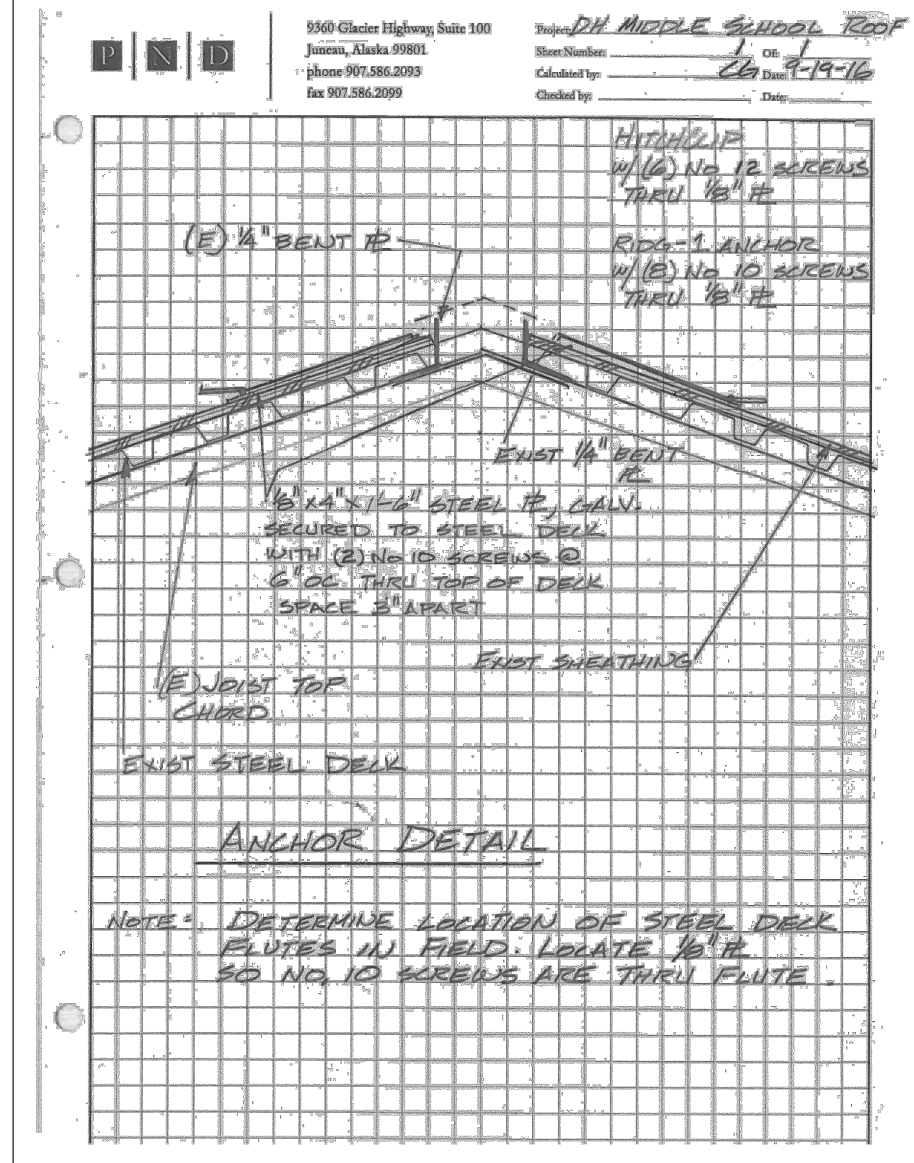

NOTE: DETERMINE LOCATION OF STEEL DECK FLUTES IN FIELD. LOCATE 1/2" PLATE SO NO. 10 SCREWS ARE THRU FLUTE

P N D

9560 Glacier Highway, Suite 100
Juneau, Alaska 99801
phone 907.586.2093
fax 907.586.2099

Project: DH MIDDLE SCHOOL ROOF
Sheet Number: _____
Calculation by: CL Date: 9-19-16
Checked by: _____ Date: _____

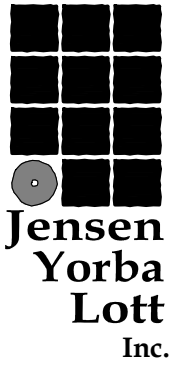

Jensen Yorba Lott Inc.
522 West 10th Street
Juneau, Alaska 99801
phone 907-586-1070
fax 907-586-3959
jensenyorbaltott.com

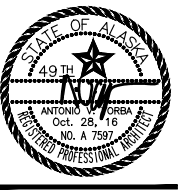

JUNEAU SCHOOL DISTRICT
DZANTIKI HEENI MIDDLE SCHOOL
ROOF REPAIR
JUNEAU, ALASKA
CJ Project No. BE 17-082

ADDENDUM

- REVISIONS
 ▲ 10/13/16 ADDENDUM #3
 ▲
 ▲

SHEET TITLE
 EXTERIOR
 DETAILS

DATE: JULY 2016
 FILE: 16019

▲ **A801**