

# **GOODWIN ROAD RECONSTRUCTION**

**Contract No. BE21-179**

File No. 2068



ENGINEERING DEPARTMENT

**SECTION 00005 - TABLE OF CONTENTS**

**DIVISION 0 - BIDDING AND CONTRACT REQUIREMENTS, CONTRACT FORMS, AND  
CONDITIONS OF THE CONTRACT**

**BIDDING and CONTRACT REQUIREMENTS No. of Pages**

00005	Table of Contents .....	2
00030	Notice Inviting Bids .....	2
00100	Instructions to Bidders .....	9
00300	Bid .....	2
00310	Bid Schedule .....	1
00320	Bid Bond .....	1
00360	Subcontractor Report.....	3
00370	Contractor’s Financial Responsibility .....	3

**CONTRACT FORMS**

00500	Agreement .....	6
00610	Performance Bond .....	2
00620	Payment Bond .....	2

**CONDITIONS OF THE CONTRACT**

00700	General Conditions .....	47
00800	Supplementary General Conditions .....	6
00830	Alaska Labor Standards, Reporting, and Prevailing Wage Rate Determination.....	1
	Appendix A- Pamphlet 600- Effective September 1, 2020.....	37
00853	Standard Details .....	1
	Special Provisions .....	44

**LIST OF DRAWINGS**

Sheet 1 of 15	COVER SHEET
Sheet 2 of 15	LEGEND, ABBREVIATIONS, AND GENERAL NOTES
Sheet 3 of 15	TYPICAL SECTION, TRAFFIC CONTROL AND PAVING SEQUENCING
Sheet 4 of 15	CORROSION PROTECTION DETAILS AND SUMMARY TABLES
Sheet 5 of 15	MISCELLANEOUS DETAILS
Sheet 6 of 15	MISCELLANEOUS DETAILS
Sheet 7 of 15	HORIZONTAL AND VERTICAL CONTROL CURB AND GUTTER LAYOUT AND GRADES BLUEBERRY HILLS RD TO STA “G” 12+60
Sheet 8 of 15	HORIZONTAL AND VERTICAL CONTROL CURB AND GUTTER LAYOUT AND GRADES

**SECTION 00005 - TABLE OF CONTENTS**

	STA "G" 12+60 TO STA "G" 15+10
Sheet 9 of 15	HORIZONTAL AND VERTICAL CONTROL CURB AND GUTTER LAYOUT AND GRADES STA "G" 15+10 TO EOP
Sheet 10 of 15	PLAN – GOODWIN ROAD BLUEBERRY HILLS RD TO STA "G" 12+60
Sheet 11 of 15	PLAN – GOODWIN ROAD STA "G" 12+60 TO STA "G" 15+10
Sheet 12 of 15	PLAN – GOODWIN ROAD STA "G" 15+10 TO EOP
Sheet 13 of 15	PROFILE – GOODWIN ROAD BLUEBERRY HILLS RD TO STA "G" 12+60
Sheet 14 of 15	PROFILE – GOODWIN ROAD STA "G" 12+60 TO EOP

**END OF SECTION**

## SECTION 00030 NOTICE INVITING BIDS

**OBTAINING CONTRACT DOCUMENTS.** The Contract Documents are entitled:

**Goodwin Road Reconstruction  
Contract No. BE21-179**

The Contract Documents may be downloaded for free at the CBJ Engineering Department webpage at: [www.juneau.org/engineering](http://www.juneau.org/engineering)

**PRE-BID CONFERENCE.** Prospective Bidders are encouraged to attend a pre-Bid conference to discuss the proposed WORK, which will be conducted by the OWNER, at 10:00 a.m. on January 6, 2021. The object of the conference is to acquaint Bidders with the project and bid documents. Conference call capability will be available for the Pre-Bid meeting. Proposers intending to participate via conference call shall notify Paula Osborn in the CBJ Engineering Contracts Division, at (907) 586-0888, or [Contract@Juneau.Org](mailto:Contract@Juneau.Org) by 4:30 p.m., January 5, 2021.

**DESCRIPTION OF WORK.** The WORK covered in the Contract Documents generally includes: Reconstruction of Goodwin Road from Blueberry Hills Road. WORK will include replacement of the water main and services, replacement of sanitary sewer force main and a segment of gravity sewer main, replacement of three sanitary sewer services, installation of two new sanitary sewer services, installation of sewer cleanouts, and installation of a new storm drain system. WORK will also include replacement of the roadway subbase to a depth of 18-inches, the installation of a new curb and gutter, and resurfacing with asphalt cement pavement.

**COMPLETION OF WORK.** The WORK must be completed by September 1, 2021 or 90 days after start of WORK.

**DEADLINE FOR BIDDER QUESTIONS: January 8, 2021**

**DEADLINE FOR BIDS:** Sealed bids must be received by the Purchasing Division **prior to 2:00 p.m., Alaska Time on January 13, 2021,** or such later time as may be announced by addendum at any time prior to the deadline. Bids will be time and date stamped by the Purchasing Division, which will establish the official time of receipt of bids. Bids will be opened immediately thereafter in the Assembly Chambers of the Municipal Building, 155 S. Seward Street, unless otherwise specified. Bidders may attend this bid opening on the conference call line 907-713-2140, with participant code 258358.

Bid documents delivered in person or by **courier** service must be delivered to:

Bid documents delivered by **U.S. Postal Service** must be mailed to:

**PHYSICAL LOCATION:**

City and Borough of Juneau, Purchasing Division  
105 Municipal Way, Room 300  
Juneau, AK 99801

**MAILING ADDRESS:**

City and Borough of Juneau, Purchasing Division  
155 South Seward Street  
Juneau, AK 99801

**\* A face covering must be worn in the  
105 Municipal Way building per the  
CBJ Emergency Ordinance No. 2020-45**



**SECTION 00030 NOTICE INVITING BIDS**

**OWNER'S RIGHTS RESERVED.** The OWNER reserves the right to reject any or all Bids, to waive any informality in a Bid, and to make award to the lowest responsive, responsible Bidder as it may best serve the interests of the OWNER.

**OWNER: City and Borough of Juneau**

By:  \_\_\_\_\_ Date 12/23/2020  
Greg Smith, Contract Administrator

**END OF SECTION**

## SECTION 00100 - INSTRUCTIONS TO BIDDERS

**1.0 DEFINED TERMS.** Terms used in these Instructions to Bidders and the Notice Inviting Bids, which are defined in the General Conditions, have the meanings assigned to them in the General Conditions. The term "Bidder" means one who submits a Bid directly to the OWNER, as distinct from a sub-bidder, who submits a Bid to a Bidder.

### **2.0 INTERPRETATIONS AND ADDENDA.**

- A. **INTERPRETATIONS.** All questions about the meaning or intent of the Contract Documents are to be directed to the Engineering Contracts Administrator. Interpretations or clarifications considered necessary by the Engineering Contracts Administrator in response to such questions will be issued by Addendum, mailed, faxed, or delivered to all parties recorded by the Engineering Contracts Administrator, or OWNER, as having received the Contract Documents. Questions received less than seven Days prior to the Deadline for Bids may not be answered. Only questions answered by formal written Addendum will be binding. Oral and other interpretations or clarifications will be without legal effect.
- B. **ADDENDA.** Addenda may be issued to modify the Contract Documents as deemed advisable by the OWNER. Addenda may be faxed or, if addendum format warrants, addenda may be posted to the CBJ Engineering Department website. In any event, notification of addendum issuance will be faxed to planholders. Hard copies are available upon request. The OWNER will make all reasonable attempts to ensure that all planholders receive notification of Addenda, however, it is strongly recommended by the OWNER that bidders independently confirm the contents, number, and dates of each Addendum prior to submitting a Bid.

**3.0 FAIR COMPETITION.** More than one Bid from an individual, firm, partnership, corporation, or association under the same or different names will not be considered. If the OWNER believes that any Bidder is interested in more than one Bid for the WORK contemplated, all Bids in which such Bidder is interested will be rejected. If the OWNER believes that collusion exists among the Bidders, all Bids will be rejected.

**4.0 RESPONSIBILITY OF BIDDERS.** Only responsive Bids from responsible Bidders will be considered. A Bid submitted by a Bidder determined to be not responsible may be rejected. The OWNER may find a bidder to be not responsible for any one of the following reasons, but is not limited in its responsibility analysis to the following factors:

- A. Evidence of bid rigging or collusion;
- B. Fraud or dishonesty in the performance of previous contracts;
- C. Record of integrity;
- D. More than one bid for the same work from an individual, firm, or corporation under the same or different name;
- E. Unsatisfactory performance on previous or current contracts;
- F. Failure to pay, or satisfactorily settle, all bills due for labor and material on previous contracts;

## SECTION 00100 - INSTRUCTIONS TO BIDDERS

- G. Uncompleted work that, in the judgment of the OWNER, might hinder or prevent the bidder's prompt completion of additional work, if awarded;
- H. Failure to reimburse the OWNER for monies owed on any previous contracts;
- I. Default under previous contracts;
- J. Failure to comply with any qualification requirements of the OWNER; special standards for responsibility, if applicable, will be specified. These special standards establish minimum standards or experience required for a responsible Bidder on a specific contract;
- K. Engaging in any activity that constitutes a cause for debarment or suspension under the CBJ Procurement Code 53.50 or submitting a bid during a period of debarment;
- L. Lack of skill, ability, financial resources, or equipment required to perform the contract; or
- M. Lack of legal capacity to contract.
- N. Bidders must be registered as required by law and in good standing for all amounts owed to the OWNER per Paragraph 21.0 of this Section.
- O. Failure to submit all completed documents as required and specified on the Bid Form, Section 00300.

Nothing contained in this section deprives the OWNER of its discretion in determining the lowest responsible bidder. Before a Bid is considered for award, a Bidder may be requested to submit information documenting its ability and competency to perform the WORK, according to general standards of responsibility and any special standards which may apply. It is Bidder's responsibility to submit sufficient, relevant, and adequate information. OWNER will make its determination of responsibility and has no obligation to request clarification or supplementary information.

**5.0 NON-RESPONSIVE BIDS.** Only responsive Bids will be considered. Bids may be considered non-responsive and may be rejected. Some of the reasons a Bid may be rejected for being non-responsive are:

- A. If a Bid is received by the CBJ Purchasing Division after the Deadline for Bids.
- B. If the Bid is on a form other than that furnished by the OWNER, or legible copies thereof; or if the form is altered or any part thereof is detached; or if the Bid is improperly signed.
- C. If there are unauthorized additions, conditional or alternate Bids, or irregularities of any kind which may tend to make the bid incomplete, indefinite, ambiguous as to its meaning, or in conflict with the OWNER's Bid document.
- D. If the Bidder adds any unauthorized conditions, limitations, or provisions reserving the right to accept or reject any award, or to enter into a contract pursuant to an award. This does not exclude a Bid limiting the maximum gross amount of awards acceptable to any one Bidder at any one Bid opening, provided that any selection of awards will be made by the OWNER.
- E. If the Bid does not contain a Unit Price for each pay item listed, except in the case of



## **SECTION 00100 - INSTRUCTIONS TO BIDDERS**

authorized alternate pay items.

- F. If the Bidder has not acknowledged receipt of each Addendum.
- G. If the Bidder fails to furnish an acceptable Bid guaranty with the Bid.
- H. If any of the Unit Prices Bid are excessively unbalanced (either above or below the amount of a reasonable Bid) to the potential detriment of the OWNER.
- I. If a Bid modification does not conform to Article 15.0 of this Section.

**6.0 BIDDER'S EXAMINATION OF CONTRACT DOCUMENTS AND SITE.** It is the responsibility of each Bidder before submitting a Bid:

- A. To examine thoroughly the Contract Documents, and other related data identified in the Bidding documents (including "technical data" referred to below):
  - 1. To visit the site to become familiar with and to satisfy the Bidder as to the general and local conditions that may affect cost, progress, or performance, of the WORK,
  - 2. To consider federal, state and local laws and regulations that may affect cost, progress, or performance of the WORK,
  - 3. To study and carefully correlate the Bidder's observations with the Contract Documents, and other related data; and
  - 4. To notify the ENGINEER of all conflicts, errors, or discrepancies in or between the Contract Documents and such other related data.

**7.0 REFERENCE IS MADE TO THE SUPPLEMENTARY GENERAL CONDITIONS FOR IDENTIFICATION OF:**

- A. Those reports of explorations and tests of subsurface conditions at the site which have been utilized by the Engineer of Record in the preparation of the Contract Documents. The Bidder may rely upon the accuracy of the technical data contained in such reports, however, the interpretation of such technical data, including any interpolation or extrapolation thereof, together with non-technical data, interpretations, and opinions contained therein or the completeness thereof is the responsibility of the Bidder.
- B. Those Drawings of physical conditions in or relating to existing surface and subsurface conditions (except underground utilities) which are at or contiguous to the site have been utilized by the Engineer of Record in the preparation of the Contract Documents. The Bidder may rely upon the accuracy of the technical data contained in such Drawings, however, the interpretation of such technical data, including any interpolation or extrapolation thereof, together with nontechnical data, interpretations, and opinions contained in such Drawings or the completeness thereof is the responsibility of the Bidder.
- C. Copies of such reports and Drawings will be made available by the OWNER to any Bidder on request if said reports and Drawings are not bound herein. Those reports and Drawings are not part of the Contract Documents, but the technical data contained therein upon which the Bidder is entitled to rely, as provided in Paragraph SGC-4.2 of the Supplementary General Conditions, are incorporated herein by reference.

## SECTION 00100 - INSTRUCTIONS TO BIDDERS

- D. Information and data reflected in the Contract Documents with respect to underground utilities at or contiguous to the site is based upon information and data furnished to the OWNER and the Engineer of Record by the owners of such underground utilities or others, and the OWNER does not assume responsibility for the accuracy or completeness thereof unless it is expressly provided otherwise in the Supplementary General Conditions, or in Section 01530 - Protection and Restoration of Existing Facilities of the General Requirements.
- E. Provisions concerning responsibilities for the adequacy of data furnished to prospective Bidders on subsurface conditions, underground utilities and other physical conditions, and possible changes in the Contract Documents due to differing conditions appear in Paragraphs 4.2, 4.3, and 4.4 of the General Conditions.
- F. Before submitting a Bid, each Bidder will, at Bidder's own expense, make or obtain any additional examinations, investigations, explorations, tests, and studies and obtain any additional information and data which pertain to the physical conditions (surface, subsurface, and underground utilities) at or contiguous to the site or otherwise which may affect cost, progress, or performance of the WORK and which the Bidder deems necessary to determine its Bid for performing the WORK in accordance with the time, price, and other terms and conditions of the Contract Documents.
- G. On request in advance, the OWNER will provide each Bidder access to the site to conduct such explorations and tests as each Bidder deems necessary for submission of a Bid. Bidder shall fill all holes and shall clean up and restore the site to its former condition upon completion of such explorations.
- H. The lands upon which the WORK is to be performed, rights-of-way and easements for access thereto and other lands designated for use by the CONTRACTOR in performing the WORK are identified in the Contract Documents. All additional lands and access thereto required for temporary construction facilities or storage of materials and equipment are to be provided by the CONTRACTOR. Easements for permanent structures or permanent changes in existing structures are to be obtained and paid for by the OWNER unless otherwise provided in the Contract Documents.
- I. The submission of a Bid will constitute an incontrovertible representation by the Bidder that the Bidder has complied with every requirement of Article 6.0, "Bidder's Examination of Contract Documents and Site" herein, that without exception the Bid is premised upon performing the WORK required by the Contract Documents and such means, methods, techniques, sequences, or procedures of construction as may be indicated in or required by the Contract Documents, and that the Contract Documents are sufficient in scope and detail to indicate and convey understanding of all terms and conditions for performance of the WORK.

### 8.0 BID FORM.

- A. The Bid shall be made on the Bid Schedule(s) bound herein, or on the yellow Bid packet provided, or on legible and complete copies thereof, and shall contain the following: Sections 00300, 00310, the required Bid Security, and any other documents required in Section 00300 – Bid.
- B. All blanks on the Bid Form and Bid Schedule must be completed in ink or typed.

## SECTION 00100 - INSTRUCTIONS TO BIDDERS

- C. Bids by corporations must be executed in the corporate name by the president, a vice-president (or other corporate officer). The corporate address and state of incorporation must appear below the signature.
- D. Bids by partnerships must be executed in the partnership name and be signed by a managing partner, and the official address of the partnership must appear below the signature.
- E. The Bidder's Bid must be signed. All names must be printed or typed below the signature.
- F. The Bid shall contain an acknowledgment of receipt of all Addenda, the numbers of which shall be filled in on the Bid form. Failure to acknowledge Addenda may render Bid non-responsive and may cause its rejection.
- G. The address to which communications regarding the Bid are to be directed must be shown.

**9.0 QUANTITIES OF WORK.** The quantities of WORK, or material, stated in Unit Price items of the Bid are supplied only to give an indication of the general scope of the WORK; the OWNER does not expressly or by implication agree that the actual amount of WORK, or material, will correspond therewith, and reserves the right after award to increase or decrease the amount of any Unit Price item of the WORK by an amount up to and including 25 percent of any Bid item, without a change in the Unit Price, and shall include the right to delete any Bid item in its entirety, or to add additional Bid items up to and including an aggregate total amount not to exceed 25 percent of the Contract Price (see Section 00700 - General Conditions, Article 10 Changes In the WORK).

**10.0 SUBSTITUTE OR "OR-EQUAL" ITEMS.** Substitution requests are not accepted during the bidding process. The procedure for the submittal of substitute or "or-equal" products is specified in Section 01300 – Contractor Submittals.

**11.0 SUBMISSION OF BIDS.** The Bid shall be delivered by the time and to the place stipulated in Section 00030 - Notice Inviting Bids. It is the Bidder's sole responsibility to see that its Bid is received in proper time. Oral, telegraphic, emailed, or faxed Bids will not be considered. The envelope enclosing the sealed Bids shall be plainly marked in the upper left-hand corner with the name and address of the Bidder and shall also include the label included in Section 00030 – Notice Inviting Bids. The Bid Security shall be enclosed in the same envelope with the Bid

**12.0 BID SECURITY, BONDS, AND INSURANCE.** Each Bid shall be accompanied by a certified, or cashier's check, or approved Bid Bond in an amount of at least 5 percent of the total Bid price. The "total Bid price" is the amount of the Base Bid, plus the amount of alternate Bids, if any, which total to the maximum amount for which the CONTRACT could be awarded. Said check or Bond shall be made payable to the OWNER and shall be given as a guarantee that the Bidder, if offered the WORK, will enter into an Agreement with the OWNER, and will furnish the necessary insurance certificates, Payment Bond, and Performance Bond; each of said Bonds, if required, and insurance amounts shall be as stated in the Supplementary General Conditions. In case of refusal or failure to enter into said Agreement, the check or Bid Bond, as the case may be, may be forfeited to the OWNER. If the Bidder elects to furnish a Bid Bond as its Bid security, the Bidder shall use the Bid Bond form bound herein, or one conforming substantially to it in form. Bid Bonds must be accompanied by a legible Power of Attorney.

## SECTION 00100 - INSTRUCTIONS TO BIDDERS

**13.0 RETURN OF BID SECURITY.** The OWNER will return all Bid security checks (certified or cashier's) accompanying such of the Bids as are not considered in making the award. All other Bid securities will be held until the Agreement has been executed. Following execution of the Agreement, all other Bid security checks will be returned to the respective Bidders whose Bids they accompanied and Bid security bonds will be appropriately discarded.

**14.0 DISCREPANCIES IN BIDS.** In the event there is more than one Pay Item in a Bid Schedule, the Bidder shall furnish a price for all Pay Items in the schedule, and failure to do so may render the Bid non-responsive and cause its rejection. In the event there are Unit Price Pay Items in a Bid Schedule and the "amount" indicated for a Unit Price Bid Item does not equal the product of the Unit Price and quantity, the Unit Price shall govern and the amount will be corrected accordingly, and the Bidder shall be bound by said correction. In the event there is more than one Pay Item in a Bid Schedule and the total indicated for the schedule does not agree with the sum of the prices Bid on the individual items, the prices Bid on the individual items shall govern and the total for the schedule will be corrected accordingly, and the Bidder shall be bound by said correction.

### **15.0 BID MODIFICATIONS AND UNAUTHORIZED ALTERNATIVE BIDS.**

- A. Any bidder may deliver a modification to a bid in person, by mail or fax (907-586-4561), provided that such modification is received by the Purchasing Division no later than the deadline for bids. Modifications will be time and date stamped by the Purchasing Division, which will establish the official time of receipt of the modification. The modification must not reveal the bid price but should be in the form of an addition or subtraction or other modification so that the final prices will not be known until the sealed bid is opened.

The Bid modifications shall be provided on the **Bid Modification Form** located at the end of this Section. Submittal of any other form by the vendor may deem the modification unacceptable by the OWNER. **A mail or fax modification should not reveal the Bid price but should provide the addition or subtraction or other modification so that the final prices will not be known by the City and Borough until the sealed Bid is opened.** Submitted Modification forms shall include the modification to the unit price or lump sum amount of each pay item modified.

**FAX DISCLAIMER:** It is the responsibility of the bidder to submit modifications in a timely manner. Bidders' use of a fax machine to modify their bid shall be at bidders' sole risk. The Purchasing Division will attempt to keep the fax machine in good working order but will not be responsible for bid modifications that are late due to mechanical failure, a busy fax machine, or any other cause arising from bidder's use of a fax machine, even if bidder submits a transmission report or provides other confirmation indicating that the bidder transmitted a bid modification prior to the deadline. The City will not be responsible for its failure to receive the modification whether such failure is caused by equipment or human error, or otherwise. Bidders are therefore strongly encouraged to confirm receipt of their bid modification with the Purchasing Division (907-586-5258) prior to deadline.

- B. Conditioned bids, limitations, or provisos attached to the Bid or bid modification will render it unauthorized and cause its rejection as being non-responsive. The completed Bid forms shall be without interlineations, alterations, or erasures in the printed text. All changes shall be initialed by the person signing the Bid. Alternative Bids will not be considered unless called for.

## SECTION 00100 - INSTRUCTIONS TO BIDDERS

**16.0 WITHDRAWAL OF BID.** Prior to the Deadline for Bids, the Bid may be withdrawn by the Bidder by means of a written request, signed by the Bidder or its properly authorized representative. Such written request must be delivered to the place stipulated in the Notice Inviting Bids for receipt of Bids.

### **17.0 AWARD OF CONTRACT.**

- A. Award of a contract, if it is awarded, will be on the basis of materials and equipment described in the Drawings or specified in the Technical Specifications and will be made to the lowest responsive, responsible Bidder whose Bid complies with all the requirements prescribed. Unless otherwise specified, any such award will be made within the period stated in the Notice Inviting Bids that the Bids are to remain open. Unless otherwise indicated, a single award will be made for all the Bid items in an individual Bid Schedule.
- B. If the OWNER has elected to advertise this Project with a Base Bid and Alternates, the OWNER may elect to award the contract for the Base Bid, or the Base Bid in combination with one or more Alternates selected by the OWNER. In either case, award shall be made to the responsive, responsible bidder offering the lowest total Bid for the WORK to be awarded.

### **18.0 EXECUTION OF AGREEMENT.**

- A. All Bids of value greater than \$1,000,000 must be approved by the CBJ Assembly. After the CBJ Assembly has approved the award and after the Bid protest period, the OWNER will issue a Notice of Intent to Award to the approved Bidder. The Bidder to whom award is made shall execute a written Agreement with the OWNER on the Agreement form, Section 00500, collect insurance, and shall furnish all certificates and Bonds required by the Contract Documents within 10 Days (calendar) from the date of the Notice of Intent to Award letter.
- B. Failure or refusal to enter into the Agreement as herein provided or to conform to any of the stipulated requirements in connection therewith shall be just cause for annulment of the award and forfeiture of the Bid security. If the lowest responsive, responsible Bidder refuses or fails to execute the Agreement, the OWNER may award the contract to the second lowest responsive, responsible Bidder. If the second lowest responsive, responsible Bidder refuses or fails to execute the Agreement, the OWNER may award the contract to the third lowest responsive, responsible Bidder. On the failure or refusal of such second or third lowest Bidder to execute the Agreement, each such Bidder's Bid securities shall be likewise forfeited to the OWNER.

**19.0 LIQUIDATED DAMAGES.** Provisions for liquidated damages if any, are set forth in Section 00500 - Agreement.

### **20.0 FILING A PROTEST.**

- A. A Bidder may protest the proposed award of a competitive sealed Bid by the City and Borough of Juneau. The protest shall be executed in accordance with CBJ Ordinance 53.50.062 PROTESTS and CBJ Ordinance 53.50.080 ADMINISTRATION OF PROTEST. The entire text of the CBJ Purchasing Ordinance can be accessed at the CBJ website, <http://www.juneau.org/law/code/code.php>, or call the CBJ Purchasing Division at

## SECTION 00100 - INSTRUCTIONS TO BIDDERS

(907) 586-5258 for a copy of the ordinance.

B. Late protests shall not be considered by the CBJ Purchasing Officer.

### 21.0 **CONTRACTOR'S GOOD STANDING WITH CBJ FINANCE DEPARTMENT:**

Contractors must be in good standing with the CBJ prior to award, and prior to any contract renewals, and in any event no later than *seven business days* following notification by the CBJ of intent to award. **Good standing** means: all amounts owed to the CBJ are current and the Contractor is not delinquent with respect to any taxes, fees, assessment, or other monies due and owed the CBJ, or a Confession of Judgment has been executed and the Contractor is in compliance with the terms of any stipulation associated with the Confession of Judgment, including being current as to any installment payments due; and Contractor is current in all CBJ reporting obligations (such as sales tax registration and reporting and business personal property declarations). Failure to meet these requirements may be cause for rejection of your bid. To determine if your business is in good standing, or for further information, contact the CBJ Finance Department's Sales Tax Division at (907) 586-5265 for sales tax issues, Assessor's Office at (907)586-0930 for business personal property issues, or Collections Division at (907) 586-5268 for all other accounts.

**22.0 PERMITS AND LICENSES.** The CONTRACTOR is responsible for all WORK associated with meeting any local, state, and/or federal permit and licensing requirements.

**SECTION 00100 - INSTRUCTIONS TO BIDDERS**

CITY AND BOROUGH OF JUNEAU  
PURCHASING DIVISION  
FAX NO. 907-586-4561

**BID MODIFICATION FORM**

Modification Number: \_\_\_\_\_

Modification Page \_\_\_\_ of \_\_\_\_

Note: All modifications shall be made to the original bid amount(s). If more than one Modification form is submitted by any one bidder, changes from all Modification forms submitted will be combined and applied to the original bid. Changes to the modified Bid amounts will be calculated by the OWNER. Bidder may use multiple modification pages if required.

<b>PAY ITEM NO.</b>	<b>PAY ITEM DESCRIPTION</b>	<b>MODIFICATIONS TO UNIT PRICE OR LUMP SUM (indicate +/-)</b>

**Base Bid Total Increase or Decrease: \$ \_\_\_\_\_**

\_\_\_\_\_  
**Name of Bidding Firm**

\_\_\_\_\_  
**Responsible Party Signature**

\_\_\_\_\_  
**Printed Name (must be an authorized signatory for Bidding Firm)**

**END OF SECTION**

**SECTION 00300 - BID**

**BID TO: THE CITY AND BOROUGH OF JUNEAU**

1. The undersigned Bidder proposes and agrees, if this Bid is accepted, to enter into an Agreement with the OWNER on the form included in the Contract Documents (as defined in Article 7 of Section 00500 - Agreement) to perform the WORK as specified or indicated in said Contract Documents entitled

**Goodwin Road Reconstruction  
Contract No. BE21-179**

2. Bidder accepts all of the terms and conditions of the Contract Documents, including without limitation those in the "Notice Inviting Bids" and "Instructions to Bidders," dealing with the disposition of the Bid Security.
3. This Bid will remain open for the period stated in the "Notice Inviting Bids" unless otherwise required by law. Bidder will enter into an Agreement within the time and in the manner required in the "Notice Inviting Bids" and the "Instructions to Bidders," and will furnish insurance certificates, Payment Bond, Performance Bond, and any other documents as may be required by the Contract Documents.
4. Bidder has familiarized itself with the nature and extent of the Contract Documents, WORK, site, locality where the WORK is to be performed, the legal requirements (federal, state and local laws, ordinances, rules, and regulations), and the conditions affecting cost, progress or performance of the WORK and has made such independent investigations as Bidder deems necessary.
5. This Bid is genuine and not made in the interest of or on behalf of any undisclosed person, firm or corporation and is not submitted in conformity with any agreement or rules of any group, association, organization or corporation; Bidder has not directly or indirectly induced or solicited any other Bidder to submit a false or sham Bid; Bidder has not solicited or induced any person, firm or corporation to refrain from bidding; and Bidder has not sought by collusion to obtain for itself any advantage over any other Bidder or over OWNER.
6. To all the foregoing, and including all Bid Schedule and information required of Bidder contained in this Bid Form, said Bidder further agrees to complete the WORK required under the Contract Documents within the Contract Time stipulated in said Contract Documents, and to accept in full payment therefore the Contract Price based on the total bid price(s) named in the aforementioned Bid Schedule.
7. Bidder has examined copies of all the Contract Documents including the following Addenda (receipt of all of which is hereby acknowledged by the Undersigned):

Addenda No.	Date Issued	Addenda No.	Date Issued

**Give number and date of each Addenda above. Failure to acknowledge receipt of all Addenda may cause the Bid to be non-responsive and may cause its rejection.**



**SECTION 00300 - BID**

8. The Bidder has read this Bid and agrees to the conditions as stated herein by signing its signature in the space provided below.

Dated: _____	Bidder: _____ (Company Name)
Alaska CONTRACTOR's Business License No: _____	By: _____ (Signature)
Alaska CONTRACTOR's License No: _____	Printed Name: _____ Title: _____
Telephone No: _____	Address: _____ (Street or P.O. Box)
Fax No: _____	_____ (City, State, Zip)
E-mail: _____	

9. **TO BE CONSIDERED, ALL BIDDERS MUST COMPLETE AND INCLUDE THE FOLLOWING AT THE TIME OF THE DEADLINE FOR BIDS. MISSING DOCUMENTS WILL DEEM THIS BID NON-RESPONSIVE:**

- Bid, Section 00300 (includes Addenda receipt statement)
- Completed Bid Schedule, Section 00310
- Bid Security (Bid Bond, Section 00320, or by a certified or cashier's check as stipulated in the Notice Inviting Bids, Section 00030)
- **Contractor Financial Responsibility, Section 00370**

10. The apparent low Bidder is required to complete and submit the following documents by 4:30 p.m. on the **fifth business day** following the date of the Posting Notice.

- Subcontractor Report, Section 00360

The apparent low Bidder who fails to submit the completed Subcontractor Report within the time specified in Section 00360 – Subcontractor Report, may be found to be not a responsible Bidder and may be required to forfeit the Bid security. The OWNER may then consider the next lowest Bidder for award of the contract.

11. The successful Bidder will be required to submit, **within ten Days (calendar)** after the date of the “Notice of Intent to Award” letter, the following executed documents:

- Agreement Forms, Section 00500
- Performance Bond, Section 00610
- Payment Bond, Section 00620
- Certificates of Insurance, (CONTRACTOR) Section 00700 and Section 00800

**END OF SECTION**

**SECTION 00310 - BID SCHEDULE**

PAY ITEM NO.	PAY ITEM DESCRIPTION	PAY UNIT	APPROX. QUANTITY	UNIT PRICE		AMOUNT	
				DOLLARS	CENTS	DOLLARS	CENTS
1505.1	Mobilization	Lump Sum	All Req'd	LUMP	SUM		
1570.1	Erosion and Sediment Control	Lump Sum	All Req'd	LUMP	SUM		
2201.1	Hand Clearing	Lump Sum	All Req'd	LUMP	SUM		
2202.1	Excavation	CY	1337				
2202.2	Shot Rock Borrow	CY	725				
2202.3	Sideslopes and Ditch Grading	Lump Sum	All Req'd	LUMP	SUM		
2202.4	Mining Area Restoration & Road Cleaning Guarantee	Contingent Sum	All Req'd	CONTINGENT	SUM	5000	00
2204.1	2-Inch Minus Shot Rock w/ Base Course	CY	476				
2401.1	Locate Sanitary Sewer Services	Lump Sum	All Req'd	LUMP	SUM		
2401.2	Sanitary Sewer Pipe 8-Inch PVC	LF	117.2				
2401.3	Sanitary Sewer 6-Inch HDPE Force Main	LF	513.9				
2401.4	Sanitary Sewer Service Lateral with Cleanout, 6-Inch	EA	5				
2401.5	Sanitary Sewer Service Cleanout	EA	4				
2402.1	Sanitary Sewer Manhole, Type I	EA	1				
2402.2	Remove and Replace Sanitary Sewer Manhole Cone	Lump Sum	All Req'd	LUMP	SUM		
2402.3	Reconstruct Sanitary Sewer Manhole	EA	2				
2402.4	Adjust Sanitary Sewer Manhole to Grade	EA	1				
2404.1	Waterproof Lift Station	Lump Sum	All Req'd	LUMP	SUM		
2501.1	12-Inch Pipe Culvert	LF	63.1				
2501.2	18-Inch Pipe Culvert	LF	94.5				
2501.3	24-Inch Pipe Culvert	LF	60.3				
2501.4	6-Inch Underdrain	LF	115.7				
2501.5	15-Inch PVC Slip Line Culvert	Lump Sum	All Req'd	LUMP	SUM		
2501.6	21-Inch PVC Slip Line Culvert	Lump Sum	All Req'd	LUMP	SUM		
2502.1	Storm Drain Manhole, Type I	EA	6				
2502.2	Catch Basin, Type III	EA	1				
2601.1	10-Inch HDPE Water Pipe	LF	585.3				
2601.2	Install Corrosion Protection Anode	EA	4				
2601.3	Connect to Existing Water Pipe	Lump Sum	All Req'd	LUMP	SUM		
2601.4	Temporary Water System	Lump Sum	All Req'd	LUMP	SUM		
2603.1	Fire Hydrant Assembly with Guard Posts	EA	2				
2605.1	Locate Water Services	Lump Sum	All Req'd	LUMP	SUM		
2605.2	Water Service, 1-Inch Polyethylene	EA	7				
2605.3	Water Service, 2-Inch HDPE	EA	1				
2607.1	Pipe Insulation	Boards	20				
2702.1	Construction Surveying	Lump Sum	All Req'd	LUMP	SUM		
2709.1	Topsoil	CY	20				
2709.2	Topsoil Finish Grading	MH	12				
2710.1	Seeding, Hydraulic Method, Type III	SU	1				
2716.1	Remove and Dispose of Storm and Sanitary Sewer Pipe	Lump Sum	All Req'd	LUMP	SUM		
2716.2	Fill Water Pipe with Slurry	Lump Sum	All Req'd	LUMP	SUM		
2717.1	Remove and Dispose of Storm and Sanitary Sewer Structures	Lump Sum	All Req'd	LUMP	SUM		
2719.1	Reconstruct Mailbox	EA	4				

**SECTION 00310 - BID SCHEDULE**

PAY ITEM NO.	PAY ITEM DESCRIPTION	PAY UNIT	APPROX. QUANTITY	UNIT PRICE		AMOUNT	
				DOLLARS	CENTS	DOLLARS	CENTS
2722.1	Utility Conduit Relocation	LF	250				
2801.1	Asphalt Concrete Pavement, Type II-A, Class B	Ton	445.1				
2806.1	Remove Existing Asphalt Surfacing	SY	2659				
3302.1	Concrete Headwall w/Trashrack	EA	3				
3302.2	Concrete Headwall	EA	1				
3303.1	ADA Ramps and Landings	Lump Sum	All Req'd	LUMP	SUM		
3303.2	Curb and Gutter, Type I	LF	1282				
3303.3	Valley Gutter, Type III	LF	182				
3304.1	Removal of Curb and Gutter	LF	1486				
3305.1	Remove and Reset Concrete Pavers	Lump Sum	All Req'd	LUMP	SUM		

**TOTAL BID: \$** \_\_\_\_\_

**COMPANY NAME:** \_\_\_\_\_

**SECTION 00320 - BID BOND**

KNOW ALL PERSONS BY THESE PRESENTS, that \_\_\_\_\_  
\_\_\_\_\_ as Principal, and \_\_\_\_\_  
as Surety, are held and firmly bound unto **THE CITY AND BOROUGH OF JUNEAU** hereinafter called  
"OWNER," in the sum of \_\_\_\_\_  
\_\_\_\_\_dollars, (not less than five percent of the total amount of the Bid) for the  
payment of which sum, well and truly to be made, we bind ourselves, our heirs, executors, administrators,  
successors, and assigns, jointly and severally, firmly by these presents.

WHEREAS, said Principal has submitted a Bid to said OWNER to perform the WORK required under  
the Bid Schedule of the OWNER's Contract Documents entitled.

**GOODWIN ROAD RECONSTRUCTION  
Contract No. BE21-179**

NOW THEREFORE, if said Principal is awarded a contract by said OWNER and, within the time and  
in the manner required in the "Notice Inviting Bids" and the "Instructions to Bidders" enters into a written  
Agreement on the form of Agreement bound with said Contract Documents, furnishes the required certificates  
of insurance, and furnishes the required Performance Bond and Payment Bond, then this obligation shall be  
null and void, otherwise it shall remain in full force and effect. In the event suit is brought upon this bond by  
said OWNER and OWNER prevails, said Surety shall pay all costs incurred by said OWNER in such suit,  
including a reasonable attorney's fee to be fixed by the court.

SIGNED AND SEALED, this \_\_\_\_\_ day of \_\_\_\_\_, 20\_\_\_\_

(SEAL) \_\_\_\_\_  
(Principal)

(SEAL) \_\_\_\_\_  
(Surety)

By: \_\_\_\_\_  
(Signature)

By: \_\_\_\_\_  
(Signature)

**END OF SECTION**

**SECTION 00360 - SUBCONTRACTOR REPORT**

**LIST OF SUBCONTRACTORS (AS 36.30.115)**

The apparent low Bidder must submit a list of Subcontractors that the Bidder proposes to use in the performance of this contract *on the fifth business day* following the Posting Notice of Bids. If the fifth day falls on a weekend or holiday, the report is due by close of business on the next business Day following the weekend or holiday. The Subcontractor Report list must include each Subcontractor's name, address, location, evidence of valid Alaska Business License, and valid Alaska Contractor's Registration under AS 08.18. *If no Subcontractors are to be utilized in the performance of the WORK, write in ink or type "NONE" on line (1) below.*

<u>SUBCONTRACTOR</u>	<sup>1</sup> AK Contractor License No.	<sup>1</sup> Contact Name	Type of	Contract	✓ if DBE
<u>ADDRESS</u>	<sup>2</sup> AK Business License No.	<sup>2</sup> Phone No.	<u>Work</u>	<u>Amount</u>	
1. _____ _____ _____	1 _____ 2 _____	_____ _____	_____ _____	\$ _____	<input type="checkbox"/>
2. _____ _____ _____	1 _____ 2 _____	_____ _____	_____ _____	\$ _____	<input type="checkbox"/>
3. _____ _____ _____	1 _____ 2 _____	_____ _____	_____ _____	\$ _____	<input type="checkbox"/>
4. _____ _____ _____	1 _____ 2 _____	_____ _____	_____ _____	\$ _____	<input type="checkbox"/>

I certify that the above listed Alaska Business License(s) and CONTRACTOR Registration(s), if applicable, were valid at the time Bids were opened for this Project.

\_\_\_\_\_  
CONTRACTOR, Authorized Signature

\_\_\_\_\_  
CONTRACTOR, Printed Name

\_\_\_\_\_  
COMPANY

## SECTION 00360 - SUBCONTRACTOR REPORT

- A. A Bidder may replace a listed Subcontractor if the Subcontractor:
1. fails to comply with AS 08.18;
  2. files for bankruptcy or becomes insolvent;
  3. fails to execute a contract with the Bidder involving performance of the WORK for which the Subcontractor was listed and the Bidder acted in good faith;
  4. fails to obtain bonding;
  5. fails to obtain insurance acceptable to the OWNER;
  6. fails to perform the contract with the Bidder involving work for which the Subcontractor was listed;
  7. must be substituted in order for the CONTRACTOR to satisfy required state and federal affirmative action requirements;
  8. refuses to agree or abide with the Bidder's labor agreement; or
  9. is determined by the OWNER not to be responsible.
  10. is not in "Good Standing" with the OWNER as required in Article 21.0 in Section 00100 – Instructions to Bidders.
- B. If a Bidder fails to list a Subcontractor or lists more than one Subcontractor for the same portion of WORK, the Bidder shall be considered to have agreed to perform that portion of WORK without the use of a Subcontractor and to have represented the Bidder to be qualified to perform that WORK.
- C. A Bidder who attempts to circumvent the requirements of this section by listing as a Subcontractor another contractor who, in turn, sublets the majority of the WORK required under the contract violates this section.
- D. If a contract is awarded to a Bidder who violates this section, the OWNER may:
1. cancel the contract; or
  2. after notice and a hearing, assess a penalty on the Bidder in an amount that does not exceed 10 percent of the value of the subcontract at issue.
- E. On the Subcontractor Report, the apparent low Bidder must list all Subcontractors anticipated to perform WORK on the project.
- F. An apparent low Bidder who fails to submit a completed Subcontractor Report within the time specified in this section may be found to be not a responsible Bidder and may be required to forfeit the Bid security. The OWNER will then consider the next lowest Bidder for award of the contract.

**END OF SECTION**

**SECTION 00370 - CONTRACTOR'S FINANCIAL RESPONSIBILITY**

To be considered, all bidders must complete and include this form *at the time of the deadline for bids*. Attach additional sheets as necessary to respond to questions.

**PROJECT: GOODWIN ROAD RECONSTRUCTION**

As the General Contractor on this project, I intend to subcontract \_\_\_\_\_% of the total value of this contract.

**A. EXPERIENCE**

1. Have you ever failed to complete a contract due to insufficient resources?

No  Yes If YES, explain:

---

---

---

---

2. Describe arrangements you have made to finance this work:

---

---

---

---

3. Have you had previous construction contracts or subcontracts with the City and Borough of Juneau?

Yes  No

4. Describe your most recent or current contract, its completion date, and scope of work:

---

---

---

---

---

---

5. List below, and/or as an attachment to this questionnaire, other construction projects you have completed, dates of completion, scope of work, and total contract amount for each project completed in the past twelve months.

---

---

---

---

---

---

**SECTION 00370 - CONTRACTOR'S FINANCIAL RESPONSIBILITY**

6. Per Alaska Statute 36.90.210, on previously awarded public contracts (including contracts still in progress), have you ever failed to pay a subcontractor or material supplier **within eight working days** after receiving payment from the Owner (for projects occurring within the last 3 years)?

Yes       No      If yes, please attach a detailed explanation for **each** occurrence.

**B. EQUIPMENT**

1. Describe below, and/or as an attachment, the equipment you have available and intend to use for this project.

ITEM	QUANTITY	MAKE	MODEL	SIZE/CAPACITY	PRESENT MARKET VALUE

2. Do you propose to purchase any equipment for use on this project not listed on table B-1?

No     Yes    If YES, describe type, quantity, and approximate cost:

---



---



---



---

3. Do you propose to rent any equipment for this work not listed on table B-1?

No     Yes    If YES, describe type and quantity:

---



---



---



---



---



**SECTION 00370 - CONTRACTOR'S FINANCIAL RESPONSIBILITY**

4. Is your bid based on firm offers for all materials necessary for this project?

Yes  No If NO, please explain:

---

---

---

---

---

---

**I hereby certify that the above statements are true and complete.**

\_\_\_\_\_  
Contractor Signature

\_\_\_\_\_  
Name and Title of Person Signing

\_\_\_\_\_  
Signature

\_\_\_\_\_  
Date

**SECTION 00500 - AGREEMENT**

THIS AGREEMENT is between THE CITY AND BOROUGH OF JUNEAU (hereinafter called OWNER) and \_\_\_\_\_ (hereinafter called CONTRACTOR) OWNER and CONTRACTOR, in consideration of the mutual covenants hereinafter set forth, agree as follows:

**ARTICLE 1. WORK.**

CONTRACTOR shall complete the WORK as specified or as indicated under the Bid Schedule of the OWNER's Bid Documents entitled **Contract No. BE21-179 Goodwin Road Reconstruction**

The WORK is generally described as follows: The WORK covered in the Contract Documents generally includes: Reconstruction of Goodwin Road from Blueberry Hills Road. WORK will include replacement of the water main and services, replacement of sanitary sewer force main and a segment of gravity sewer main, replacement of three sanitary sewer services, installation of two new sanitary sewer services, installation of sewer cleanouts, and installation of a new storm drain system. WORK will also include replacement of the roadway subbase to a depth of 18-inches, the installation of a new curb and gutter, and resurfacing with asphalt cement pavement.

The WORK to be paid under this contract shall include the following: Total Bid as shown in Section 00310 - Bid Schedule.

**ARTICLE 2. CONTRACT COMPLETION TIME** The WORK must be completed by September 1, 2021 or 90 days after start of WORK.

**ARTICLE 3. DATE OF AGREEMENT**

The date of this Agreement will be the date of the last signature on page three of this section.

**ARTICLE 4. LIQUIDATED DAMAGES.**

OWNER and the CONTRACTOR recognize that time is of the essence of this Agreement and that the OWNER will suffer financial loss if the WORK is not completed within the time specified in Article 2 herein, plus any extensions thereof allowed in accordance with Article 12 of the General Conditions. They also recognize the delays, expense, and difficulties involved in proving in a legal proceeding the actual damages suffered by the OWNER if the WORK is not completed on time. Accordingly, instead of requiring any such proof, the OWNER and the CONTRACTOR agree that as liquidated damages for delay (but not as a penalty) the CONTRACTOR shall pay the OWNER **\$ 400** for each Day that expires after the completion time specified in Article 2 herein. The amount of liquidated damages specified above is agreed to be a reasonable estimate based on all facts known as of the date of this Agreement.

**ARTICLE 5. CONTRACT PRICE.**

OWNER shall pay CONTRACTOR for completion of the WORK in accordance with the Contract Documents in the amount set forth in the Bid Schedule. The CONTRACTOR agrees to accept as full and complete payment for all WORK to be done in this contract for: **Contract No. BE21-179 Goodwin Road Reconstruction**, those Unit Price amounts as set forth in the Bid Schedule in the Contract Documents for this Project.

The total amount of this contract shall be \_\_\_\_\_ (\$ \_\_\_\_\_), except as adjusted in accordance with the provisions of the Bid Documents.

## SECTION 00500 - AGREEMENT

### ARTICLE 6. PAYMENT PROCEDURES.

CONTRACTOR shall submit Applications for Payment in accordance with Article 14 of the General Conditions. Applications for Payment will be processed by the ENGINEER as provided in the General Conditions.

Progress payments will be paid in full in accordance with Article 14 of the General Conditions until ninety (90) percent of the Contract Price has been paid. The remaining ten (10) percent of the Contract Price may be retained, in accordance with applicable Alaska State Statutes, until final inspection, completion, and acceptance of the Project by the OWNER.

### ARTICLE 7. CONTRACT DOCUMENTS.

The Contract Documents which comprise the entire Agreement between OWNER and CONTRACTOR concerning the WORK consist of this Agreement (pages 00500-1 to 00500-6, inclusive) and the following sections of the Contract Documents:

- Table of Contents (pages 00005-1 to 00005-2, inclusive)
- Notice Inviting Bids (pages 00030-1 to 00030-2, inclusive).
- Instructions to Bidders (pages 00100-1 to 00100-9, inclusive).
- Bid (pages 00300-1 to 00300-2, inclusive).
- Bid Schedule (pages 00310-1, inclusive).
- Bid Bond (page 00320-1, inclusive) or Bid Security.
- Subcontractor Report (pages 00360-1 to 00360-2, inclusive).
- Contractor Financial Responsibility (pages 00370-1 to 00370-3, inclusive).
- Performance Bond (pages 00610-1 to 00610-2, inclusive).
- Payment Bond (pages 00620-1 to 00620-2, inclusive).
- Insurance Certificate(s).
- General Conditions (pages 00700-1 to 00700-48, inclusive).
- Supplementary General Conditions (pages 00800-1 to 00800-5, inclusive).
- Alaska Labor Standards, Reporting, and Prevailing Wage Determination (page 00830-1).
- Standard Details (page 00853-1).
- Special Provisions (pages 1 to 44 inclusive)
- Drawings consisting of 14 sheets, as listed in the Table of Contents.
- Addenda numbers \_\_\_\_\_ to \_\_\_\_\_, inclusive.
- Change Orders which may be delivered or issued after the Date of the Agreement and which are not attached hereto.

There are no Contract Documents other than those listed in this Article 7. The Contract Documents may only be amended by Change Order as provided in Paragraph 3.3 of the General Conditions.

### ARTICLE 8. MISCELLANEOUS.

Terms used in this Agreement which are defined in Article 1 of the General Conditions will have the meanings indicated in the General Conditions.

**SECTION 00500 - AGREEMENT**

**ARTICLE 8. MISCELLANEOUS. (Cont'd.)**

No assignment by a party hereto of any rights under or interests in the Contract Documents will be binding on another party hereto without the written consent of the party sought to be bound; and specifically but without limitation monies that may become due and monies that are due may not be assigned without such consent (except to the extent that the effect of this restriction may be limited by law), and unless specifically stated to the contrary in any written consent to an assignment, no assignment will release or discharge the assignor from any duty or responsibility under the Contract Documents.

OWNER and CONTRACTOR each binds itself, its partners, successors, assigns and legal representatives to the other party hereto, its partners, successors, assigns and legal representatives in respect of all covenants, agreements and obligations contained in the Contract Documents. This Agreement shall be governed by the laws of the State of Alaska. Jurisdiction shall be in the State of Alaska, First Judicial District.

IN WITNESS WHEREOF, OWNER and CONTRACTOR have caused this Agreement to be executed on the date listed below by OWNER.

**OWNER:**

**CONTRACTOR:**

\_\_\_\_\_  
City and Borough of Juneau

\_\_\_\_\_  
(Company Name)

\_\_\_\_\_  
(Signature)

\_\_\_\_\_  
(Signature)

By: Duncan Rorie Watt, City & Borough Manager  
(Printed Name)

By: \_\_\_\_\_  
(Printed Name, Authority or Title)

Date: \_\_\_\_\_

CONTRACTOR Signature Date: \_\_\_\_\_

OWNER's address for giving notices:

CONTRACTOR's address for giving notices:

\_\_\_\_\_  
155 South Seward Street

\_\_\_\_\_

\_\_\_\_\_  
Juneau, Alaska 99801

\_\_\_\_\_

\_\_\_\_\_  
907-586-0873      907-586-4530  
(Telephone)      (Fax)

\_\_\_\_\_  
(Telephone)      (Fax)

\_\_\_\_\_  
(E-mail address)

Contractor License No. \_\_\_\_\_

**SECTION 00500 - AGREEMENT**

**CERTIFICATE  
(if Corporation)**

STATE OF            )  
                          ) SS:  
COUNTY OF        )

I HEREBY CERTIFY that a meeting of the Board of Directors of the  
\_\_\_\_\_ a corporation existing under the laws of  
the State of \_\_\_\_\_, held on \_\_\_\_\_, 20\_\_\_\_, the following resolution  
was duly passed and adopted:

“RESOLVED, that \_\_\_\_\_, as \_\_\_\_\_ President  
of the Corporation, be and is hereby authorized to **execute the Agreement** with the CITY AND  
BOROUGH OF JUNEAU and this corporation and that the execution thereof, attested by the  
Secretary of the Corporation, and with the Corporate Seal affixed, shall be the official act and deed  
of this Corporation.”

I further certify that said resolution is now in full force and effect.

IN WITNESS WHEREOF, I have hereunto set my hand and affixed the official seal of the  
corporation this \_\_\_\_\_ day of \_\_\_\_\_, 20\_\_\_\_\_.

\_\_\_\_\_  
Secretary

(SEAL)

SECTION 00500 - AGREEMENT

CERTIFICATE  
(if Partnership)

STATE OF )  
 ) SS:  
COUNTY OF )

I HEREBY CERTIFY that a meeting of the Partners of the

\_\_\_\_\_ a partnership existing under the laws of the State

of \_\_\_\_\_, held on \_\_\_\_\_, 20\_\_\_\_, the following resolution was duly passed and adopted:

"RESOLVED, that \_\_\_\_\_, as \_\_\_\_\_ of the Partnership, be and is hereby authorized to **execute the Agreement** with the CITY AND BOROUGH OF JUNEAU and this partnership and that the execution thereof, attested by the \_\_\_\_\_ shall be the official act and deed of this Partnership."

I further certify that said resolution is now in full force and effect.

IN WITNESS WHEREOF, I have hereunto set my hand this \_\_\_\_\_, day of \_\_\_\_\_, 20\_\_\_\_\_.

\_\_\_\_\_  
Secretary

(SEAL)

**SECTION 00500 - AGREEMENT**

**CERTIFICATE  
(if Joint Venture)**

STATE OF            )  
                          ) SS:  
COUNTY OF    )

I HEREBY CERTIFY that a meeting of the Principals of the  
\_\_\_\_\_ a joint venture existing under the laws of the  
State of \_\_\_\_\_, held on \_\_\_\_\_, 20\_\_\_\_, the following resolution was duly passed and  
adopted:

"RESOLVED, that \_\_\_\_\_, as \_\_\_\_\_ of the  
Joint Venture, be and is hereby authorized to **execute the Agreement** with the CITY AND  
BOROUGH OF JUNEAU and this joint venture and that the execution thereof, attested by the  
\_\_\_\_\_ shall be the official act and deed of this Joint Venture."

I further certify that said resolution is now in full force and effect.

IN WITNESS WHEREOF, I have hereunto set my hand this \_\_\_\_\_, day of  
\_\_\_\_\_, 20\_\_\_\_.

\_\_\_\_\_  
Secretary

(SEAL)

**END OF SECTION**

**SECTION 00610 - PERFORMANCE BOND**

KNOW ALL PERSONS BY THESE PRESENTS: That we \_\_\_\_\_  
(Name of Contractor)

\_\_\_\_\_ a \_\_\_\_\_  
(Corporation, Partnership, Individual)

hereinafter called "Principal" and \_\_\_\_\_  
(Surety)

of \_\_\_\_\_, State of \_\_\_\_\_ hereinafter called the "Surety," are held and  
firmly bound to the CITY AND BOROUGH of JUNEAU, ALASKA hereinafter called "OWNER,"  
(Owner) (City and State)

for the penal sum of \_\_\_\_\_

\_\_\_\_\_ dollars (\$ \_\_\_\_\_) in lawful money of the  
United States, for the payment of which sum well and truly to be made, we bind ourselves, our heirs, executors,  
administrators and successors, jointly and severally, firmly by these presents.

THE CONDITION OF THIS OBLIGATION is such that whereas, the CONTRACTOR has entered  
into a certain contract with the OWNER, the effective date of which is (CBJ Contracts Office to fill in effective  
date) \_\_\_\_\_, a copy of which is hereto attached and made a part hereof for the  
construction of:

**Goodwin Road Reconstruction  
CBJ Contract No. BE21-179**

NOW, THEREFORE, if the Principal shall truly and faithfully perform its duties, all the undertakings,  
covenants, terms, conditions, and agreements of said contract during the original term thereof, and any  
extensions thereof, which may be granted by the OWNER, with or without notice to the Surety, and if it shall  
satisfy all claims and demands incurred under such contract, and shall fully indemnify and save harmless the  
OWNER from all costs and damages which it may suffer by reason of failure to do so, and shall reimburse and  
repay the OWNER all outlay and expense which the OWNER may incur in making good any default, then this  
obligation shall be void; otherwise to remain in full force and effect.

PROVIDED, FURTHER, that the said Surety, for value received hereby stipulates and agrees that no  
change, extension of time, alteration or addition to the terms of the contract or to the WORK to be performed  
thereunder or the specifications accompanying the same shall in any wise affect its obligation on this bond, and  
it does hereby waive notice of any such change, extension of time, alteration or addition to the terms of the  
contract or to the WORK or to the Specifications.

PROVIDED, FURTHER, that no final settlement between the OWNER and the Principal shall abridge  
the right of any beneficiary hereunder, whose claim may be unsatisfied.



**SECTION 00610 - PERFORMANCE BOND**

**Goodwin Road Reconstruction  
CBJ Contract No. BE21-179**

IN WITNESS WHEREOF, this instrument is issued in two (2) identical counterparts, each one of which shall be deemed an original.

**CONTRACTOR:**

By: \_\_\_\_\_  
(Signature)

\_\_\_\_\_  
(Printed Name)

\_\_\_\_\_  
(Company Name)

\_\_\_\_\_  
(Mailing Address)

\_\_\_\_\_  
(City, State, Zip Code)

**SURETY:**

By: \_\_\_\_\_  
(Signature of Attorney-in-Fact)

Date Issued: \_\_\_\_\_

\_\_\_\_\_  
(Printed Name)

\_\_\_\_\_  
(Company Name)

\_\_\_\_\_  
(Mailing Address)

\_\_\_\_\_  
(City, State, Zip Code)

**(Affix SURETY'S SEAL)**

**NOTE: If CONTRACTOR is Partnership, all Partners must execute bond.**

**END OF SECTION**

**SECTION 00620 - PAYMENT BOND**

KNOW ALL PERSONS BY THESE PRESENTS: That we \_\_\_\_\_  
(Name of Contractor)

\_\_\_\_\_ a \_\_\_\_\_  
(Corporation, Partnership, Individual)

hereinafter called "Principal" and \_\_\_\_\_  
(Surety)

of \_\_\_\_\_, State of \_\_\_\_\_ hereinafter called the "Surety," are held and  
firmly bound to the CITY AND BOROUGH of JUNEAU, ALASKA hereinafter called "OWNER,"  
(Owner) (City and State)

for the penal sum of \_\_\_\_\_

\_\_\_\_\_ dollars (\$ \_\_\_\_\_) in lawful money of the  
United States, for the payment of which sum well and truly to be made, we bind ourselves, our heirs, executors,  
administrators and successors, jointly and severally, firmly by these presents.

THE CONDITION OF THIS OBLIGATION is such that whereas, the CONTRACTOR has entered  
into a certain contract with the OWNER, the effective date of which is (CBJ Contracts Office to fill in effective  
date) \_\_\_\_\_, a copy of which is hereto attached and made a part hereof for the  
construction of:

**Goodwin Road Reconstruction  
CBJ Contract No. BE21-179**

NOW, THEREFORE, if the Principal shall promptly make payment to all persons, firms,  
Subcontractors, and corporations furnishing materials for, or performing labor in the prosecution of the WORK  
provided for in such contract, and any authorized extension or modification thereof, including all amounts due  
for materials, lubricants, oil, gasoline, coal and coke, repairs on machinery, equipment and tools, consumed or  
used in connection with the construction of such WORK, and all insurance premiums on said work, and for all  
labor performed in such WORK, whether by Subcontractor or otherwise, then this obligation shall be void;  
otherwise to remain in full force and effect.

PROVIDED, FURTHER, that the said Surety, for value received hereby stipulates and agrees that no  
change, extension of time, alteration or addition to the terms of the contract or to the work to be performed  
thereunder or the specifications accompanying the same shall in any wise affect its obligation on this bond, and  
it does hereby waive notice of any such change, extension of time, alteration or addition to the terms of the  
contract or to the WORK or to the Specifications.

PROVIDED, FURTHER, that no final settlement between the OWNER and the Principal shall abridge  
the right of any beneficiary hereunder, whose claim may be unsatisfied.

**SECTION 00620 - PAYMENT BOND**

**Goodwin Road Reconstruction  
CBJ Contract No. BE21-179**

IN WITNESS WHEREOF, this instrument is issued in two (2) identical counterparts, each one of which shall be deemed an original.

**CONTRACTOR:**

By: \_\_\_\_\_  
(Signature)

\_\_\_\_\_  
(Printed Name)

\_\_\_\_\_  
(Company Name)

\_\_\_\_\_  
(Mailing Address)

\_\_\_\_\_  
(City, State, Zip Code)

**SURETY:**

By: \_\_\_\_\_  
(Signature of Attorney-in-Fact)

Date Issued: \_\_\_\_\_

\_\_\_\_\_  
(Printed Name)

\_\_\_\_\_  
(Company Name)

\_\_\_\_\_  
(Mailing Address)

\_\_\_\_\_  
(City, State, Zip Code)

**(Affix SURETY'S SEAL)**

**NOTE: If CONTRACTOR is Partnership, all Partners must execute bond.**

**END OF SECTION**

**SECTION 00700 - GENERAL CONDITIONS**

**TABLE OF CONTENTS**  
**(Revised 03-2003)**

**ARTICLE 1 DEFINITIONS** ..... 00700-5

**ARTICLE 2 PRELIMINARY MATTERS**

2.1 Delivery of Bonds/Insurance Certificates ..... 00700-9  
2.2 Copies of Documents ..... 00700-9  
2.3 Commencement of Contract Time; Notice to Proceed ..... 00700-9  
2.4 Starting the WORK ..... 00700-9  
2.5 Pre-construction Conference ..... 00700-9  
2.6 Finalizing CONTRACTOR Submittals..... 00700-9

**ARTICLE 3 CONTRACT DOCUMENTS: INTENT, AMENDING, REUSE**

3.1 Intent ..... 00700-10  
3.2 Order of Precedence of Contract Documents ..... 00700-10  
3.3 Amending and Supplementing Contract Documents..... 00700-11  
3.4 Reuse of Documents..... 00700-11

**ARTICLE 4 AVAILABILITY OF LANDS; PHYSICAL CONDITIONS; REFERENCE POINTS**

4.1 Availability of Lands ..... 00700-11  
4.2 Physical Conditions - Subsurface and Existing Structures ..... 00700-11  
4.3 Differing Site Conditions ..... 00700-12  
4.4 Physical Conditions - Underground Utilities ..... 00700-12  
4.5 Reference Points..... 00700-13  
4.6 Use of the CBJ/State Lemon Creek Gravel Pit ..... 00700-13

**ARTICLE 5 BONDS AND INSURANCE**

5.1 Performance, Payment and Other Bonds ..... 00700-14  
5.2 Insurance ..... 00700-15

**ARTICLE 6 CONTRACTOR'S RESPONSIBILITIES**

6.1 Supervision and Superintendence..... 00700-17  
6.2 Labor, Materials, and Equipment ..... 00700-17  
6.3 Adjusting Progress Schedule..... 00700-18  
6.4 Substitutes or "Or Equal" Items..... 00700-19  
6.5 Concerning Subcontractors, Suppliers and Others ..... 00700-19  
6.6 Permits..... 00700-19  
6.7 Patent Fees and Royalties ..... 00700-20  
6.8 Laws and Regulations..... 00700-20

**SECTION 00700 - GENERAL CONDITIONS**

**ARTICLE 6 CONTRACTOR'S RESPONSIBILITIES (Cont'd.)**

6.9 Taxes ..... 00700-20  
6.10 Use of Premises ..... 00700-20  
6.11 Safety and Protection..... 00700-21  
6.12 Shop Drawings and Samples ..... 00700-22  
6.13 Continuing the WORK..... 00700-22  
6.14 Indemnification ..... 00700-22  
6.15 Contractor's Daily Reports..... 00700-23  
6.16 Assignment of Contract..... 00700-23  
6.17 Contractor's Responsibility for Utility Property and Services ..... 00700-23  
6.18 Operating Water System Valves ..... 00700-24  
6.19 CONTRACTOR's WORK Schedule Limitations ..... 00700-24

**ARTICLE 7 OTHER WORK**

7.1 Related WORK at Site ..... 00700-24  
7.2 Coordination..... 00700-25

**ARTICLE 8 OWNER'S RESPONSIBILITIES**

8.1 Communications..... 00700-25  
8.2 Payments ..... 00700-25  
8.3 Lands, Easements, and Surveys..... 00700-25  
8.4 Change Orders..... 00700-25  
8.5 Inspections and Tests..... 00700-25  
8.6 Suspension of WORK ..... 00700-25  
8.7 Termination of Agreement ..... 00700-25

**ARTICLE 9 ENGINEER'S STATUS DURING CONSTRUCTION**

9.1 OWNER 's Representative ..... 00700-25  
9.2 Visits to Site ..... 00700-25  
9.3 Project Representation..... 00700-26  
9.4 Clarifications and Interpretations..... 00700-28  
9.5 Authorized Variations in WORK ..... 00700-28  
9.6 Rejecting Defective WORK ..... 00700-28  
9.7 CONTRACTOR Submittals, Change Orders, and Payments ..... 00700-28  
9.8 Decisions on Disputes ..... 00700-28  
9.9 Limitation on Engineer's Responsibilities ..... 00700-29

**SECTION 00700 - GENERAL CONDITIONS**

**ARTICLE 10 CHANGES IN THE WORK**

10.1 General ..... 00700-30  
10.2 Allowable Quantity Variations ..... 00700-30

**ARTICLE 11 CHANGE OF CONTRACT PRICE**

11.1 General ..... 00700-31  
11.2 Costs Relating to Weather ..... 00700-31  
11.3 Cost of WORK (Based on Time and Materials)..... 00700-32  
11.4 CONTRACTOR's Fee..... 00700-34  
11.5 Excluded Costs..... 00700-35

**ARTICLE 12 CHANGE OF CONTRACT TIME**

12.1 General ..... 00700-36  
12.2 Extensions of Time for Delay Due to Weather..... 00700-36

**ARTICLE 13 WARRANTY AND GUARANTEE; TESTS AND INSPECTIONS;  
CORRECTION, REMOVAL, OR ACCEPTANCE OF DEFECTIVE WORK**

13.1 Warranty and Guarantee..... 00700-37  
13.2 Access to WORK ..... 00700-37  
13.3 Tests and Inspections..... 00700-37  
13.4 OWNER May Stop the WORK..... 00700-38  
13.5 Correction or Removal of Defective WORK..... 00700-38  
13.6 One Year Correction Period ..... 00700-39  
13.7 Acceptance of Defective WORK..... 00700-39

**ARTICLE 14 PAYMENTS TO CONTRACTOR AND COMPLETION**

14.1 Schedule of Values (Lump Sum Price Breakdown) ..... 00700-39  
14.2 Unit Price Bid Schedule ..... 00700-39  
14.3 Application for Progress Payment ..... 00700-39  
14.4 CONTRACTOR's Warranty of Title ..... 00700-40  
14.5 Review of Applications for Progress Payment ..... 00700-40  
14.6 Partial Utilization ..... 00700-41  
14.7 Substantial Completion ..... 00700-41  
14.8 Final Application for Payment..... 00700-41  
14.9 Final Payment and Acceptance..... 00700-42  
14.10 Release of Retainage and Other Deductions..... 00700-42  
14.11 CONTRACTOR's Continuing Obligation..... 00700-42  
14.12 Final Payment Terminates Liability of OWNER ..... 00700-43

**SECTION 00700 - GENERAL CONDITIONS**

**ARTICLE 15 SUSPENSION OF WORK AND TERMINATION**

15.1 Suspension of WORK by OWNER..... 00700-43  
15.2 Termination of Agreement by OWNER (CONTRACTOR Default)..... 00700-43  
15.3 Termination of Agreement by OWNER (For Convenience) ..... 00700-43  
15.4 Termination of Agreement by CONTRACTOR..... 00700-44

**ARTICLE 16 MISCELLANEOUS**

16.1 Giving Notice ..... 00700-44  
16.2 Rights In and Use of Materials Found on the WORK ..... 00700-44  
16.3 Right to Audit..... 00700-45  
16.4 Archaeological or Historical Discoveries ..... 00700-45  
16.5 Construction Over or Adjacent to Navigable Waters ..... 00700-45  
16.6 Gratuity and Conflict of Interest..... 00700-45  
16.7 Suits of Law Concerning the WORK ..... 00700-46  
16.8 Certified Payrolls..... 00700-46  
16.9 Prevailing Wage Rates ..... 00700-46  
16.10 Employment Reference ..... 00700-47  
16.11 Cost Reduction Incentive ..... 00700-47

## **SECTION 00700 - GENERAL CONDITIONS**

### **ARTICLE 1 DEFINITIONS**

Wherever used in these General Conditions or in the Contract Documents the following terms have the meanings indicated which are applicable to both the singular and plural thereof. Where an entire word is capitalized in the definitions and is found not capitalized in the Contract Documents it has the ordinary dictionary definition.

Addenda - Written or graphic instruments issued prior to the opening of Bids which make additions, deletions, or revisions to the Contract Documents.

Agreement - The written contract between the OWNER and the CONTRACTOR covering the WORK to be performed; other documents are attached to the Agreement and made a part thereof as provided therein.

Application for Payment - The form furnished by the ENGINEER which is to be used by the CONTRACTOR to request progress or final payment and which is to be accompanied by such supporting documentation as is required by the Contract Documents.

Asbestos - Any material that contains more than one percent asbestos and is friable or is releasing asbestos fibers into the air above current action levels established by the United States Occupational Safety and Health Administration.

Bid - The offer or proposal of the Bidder submitted on the prescribed form setting forth the price or prices for the WORK.

Bonds - Bid, Performance, and Payment Bonds and other instruments which protect against loss due to inability or refusal of the CONTRACTOR to perform its contract.

CBJ Project Manager - The authorized representative of the City and Borough of Juneau Engineering Department, as OWNER, who is responsible for administration of the contract.

Change Order - A document recommended by the ENGINEER, which is signed by the CONTRACTOR and the OWNER and authorizes an addition, deletion, or revision in the WORK, or an adjustment in the Contract Price or the Contract Time, issued on or after the Effective Date of the Agreement.

Contract Documents - The Table of Contents, Notice Inviting Bids, Instructions to Bidders, Bid Forms (including the Bid, Bid Schedule(s), Information Required of Bidder, Bid Bond, and all required certificates and affidavits), Agreement, Performance Bond, Payment Bond, General Conditions, Supplementary General Conditions, Technical Specifications, Drawings, Permits, and all Addenda, and Change Orders executed pursuant to the provisions of the Contract Documents.

Contract Price - The total monies payable by the OWNER to the CONTRACTOR under the terms and conditions of the Contract Documents.

Contract Time - The number of successive calendar Days stated in the Contract Documents for the completion of the WORK.

CONTRACTOR - The individual, partnership, corporation, joint-venture or other legal entity with whom the OWNER has executed the Agreement.



## SECTION 00700 - GENERAL CONDITIONS

Day - A calendar day of 24 hours measured from midnight to the next midnight.

Defective WORK - WORK that is unsatisfactory, faulty, or deficient; or that does not conform to the Contract Documents; or that does not meet the requirements of any inspection, reference standard, test, or approval referred to in the Contract Documents; or WORK that has been damaged prior to the ENGINEER's recommendation of final payment.

Drawings - The Drawings, plans, maps, profiles, diagrams, and other graphic representations which indicate the character, location, nature, extent, and scope of the WORK and which have been prepared by the ENGINEER and are referred to in the Contract Documents. Shop Drawings are not within the meaning of this paragraph.

Effective Date of the Agreement - The date indicated in the Agreement on which it becomes effective, but if no such date is indicated it means the date on which the Agreement is signed and delivered by the last of the two parties to sign and deliver.

Engineer of Record - The individual, partnership, corporation, joint-venture or other legal entity named as such in the Contract Documents.

ENGINEER - The ENGINEER is the firm or person(s) selected by the City and Borough of Juneau (CBJ) to perform the duties of project inspection and management. CBJ will inform the CONTRACTOR of the identity of the ENGINEER at or before the Notice to Proceed.

Field Order - A written order issued by the ENGINEER which may or may not involve a change in the WORK.

General Requirements - Division 1 of the Technical Specifications.

Hazardous Waste - The term Hazardous Waste shall have the meaning provided in Section 1004 of the Solid Waste Disposal Act (42 USC Section 9603) as amended from time to time.

Holidays - The CBJ legal holidays occur on:

1. New Year's Day - January 1
2. Martin Luther King's Birthday - Third Monday in January
3. President's Day - Third Monday in February
4. Seward's Day - Last Monday in March
5. Memorial Day - Last Monday in May
6. Independence Day - July 4
7. Labor Day - First Monday in September
8. Alaska Day - October 18
9. Veteran's Day - November 11
10. Thanksgiving Day - Fourth Thursday and the following Friday in November
11. Christmas Day - December 25

If any holiday listed above falls on a Saturday, Saturday and the preceding Friday are both legal holidays. If the holiday should fall on a Sunday, Sunday and the following Monday are both legal holidays.

## SECTION 00700 - GENERAL CONDITIONS

Inspector - The authorized representative of the ENGINEER assigned to make detailed inspections for conformance to the Contract Documents. Any reference to the Resident Project Representative in this document shall mean the Inspector.

Laws and Regulations; Laws or Regulations - Any and all applicable laws, rules, regulations, ordinances, codes, and/or orders of any and all governmental bodies, agencies, authorities and courts having jurisdiction.

Mechanic's Lien - A form of security, an interest in real property, which is held to secure the payment of an obligation. When referred to in these Contract Documents, "Mechanic's Lien" or "lien" means "Stop Notice".

Milestone - A principal event specified in the Contract Documents relating to an intermediate completion date of a portion of the WORK, or a period of time within which the portion of the WORK should be performed prior to Substantial Completion of all the WORK.

Notice of Award - The written notice by the OWNER to the apparent successful bidder stating that the apparent successful bidder has complied with all conditions for award of the contract.

Notice of Completion - A form signed by the ENGINEER and the CONTRACTOR recommending to the OWNER that the WORK is Substantially Complete and fixing the date of Substantial Completion. After acceptance of the WORK by the OWNER's governing body, the form is signed by the OWNER and filed with the County Recorder. This filing starts the 30-day lien filing period on the WORK.

Notice to Proceed - The written notice issued by the OWNER to the CONTRACTOR authorizing the CONTRACTOR to proceed with the WORK and establishing the date of commencement of the Contract Time.

Notice of Intent to Award - The written notice by the OWNER to the apparent successful bidder stating that upon compliance by the apparent successful bidder with the requirements listed therein, within the time specified, the OWNER will enter into an Agreement.

OWNER - The City and Borough of Juneau (CBJ), acting through its legally designated officials, officers, or employees.

Partial Utilization - Use by the OWNER or a substantially completed part of the WORK for the purpose for which it is intended prior to Substantial Completion of all the WORK.

PCB's - Polychlorinated biphenyls.

PERMITTEE – See definition for CONTRACTOR.

Petroleum - Petroleum, including crude oil or any fraction thereof which is liquid at standard conditions of temperature and pressure (60 degrees Fahrenheit and 14.7 pounds per square inch absolute), such as oil, petroleum, fuel oil, oil sludge, oil refuse, gasoline, kerosene, and oil mixed with other non-Hazardous Wastes and crude oils.

Project - The total construction of which the WORK to be provided under the Contract Documents may be the whole, or a part as indicated elsewhere in the Contract Documents.

## **SECTION 00700 - GENERAL CONDITIONS**

Radioactive Material - Source, special nuclear, or byproduct material as defined by the Atomic Energy Act of 1954 (42 USC Section 2011 et seq.) as amended from time to time.

Shop Drawings - All Drawings, diagrams, illustrations, schedules and other data which are specifically prepared by or for the CONTRACTOR and submitted by the CONTRACTOR, to the ENGINEER, to illustrate some portion of WORK.

Specifications - Same definition as "Technical Specifications" hereinafter.

Stop Notice - A legal remedy for Subcontractors and suppliers who contribute to public works, but who are not paid for their WORK, which secures payment from construction funds possessed by the OWNER. For public property, the Stop Notice remedy is designed to substitute for mechanic's lien rights.

Sub-Consultant - The individual, partnership, corporation, joint-venture or other legal entity having a direct contract with ENGINEER, or with any of its Consultants to furnish services with respect to the Project.

Subcontractor - An individual, partnership, corporation, joint-venture or other legal entity having a direct contract with the CONTRACTOR, or with any of its Subcontractors, for the performance of a part of the WORK at the site.

Substantial Completion - Refers to when the WORK has progressed to the point where, in the opinion of the ENGINEER as evidenced by Notice of Completion as applicable, it is sufficiently complete, in accordance with the Contract Documents, so that the WORK can be utilized for the purposes for which it is intended; or if no such notice is issued, when final payment is due in accordance with Paragraph 14.8. The terms "substantially complete" and "substantially completed" as applied to any WORK refer to substantial completion thereof.

Supplementary General Conditions (SGC) - The part of the Contract Documents which make additions, deletions, or revisions to these General Conditions.

Supplier - A manufacturer, fabricator, supplier, distributor, materialman, or vendor.

Technical Specifications - Divisions 1 through 16 of the Contract Documents consisting of the General Requirements and written technical descriptions of products and execution of the WORK.

Underground Utilities - All pipelines, conduits, ducts, cables, wires, manholes, vaults, tanks, tunnels, or other such facilities or attachments, and any encasements containing such facilities which have been installed underground to furnish any of the following services or materials: water, sewage and drainage removal, electricity, gases, steam, liquid petroleum products, telephone or other communications, cable television, traffic, or other control systems.

WORK, Work - The entire completed construction or the various separately identifiable parts thereof required to be furnished under the Contract Documents. WORK is the result of performing, or furnishing labor and furnishing and incorporating materials and equipment into the construction, and performing or furnishing services and furnishing documents, all as required by the Contract Documents.

## SECTION 00700 - GENERAL CONDITIONS

### ARTICLE 2 PRELIMINARY MATTERS

- 2.1 DELIVERY OF BONDS/INSURANCE CERTIFICATES. When the CONTRACTOR delivers the signed Agreements to the OWNER, the CONTRACTOR shall also deliver to the OWNER such Bonds and Insurance Policies and Certificates as the CONTRACTOR may be required to furnish in accordance with the Contract Documents.
- 2.2 COPIES OF DOCUMENTS. The OWNER shall furnish to the CONTRACTOR the required number of copies of the Contract Documents specified in the Supplementary General Conditions.
- 2.3 COMMENCEMENT OF CONTRACT TIME; NOTICE TO PROCEED. The Contract Time will start to run on the commencement date stated in the Notice to Proceed.
- 2.4 STARTING THE WORK
- A. The CONTRACTOR shall begin to perform the WORK within 10 days after the commencement date stated in the Notice to Proceed, but no WORK shall be done at the site prior to said commencement date.
  - B. Before undertaking each part of the WORK, the CONTRACTOR shall carefully study and compare the Contract Documents and check and verify pertinent figures shown thereon and all applicable field measurements. The CONTRACTOR shall promptly report in writing to the ENGINEER any conflict, error, or discrepancy which the CONTRACTOR may discover and shall obtain a written interpretation or clarification from the ENGINEER before proceeding with any WORK affected thereby.
  - C. The CONTRACTOR shall submit to the ENGINEER for review those documents called for under Section 01300 - CONTRACTOR Submittals in the General Requirements.
- 2.5 PRE-CONSTRUCTION CONFERENCE. The CONTRACTOR is required to attend a Pre-Construction Conference. This conference will be attended by the ENGINEER and others as appropriate in order to discuss the WORK in accordance with the applicable procedures specified in the General Requirements, Section 01010 - Summary of WORK in the General Requirements.
- 2.6 FINALIZING CONTRACTOR SUBMITTALS. At least 7 days before submittal of the first Application for Payment a conference attended by the CONTRACTOR, the ENGINEER and others as appropriate will be held to finalize the initial CONTRACTOR submittals in accordance with the General Requirements. As a minimum the CONTRACTOR's representatives should include the project manager and schedule expert. The CONTRACTOR should plan on this meeting taking no less than 8 hours. If the submittals are not finalized at the end of the meeting, additional meetings will be held so that the submittals can be finalized prior to the submittal of the first application for payment. No application for payment will be processed until CONTRACTOR submittals are finalized.

## SECTION 00700 - GENERAL CONDITIONS

### ARTICLE 3 CONTRACT DOCUMENTS: INTENT, AMENDING, REUSE

#### 3.1 INTENT

- A. The Contract Documents comprise the entire Agreement between the OWNER and the CONTRACTOR concerning the WORK. The Contract Documents shall be construed as a whole in accordance with Alaska Law.
- B. It is the intent of the Contract Documents to describe the WORK, functionally complete, to be constructed in accordance with the Contract Documents. Any work, materials, or equipment that may reasonably be inferred from the Contract Documents as being required to produce the intended result shall be supplied whether or not specifically called for. When words or phrases which have a well-known technical or construction industry or trade meaning are used to describe work, materials, or equipment such words or phrases shall be interpreted in accordance with that meaning, unless a definition has been provided in Article 1 of the General Conditions. Reference to standard specifications, manuals, or codes of any technical society, organization, or association, or to the Laws or Regulations of any governmental authority, whether such reference be specific or by implication, shall mean the latest standard specification, manual, code, or Laws or Regulations in effect at the time of opening of Bids, except as may be otherwise specifically stated. However, no provision of any referenced standard specification, manual, or code (whether or not specifically incorporated by reference in the Contract Documents) shall be effective to change the duties and responsibilities of the OWNER, the CONTRACTOR, or the ENGINEER or any of their consultants, agents, or employees from those set forth in the Contract Documents.
- C. If, during the performance of the WORK, CONTRACTOR discovers any conflict, error, ambiguity or discrepancy within the Contract Documents or between the Contract Documents and any provision of any such Law or Regulation applicable to the performance of the WORK or of any such standard, specification, manual or code or of any instruction of any Supplier referred to in paragraph 6.5, the CONTRACTOR shall report it to the ENGINEER in writing at once, and the CONTRACTOR shall not proceed with the WORK affected thereby (except in an emergency as authorized by the ENGINEER) until a clarification field order, or Change Order to the Contract Documents has been issued.

#### 3.2 ORDER OF PRECEDENCE OF CONTRACT DOCUMENTS

- A. In resolving conflicts resulting from, errors, or discrepancies in any of the Contract Documents, the order of precedence shall be as follows:
  - 1. Permits from other agencies as may be required by law, excepting the definition of "PERMITEE" in these permits.
  - 2. Field Orders
  - 3. Change Orders
  - 4. ENGINEER's written interpretations and clarifications.
  - 5. Agreement
  - 6. Addenda
  - 7. CONTRACTOR's Bid (Bid Form)
  - 8. Supplementary General Conditions
  - 9. Notice Inviting Bids

## SECTION 00700 - GENERAL CONDITIONS

10. Instructions to Bidders
11. General Conditions
12. Technical Specifications
13. Drawings

B. With reference to the Drawings the order of precedence is as follows:

1. Figures govern over scaled dimensions
2. Detail Drawings govern over general Drawings
3. Addenda/ Change Order drawings govern over Contract Drawings
4. Contract Drawings govern over standard drawings

3.3 AMENDING AND SUPPLEMENTING CONTRACT DOCUMENTS. The Contract Documents may be amended to provide for additions, deletions, and revisions in the WORK or to modify the terms and conditions thereof by a Change Order (pursuant to Article 10 CHANGES IN THE WORK).

3.4 REUSE OF DOCUMENTS. Neither the CONTRACTOR, nor any Subcontractor or Supplier, nor any other person or organization performing any of the WORK under a contract with the OWNER shall have or acquire any title to or ownership rights in any of the Drawings, Technical Specifications, or other documents used on the WORK, and they shall not reuse any of them on the extensions of the Project or any other project without written consent of the OWNER.

### ARTICLE 4 AVAILABILITY OF LANDS; PHYSICAL CONDITIONS; REFERENCE POINTS

4.1 AVAILABILITY OF LANDS. The OWNER shall furnish, as indicated in the Contract Documents, the lands upon which the WORK is to be performed, rights-of-way and easements for access thereto, and such other lands which are designated for the use of the CONTRACTOR. Easements for permanent structures or permanent changes in existing facilities will be obtained and paid for by the OWNER, unless otherwise provided in the Contract Documents. Nothing contained in the Contract Documents shall be interpreted as giving the CONTRACTOR exclusive occupancy of the lands or rights-of-way provided. The CONTRACTOR shall provide for all additional lands and access thereto that may be required for temporary construction facilities or storage of materials and equipment; provided, that the CONTRACTOR shall not enter upon nor use any property not under the control of the OWNER until a written temporary construction easement, lease or other appropriate agreement has been executed by the CONTRACTOR and the property owner, and a copy of said agreement furnished to the ENGINEER prior to said use; and, neither the OWNER nor the ENGINEER shall be liable for any claims or damages resulting from the CONTRACTOR's unauthorized trespass or use of any such properties.

#### 4.2 PHYSICAL CONDITIONS - SUBSURFACE AND EXISTING STRUCTURES

A. Explorations and Reports. Reference is made to SGC 4.2 Physical Conditions of the Supplementary General Conditions for identification of those reports of explorations and tests of sub-surface conditions at the site that have been utilized by the ENGINEER in the preparation of the Contract Documents. The CONTRACTOR may rely upon the accuracy of the technical data contained in such reports, however, reports are not to be considered complete or comprehensive and nontechnical data, interpretations, and opinions contained in such reports are not to be relied on by the CONTRACTOR. The CONTRACTOR is

## SECTION 00700 - GENERAL CONDITIONS

responsible for any further explorations or tests that may be necessary and any interpretation, interpolation, or extrapolation that it makes of any information shown in such reports.

- B. Existing Structures. Reference is made to SGC 4.2 Physical Conditions of the Supplementary General Conditions for identification of those drawings of physical conditions in or relating to existing surface and subsurface structures (except Underground Utilities referred to in Paragraph 4.4 herein) which are at or contiguous to the site that have been utilized by the ENGINEER in the preparation of the Contract Documents. The CONTRACTOR may rely upon the accuracy of the technical data contained in such drawings, however, nontechnical data, interpretations, and opinions contained in such drawings are not to be relied on by the CONTRACTOR. The CONTRACTOR is also responsible for any interpretation, interpolation, or extrapolation that it makes of any information shown in such drawings.

### 4.3 DIFFERING SITE CONDITIONS

- A. The CONTRACTOR shall promptly upon discovery (but in no event later than 14 days thereafter) and before the following conditions are disturbed, notify the ENGINEER, in writing of any:
  - 1. Material that the CONTRACTOR believes may be material that is hazardous waste, as defined in Article 1 of these General Conditions, or asbestos, PCB's, petroleum or any other substance or material posing a threat to human or to the environment.
  - 2. Subsurface or latent physical conditions at the site differing from those indicated.
  - 3. Unknown physical conditions at the site of any unusual nature, different materially from those ordinarily encountered and generally recognized as inherent in WORK of the character provided for in the contract.
- B. The OWNER shall promptly investigate the conditions, and if it finds that the conditions do materially so differ, or do involve hazardous waste, and cause a decrease or increase in the CONTRACTOR's cost of, or the time required for, performance of any part of the WORK shall issue a Change Order under the procedures described in the contract.
- C. In the event that a dispute arises between the OWNER and the CONTRACTOR whether the conditions materially differ, or involved hazardous waste or other materials listed above, or cause a decrease or increase in the CONTRACTOR's cost of, or time required for, performance of any part of the WORK, the CONTRACTOR shall not be excused from any scheduled completion date provided for by the contract, but shall proceed with all WORK to be performed under the contract. The CONTRACTOR shall retain any and all rights provided either by contract or by Law which pertain to the resolution of disputes and protests between the contracting parties.

### 4.4 PHYSICAL CONDITIONS - UNDERGROUND UTILITIES

- A. Indicated. The information and data indicated in the Contract Documents with respect to existing Underground Utilities at or contiguous to the site are based on information and data furnished to the OWNER or the ENGINEER by the owners of such Underground Utilities or by others. Unless it is expressly provided in the Supplementary General Conditions and/or Section 01530 - Protection and Restoration of Existing Facilities of the General Requirements, the OWNER and the ENGINEER shall not be responsible for the accuracy or

## SECTION 00700 - GENERAL CONDITIONS

completeness of any such information or data, and the CONTRACTOR shall have full responsibility for reviewing and checking all such information and data, for locating all Underground Utilities indicated in the Contract Documents, for coordination of the WORK with the owners of such Underground Utilities during construction, for the safety and protection thereof and repairing any damage thereto resulting from the WORK, the cost of which will be considered as having been included in the Contract Price.

- B. Not Indicated. If an Underground Utility is uncovered or revealed at or contiguous to the site which was not indicated in the Contract Documents and which the CONTRACTOR could not reasonably have been expected to be aware of, the CONTRACTOR shall identify the owner of such Underground Utility and give written notice thereof to that owner and shall notify the ENGINEER in accordance with the requirements of the Supplementary General Conditions and Section 01530 - Protection and Restoration of Existing Facilities of the General Requirements.

### 4.5 REFERENCE POINTS

- A. The ENGINEER will provide one bench mark, near or on the site of the WORK, and will provide two points near or on the site to establish a base line for use by the CONTRACTOR for alignment control. Unless otherwise specified in the General Requirements, the CONTRACTOR shall furnish all other lines, grades, and bench marks required for proper execution of the WORK.
- B. The CONTRACTOR shall preserve all bench marks, stakes, and other survey marks, and in case of their removal or destruction by its own employees or by its Subcontractor's employees, the CONTRACTOR shall be responsible for the accurate replacement of such reference points by personnel qualified under the Alaska Statute governing the licensing of Architects, Engineers, and Land Surveyors.

### 4.6 USE OF THE CBJ/STATE LEMON CREEK GRAVEL PIT

- A. On City and Borough of Juneau (CBJ) construction projects, the CBJ may make unclassified material available to CONTRACTORS, from the CBJ/State Lemon Creek gravel pit, at a rate less than charged other customers. CONTRACTORS are not required to use material from the CBJ/State pit and the CBJ makes no guarantee as to the quantity or quality of the available material. For this Project, contact Alec Venechuk, CBJ Material Source Manager, at (907) 586-0874 for the current material rates.
- B. CONTRACTORS proposing to use gravel from the CBJ/State pit are required to be in good standing for all amounts owed to the CBJ, for previous gravel operations, prior to submitting a mining plan for approval. CONTRACTORS using the pit must comply with Allowable Use Permit USE 2008-00061. Failure to meet these requirements, if so subject, shall be sufficient reason to deny use of the CBJ/State pit as a gravel source. To determine if your company is subject to these requirements, contact the CBJ Engineering Department, Gravel Pit Management, at (907) 586-0874.
- C. CONTRACTORS deciding to use material from the CBJ/State pit shall provide an Individual Mining Plan prepared by a professional engineer registered in the State of Alaska. The Individual Mining Plan must be reviewed and approved by the CBJ, prior to commencing



## SECTION 00700 - GENERAL CONDITIONS

operations within the pit. CONTRACTORS shall also secure a Performance Bond to ensure compliance with contract provisions, including any Individual Mining Plan stipulations. The bond shall remain in full force and effect until a release is obtained from the CBJ.

- D. If CONTRACTOR operations for a project do not exceed 500 tons of material, the CONTRACTOR will not be required to provide an Individual Mining Plan prepared by an engineer. However, the CONTRACTOR must submit an Individual Mining Plan that is in compliance with Allowable Use Permit USE 2008-00061 for gravel extraction within the CBJ/State pit. The CONTRACTOR must contact the CBJ Engineering Department for conditions for the extraction.
- E. CONTRACTORS using the CBJ material may do primary dry separation (screening) of materials within the pit. Crushing and washing of material will not be allowed. CONTRACTORS shall account for placement of materials removed from the pit. The CBJ may require CONTRACTORS to cross-check weight tickets, submit to an audit, or participate in other measures required by the CBJ to ensure accountability. Unprocessed overburden removed from the pit will not be weighed. All other material mined will be weighed at the CBJ scale. CONTRACTORS will be responsible for loading and/or screening their own material. If asphalt pavement is removed as part of the WORK, CONTRACTORS shall dispose of the material at a to-be-specified location within the pit area, as directed by the CBJ Project Manager.
- F. The gravel pit overhead charge shall be paid to the CBJ by the CONTRACTOR within 60 days after removal of all materials from the pit and prior to requesting and/or receiving final payment. Upon completion of each excavation CONTRACTORS shall notify the CBJ, in writing, in sufficient time to perform a field-compliance examination prior to vacating the pit. Any significant deviation from the stipulations of the Individual Mining Plan identified during the field inspection shall be corrected by the CONTRACTOR prior to release of the bond. A signed release from CBJ will be required prior to releasing the CONTRACTOR's bond.
- G. If asphalt pavement is removed as part of this WORK, the CONTRACTOR shall dispose of the material at the location designated as the Asphalt Storage Facility, or as directed by the ENGINEER.
- H. The CBJ/State pit is a seasonal operation. The hours of operation are from 7:00 a.m. to 6:00 p.m., Monday through Friday, from April 1 through October 15 of the year. CONTRACTORS may obtain gravel on weekends, or during the off-season, by applying for a separate agreement with the City and Borough of Juneau Engineering Department. The CONTRACTOR will be responsible for any additional costs incurred during weekend or off-season operations at the gravel pit.
- I. All Contractors/Equipment Operators using the CBJ/State Pit shall be in compliance with Federal Mine Safety and Health Administration regulations for quarry and gravel operations.

## ARTICLE 5 BONDS AND INSURANCE

### 5.1 PERFORMANCE, PAYMENT, AND OTHER BONDS

## SECTION 00700 - GENERAL CONDITIONS

- A. The CONTRACTOR shall furnish, when required, Performance and Payment Bonds on forms provided by the CBJ for the penal sums of 100% of the amount of the Bid award. The surety on each bond may be any corporation or partnership authorized to do business in the State of Alaska as an insurer under AS 21.09. These bonds shall remain in effect for 12 months after the date of final payment and until all obligations and liens under this contract have been satisfied. The CONTRACTOR shall also furnish such other Bonds as are required by the Supplementary General Conditions. All Bonds shall be in the form prescribed by the Contract Documents except as provided otherwise by Laws or Regulations, and shall be executed by such sureties as are named in the current list of "Companies Holding Certificates of Authority as Acceptable Sureties on Federal Bonds and as Acceptable Reinsuring Companies" as published in Circular 570 (amended) by the Audit Staff, Bureau of Government Financial Operations, U.S. Treasury Department. All Bonds signed by an agent must be accompanied by a certified copy of such agent's authority to act.
- B. If the surety on any Bond furnished by the CONTRACTOR is declared bankrupt or becomes insolvent or its right to do business is terminated in any state where any part of the WORK is located, the CONTRACTOR shall within 7 days thereafter substitute another Bond and Surety, which must be acceptable to the OWNER.
- C. All Bonds required by the Contract Documents to be purchased and maintained by CONTRACTOR shall be obtained from surety companies that are duly licensed or authorized in the State of Alaska to issue Bonds for the limits so required. Such surety companies shall also meet such additional requirements and qualifications as may be provided in the Supplementary General Conditions. The City Engineer may, on behalf of the OWNER, notify the surety of any potential default or liability.

### 5.2 INSURANCE

- A. The CONTRACTOR shall purchase and maintain the insurance required under this paragraph. Such insurance shall include the specific coverages set out herein and be written for not less than the limits of liability and coverages provided in the Supplementary General Conditions, or required by law, whichever are greater. All insurance shall be maintained continuously during the life of the Agreement up to the date of Final Completion and at all times thereafter when the CONTRACTOR may be correcting, removing, or replacing Defective WORK in accordance with Paragraph 13.6, but the CONTRACTOR's liabilities under this Agreement shall not be deemed limited in any way to the insurance coverage required.
- B. All insurance required by the Contract Documents to be purchased and maintained by the CONTRACTOR shall be obtained from insurance companies that are duly licensed or authorized in the State of Alaska to issue insurance policies for the limits and coverages so required. Such insurance companies shall have a current Best's Rating of at least an "A" (Excellent) general policy holder's rating and a Class VII financial size category and shall also meet such additional requirements and qualifications as may be provided in the Supplementary General Conditions.
- C. The CONTRACTOR shall furnish the OWNER with certificates showing the type, amount, class of operations covered, effective dates and dates of expiration of policies. All of the policies of insurance so required to be purchased and maintained (or the certificates or other

## SECTION 00700 - GENERAL CONDITIONS

evidence thereof) shall contain a provision or endorsement that the coverage afforded will not be cancelled, reduced in coverage, or renewal refused until at least 30 days' prior written notice has been given to the OWNER by certified mail. All such insurance required herein (except for Workers' Compensation and Employer's Liability) shall name the OWNER, its Consultants and subconsultants and their officers, directors, agents, and employees as "additional insureds" under the policies. The CONTRACTOR shall purchase and maintain the following insurance:

1. Workers' Compensation and Employer's Liability. This insurance shall protect the CONTRACTOR against all claims under applicable state workers' compensation laws. The CONTRACTOR shall also be protected against claims for injury, disease, or death of employees which, for any reason, may not fall within the provisions of a Workers' Compensation law. This policy shall include an "all states" endorsement. The CONTRACTOR shall require each Subcontractor similarly to provide Workers' Compensation Insurance for all of the latter's employees to be engaged in such WORK unless such employees are covered by the protection afforded by the CONTRACTOR's Workers' Compensation Insurance. In case any class of employees is not protected, under the Workers' Compensation Statute, the CONTRACTOR shall provide and shall cause each Subcontractor to provide adequate employer's liability insurance for the protection of such of its employees as are not otherwise protected.
2. Commercial General Liability. This insurance shall be written in comprehensive form and shall protect the CONTRACTOR against all claims arising from injuries to persons other than its employees or damage to property of the OWNER or others arising out of any act or omission of the CONTRACTOR or its agents, employees, or Subcontractors. The policy shall contain no exclusions for any operations within the scope of this contract.
3. Comprehensive Automobile Liability. This insurance shall be written in comprehensive form and shall protect the CONTRACTOR against all claims for injuries to members of the public and damage to property of others arising from the use of motor vehicles, and shall cover operation on or off the site of all motor vehicles licensed for highway use, whether they are owned, non-owned, or hired. Coverage for hired motor vehicles should include endorsement covering liability assumed under this Agreement.
4. Subcontractor's Commercial General Liability Insurance and Commercial Automobile Liability Insurance. The CONTRACTOR shall either require each of its Subcontractors to procure and to maintain Subcontractor's Commercial General Liability and Property Damage Insurance and Vehicle Liability Insurance of the type and in the amounts specified in the Supplementary General Conditions or insure the activities of its Subcontractors in the CONTRACTOR's own policy, in like amount.
5. Builder's Risk. This insurance shall be of the "all risks" type, shall be written in completed value form, and shall protect the CONTRACTOR, the OWNER, and the ENGINEER, against risks of damage to buildings, structures, and materials and equipment. The amount of such insurance shall be not less than the insurable value of the WORK at completion. Builder's risk insurance shall provide for losses to be payable to the CONTRACTOR and the OWNER, as their interests may appear. The policy shall contain a provision that in the event of payment for any loss under the coverage provided, the insurance company shall have no rights of recovery against the

## **SECTION 00700 - GENERAL CONDITIONS**

CONTRACTOR, the OWNER, and the ENGINEER. The Builder's Risk policy shall insure against all risks of direct physical loss or damage to property from any external cause including flood and earthquake. Allowable exclusions, if any, shall be as specified in the Supplementary General Conditions.

### **ARTICLE 6 CONTRACTOR'S RESPONSIBILITIES**

#### **6.1 SUPERVISION AND SUPERINTENDENCE**

- A. The CONTRACTOR shall supervise, inspect, and direct the WORK competently and efficiently, devoting such attention thereto and applying such skills and expertise as may be necessary to perform the WORK in accordance with the Contract Documents. The CONTRACTOR shall be solely responsible for the means, methods, techniques, sequences, and procedures of construction and safety precautions and programs incidental thereto. The CONTRACTOR shall be responsible to see that the completed WORK complies accurately with the Contract Documents.
- B. The CONTRACTOR shall designate in writing and keep on the WORK site at all times during its progress a technically qualified, English-speaking superintendent, who is an employee of the CONTRACTOR and who shall not be replaced without written notice to the OWNER and the ENGINEER. The superintendent will be the CONTRACTOR's representative at the site and shall have authority to act on behalf of the CONTRACTOR. All communications given to the superintendent shall be as binding as if given to the CONTRACTOR. The CONTRACTOR shall issue all its communications to the OWNER through the ENGINEER and the ENGINEER only.
- C. The CONTRACTOR's superintendent shall be present at the site of the WORK at all times while WORK is in progress. Failure to observe this requirement shall be considered suspension of the WORK by the CONTRACTOR until such time as such superintendent is again present at the site.

#### **6.2 LABOR, MATERIALS, AND EQUIPMENT**

- A. The CONTRACTOR shall provide competent, suitably qualified personnel to survey and lay out the WORK and perform construction as required by the Contract Documents. The CONTRACTOR shall furnish, erect, maintain, and remove the construction plant and any temporary works as may be required. The CONTRACTOR shall at all times maintain good discipline and order at the site. Except in connection with the safety or protection of persons or the WORK or property at the site or adjacent thereto, and except as otherwise indicated in the Contract Documents, all WORK at the site shall be performed during regular working hours, and the CONTRACTOR will not permit overtime work or the performance of work on Saturday, Sunday, or any legal holiday without the OWNER's written consent. The CONTRACTOR shall apply for this consent through the ENGINEER.
- B. Except as otherwise provided in this Paragraph, the CONTRACTOR shall receive no additional compensation for overtime work, i.e., work in excess of 8 hours in any one calendar day or 40 hours in any one calendar week, even though such overtime work may be required under emergency conditions and may be ordered by the ENGINEER in writing. Additional compensation will be paid the CONTRACTOR for overtime work only in the

## SECTION 00700 - GENERAL CONDITIONS

event extra work is ordered by the ENGINEER and the Change Order specifically authorizes the use of overtime work and then only to such extent as overtime wages are regularly being paid by the CONTRACTOR for overtime work of a similar nature in the same locality.

- C. All costs of inspection and testing performed during overtime work by the CONTRACTOR which is allowed solely for the convenience of the CONTRACTOR shall be borne by the CONTRACTOR. The OWNER shall have the authority to deduct the cost of all such inspection and testing from any partial payments otherwise due to the CONTRACTOR.
  - D. Unless otherwise specified in the Contract Documents, the CONTRACTOR shall furnish and assume full responsibility for all materials, equipment, labor, transportation, construction equipment and machinery, tools, appliances, fuel, power, light, heat, telephone, water, sanitary facilities, and all other facilities and incidentals necessary for the furnishing, performance, testing, start-up, and completion of the WORK.
  - E. All materials and equipment to be incorporated into the WORK shall be of good quality and new, except as otherwise provided in the Contract Documents. All warranties and guarantees specifically called for by the Specifications shall expressly run to the benefit of the OWNER. If required by the ENGINEER, the CONTRACTOR shall furnish satisfactory evidence (including reports of required tests) as to the kind and quality of materials and equipment. All materials and equipment shall be applied, installed, connected, erected, used, cleaned, and conditioned in accordance with the instructions of the applicable Supplier except as otherwise provided in the Contract Documents; but no provisions of any such instructions will be effective to assign to the ENGINEER, or any of the ENGINEER consultants, agents, or employees, any duty or authority to supervise or direct the furnishing or performance of the WORK or any duty or authority to undertake responsibility contrary to the provisions of Paragraphs 9.9C and 9.9D.
  - F. The CONTRACTOR shall at all times employ sufficient labor and equipment for prosecuting the several classes of WORK to full completion in the manner and time set forth in and required by these specifications. All workers shall have sufficient skill and experience to perform properly the WORK assigned to them. Workers engaged in special WORK, or skilled WORK, shall have sufficient experience in such WORK and in the operation of the equipment required to perform all WORK, properly and satisfactorily.
  - G. Any person employed by the CONTRACTOR or by any Subcontractor who, in the opinion of the ENGINEER, does not perform the WORK in a proper and skillful manner, or is intemperate or disorderly shall, at the written request of the ENGINEER, be removed forthwith by the CONTRACTOR or Subcontractor employing such person, and shall not be employed again in any portion of the WORK without the approval of the ENGINEER. Should the CONTRACTOR fail to remove such person or persons as required above, or fail to furnish suitable and sufficient personnel for the proper prosecution of the WORK, the ENGINEER may suspend the WORK by written notice until such orders are complied with.
- 6.3 ADJUSTING PROGRESS SCHEDULE. The CONTRACTOR shall submit monthly updates of the progress schedule to the ENGINEER for acceptance in accordance with the provisions in Section 01300 - CONTRACTOR Submittals in the General Requirements.

## SECTION 00700 - GENERAL CONDITIONS

- 6.4 SUBSTITUTES OR "OR-EQUAL" ITEMS. The CONTRACTOR shall submit proposed substitutes or "or-equal" items in accordance with the provisions in Section 01300 - CONTRACTOR Submittals in the General Requirements.
- 6.5 CONCERNING SUBCONTRACTORS, SUPPLIERS, AND OTHERS.
- A. The CONTRACTOR shall be responsible to the OWNER and the ENGINEER for the acts and omissions of its Subcontractors and their employees to the same extent as CONTRACTOR is responsible for the acts and omissions of its own employees. Nothing contained in this Paragraph shall create any contractual relationship between any Subcontractor and the OWNER or the ENGINEER nor relieve the CONTRACTOR of any liability or obligation under the prime contract.
- B. The CONTRACTOR shall perform not less than 40% of the WORK with its own forces (i.e., without subcontracting). The 40% requirement shall be understood to mean that the CONTRACTOR shall perform, with its own organization, WORK amounting to at least 40% of the awarded contract amount. The 40% requirement will be calculated based upon the total of the subcontract amounts submitted for contract award, and any other information requested by the OWNER from the apparent low bidder.
- 6.6 PERMITS
- A. Unless otherwise provided in the Supplementary General Conditions, the CONTRACTOR shall obtain and pay for all construction permits and licenses from the agencies having jurisdiction, including the furnishing of insurance and bonds if required by such agencies. The enforcement of such requirements under this contract shall not be made the basis for claims for additional compensation. The OWNER shall assist the CONTRACTOR, when necessary, in obtaining such permits and licenses. The CONTRACTOR shall pay all governmental charges and inspection fees necessary for the prosecution of the WORK, which are applicable at the time of opening of Bids. The CONTRACTOR shall pay all charges of utility owners for connections to the WORK.
- B. These Contract Documents may require that the WORK be performed within the conditions and/or requirements of local, state and/or federal permits. These permits may be bound within the Contract Documents, included within the Contract Documents by reference, or included as part of the WORK, as designated in this Section. The CONTRACTOR is responsible for completing the WORK required for compliance with all permit requirements; this WORK is incidental to other items in the Contract Documents. Any reference to the PERMITTEE in the permits shall mean the CONTRACTOR. If any permits were acquired by the OWNER, this action was done to expedite the start of construction. If the CONTRACTOR does not complete the WORK within the specified permit window, the CONTRACTOR shall be responsible for the permit extension, and for completing any additional requirements placed upon the permit.
- C. The OWNER shall apply for, and obtain, the necessary building permit for this Project, however, the CONTRACTOR is responsible for scheduling and coordinating all necessary inspections. The CBJ Inspection number is 586-1703. All other provisions of this Section remain in effect.

## SECTION 00700 - GENERAL CONDITIONS

- 6.7 **PATENT FEES AND ROYALTIES.** The CONTRACTOR shall pay all license fees and royalties and assume all costs incident to the use in the performance of the WORK or the incorporation in the WORK of any invention, design, process, product, software or device which is the subject of patent rights or copyrights held by others. If a particular invention, design, process, product, or device is specified in the Contract Documents for use in the performance of the WORK and if to the actual knowledge of the OWNER or the ENGINEER its use is subject to patent rights or copyrights calling for the payment of any license fee or royalty to others, the existence of such rights shall be disclosed by the OWNER in the Contract Documents. The CONTRACTOR shall indemnify, defend and hold harmless the OWNER and the ENGINEER and anyone directly or indirectly employed by either of them from and against all claims, damages, losses, and expenses (including attorneys' fees and court costs) arising out of any infringement of patent rights or copyrights incident to the use in the performance of the WORK or resulting from the incorporation in the WORK of any invention, design, process, product, or device not specified in the Contract Documents, and shall defend all such claims in connection with any alleged infringement of such rights.
- 6.8 **LAWS AND REGULATIONS.** The CONTRACTOR shall observe and comply with all federal, state, and local laws, ordinances, codes, orders, and regulations which in any manner affect those engaged or employed on the WORK, the materials used in the WORK, or the conduct of the WORK. If any discrepancy or inconsistency should be discovered in this contract in relation to any such law, ordinance, code, order, or regulation, the CONTRACTOR shall report the same in writing to the ENGINEER. The CONTRACTOR shall indemnify, defend, and hold harmless the OWNER, the ENGINEER, and their officers, agents, and employees against all claims or liability arising from violation of any such law, ordinance, code, order, or regulation, whether by CONTRACTOR or by its employees, Subcontractors, or third parties. Any particular law or regulation specified or referred to elsewhere in the Contract Documents shall not in any way limit the obligation of the CONTRACTOR to comply with all other provisions of federal, state, and local laws and regulations. The OWNER may, per AS 36.30, audit the CONTRACTOR's or Subcontractor(s) records that are related to the cost or pricing data for this contract, all related Change Orders, and/or contract modifications.
- 6.9 **TAXES.** The CONTRACTOR shall pay all sales, consumer, use, and other similar taxes required to be paid by the CONTRACTOR in accordance with the Laws and Regulations of the place of the Project which are applicable during the performance of the WORK.
- 6.10 **USE OF PREMISES.** The CONTRACTOR shall confine construction equipment, the storage of materials and equipment, and the operations of workers to (1) the Project site, (2) the land and areas identified in and permitted by the Contract Documents, and (3) the other land and areas permitted by Laws and Regulations, rights-of-way, permits, leases and easements. The CONTRACTOR shall assume full responsibility for any damage to any such land or area, or to the owner or occupant thereof or of any land or areas contiguous thereto, resulting from the performance of the WORK. Should any claim be made against the OWNER or the ENGINEER by any such owner or occupant because of the performance of the WORK, the CONTRACTOR shall promptly attempt to settle with such other party by agreement or otherwise resolve the claim through litigation. The CONTRACTOR shall, to the fullest extent permitted by Laws and Regulations, indemnify, defend, and hold the OWNER and the ENGINEER harmless from and against all claims, damages, losses, and expenses (including, but not limited to, fees of engineers attorneys, and other professionals and court costs) arising directly, indirectly, or consequentially out of any action, legal or equitable, brought by any such owner or occupant against the OWNER, the ENGINEER, their Consultants, Sub-consultants, and the officers,

## SECTION 00700 - GENERAL CONDITIONS

directors, employees and agents of each and any of them to the extent caused by or based upon the CONTRACTOR's performance of the WORK.

### 6.11 SAFETY AND PROTECTION

- A. The CONTRACTOR shall be responsible for initiating, maintaining, and supervising all safety precautions and programs in connection with the WORK. The CONTRACTOR shall take all necessary precautions for the safety of, and shall provide the necessary protection to prevent damage, injury or loss to:
1. all employees on the WORK and other persons and organizations who may be affected thereby;
  2. all the WORK and materials and equipment to be incorporated therein, whether in storage on or off the site; and
  3. other property at the site or adjacent thereto, including trees, shrubs, lawns, walks, pavements, roadways, structures, and utilities not designated for removal, relocation, or replacement in the course of construction.
- B. The CONTRACTOR shall comply with all applicable Laws and Regulations whether referred to herein or not) of any public body having jurisdiction for the safety of persons or property or to protect them from damage, injury, or loss and shall erect and maintain all necessary safeguards for such safety and protection. The CONTRACTOR shall notify owners of adjacent property and utilities when prosecution of the WORK may affect them, and shall cooperate with them in the protection, removal, relocation, and replacement of their property.
- C. The CONTRACTOR shall designate a qualified and experienced safety representative at the site whose duties and responsibilities shall be the prevention of accidents and the maintaining and supervising of safety precautions and program.
- D. Materials that contain hazardous substances or mixtures may be required on the WORK. A Material Safety Data Sheet shall be requested by the CONTRACTOR from the manufacturer of any hazardous product used.
- E. Material usage shall be accomplished with strict adherence to all safety requirements and all manufacturer's warnings and application instructions listed on the Material Safety Data Sheet and on the product container label.
- F. The CONTRACTOR shall be responsible for coordinating communications on any exchange of Material Safety Data Sheets or other hazardous material information that is required to be made available to, or exchanged between, or among, employers at the site in accordance with Laws or Regulations.
- G. The CONTRACTOR shall notify the ENGINEER if it considers a specified product or its intended usage to be unsafe. This notification must be given to the ENGINEER prior to the product being ordered, or if provided by some other party, prior to the product being incorporated in the WORK.



## SECTION 00700 - GENERAL CONDITIONS

### 6.12 SHOP DRAWINGS AND SAMPLES

- A. After checking and verifying all field measurements and after complying with applicable procedures specified in the General Requirements, the CONTRACTOR shall submit to the ENGINEER for review, all Shop Drawings in accordance with Section 01300 - CONTRACTOR Submittals in the General Requirements.
- B. The CONTRACTOR shall also submit to the ENGINEER for review all samples in accordance with Section 01300 - CONTRACTOR Submittals in the General Requirements.
- C. Before submittal of each shop drawing or sample, the CONTRACTOR shall have determined and verified all quantities, dimensions, specified performance criteria, installation requirements, materials, catalog numbers, and similar data with respect thereto and reviewed or coordinated each Shop Drawing or sample with other Shop Drawings and samples and with the requirements of the WORK and the Contract Documents.

6.13 CONTINUING THE WORK. The CONTRACTOR shall carry on the WORK and adhere to the progress schedule during all disputes or disagreements with the OWNER. No work shall be delayed or postponed pending resolution of any disputes or disagreements, except as the CONTRACTOR and the OWNER may otherwise agree in writing.

### 6.14 INDEMNIFICATION

- A. To the fullest extent permitted by Laws and Regulations, the CONTRACTOR shall indemnify, defend, and hold harmless the OWNER, the ENGINEER, their Consultants, Sub-consultants and the officers, directors, employees, and agents of each and any of them, against and from all claims and liability arising under, by reason of or incidentally to the contract or any performance of the WORK, but not from the sole negligence or willful misconduct of the OWNER, and the ENGINEER. Such indemnification by the CONTRACTOR shall include but not be limited to the following:
  - 1. Liability or claims resulting directly or indirectly from the negligence or carelessness of the CONTRACTOR, its employees, or agents in the performance of the WORK, or in guarding or maintaining the same, or from any improper materials, implements, or appliances used in its construction, or by or on account of any act or omission of the CONTRACTOR, its employees, agents, or third parties;
  - 2. Liability or claims arising directly or indirectly from bodily injury, occupational sickness or disease, or death of the CONTRACTOR's or Subcontractor's own employees engaged in the WORK resulting in actions brought by or on behalf of such employees against the OWNER, and the ENGINEER;
  - 3. Liability or claims arising directly or indirectly from or based on the violation of any law, ordinance, regulation, order, or decree, whether by the CONTRACTOR, its employees, or agents;
  - 4. Liability or claims arising directly or indirectly from the use or manufacture by the CONTRACTOR, its employees, or agents in the performance of this contract of any copyrighted or non-copyrighted composition, secret process, patented or non-patented invention, computer software, article, or appliance, unless otherwise specifically stipulated in this contract.

## SECTION 00700 - GENERAL CONDITIONS

5. Liability or claims arising directly or indirectly from the breach of any warranties, whether express or implied, made to the OWNER or any other parties by the CONTRACTOR, its employees, or agents;
  6. Liabilities or claims arising directly or indirectly from the willful or criminal misconduct of the CONTRACTOR, its employees, or agents; and,
  7. Liabilities or claims arising directly or indirectly from any breach of the obligations assumed herein by the CONTRACTOR.
- B. The CONTRACTOR shall reimburse the ENGINEER and the OWNER for all costs and expenses, (including but not limited to fees and charges of engineers, attorneys, and other professionals and court costs including all costs of appeals) incurred by said OWNER, and the ENGINEER in enforcing the provisions of this Paragraph 6.14.
- C. The indemnification obligation under this Paragraph 6.14 shall not be limited in any way by any limitation of the amount or type of damages, compensation, or benefits payable by or for the CONTRACTOR or any such Subcontractor or other person or organization under workers' compensation acts, disability benefit acts, or other employee benefit acts.
- 6.15 **CONTRACTOR'S DAILY REPORTS.** The CONTRACTOR shall complete a daily report indicating total manpower for each construction trade, major equipment on site, each Subcontractor's manpower, weather conditions, etc., involved in the performance of the WORK. The daily report shall be completed on forms provided by the ENGINEER and shall be submitted to the ENGINEER at the conclusion of each workday. The report should comment on the daily progress and status of the WORK within each major component of the WORK. These components will be decided by the ENGINEER. CONTRACTOR shall record the name, affiliation, time of arrival and departure, and reason for visit for all visitors to the location of the WORK.
- 6.16 **ASSIGNMENT OF CONTRACT.** The CONTRACTOR shall not assign, sublet, sell, transfer, or otherwise dispose of the contract or any portion thereof, or its right, title, or interest therein, or obligations thereunder, without the written consent of the OWNER except as imposed by law. If the CONTRACTOR violates this provision, the contract may be terminated at the option of the OWNER. In such event, the OWNER shall be relieved of all liability and obligations to the CONTRACTOR and to its assignee or transferee, growing out of such termination.
- 6.17 **CONTRACTOR'S RESPONSIBILITY FOR UTILITY PROPERTY AND SERVICES.** It is understood that any turn-on or turn-off, line locates and any other work or assistance necessary by the CBJ Water Utilities Division, will be at the CONTRACTOR's expense unless otherwise stated in the bid documents. All cost must be agreed to prior to any related actions, and will be considered incidental to the project cost. Billing to the CONTRACTOR will be direct from the CBJ Water Utilities Division.
- 6.18 **OPERATING WATER SYSTEM VALVES**
- A. The CONTRACTOR shall submit a written request, to the ENGINEER, for approval to operate any valve on any in-service section of the CBJ water system. The request must be submitted at least 24-hours prior to operating any valves. The CBJ Water Utilities Division reserves the right to approve or deny the request. The request shall specifically identify each valve to be operated, the time of operation, and the operation to be performed. The

## SECTION 00700 - GENERAL CONDITIONS

CONTRACTOR shall obtain the written approval of the ENGINEER for any scheduled operation before operating any valve.

- B. The CONTRACTOR shall be responsible for all damages, both direct and consequential, to the City or any other party, caused by unauthorized operation of any valve of the CBJ water system.

6.19 CONTRACTOR'S WORK SCHEDULE LIMITATIONS. Construction of Buildings and Projects. It is unlawful to operate any pile driver, power shovel, pneumatic hammer, derrick, power hoist, or similar heavy construction equipment before 7:00 a.m. or after 10:00 p.m., Monday through Friday, or before 9:00 a.m. or after 10:00 p.m., Saturday and Sunday, unless a permit shall first be obtained from the City and Borough Building Official. Such permit shall be issued by the Building Official only upon a determination that such operation during hours not otherwise permitted hereunder is necessary and will not result in unreasonable disturbance to surrounding residents.

### ARTICLE 7 OTHER WORK

#### 7.1 RELATED WORK AT SITE

- A. The OWNER may perform other work related to the Project at the site by the OWNER's own forces, have other work performed by utility owners, or let other direct contracts therefor which may contain General Conditions similar to these. If the fact that such other work is to be performed was not noted in the Contract Documents, written notice thereof will be given to the CONTRACTOR prior to starting any such other work.
- B. The CONTRACTOR shall afford each other contractor who is a party to such a direct contract and each utility owner (or the OWNER, if the OWNER is performing the additional work with the OWNER's employees) proper and safe access to the site and a reasonable opportunity for the introduction and storage of materials and equipment and the execution of such work, and shall properly connect and coordinate the WORK with theirs. The CONTRACTOR shall do all cutting, fitting, and patching of the WORK that may be required to make its several parts come together properly and integrate with such other work. The CONTRACTOR shall not endanger any work of others by cutting, excavating, or otherwise altering their work and will only cut or alter their work with the written consent of the ENGINEER and the others whose work will be affected.
- C. If the proper execution or results of any part of the CONTRACTOR's work depends upon the work of any such other contractor or utility owner (or OWNER), the CONTRACTOR shall inspect and report to the ENGINEER in writing any delays, defects, or deficiencies in such other work that render it unavailable or unsuitable for such proper execution and results. The CONTRACTOR's failure to report such delays, defects, or deficiencies will constitute an acceptance of the other work as fit and proper for integration with the CONTRACTOR's work except for latent or nonapparent defects and deficiencies in the other work.

7.2 COORDINATION. If the OWNER contracts with others for the performance of other work on the Project at the site, the person or organization who will have authority and responsibility for coordination of the activities among the various prime contractors will be identified in the Supplementary General Conditions, and the specific matters to be covered by such authority and

## SECTION 00700 - GENERAL CONDITIONS

responsibility will be itemized and the extent of such authority and responsibilities will be provided in the Supplementary General Conditions.

### ARTICLE 8 OWNER'S RESPONSIBILITIES

#### 8.1 COMMUNICATIONS

- A. The OWNER shall issue all its communications to the CONTRACTOR through the ENGINEER.
- B. The CONTRACTOR shall issue all its communications to the OWNER through the ENGINEER.

8.2 PAYMENTS. The OWNER shall make payments to the CONTRACTOR as provided in Paragraphs 14.5, 14.8, 14.9 and 14.10.

8.3 LANDS, EASEMENTS, AND SURVEYS. The OWNER's duties in respect of providing lands and easements and providing surveys to establish reference points are set forth in Paragraphs 4.1 and 4.5.

8.4 CHANGE ORDERS. The OWNER shall execute Change Orders as indicated in Paragraph 10.1F.

8.5 INSPECTIONS AND TESTS. The OWNER's responsibility in respect of inspections, tests, and approvals is set forth in Paragraph 13.3.

8.6 SUSPENSION OF WORK. In connection with the OWNER's right to stop WORK or suspend WORK, see Paragraphs 13.4 and 15.1.

8.7 TERMINATION OF AGREEMENT. Paragraphs 15.2 and 15.3 deal with the OWNER's right to terminate services of the CONTRACTOR.

### ARTICLE 9 ENGINEER'S STATUS DURING CONSTRUCTION

9.1 OWNER'S REPRESENTATIVE. The ENGINEER will be the OWNER's representative during the construction period. The duties and responsibilities and the limitations of authority of the ENGINEER as the OWNER's representative during construction are set forth in the Contract Documents.

9.2 VISITS TO SITE. The ENGINEER will make visits to the site during construction to observe the progress and quality of the WORK and to determine, in general, if the WORK is proceeding in accordance with the Contract Documents. Exhaustive or continuous on-site inspections to check the quality or quantity of the WORK will not be required of the ENGINEER. The ENGINEER will not, during such visits, or as a result of such observations of the CONTRACTOR's WORK in progress, supervise, direct, or have control over the CONTRACTOR's WORK.

9.3 PROJECT REPRESENTATION. The ENGINEER may furnish an Inspector to assist in observing the performance of the WORK. The duties, responsibilities, and limitations of authority are as follows:

- A. Duties, Responsibilities and Limitations of Authority of Inspector

## SECTION 00700 - GENERAL CONDITIONS

General. The Inspector, who is the ENGINEER's Agent, will act as directed by and under the supervision of the ENGINEER and will confer with the ENGINEER regarding its actions. The Inspector's dealings in matters pertaining to the on-site WORK shall, in general, be only with the ENGINEER and the CONTRACTOR, and dealings with Subcontractors shall only be through or with the full knowledge of the CONTRACTOR. Written communication with the OWNER will be only through or as directed by the ENGINEER.

Duties and Responsibilities. The Inspector may:

1. Review the progress schedule, list of Shop Drawing submittals and schedule of values prepared by the CONTRACTOR and consult with the ENGINEER concerning their acceptability.
2. Attend pre-construction conferences. Arrange a schedule of progress meetings and other job conferences as required in consultation with the ENGINEER and notify those expected to attend in advance. Attend meetings and maintain and circulate copies of minutes thereof.
3. Serve as the ENGINEER's liaison with the CONTRACTOR, working principally through the CONTRACTOR's superintendent and assist said superintendent in understanding the intent of the Contract Documents. Assist the ENGINEER in serving as the OWNER's liaison with the CONTRACTOR when the CONTRACTOR's operations affect the OWNER's on-site operations.
4. As requested by the ENGINEER, assist in obtaining from the OWNER additional details or information, when required at the site for proper execution of the WORK.
5. Receive and record date of receipt of Shop Drawings and samples, receive samples which are furnished at the site by the CONTRACTOR and notify the ENGINEER of their availability for examination.
6. Conduct on-site observations of the WORK in progress to assist the ENGINEER in determining if the WORK is proceeding in accordance with the Contract Documents.
7. Report to the ENGINEER whenever the Inspector believes that any WORK is unsatisfactory, faulty, or defective or does not conform to the Contract Documents, or does not meet the requirements of any inspection, tests or approval required to be made or has been damaged prior to final payment; and advise the ENGINEER when the Inspector believes WORK should be corrected or rejected or should be uncovered for observation, or requires special testing, inspection, or approval.
8. Verify that the tests, equipment, and systems startups and operating and maintenance instruction are conducted as required by the Contract Documents and in presence of the required personnel, and that the CONTRACTOR maintains adequate records thereof; observe, record and report to the ENGINEER appropriate details relative to the test procedures and start-ups.
9. Accompany visiting inspectors representing public or other agencies having jurisdiction over the WORK, record the outcome of these inspections, and report to the ENGINEER.
10. Transmit to the CONTRACTOR the ENGINEER's clarifications and interpretations of the Contract Documents.
11. Consider and evaluate the CONTRACTOR's suggestions for modifications in the Contract Documents and report them with recommendations to the ENGINEER.
12. Maintain at the job site orderly files for correspondence, reports of job conferences, Shop Drawings and sample submittals, reproductions of original Contract Documents including all addenda, Change Orders, field orders, additional Drawings issued

## SECTION 00700 - GENERAL CONDITIONS

subsequent to the execution of the contract, the ENGINEER's clarifications and interpretations of the Contract Documents, progress reports, and other related documents.

13. Keep a diary or log book, recording hours on the job site, weather conditions, data relative to questions of extras or deductions, list all project visitors, daily activities, decisions, observations in general, and specific observations in more detail as in the case of performing and observing test procedures. Send copies to the ENGINEER.
14. Record names, addresses, and telephone numbers of the CONTRACTOR, Subcontractors, and major suppliers of materials and equipment.
15. Furnish the ENGINEER with periodic reports as required of progress of the WORK and the CONTRACTOR's compliance with the accepted progress schedule and schedule of CONTRACTOR submittals.
16. Consult with the ENGINEER in advance of scheduled major tests, inspections, or start of important phases of the WORK.
17. Report immediately to the ENGINEER upon the occurrence of any accident.
18. Review applications for payment with the CONTRACTOR for compliance with the established procedure for their submittal and forward them with recommendations to the ENGINEER, noting particularly their relation to the schedule of values, WORK completed, and materials and equipment delivered at the site but not incorporated in the WORK.
19. During the course of the WORK, verify that certificates, maintenance and operation manuals, and other data required to be assembled and furnished by the CONTRACTOR are applicable to the items actually installed; and deliver this material to the ENGINEER for its review and forwarding to the OWNER prior to final acceptance of the WORK.
20. Before the ENGINEER prepares a Certificate of Substantial Completion/Notice of Completion, as applicable, review the CONTRACTOR's punch list items requiring completion or correction and add any items that CONTRACTOR has omitted.
21. Conduct final inspection in the company of the ENGINEER, the OWNER, and the CONTRACTOR, and prepare a final punch list of items to be completed or corrected.
22. Verify that all items on the punch list have been completed or corrected and make recommendations to the ENGINEER concerning acceptance.

Limitations of Authority. Except upon written instruction of the ENGINEER, the Inspector:

1. Shall not authorize any deviation from the Contract Documents or approve any substitute material or equipment.
2. Shall not exceed limitations on the ENGINEER's authority as set forth in the Contract Documents.
3. Shall not undertake any of the responsibilities of the CONTRACTOR, Subcontractors or CONTRACTOR's superintendent, or expedite the WORK.
4. Shall not advise on or issue directions relative to any aspect of the means, methods, techniques, sequences, or procedures of construction unless such is specifically called for in the Contract Documents.
5. Shall not advise on or issue directions as to safety precautions and programs in connection with the WORK.

9.4 CLARIFICATIONS AND INTERPRETATIONS. The ENGINEER will issue with reasonable promptness such written clarifications or interpretations of the requirements of the Contract

## SECTION 00700 - GENERAL CONDITIONS

Documents (in the form of Drawings or otherwise) as the ENGINEER may determine necessary, which shall be consistent with, or reasonably inferred from, the overall intent of the Contract Documents.

- 9.5 AUTHORIZED VARIATIONS IN WORK. The ENGINEER may authorize variations in the WORK from the requirements of the Contract Documents. These may be accomplished by a Field Order and will require the CONTRACTOR to perform the WORK involved in a manner that minimizes the impact to the WORK and the contract completion date. If the CONTRACTOR believes that a Field Order justifies an increase in the Contract Price or an extension of the Contract Time, the CONTRACTOR may make a claim therefor as provided in Article 11 or 12.
- 9.6 REJECTING DEFECTIVE WORK. The ENGINEER will have authority to reject WORK which the ENGINEER believes to be defective and will also have authority to require special inspection or testing of the WORK as provided in Paragraph 13.3G, whether or not the WORK is fabricated, installed, or completed.
- 9.7 CONTRACTOR SUBMITTALS, CHANGE ORDERS, AND PAYMENTS
- A. In accordance with the procedures set forth in the General Requirements, the ENGINEER will review all CONTRACTOR submittals, including Shop Drawings, samples, substitutes, or "or equal" items, etc., in order to determine if the items covered by the submittals will, after installation or incorporation in the WORK, conform to the requirements of the Contract Documents and be compatible with the design concept of the completed project as a functioning whole as indicated by the Contract Documents. The ENGINEER's review will not extend to means, methods, techniques, sequences or procedures of construction or to safety precautions or programs incident thereto.
  - B. In connection with the ENGINEER's responsibilities as to Change Orders, see Articles 10, 11, and 12.
  - C. In connection with the ENGINEER's responsibilities in respect of Applications for Payment, see Article 14.
- 9.8 DECISIONS ON DISPUTES
- A. The ENGINEER will be the initial interpreter of the requirements of the Contract Documents and judge of the acceptability of the WORK thereunder. Claims, disputes, and other matters relating to the acceptability of the WORK; the interpretation of the requirements of the Contract Documents pertaining to the performance of the WORK; and those claims under Articles 11 and 12 in respect to changes in the Contract Price or Contract Time will be referred initially to the ENGINEER in writing with a request for formal decision in accordance with this paragraph, which the ENGINEER will render in writing within 30 days of receipt of the request. Written notice of each such claim, dispute, and other matter will be delivered by the CONTRACTOR to the ENGINEER promptly (but in no event later than 30 days) after the occurrence of the event giving rise thereto. Written supporting data will be submitted to the ENGINEER within 60 days after such occurrence unless the ENGINEER allows an additional period of time to ascertain more accurate data in support of the claim.

## SECTION 00700 - GENERAL CONDITIONS

- B. The rendering of a decision by the ENGINEER with respect to any such claim, dispute, or other matter (except any which have been waived by the making or acceptance of final payment as provided in Paragraph 14.12) will be a condition precedent to any exercise by the OWNER or the CONTRACTOR of such rights or remedies as either may otherwise have under the Contract Documents or by Law or Regulations in respect of any such claim, dispute, or other matter.

### 9.9 LIMITATION ON ENGINEER'S RESPONSIBILITIES

- A. Neither the ENGINEER's authority to act under this Article or other provisions of the Contract Documents nor any decision made by the ENGINEER in good faith either to exercise or not exercise such authority shall give rise to any duty or responsibility of the ENGINEER to the CONTRACTOR, any Subcontractor, any Supplier, any surety for any of them, or any other person or organization performing any of the WORK.
- B. Whenever in the Contract Documents the terms "as ordered," "as directed," "as required," "as allowed," "as reviewed," "as approved," or terms of like effect or import are used, or the adjectives "reasonable," "suitable," "acceptable," "proper," or "satisfactory" or adjectives of like effect or import are used to describe a requirement, direction, review, or judgment of the ENGINEER as to the WORK, it is intended that such requirement, direction, review, or judgment will be solely to evaluate the WORK for compliance with the requirements of the Contract Documents, and conformance with the design concept of the completed Project as a functioning whole as indicated by the Contract Documents, unless there is a specific statement indicating otherwise. The use of any such term or adjective shall not be effective to assign to the ENGINEER any duty or authority to supervise or direct the performance of the WORK or any duty or authority to undertake responsibility contrary to the provisions of Paragraph 9.9C or 9.9D.
- C. The ENGINEER will not supervise, direct, control, or have authority over or be responsible for the CONTRACTOR's means, methods, techniques, sequences, or procedures of construction, or the safety precautions and programs incident thereto, or for any failure of the CONTRACTOR to comply with Laws and Regulations, applicable to the performance of the WORK. The ENGINEER will not be responsible for the CONTRACTOR's failure to perform the WORK in accordance with the Contract Documents.
- D. The ENGINEER will not be responsible for the acts or omissions of the CONTRACTOR nor of any Subcontractor, supplier, or any other person or organization performing any of the WORK.



## SECTION 00700 - GENERAL CONDITIONS

### ARTICLE 10 CHANGES IN THE WORK

#### 10.1 GENERAL

- A. Without invalidating the Agreement and without notice to any surety, the OWNER may at any time or from time to time, order additions, deletions, or revisions in the WORK; these will be authorized by a written Field Order and/or a Change Order issued by the ENGINEER.
- B. If the CONTRACTOR believes that it is entitled to an increase or decrease in the Contract Price, or an extension or shortening in the Contract Time as the result of a Field Order, a claim may be made as provided in Articles 11 and 12.
- C. If the OWNER and CONTRACTOR agree on the value of any work, or the amount of Contract Time that should be allowed as a result of a Field Order, upon receiving written notice from the ENGINEER, the CONTRACTOR shall proceed so as to minimize the impact on and delays to the work pending the issuance of a Change Order.
- D. If the OWNER and the CONTRACTOR are unable to agree as to the extent, if any, of an increase or decrease in the Contract Price or an extension or shortening of the Contract Time that should be allowed as a result of a Field Order, the ENGINEER can direct the CONTRACTOR to proceed on the basis of Time and Materials so as to minimize the impact on and delays to WORK, and a claim may be made therefor as provided in Articles 11 and 12.
- E. The CONTRACTOR shall not be entitled to an increase in the Contract Price nor an extension of the Contract Time with respect to any work performed that is not required by the Contract Documents as amended, modified, supplemented by Change Order, except in the case of an emergency and except in the case of uncovering work as provided in Paragraph 13.3G.
- F. The OWNER and the CONTRACTOR shall execute appropriate Change Orders covering:
  - 1. changes in the WORK which are ordered by the OWNER pursuant to Paragraph 10.1A;
  - 2. changes required because of acceptance of Defective WORK under Paragraph 13.7;
  - 3. changes in the Contract Price or Contract Time which are agreed to by the parties; or
  - 4. changes in the Contract Price or Contract Times which embody the substance of any written decision rendered by the ENGINEER pursuant to Paragraph 9.8.
- G. If notice of any change is required by the provisions of any Bond to be given to a surety, the giving of any such notice will be the CONTRACTOR's responsibility, and the amount of each applicable Bond shall be adjusted accordingly.

#### 10.2 ALLOWABLE QUANTITY VARIATIONS

- A. In the event of an increase or decrease in Bid item quantity of a unit price contract, the total amount of WORK actually done or materials or equipment furnished shall be paid for according to the unit price established for such WORK under the Contract Documents, wherever such unit price has been established; provided, that an adjustment in the Contract Price may be made for changes which result in an increase or decrease in excess of 25% of

## SECTION 00700 - GENERAL CONDITIONS

the estimated quantity of any major item of the WORK. Major Item is defined as any bid item amount that is ten percent (10%) or more of the total contract amount.

- B. In the event a part of the WORK is to be entirely eliminated and no lump sum or unit price is named in the Contract Documents to cover such eliminated work, the price of the eliminated work shall be agreed upon in writing by the OWNER and the CONTRACTOR. If the OWNER and the CONTRACTOR fail to agree upon the price of the eliminated work, said price shall be determined in accordance with the provisions of Article 11.

### ARTICLE 11 CHANGE OF CONTRACT PRICE

#### 11.1 GENERAL

- A. The Contract Price constitutes the total compensation payable to the CONTRACTOR for performing the WORK. All duties, responsibilities, and obligations assigned to or undertaken by the CONTRACTOR to complete the WORK shall be at its expense without change in the Contract Price.
- B. The Contract Price may only be changed by a Change Order. Any claim for an increase in the Contract Price shall be based on written notice delivered by the CONTRACTOR to the ENGINEER promptly (but in no event later than 7 days) after the start of the occurrence or the event giving rise to the claim and stating the general nature of the claim. Notice of the amount of the claim with supporting data shall be delivered within 14 days after such occurrence (unless the ENGINEER allows an additional period of time to ascertain more accurate data in support of the claim) and shall be accompanied by the CONTRACTOR's written statement that the amount claimed covers all known amounts (direct, indirect, and consequential) to which the CONTRACTOR is entitled as a result of said occurrence or event. All claims for adjustment in the Contract Price shall be determined by the ENGINEER in accordance with Paragraph 9.8A if the OWNER and the CONTRACTOR cannot otherwise agree on the amount involved. No claim for an adjustment in the Contract Price will be valid if not submitted in accordance with this Paragraph 11.1B.
- C. The value of any WORK covered by a Change Order or of any claim for an increase or decrease in the Contract Price shall be determined in one of the following ways:
  - 1. Where the WORK involved is covered by unit prices contained in the Contract Documents, by application of unit prices to the quantities of the items involved.
  - 2. By mutual acceptance of a lump sum, which may include an allowance for overhead and profit not necessarily in accordance with Paragraph 11.4.
  - 3. On the basis of the cost of WORK (determined as provided in Paragraphs 11.3) plus a CONTRACTOR's fee for overhead and profit (determined as provided in Paragraph 11.4).

- 11.2 COSTS RELATING TO WEATHER. The CONTRACTOR shall have no claims against the OWNER for damages for any injury to WORK, materials, or equipment, resulting from the action of the elements. If, however, in the opinion of the ENGINEER, the CONTRACTOR has made all reasonable efforts to protect the materials, equipment and work, the CONTRACTOR may be granted a reasonable extension of Contract Time to make proper repairs, renewals, and replacements of the work, materials, or equipment.

## SECTION 00700 - GENERAL CONDITIONS

### 11.3 COST OF WORK (BASED ON TIME AND MATERIALS)

- A. General. The term "cost of work" means the sum of all costs necessarily incurred and paid by the CONTRACTOR for labor, materials, and equipment in the proper performance of extra work. Except as otherwise may be agreed to in writing by the OWNER, such costs shall be in amounts no higher than those prevailing in the locality of the Project; shall include only the following items, and shall not include any of the costs itemized in Paragraph 11.5 EXCLUDED COSTS.
- B. Labor. The costs of labor will be the actual cost for wages prevailing for each craft or type of workers performing the extra work at the time the extra work is done, plus employer payments of payroll taxes, worker's compensation insurance, liability insurance, health and welfare, pension, vacation, apprenticeship funds, and other direct costs resulting from Federal, State or local laws, as well as assessments or benefits required by lawful collective bargaining agreements. Labor costs for equipment operators and helpers shall be paid only when such costs are not included in the invoice for equipment rental. The labor costs for forepersons shall be proportioned to all of their assigned work and only that applicable to extra work shall be paid. Non-direct labor costs including superintendence shall be considered part of the mark-up set out in paragraph 11.4.
- C. Materials. The cost of materials reported shall be at invoice or lowest current price at which materials are locally available and delivered to the job in the quantities involved, plus the cost of freight, delivery and storage, subject to the following:
1. Trade discounts available to the purchaser shall be credited to the OWNER notwithstanding the fact that such discounts may not have been taken by the CONTRACTOR.
  2. For materials secured by other than a direct purchase and direct billing to the purchaser, the cost shall be deemed to be the price paid to the actual supplier as determined by the ENGINEER. Mark-up except for actual costs incurred in the handling of such materials will not be allowed.
  3. Payment for materials from sources owned wholly or in part by the purchaser shall not exceed the price paid by the purchaser for similar materials from said sources on extra work items or the current wholesale price for such materials delivered to the work site, whichever price is lower.
  4. If in the opinion of the ENGINEER the cost of material is excessive, or the CONTRACTOR does not furnish satisfactory evidence of the cost of such material, then the cost shall be deemed to be the lowest current wholesale price for the quantity concerned delivered to the work site less trade discount. The OWNER reserves the right to furnish materials for the extra work and no claim shall be allowed by the CONTRACTOR for costs and profit on such materials.
- D. Equipment. The CONTRACTOR will be paid for the use of equipment at the rental rate listed for such equipment specified in the Supplementary General Conditions. Such rental rate will be used to compute payments for equipment whether the equipment is under the CONTRACTOR's control through direct ownership, leasing, renting, or another method of acquisition. The rental rate to be applied for use of each item of equipment shall be the rate resulting in the least total cost to the OWNER for the total period of use. If it is deemed

## SECTION 00700 - GENERAL CONDITIONS

necessary by the CONTRACTOR to use equipment not listed in the publication specified in the Supplementary General Conditions, an equitable rental rate for the equipment will be established by the ENGINEER. The CONTRACTOR may furnish cost data which might assist the ENGINEER in the establishment of the rental rate.

1. All equipment shall, in the opinion of the ENGINEER, be in good working condition and suitable for the purpose for which the equipment is to be used.
  2. Before construction equipment is used on the extra work, the CONTRACTOR shall plainly stencil or stamp an identifying number thereon at a conspicuous location, and shall furnish to the ENGINEER, in duplicate, a description of the equipment and its identifying number.
  3. Unless otherwise specified, manufacturer's ratings and manufacturer approved modifications shall be used to classify equipment for the determination of applicable rental rates. Equipment which has no direct power unit shall be powered by a unit of at least the minimum rating recommended by the manufacturer.
  4. Individual pieces of equipment or tools having a replacement value of \$200 or less, whether or not consumed by use, shall be considered to be small tools and no payment will be made therefor.
  5. Rental time will not be allowed while equipment is inoperative due to breakdowns.
  6. Equipment Rental Rates. Unless otherwise agreed in writing, the CONTRACTOR will be paid for the use of equipment at the rental rate listed for such equipment specified in the current edition of the following reference publication: "Rental Rate Blue Book" as published by Dataquest (a company of the Dunn and Bradstreet Corporation), 1290 Ridder Park Drive, San Jose, CA 95131, telephone number (800) 227-8444.
- E. Equipment on the Work Site. The rental time to be paid for equipment on the work site shall be the time the equipment is in productive operation on the extra work being performed and, in addition, shall include the time required to move the equipment to the location of the extra work and return it to the original location or to another location requiring no more time than that required to return it to its original location; except, that moving time will not be paid if the equipment is used on other than the extra work, even though located at the site of the extra work. Loading and transporting costs will be allowed, in lieu of moving time, when the equipment is moved by means other than its own power, except that no payment will be made for loading and transporting costs when the equipment is used at the site of the extra work on other than the extra work. The following shall be used in computing the rental time of equipment on the work site.
1. When hourly rates are listed, any part of an hour less than 30 minutes of operation shall be considered to be 1/2-hour of operation, and any part of an hour in excess of 30 minutes will be considered one hour of operation.
  2. When daily rates are listed, any part of a day less than 4 hours operation shall be considered to be 1/2-day of operation. When owner-operated equipment is used to perform extra work to be paid for on a time and materials basis, the CONTRACTOR will be paid for the equipment and operator, as set forth in Paragraphs (3), (4), and (5), following.
  3. Payment for the equipment will be made in accordance with the provisions in Paragraph 11.3D, herein.
  4. Payment for the cost of labor and subsistence or travel allowance will be made at the rates paid by the CONTRACTOR to other workers operating similar equipment already

## SECTION 00700 - GENERAL CONDITIONS

on the work site, or in the absence of such labor, established by collective bargaining agreements for the type of worker and location of the extra work, whether or not the operator is actually covered by such an agreement. A labor surcharge will be added to the cost of labor described herein in accordance with the provisions of Paragraph 11.3B, herein, which surcharge shall constitute full compensation for payments imposed by state and federal laws and all other payments made to or on behalf of workers other than actual wages.

5. To the direct cost of equipment rental and labor, computed as provided herein, will be added the allowances for equipment rental and labor as provided in Paragraph 11.4, herein.
- F. Specialty Work. Specialty work is defined as that work characterized by extraordinary complexity, sophistication, or innovation or a combination of the foregoing attributes which are unique to the construction industry. The following shall apply in making estimates for payment for specialty work:
1. Any bid item of WORK to be classified as Specialty Work shall be listed as such in the Supplementary General Conditions. Specialty work shall be performed by an entity especially skilled in the work to be performed. After validation of invoices and determination of market values by the ENGINEER, invoices for specialty work based upon the current fair market value thereof may be accepted without complete itemization of labor, material, and equipment rental costs.
  2. When the CONTRACTOR is required to perform work necessitating special fabrication or machining process in a fabrication or a machine shop facility away from the job site, the charges for that portion of the work performed at the off-site facility may, by agreement, be accepted as specialty work and accordingly, the invoices for the work may be accepted without detailed itemization.
  3. All invoices for specialty work will be adjusted by deducting all trade discounts offered or available, whether the discounts were taken or not. In lieu of the allowances for overhead and profit specified in Paragraph 11.4, herein, an allowance of 5 percent will be added to invoices for specialty work.
- G. Sureties. All work performed hereunder shall be subject to all of the provisions of the Contract Documents and the CONTRACTOR's sureties shall be bound with reference thereto as under the original Agreement. Copies of all amendments to surety bonds or supplemental surety bonds shall be submitted to the OWNER for review prior to the performance of any work hereunder.

### 11.4 CONTRACTOR'S FEE

- A. Extra work ordered on the basis of time and materials will be paid for at the actual necessary cost as determined by the ENGINEER, plus allowances for overhead and profit. The allowance for overhead and profit shall include full compensation for superintendence, bond and insurance premiums, taxes, field office expense, extended overhead, home office overhead, and all other items of expense or cost not included in the cost of labor, materials, or equipment provided for under Paragraph 11.3. The allowance for overhead and profit will be made in accordance with the following schedule:

**SECTION 00700 - GENERAL CONDITIONS**

Actual Overhead and Profit Allowance

Labor.....	15 percent
Materials .....	10 percent
Equipment.....	10 percent

To the sum of the costs and mark-ups provided for in this Article, one percent shall be added as compensation for bonding.

- B. It is understood that labor, materials, and equipment may be furnished by the CONTRACTOR or by the Subcontractor on behalf of the CONTRACTOR. When all or any part of the extra work is performed by a Subcontractor, the allowance specified herein shall be applied to the labor, materials, and equipment costs of the Subcontractor, to which the CONTRACTOR may add 5 percent of the Subcontractor's total cost for the extra work. Regardless of the number of hierarchical tiers of Subcontractors, the 5 percent increase above the Subcontractor's total cost which includes the allowances for overhead and profit specified herein may be applied one time only.

11.5 EXCLUDED COSTS. The term "Cost of the Work" shall not include any of the following:

- A. Payroll costs and other compensation of CONTRACTOR's officers, executives, principals (of partnership and sole proprietorships), general managers, engineers, estimators, attorneys' auditors, accountants, purchasing and contracting agents, expenditures, timekeepers, clerks and other personnel employed by CONTRACTOR whether at the site or in CONTRACTOR's principal or a branch office for general administration of the work, or not specifically covered by paragraph 11.3, all of which are to be considered administrative costs covered by the CONTRACTOR's fee.
- B. Expenses of CONTRACTOR's principal and branch offices other than CONTRACTOR's office at the site.
- C. Any part of CONTRACTOR's capital expenses, including interest on CONTRACTOR's capital employed for the WORK and charges against CONTRACTOR for delinquent payments.
- D. Cost of premiums for all bonds and for all insurance whether or not CONTRACTOR is required by the Contract Documents to purchase and maintain the same (except for the cost of premiums covered by paragraph 11.4 above).
- E. Costs due to the negligence of CONTRACTOR , any Subcontractor, or anyone directly or indirectly employed by any of them or for whose acts any of them may be liable, including but not limited to, the correction of Defective WORK, disposal of materials or equipment wrongly supplied and making good any damage to property.
- F. Other overhead or general expense costs of any kind and the cost of any item not specifically and expressly included in paragraph 11.4.

## SECTION 00700 - GENERAL CONDITIONS

### ARTICLE 12 CHANGE OF CONTRACT TIME

#### 12.1 GENERAL

- A. The Contract Time may only be changed by a Change Order. Any claim for an extension of the Contract Time (or Milestones) shall be based on written notice delivered by the CONTRACTOR to the ENGINEER promptly (but in no event later than 30 days) after the occurrence of the event giving rise to the claim and stating the general nature of the claim. Notice of the extent of the claim with supporting data shall be delivered within 60 days after such occurrence (unless the ENGINEER allows an additional period of time to ascertain more accurate data in support of the claim) and shall be accompanied by the CONTRACTOR's written statement that the adjustment claimed is the entire adjustment to which the CONTRACTOR has reason to believe it is entitled as a result of the occurrence of said event. All claims for adjustment in the Contract Time shall be determined by the ENGINEER in accordance with Paragraph 9.8 if the OWNER and the CONTRACTOR cannot otherwise agree. No claim for an adjustment in the Contract Time will be valid if not submitted in accordance with the requirements of this Paragraph 12.1A. An increase in Contract Time does not mean that the Contractor is due an increase in Contract Price. Only compensable time extensions will result in an increase in Contract Price.
- B. All time limits stated in the Contract Documents are of the essence of the Agreement.
- C. Where CONTRACTOR is prevented from completing any part of the WORK within the Contract Times (or Milestones) due to delay beyond the control of CONTRACTOR, the Contract Times (or Milestones) will be extended in an amount equal to the time lost on the critical path of the project due to such delay if a claim is made therefor as provided in paragraph 12.1. Delays beyond the control of CONTRACTOR shall include, but not be limited to, acts or neglect by OWNER, acts or neglect of utility owners or other contractors performing other work as contemplated by Article 7, fires, floods, epidemics, unprecedented weather conditions or acts of God. Delays attributable to and within the control of a Subcontractor or Supplier shall be deemed to be delays within the control of CONTRACTOR.
- D. Where CONTRACTOR is prevented from completing any part of the WORK within the Contract Times (or Milestones) due to delay beyond the control of both OWNER and CONTRACTOR, an extension of the Contract Times (or Milestones) in an amount equal to the time lost on the critical path of the project due to such delay shall be CONTRACTOR's sole and exclusive remedy for such delay. In no event shall the OWNER be liable to CONTRACTOR, any Subcontractor, any Supplier, or any other person or organization, or to any surety for or employee or agent of any of them, for damages arising out of or resulting from (i) delays caused by or within the control of CONTRACTOR, or (ii) delays beyond the control of both parties including but not limited to fires, floods, epidemics abnormal weather conditions, acts of God or acts or neglect by utility owners or other contractors performing other work as contemplated by Article 7.

12.2 EXTENSIONS OF TIME FOR DELAY DUE TO WEATHER. Contract Time may be extended by the ENGINEER because of delays in completion of the WORK due to unusually severe weather, provided that the CONTRACTOR shall, within 10 days of the beginning of any such delay, notify the ENGINEER in writing of the cause of delay and request an extension of Contract Time. The

## SECTION 00700 - GENERAL CONDITIONS

ENGINEER will ascertain the facts and the extent of the delay and extend the time for completing the work when, in the ENGINEER's judgment, the findings of fact justify such an extension. Unprecedented, abnormal, or unusually severe weather will be defined as an event, or events, with a greater than 50-year recurrence interval, as determined by the National Weather Service, or equivalent State or Federal agency

### **ARTICLE 13 WARRANTY AND GUARANTEE; TESTS AND INSPECTIONS; CORRECTION, REMOVAL, OR ACCEPTANCE OF DEFECTIVE WORK**

- 13.1 **WARRANTY AND GUARANTEE.** The CONTRACTOR warrants and guarantees to the OWNER and the ENGINEER that all work will be in accordance with the Contract Documents and will not be defective. Prompt notice of defects known to the OWNER or ENGINEER shall be given to the CONTRACTOR. All defective work, whether or not in place, may be rejected, corrected, or accepted as provided in this Article 13.
- 13.2 **ACCESS TO WORK.** OWNER, ENGINEER, their Consultants, sub-consultants, other representatives and personnel of OWNER, independent testing laboratories and governmental agencies with jurisdictional interests will have access to the WORK at reasonable times for their observation, inspecting and testing. CONTRACTOR shall provide them proper and safe conditions for such access and advise them of CONTRACTOR's site safety procedures and programs so that they may comply therewith as applicable.
- 13.3 **TESTS AND INSPECTIONS**
- A. The CONTRACTOR shall give the ENGINEER timely notice of readiness of the WORK for all required inspections, tests, or approvals, and shall cooperate with inspection and testing personnel to facilitate required inspections or tests.
  - B. If Laws or Regulations of any public body having jurisdiction other than the OWNER require any WORK to specifically be inspected, tested, or approved, the CONTRACTOR shall pay all costs in connection therewith. The CONTRACTOR shall also be responsible for and shall pay all costs in connection with any inspection or testing required in connection with the OWNER's or the ENGINEER's acceptance of a Supplier of materials or equipment proposed as a substitution or (or-equal) to be incorporated in the WORK, or of materials or equipment submitted for review prior to the CONTRACTOR's purchase thereof for incorporation in the WORK. The cost of all inspections, tests, and approvals in addition to the above which are required by the Contract Documents shall be paid by the OWNER (unless otherwise specified).
  - C. The ENGINEER will make, or have made, such inspections and tests as the ENGINEER deems necessary to see that the WORK is being accomplished in accordance with the requirements of the Contract Documents. Unless otherwise specified in the Supplementary General Conditions, the cost of such inspection and testing will be borne by the OWNER. In the event such inspections or tests reveal non-compliance with the requirements of the Contract Documents, the CONTRACTOR shall bear the cost of corrective measures deemed necessary by the ENGINEER, as well as the cost of subsequent reinspection and retesting. Neither observations by the ENGINEER nor inspections, tests, or approvals by others shall relieve the CONTRACTOR from the CONTRACTOR's obligation to perform the WORK in accordance with the Contract Documents.



## SECTION 00700 - GENERAL CONDITIONS

- D. All inspections, tests, or approvals other than those required by Laws or Regulations of any public body having jurisdiction shall be performed by organizations acceptable to the ENGINEER and the CONTRACTOR.
  - E. If any WORK (including the work of others) that is to be inspected, tested, or approved is covered without written concurrence of the ENGINEER, it must, if requested by the ENGINEER, be uncovered for observation. Such uncovering shall be at the CONTRACTOR's expense unless the CONTRACTOR has given the ENGINEER timely notice of the CONTRACTOR's intention to perform such test or to cover the same and the ENGINEER has not acted with reasonable promptness in response to such notice.
  - F. If any WORK is covered contrary to the written request of the ENGINEER, it must, if requested by the ENGINEER, be uncovered for the ENGINEER's observation and recovered at the CONTRACTOR's expense.
  - G. If the ENGINEER considers it necessary or advisable that covered WORK be observed by the ENGINEER or inspected or tested by others, the CONTRACTOR, at the ENGINEER's request, shall uncover, expose, or otherwise make available for observation, inspection, or testing as the ENGINEER may require, that portion of the WORK in question, furnishing all necessary labor, material, and equipment. If it is found that such WORK is defective, the CONTRACTOR shall bear all direct, indirect, and consequential costs and damages of such uncovering, exposure, observation, inspection, and testing and of satisfactory reconstruction, including but not limited to fees and charges of engineers, attorneys, and other professionals. However, if such WORK is not found to be defective, the CONTRACTOR shall be allowed an increase in the Contract Price or an extension of the Contract Time, or both, directly attributable to such uncovering, exposure, observation, inspection, testing, and reconstruction; and, if the parties are unable to agree as to the amount or extent thereof, the CONTRACTOR may make a claim therefor as provided in Articles 11 and 12.
- 13.4 OWNER MAY STOP THE WORK. If the WORK is defective, or the CONTRACTOR fails to perform work in such a way that the completed WORK will conform to the Contract Documents, the OWNER may order the CONTRACTOR to stop the WORK, or any portion thereof, until the cause for such order has been eliminated; however, this right of the OWNER to stop the WORK shall not give rise to any duty on the part of the OWNER to exercise this right for the benefit of the CONTRACTOR or any other party.
- 13.5 CORRECTION OR REMOVAL OF DEFECTIVE WORK. If required by the ENGINEER, the CONTRACTOR shall promptly, either correct all defective work, whether or not fabricated, installed, or completed, or, if the WORK has been rejected by the ENGINEER, remove it from the site and replace it with non-defective work. The CONTRACTOR shall bear all direct, indirect and consequential costs and damages of such correction or removal, including but not limited to fees and charges of engineers, attorneys, and other professionals made necessary thereby.

## SECTION 00700 - GENERAL CONDITIONS

### 13.6 ONE YEAR CORRECTION PERIOD

- A. If within one year after the date of Substantial Completion or such longer period of time as may be prescribed by Laws or Regulations or by the terms of any applicable special guarantee required by the Contract Documents or by any specific provision of the Contract Documents, any work is found to be defective, the CONTRACTOR shall promptly, without cost to the OWNER and in accordance with OWNER's written notification, (i) correct such Defective WORK, or, if it has been rejected by the OWNER, remove it from the site and replace it with non-defective work, and (ii) satisfactorily correct or remove and replace any damage to other work of others resulting therefrom. If the CONTRACTOR does not promptly comply with such notification, or in an emergency where delay would cause serious risk of loss or damage, the OWNER may have the Defective WORK corrected or the rejected WORK removed and replaced, and all direct, indirect, and consequential costs and damages of such removal and replacement including but not limited to fees and charges of engineers, attorneys and other professionals will be paid by the CONTRACTOR.
- B. Where Defective WORK (and damage to other WORK resulting therefrom) has been corrected, removed or replaced under this paragraph 13.6, the correction period hereunder with respect to such WORK will be extended for an additional period of one year after such correction or removal and replacement has been satisfactorily completed.

13.7 ACCEPTANCE OF DEFECTIVE WORK. If, instead of requiring correction or removal and replacement of defective work, the OWNER prefers to accept the WORK, the OWNER may do so. The CONTRACTOR shall bear all direct, indirect, and consequential costs attributable to the OWNER's evaluation of and determination to accept such defective work. If any such acceptance occurs prior to final payment, a Change Order will be issued incorporating the necessary revisions in the Contract Documents with respect to the WORK, and the OWNER shall be entitled to an appropriate decrease in the Contract Price.

## ARTICLE 14 PAYMENTS TO CONTRACTOR AND COMPLETION

14.1 SCHEDULE OF VALUES (LUMP SUM PRICE BREAKDOWN). The schedule of values or lump sum price breakdown established as provided in the General Requirements shall serve as the basis for progress payments and will be incorporated into a form of Application for Payment acceptable to the ENGINEER.

14.2 UNIT PRICE BID SCHEDULE. Progress payments on account of Unit Price work will be based on the number of units completed.

### 14.3 APPLICATION FOR PROGRESS PAYMENT

- A. Unless otherwise prescribed by law, on the 25th of each month, the CONTRACTOR shall submit to the ENGINEER for review, an Application for Payment filled out and signed by the CONTRACTOR covering the WORK completed as of the date of the Application and accompanied by such supporting documentation as is required by the Contract Documents.
- B. The Application for Payment shall identify, as a sub-total, the amount of the CONTRACTOR'S Total Earnings to Date, plus the Value of Materials Stored at the Site which have not yet been incorporated in the WORK, and less a deductive adjustment for

## SECTION 00700 - GENERAL CONDITIONS

materials installed which were not previously incorporated in the WORK, but for which payment was allowed under the provisions for payment for Materials Stored at the Site, but not yet incorporated in the WORK.

- C. The Net Payment Due the CONTRACTOR shall be the above-mentioned subtotal from which shall be deducted the total amount of all previous payments made to the CONTRACTOR. Progress payments will be paid in full in accordance with Article 14 of the General Conditions until 90% of the Contract Price has been paid. The remaining 10% of the Contract Price amount may be withheld until:

1. final inspection has been made;
2. completion of the Project; and
3. acceptance of the Project by the OWNER.

- D. The Value of Materials Stored at the Site shall be an amount equal to the specified percent of the value of such materials as set forth in the Supplementary General Conditions. Said amount shall be based upon the value of all acceptable materials and equipment not incorporated in the WORK but delivered and suitably stored at the site or at another location agreed to in writing; provided, each such individual item has a value of more than \$5,000.00 and will become a permanent part of the WORK. The Application for Payment shall also be accompanied by an invoice (including shipping), a certification that the materials meet the applicable contract specifications, and any evidence required by the OWNER that the materials and equipment are covered by appropriate property insurance and other arrangements to protect the OWNER's interest therein, all of which will be satisfactory to the OWNER. Payment for materials will not constitute final acceptance. It shall be the CONTRACTOR's responsibility to protect the material from damage, theft, loss, or peril while in storage. Unless otherwise prescribed by law, the Value of Materials Stored at the Site shall be paid at the invoice amount up to a maximum of 85% of the Contract Price for those items.

- 14.4 CONTRACTOR'S WARRANTY OF TITLE. The CONTRACTOR warrants and guarantees that title to all work, materials, and equipment covered by an Application for Payment, whether incorporated in the WORK or not, will pass to the OWNER no later than the time of payment free and clear of all liens.

### 14.5 REVIEW OF APPLICATIONS FOR PROGRESS PAYMENT

- A. The ENGINEER will, within 7 days after receipt of each Application for Payment, either indicate in writing a recommendation of payment and present the Application to the OWNER, or return the Application to the CONTRACTOR indicating in writing the ENGINEER's reasons for refusing to recommend payment. In the later case, the CONTRACTOR may make the necessary corrections and resubmit the Application. If the ENGINEER still disagrees with a portion of the Application, it will submit the Application recommending the undisputed portion of the Application to the OWNER for payment and provide reasons for recommending non-payment of the disputed amount. Thirty days after presentation of the Application for Payment with the ENGINEER's recommendation, the amount recommended will (subject to the provisions of Paragraph 14.5B) become due and when due will be paid by the OWNER to the CONTRACTOR.

## SECTION 00700 - GENERAL CONDITIONS

- B. The OWNER may refuse to make payment of the full amount recommended by the ENGINEER because claims have been made against the OWNER on account of the CONTRACTOR's performance of the WORK or Liens have been filed in connection with the WORK or there are other items entitling the OWNER to a credit against the amount recommended, but the OWNER must give the CONTRACTOR written notice within 7 days (with a copy to the ENGINEER) stating the reasons for such action.

### 14.6 PARTIAL UTILIZATION

- A. The OWNER shall have the right to utilize or place into service any item of equipment or other usable portion of the WORK prior to completion of the WORK. Whenever the OWNER plans to exercise said right, the CONTRACTOR will be notified in writing by the OWNER, identifying the specific portion or portions of the WORK to be so utilized or otherwise placed into service.
- B. It shall be understood by the CONTRACTOR that until such written notification is issued, all responsibility for care and maintenance of all of the WORK shall be borne by the CONTRACTOR. Upon issuance of said written notice of partial utilization, the OWNER will accept responsibility for the protection and maintenance of all such items or portions of the WORK described in the written notice.
- C. The CONTRACTOR shall retain full responsibility for satisfactory completion of the WORK, regardless of whether a portion thereof has been partially utilized by the OWNER and the CONTRACTOR's one year correction period shall commence only after the date of Substantial Completion for the WORK.

14.7 **SUBSTANTIAL COMPLETION.** When the CONTRACTOR considers the WORK ready for its intended use the CONTRACTOR shall notify the OWNER and the ENGINEER in writing that the WORK is substantially complete. The CONTRACTOR will attach to this request a list of all work items that remain to be completed and a request that the ENGINEER prepare a Notice of Completion. Within a reasonable time thereafter, the OWNER, the CONTRACTOR, and the ENGINEER shall make an inspection of the WORK to determine the status of completion. If the ENGINEER does not consider the WORK substantially complete, or the list of remaining work items to be comprehensive, the ENGINEER will notify the CONTRACTOR in writing giving the reasons therefor. If the ENGINEER considers the WORK substantially complete, the ENGINEER will prepare and deliver to the OWNER, for its execution and recording, the Notice of Completion signed by the ENGINEER and CONTRACTOR, which shall fix the date of Substantial Completion.

14.8 **FINAL APPLICATION FOR PAYMENT.** After the CONTRACTOR has completed all of the remaining work items referred to in Paragraph 14.7 and delivered all maintenance and operating instructions, schedules, guarantees, Bonds, certificates of inspection, record as-built documents (as provided in the General Requirements) and other documents, all as required by the Contract Documents, and after the ENGINEER has indicated that the WORK is acceptable, the CONTRACTOR may make application for final payment following the procedure for progress payments. The final Application for Payment shall be accompanied by all documentation called for in the Contract Documents, together with complete and legally effective releases or waivers (satisfactory to the OWNER) of all liens arising out of or filed in connection with the WORK.

## SECTION 00700 - GENERAL CONDITIONS

### 14.9 FINAL PAYMENT AND ACCEPTANCE

- A. If, on the basis of the ENGINEER's observation of the WORK during construction and final inspection, and the ENGINEER's review of the final Application for Payment and accompanying documentation, all as required by the Contract Documents, the ENGINEER is satisfied that the WORK has been completed and the CONTRACTOR's other obligations under the Contract Documents have been fulfilled, the ENGINEER will, within 14 days after receipt of the final Application for Payment, indicate in writing the ENGINEER's recommendation of payment and present the Application to the OWNER for payment.
- B. After acceptance of the WORK by the OWNER's governing body, the OWNER will make final payment to the CONTRACTOR of the amount remaining after deducting all prior payments and all amounts to be kept or retained under the provisions of the Contract Documents, including the following items:
  - 1. Liquidated damages, as applicable.
  - 2. Two times the value of outstanding items of correction work or punch list items yet uncompleted or uncorrected, as applicable. All such work shall be completed or corrected to the satisfaction of the OWNER within the time stated on the Notice of Completion, otherwise the CONTRACTOR does hereby waive any and all claims to all monies withheld by the OWNER to cover the value of all such uncompleted or uncorrected items.

### 14.10 RELEASE OF RETAINAGE AND OTHER DEDUCTIONS

- A. After executing the necessary documents to initiate the lien period, and not more than 45 days thereafter (based on a 30-day lien filing period and 15-day processing time), the OWNER will release to the CONTRACTOR the retainage funds withheld pursuant to the Agreement, less any deductions to cover pending claims against the OWNER pursuant to Paragraph 14.5B.
- B. After filing of the necessary documents to initiate the lien period, the CONTRACTOR shall have 30 days to complete any outstanding items of correction work remaining to be completed or corrected as listed on a final punch list made a part of the Notice of Completion. Upon expiration of the 45 days, referred to in Paragraph 14.10A, the amounts withheld pursuant to the provisions of Paragraph 14.9B herein, for all remaining work items will be returned to the CONTRACTOR; provided, that said work has been completed or corrected to the satisfaction of the OWNER within said 30 days. Otherwise, the CONTRACTOR does hereby waive any and all claims for all monies withheld by the OWNER under the Contract to cover 2 times the value of such remaining uncompleted or uncorrected items.

- 14.11 CONTRACTOR'S CONTINUING OBLIGATION. The CONTRACTOR's obligation to perform and complete the WORK in accordance with the Contract Documents shall be absolute. Neither recommendation of any progress or final payment by the ENGINEER, nor the issuance of a Notice of Completion, nor any payment by the OWNER to the CONTRACTOR under the Contract Documents, nor any use or occupancy of the WORK or any part thereof by the OWNER, nor any act of acceptance by the OWNER nor any failure to do so, nor any review of a Shop Drawing or sample submittal, will constitute an acceptance of work not in accordance with the Contract Documents or a release of the CONTRACTOR's obligation to perform the WORK in accordance with the Contract Documents.

## SECTION 00700 - GENERAL CONDITIONS

- 14.12 FINAL PAYMENT TERMINATES LIABILITY OF OWNER. Final payment is defined as the last progress payment made to the CONTRACTOR for earned funds, less monies withheld as applicable, pursuant to Paragraph 14.10A. The acceptance by the CONTRACTOR of the final payment referred to in Paragraph 14.9 herein, shall be a release of the OWNER and its agents from all claims of liability to the CONTRACTOR for anything done or furnished for, or relating to, the WORK or for any act of neglect of the OWNER or of any person relating to or affecting the WORK, except demands against the OWNER for the remainder, if any, of the amounts kept or retained under the provisions of Paragraph 14.9 herein; and excepting pending, unresolved claims filed prior to the date of the Notice of Completion.

### ARTICLE 15 SUSPENSION OF WORK AND TERMINATION

- 15.1 SUSPENSION OF WORK BY OWNER. The OWNER, acting through the ENGINEER, may, at any time and without cause, suspend the WORK or any portion thereof for a period of not more than 90 days by notice in writing to the CONTRACTOR. The CONTRACTOR shall resume the WORK on receipt from the ENGINEER of a notice of resumption of work. The CONTRACTOR shall be allowed an increase in the Contract Price or an extension of the Contract Time, or both, directly attributable to any suspension if the CONTRACTOR makes an approved claim therefor as provided in Articles 11 and 12.
- 15.2 TERMINATION OF AGREEMENT BY OWNER (CONTRACTOR DEFAULT)
- A. In the event of default by the CONTRACTOR, the OWNER may give 10 days written notice to the CONTRACTOR of OWNER's intent to terminate the Agreement and provide the CONTRACTOR an opportunity to remedy the conditions constituting the default. It shall be considered a default by the CONTRACTOR whenever CONTRACTOR shall: (1) declare bankruptcy, become insolvent, or assign its assets for the benefit of its creditors; (2) fail to provide materials or quality of work meeting the requirements of the Contract Documents; (3) disregard or violate provisions of the Contract Documents or ENGINEER's instructions; (4) fail to prosecute the WORK according to the approved progress schedule; or, (5) fail to provide a qualified superintendent, competent workers, or materials or equipment meeting the requirements of the Contract Documents. If the CONTRACTOR fails to remedy the conditions constituting default within the time allowed, the OWNER may then issue the Notice of Termination.
- B. In the event the Agreement is terminated in accordance with Paragraph 15.2A, herein, the OWNER may take possession of the WORK and may complete the WORK by whatever method or means the OWNER may select. The cost of completing the WORK shall be deducted from the balance which would have been due the CONTRACTOR had the Agreement not been terminated and the WORK completed in accordance with the Contract Documents. If such cost exceeds the balance which would have been due, the CONTRACTOR shall pay the excess amount to the OWNER. If such cost is less than the balance which would have been due, the CONTRACTOR shall not have claim to the difference.
- 15.3 TERMINATION OF AGREEMENT BY OWNER (FOR CONVENIENCE). The OWNER may terminate the Agreement at any time if it is found that reasons beyond the control of either the OWNER or CONTRACTOR make it impossible or against the OWNER's interests to complete the WORK. In such a case, the CONTRACTOR shall have no claims against the OWNER except: (1) for

## SECTION 00700 - GENERAL CONDITIONS

the value of work performed up to the date the Agreement is terminated; and, (2) for the cost of materials and equipment on hand, in transit, or on definite commitment, as of the date the Agreement is terminated which would be needed in the WORK and which meet the requirements of the Contract Documents. The value of work performed and the cost of materials and equipment delivered to the site, as mentioned above, shall be determined by the ENGINEER in accordance with the procedure prescribed for the making of the final application for payment and payment under Paragraphs 14.8 and 14.9.

- 15.4 **TERMINATION OF AGREEMENT BY CONTRACTOR.** The CONTRACTOR may terminate the Agreement upon 10 days written notice to the OWNER, whenever: 1) the WORK has been suspended under the provisions of Paragraph 15.1, herein, for more than 90 consecutive days through no fault or negligence of the CONTRACTOR, and notice to resume work or to terminate the Agreement has not been received from the OWNER within this time period; or, 2) the OWNER should fail to pay the CONTRACTOR any monies due him in accordance with the terms of the Contract Documents and within 60 days after presentation to the OWNER by the CONTRACTOR of a request therefor, unless within said 10-day period the OWNER shall have remedied the condition upon which the payment delay was based. In the event of such termination, the CONTRACTOR shall have no claims against the OWNER except for those claims specifically enumerated in Paragraph 15.3, herein, and as determined in accordance with the requirements of said paragraph.

## ARTICLE 16 MISCELLANEOUS

- 16.1 **GIVING NOTICE.** Whenever any provision of the Contract Documents requires the giving of written notice, it will be deemed to have been validly given if delivered in person to the individual or to a member of the firm or to an officer of the corporation for whom it is intended, or if delivered at or sent by registered or certified mail, postage prepaid, to the last business address known to the giver of the notice.

### 16.2 RIGHTS IN AND USE OF MATERIALS FOUND ON THE WORK

- A. The CONTRACTOR may use on the Project, with ENGINEER's approval, such stone, gravel, sand, or other material determined suitable by the ENGINEER, as may be found in the excavation. The CONTRACTOR will be paid for the excavation of such material at the corresponding contract unit price. No additional payment will be made for utilizing the material from excavation as borrow, or select borrow.
- B. The CONTRACTOR shall replace, at its own expense, with other acceptable material, all of that portion of the excavated material so removed and used which was needed for use on the project. No charge for the materials so used will be made against the CONTRACTOR except that the CONTRACTOR shall be responsible for payment of any royalties required.
- C. The CONTRACTOR shall not excavate or remove any material from within the Project location which is not within the grading limits, as indicated by the slope and grade lines, without written authorization from the ENGINEER.
- D. In the event the CONTRACTOR has processed materials from OWNER-furnished sources in excess of the quantities required for performance of this contract, including any waste material produced as a by-product, the CBJ may retain possession of such materials without obligation to reimburse the CONTRACTOR for the cost of their production. When such

## SECTION 00700 - GENERAL CONDITIONS

materials are in a stockpile, the ENGINEER may require: That it remain in stockpile; the CONTRACTOR level such stockpile(s); or that the CONTRACTOR remove such materials and restore the premises to a satisfactory condition at the CONTRACTOR's expense. This provision shall not preclude the CBJ from arranging with the CONTRACTOR to produce material over and above the contract needs, payment for which shall be by written agreement between the CBJ and the CONTRACTOR.

- E. Unless otherwise provided, the material from any existing old structure may be used temporarily by the CONTRACTOR in the erection of the new structure. Such material shall not be cut or otherwise damaged except with the approval of the ENGINEER.
- 16.3 **RIGHT TO AUDIT.** If the CONTRACTOR submits a claim to the OWNER for additional compensation, the OWNER shall have the right, as a condition to considering the claim, and as a basis for evaluation of the claim, and until the claim has been settled, to audit the CONTRACTOR's books to the extent they are relevant. This right shall include the right to examine books, records, documents, and other evidence and accounting procedures and practices, sufficient to discover and verify all direct and indirect costs of whatever nature claimed to have been incurred or anticipated to be incurred and for which the claim has been submitted. The right to audit shall include the right to inspect the CONTRACTOR's plants, or such parts thereof, as may be or have been engaged in the performance of the WORK. The CONTRACTOR further agrees that the right to audit encompasses all subcontracts and is binding upon Subcontractors. The rights to examine and inspect herein provided for shall be exercisable through such representatives as the OWNER deems desirable during the CONTRACTOR's normal business hours at the office of the CONTRACTOR. The CONTRACTOR shall make available to the OWNER for auditing, all relevant accounting records and documents, and other financial data, and upon request, shall submit true copies of requested records to the OWNER.
- 16.4 **ARCHEOLOGICAL OR HISTORICAL DISCOVERIES.** When the CONTRACTOR's operation encounters prehistoric artifacts, burials, remains of dwelling sites, paleontological remains, such as shell heaps, land or sea mammal bones or tusks, or other items of historical significance, the CONTRACTOR shall cease operations immediately and notify the ENGINEER. No artifacts or specimens shall be further disturbed or removed from the ground and no further operations shall be performed at the site until so directed. Should the ENGINEER order suspension of the CONTRACTOR's operations in order to protect an archaeological or historical finding, or order the CONTRACTOR to perform extra work, such order(s) shall be covered by an appropriate contract change document.
- 16.5 **CONSTRUCTION OVER OR ADJACENT TO NAVIGABLE WATERS.** All work over, on, or adjacent to navigable waters shall be so conducted that free navigation of the waterways will not be interfered with and the existing navigable depths will not be impaired, except as allowed by permit issued the U.S. Coast Guard and/or the U.S. Army Corps of Engineers, as applicable.
- 16.6 **GRATUITY AND CONFLICT OF INTEREST.** The CONTRACTOR agrees to not extend any loan, gratuity or gift of money of any form whatsoever to any employee or elected official of the OWNER, nor will the CONTRACTOR rent or purchase any equipment or materials from any employee or elected official of the OWNER, or to the best of the CONTRACTOR's knowledge, from any agent of any employee or elected official of the OWNER. Before final payment, the CONTRACTOR shall execute and furnish the OWNER an affidavit certifying that the CONTRACTOR has complied with the above provisions of the contract.



## SECTION 00700 - GENERAL CONDITIONS

### 16.7 SUITS OF LAW CONCERNING THE WORK

- A. Should a suit of law be entered into, either by the CONTRACTOR (or the CONTRACTOR's surety) against the OWNER, or by the OWNER against the CONTRACTOR (or the CONTRACTOR's surety), the suit of law shall be tried in the First Judicial District of Alaska.
- B. If one of the questions at issue is the satisfactory performance of the work by the CONTRACTOR and should the appropriate court of law judge the work of the CONTRACTOR to be unsatisfactory, then the CONTRACTOR (or the CONTRACTOR's surety) shall reimburse the OWNER for all legal and all other expenses (as may be allowed and set by the court) incurred by the OWNER because of the suit of the law and, further, it is agreed that the OWNER may deduct such expense from any sum or sums then, or any that become due the CONTRACTOR under the contract.

### 16.8 CERTIFIED PAYROLLS

- A. All CONTRACTORs or Subcontractor who perform work on a public construction contract for the OWNER shall file a certified payroll with the Alaska Department of Labor before Friday of each week that covers the preceding week (Section 14-2-4 ACLA 1949; am Section 4 ch 142 SLA 1972).
- B. In lieu of submitting the State payroll form, the CONTRACTOR's standard payroll form may be submitted, provided it contains the information required by AS 36.05.040 and a statement that the CONTRACTOR is complying with AS 36.10.010.
- C. A contractor or subcontractor, who performs work on public construction in the State, as defined by AS 36.95.010(3), shall pay not less than the current prevailing rate of wages as issued by the Alaska Department of Labor before the end of the pay period. (AS 36.05.010).

### 16.9 PREVAILING WAGE RATES

- A. Wage rates for Laborers and Mechanics on Public Contracts, AS 36.05.070. The CONTRACTOR, or Subcontractors, shall pay all employees unconditionally and not less than once a week. Wages may not be less than those stated in Paragraph 16.8C, regardless of the contractual relationship between the CONTRACTOR or Subcontractors and laborers, mechanics, or field surveyors. The scale of wages to be paid shall be posted by the CONTRACTOR in a prominent, easily accessible place at the site of the WORK.
- B. Failure to Pay Agreed Wages, AS 36.05.080. If it is found that a laborer, mechanic, or field surveyor employed by the CONTRACTOR or Subcontractor has been, or is being, paid a rate or wages less than the established rate, the OWNER may, by written notice, terminate the CONTRACTOR or Subcontractors right to proceed with the work. The OWNER may prosecute the work to completion by contract or otherwise, and the CONTRACTOR and sureties will be held liable to the OWNER for excess costs for completing the WORK. (Section 2 ch 52 SLA 1959).
- C. Listing Contractor's Who Violate Contracts, AS 36.05.090. In addition, a list giving the names of persons who have disregarded the rights of their employees shall be distributed to all departments of State government and all political subdivisions. No person appearing on this

## SECTION 00700 - GENERAL CONDITIONS

list, and no firm, corporation, partnership or association in which the person has an interest, may work as a CONTRACTOR or Subcontractor on a public construction contract for the State, or a political subdivision of the state, until three years after the date of publication of the list. (Section 3 ch 52 SLA 1959; am Section 9 ch 142 SLA).

16.10 EMPLOYMENT REFERENCE. Workers employed in the execution of the contract by the CONTRACTOR or by any Subcontractor under this contract shall not be required or permitted to labor more than 8 hours a day or 40 hours per week in violation of the provisions of the Alaska Wage and Hour Act, Section 23.10.060.

16.11 COST REDUCTION INCENTIVE

- A. At any time within 45 days after the date of the Notice of Award, the CONTRACTOR may submit to the ENGINEER in writing, proposals for modifying the plans, specifications, or other requirements of this contract for the sole purpose of reducing the total cost of construction. The cost reduction proposal shall not impair in any manner the essential functions or characteristics of the project, including but not limited to, service life, economy of operation, ease of maintenance, desired appearance or design and safety standards.
- B. The cost reduction proposal shall contain the following information:
  - 1. Description of both the existing contract requirements for performing the WORK and the proposed changes.
  - 2. An itemization of the contract requirements that must be changed if the proposal is adopted.
  - 3. A detailed estimate of the time required and the cost of performing the WORK under both the existing contract and the proposed change.
  - 4. A statement of the date by which the CONTRACTOR must receive the decision from the OWNER on the cost reduction proposal.
  - 5. The contract items of WORK effected by the proposed changes including any quantity variations.
  - 6. A description and estimate of costs the OWNER may incur in implementing the proposed changes, such as test and evaluation and operating and support costs.
  - 7. A prediction of any effects the proposed change would have on future operations and maintenance costs to the OWNER.
- C. The provisions of this section shall not be construed to require the OWNER to consider any cost reduction proposal which may be submitted; nor will the OWNER be liable to the CONTRACTOR for failure to accept or act upon any cost reduction proposal submitted, or for delays to the work attributable to the consideration or implementation of any such proposal.
- D. If a cost reduction proposal is similar to a change in the plans or specifications for the project under consideration by the OWNER at the time the proposal is submitted, the OWNER will not accept such proposal and reserves the right to make such changes without compensation to the CONTRACTOR under the provisions of this section.
- E. The CONTRACTOR shall continue to perform the work in accordance with the requirements of the contract until an executed Change Order incorporating the cost reduction proposal has

## SECTION 00700 - GENERAL CONDITIONS

been issued. If any executed Change Order has not been issued by the date upon which the CONTRACTOR's cost reduction proposal specifies that a decision should be made by the OWNER, in writing, the cost reduction proposal shall be considered rejected.

- F. The OWNER, shall be the sole judge of the acceptability of a cost reduction proposal and of the estimated net savings in Contract Time and construction costs resulting from the adoption of all or any part of such proposal. Should the CONTRACTOR disagree with OWNER's decision on the cost reduction proposal, there is no further consideration. The OWNER reserves the right to make final determination.
- G. If the CONTRACTOR's cost reduction proposal is accepted in whole or in part, such acceptance will be made by a contract Change Order, which specifically states that the change is executed pursuant to this cost reduction proposal section. Such Change Order shall incorporate the changes in the plans and specifications which are necessary to permit the cost reduction proposal or such part of it as has been accepted to be put into effect and shall include any conditions upon which the OWNER's approval is based, if such approval is conditional. The Change Order shall also describe the estimated net savings in the cost of performing the work attributable to the cost reduction proposal, and shall further provide that the contract cost be adjusted by crediting the OWNER with the estimated net savings amount.
- H. Acceptance of the cost reduction proposal and performance of the work does not extend the time of completion of the contract, unless specifically provided in the Change Order authorizing the use of the submitted proposal. Should the adoption of the cost reduction proposal result in a Contract Time savings, the total Contract Time shall be reduced by an amount equal to the time savings realized.
- I. The amount specified to the CONTRACTOR in the Change Order accepted in the cost reduction proposal shall constitute full compensation for the performance of WORK. No claims for additional costs as a result of the changes specified in the cost reduction proposal shall be allowed.
- J. The OWNER reserves the right to adopt and utilize any approved cost reduction proposal for general use on any contract administered when it is determined suitable for such application. Cost reduction proposals identical, similar, or previously submitted will not be accepted for consideration if acceptance and compensation has previously been approved. The OWNER reserves the right to use all or part of any cost reduction proposal without obligation or compensation of any kind to the CONTRACTOR.
- K. The CONTRACTOR shall bear the costs, if any, to revise all bonds and insurance requirements for the project, to include the cost reduction WORK.

**END OF SECTION**

## SECTION 00800 - SUPPLEMENTARY GENERAL CONDITIONS

**GENERAL.** These Supplementary General Conditions make additions, deletions, or revisions to the General Conditions as indicated herein. All provisions which are not so added, deleted, or revised remain in full force and effect. Terms used in these Supplementary General Conditions which are defined in the General Conditions have the meanings assigned to them in the General Conditions.

**SGC 1 DEFINITIONS.** *Remove* the definition for Contract Documents and *replace* with the following:

Contract Documents – The Table of Contents, Notice Inviting Bids, Instructions to Bidders, Bid Forms (including the Bid, Bid Schedule(s), Subcontractor Report, Bid Bond, and all required certificates and affidavits), Agreement, Performance Bond, Payment Bond, General Conditions, Supplementary General Conditions, Alaska Labor Standards, Reporting, and Prevailing Wage Rate Determination, Special Provisions, Standard Specifications, Technical Specifications, Drawings, Permits, and all Addenda, and Change Orders executed pursuant to the provisions of the Contract Documents.

**SGC 2.2 COPIES OF DOCUMENTS.** *Add* the following:

The OWNER shall furnish to the CONTRACTOR two (2) hard copies of the Contract Documents which will include bound reduced Drawings and one (1) electronic copy (pdf format) on a CD-ROM. Additional copies of contract documents are the responsibility of the contractor.

**SGC 3.2 ORDER OF PRECEDENCE OF CONTRACT DOCUMENTS.** *Remove* No. 12. Technical Specifications and No. 13. Drawings, and *add* the following:

12. Special Provisions Section
13. Standard Specifications for Civil Engineering Projects and Subdivision Improvements  
December 2003 Edition with current Errata Sheets.
14. Drawings.

**SGC 4.2 PHYSICAL CONDITIONS - SUBSURFACE AND EXISTING STRUCTURES.** *Add* the following:

- C. In the preparation of the Contract Documents, the Engineer of Record has relied upon field measurements and visual inspection of the existing structures and surface conditions.

**SGC - 4.6 USE OF THE CBJ/STATE LEMON CREEK GRAVEL PIT.** *Add* the following.

**The CBJ/State Lemon Creek Gravel Pit is not available for this Project.**

**SGC 4.7 USE OF CITY/STATE STABLER'S POINT ROCK QUARRY.** *Add* the following:

**The CBJ/State Stabler's Point Rock Quarry is not available for this Project.**

**SGC 5.1 PERFORMANCE, PAYMENT, AND OTHER BONDS.** The Contractor shall furnish Performance and Payment Bonds in the amount of 100% of the Bid.

**SGC 5.2 INSURANCE AMOUNTS.** The limits of liability for the insurance required by Paragraph 5.2 of the General Conditions shall provide coverage for not less than the following amounts or greater where required by Laws and Regulations. The CONTRACTOR must provide certification of proper insurance coverage and amendatory endorsements or copies of the applicable policy language affecting coverage required in this agreement to the City and Borough of Juneau. All certificates of insurance supplied to the OWNER shall state that the OWNER is named as **“Additional Insured for any and all work performed for the City**

**SECTION 00800 - SUPPLEMENTARY GENERAL CONDITIONS**

**& Borough of Juneau” for the Commercial General Liability policy and any other policies, if required in this Section.** NOTE: This requirement has changed. The OWNER no longer requires certificates of insurance referencing project names and contract numbers.

*Delete* paragraph C and *Replace* with the following paragraph C:

- C. The CONTRACTOR shall furnish the OWNER with certificates showing the type, amount, class of operations covered, effective dates and dates of expiration of policies. Failure of CBJ to demand such certificate or other evidence of full compliance with these insurance requirements or failure of CBJ to identify a deficiency from evidence that is provided shall not be construed as a waiver of the obligation of the Contractor to maintain the insurance required by this contract. The coverage afforded will not be cancelled, reduced in coverage, or renewal refused until at least 30 days' prior written notice has been given to the OWNER by the CONTRACTOR. **All such insurance required herein (except for Workers’ Compensation and Employer's Liability) shall name the OWNER, its Consultants and subconsultants and their officers, directors, agents, and employees as "additional insureds" under the policies.**

The CONTRACTOR shall purchase and maintain the following insurance:

- 1. Workers’ Compensation and Employer’s Liability. This insurance shall protect the CONTRACTOR against all claims under applicable state workers’ compensation laws. The CONTRACTOR shall also be protected against claims for injury, disease, or death of employees which, for any reason, may not fall within the provisions of a Workers’ Compensation law. The CONTRACTOR shall require each Subcontractor similarly to provide Workers’ Compensation Insurance for all of the latter's employees to be engaged in such work unless such employees are covered by the protection afforded by the CONTRACTOR's Workers’ Compensation Insurance. In case any class of employees is not protected, under the Workers’ Compensation Statute, the CONTRACTOR shall provide and shall cause each subcontractor to provide adequate employer's liability insurance for the protection of such of its employees as are not otherwise protected. **The CONTRACTOR grants a waiver of any right to subrogation against the OWNER by virtue of the payment of any loss under such insurance.** This provision applies regardless of whether or not the OWNER has received a waiver of subrogation endorsement from the insurer.

Workers’ Compensation: (under Paragraph 5.2C.1 of the General Conditions) as in accordance with AS 23.30.045:

- a. State: Statutory
- b. Applicable Federal (e.g., Longshore): Statutory

Note: If the WORK called for in the Contract Documents involves work in or on any navigable waters, the CONTRACTOR shall provide Workers’ Compensation coverage which shall include coverage under the Longshore and Harbor Workers’ Compensation Act, the Jones Act, and any other coverage required under Federal or State laws pertaining to workers in or on navigable waters.

- a. Employers Liability
  - Bodily Injury by Accident: \$100,000.00 Each Accident
  - Bodily Injury by Disease: \$100,000.00 Each Employee
  - Bodily Injury by Disease: \$500,000.00 Policy Limit

**SECTION 00800 - SUPPLEMENTARY GENERAL CONDITIONS**

1. CONTRACTOR agrees to waive all rights of subrogation against the OWNER for WORK performed under contract.
2. If CONTRACTOR directly utilizes labor outside of the State of Alaska in the prosecution of the WORK, "Other States" endorsement shall be required as a condition of the contract.
2. Commercial General Liability (CGL), including products and completed operations, property damage, bodily injury and personal and advertising injury, with limits no less than \$1,000,000 each occurrence and \$2,000,000 aggregate. (under Paragraph 5.2C.2 of the General Conditions) **This insurance policy is to contain, or be endorsed to contain, additional insured status for the CBJ, its officers, officials, employees, and volunteers.** If Additional insured status is provided in the form of an endorsement to the Contractor's insurance, the endorsement shall be at least as broad as ISO Form CG 20 10 11 85 or **both** CG 20 10, CG 20 26, CG 20 33, or CG 20 38; **and** CG 20 37 forms if later revisions used).
3. Commercial Automobile Liability: (under Paragraph 5.2C.3 of the General Conditions) including Owned, Hired, and Non-Owned Vehicles:

Combined Single Limit, Bodily Injury and Property Damage                      \$1,000,000.00

**This insurance policy is to contain, or be endorsed to contain, additional insured status for the CBJ, its officers, officials, employees, and volunteers** The CONTRACTOR shall require each Subcontractor similarly to provide Commercial Automobile Liability Insurance for all of the latter's employees to be engaged in such WORK unless such employees are covered by the protection afforded by the CONTRACTOR's Commercial Automobile Liability Insurance.

*Add* the following paragraphs:

- C. Builder's Risk: CONTRACTOR is not required to obtain a Builder's Risk insurance policy for this project.
- D. All Subcontractors are required to secure and maintain the insurance coverages listed above, unless otherwise noted.
- E. If the CONTRACTOR maintains higher limits than the minimums shown above, the OWNER requires and shall be entitled to coverage for the higher limits maintained by the CONTRACTOR. Any available insurance proceeds in excess of the specified minimum limits of insurance and coverage shall be available to the OWNER.
- F. Policies shall also specify insurance provided by CONTRACTOR will be considered primary and not contributory to any other insurance available to the OWNER.
- G. Should any of the policies described above be cancelled before the expiration date thereof, notice will be delivered in accordance with the policy provisions.

**SGC 6.5 CONCERNING SUBCONTRACTORS, SUPPLIERS, AND OTHERS.** *Add* the following:

## SECTION 00800 - SUPPLEMENTARY GENERAL CONDITIONS

B. The CONTRACTOR shall perform not less than 40% of the WORK with its own forces (i.e., without subcontracting). The 40% requirement shall be understood to mean that the CONTRACTOR shall perform, with its own organization, WORK amounting to at least 40% of the original contract amount. The 40% requirement will be calculated based upon the total of the subcontract amounts submitted for Contract Award, and any other information requested by the OWNER from the apparent low Bidder.

**SGC 6.5 CONCERNING SUBCONTRACTORS, SUPPLIERS, AND OTHERS,** *Add* the following paragraph:

C. CONTRACTOR must pay Subcontractors and/or Suppliers within 30 days of receiving payment from the OWNER, if that payment was made for Work performed by the Subcontractor and/or materials received. Failure to pay Subcontractors within 30 days of receiving payment from which Subcontractor and/or Supplier is to be paid may result in the OWNER initiating debarment proceedings as prescribed in the City and Borough of Juneau Purchasing Code. *The 30 day City and Borough of Juneau requirement does not supersede AS 36.90.210.*

**SGC 6.6 PERMITS,** *Add* the following paragraph:

D. Contractor is responsible for obtaining a Hot Works permit from the CBJ Permit Center, if performing work which requires such a permit. Work requiring a Hot Works Permit includes but is not limited to the following: cutting, welding, Thermit welding, brazing, soldering, grinding, thermal spraying, thawing pipe, installation of torch-applied roof systems or any other similar activity.

**SGC 14.3 APPLICATION FOR PROGRESS PAYMENT.** Paragraph D.

D. The Value of Materials Stored at the site shall be an amount equal to 85%.

**SGC 14.9 FINAL PAYMENT AND ACCEPTANCE.** *Add* the following paragraph:

C. Prior to the final payment the CONTRACTOR shall contact the Alaska Department of Labor and Workforce Development (ADOL) and provide the OWNER with clearance from the ADOL for the CONTRACTOR and all Subcontractors that have worked on the Project. This clearance shall indicate that all Employment Security Taxes have been paid. A sample form for this purpose is at the end of this section. The CONTRACTOR shall also submit a "NOTICE OF COMPLETION OF PUBLIC WORKS" signed by ADOL.

**SGC 16.8 CERTIFIED PAYROLLS.** *Change* paragraph A. to read:

A. All CONTRACTORS or Subcontractors who perform work on a public construction contract for the OWNER shall file a certified payroll with Alaska Department of Labor. See Section 00830 - Alaska Labor Standards, Reporting, and Prevailing Wage Rate Determination.

*Add* the following SGC 17:

**SGC 17 GENERAL INFORMATION.** This Project is currently funded by the City and Borough of Juneau, Alaska.

**END OF SECTION**



### Tax Clearance Request Form for Contractors

Date of request: \_\_\_\_\_

Business name of the contractor a Tax Clearance is being requested for: \_\_\_\_\_

\_\_\_\_\_

Business address: \_\_\_\_\_

Business contact phone number: \_\_\_\_\_

Federal Identification Number: \_\_\_\_\_

Alaska Employer Account Number: \_\_\_\_\_

Specific time period a tax clearance is being requested for (*i.e. beginning and ending date of a subcontract agreement*):

\_\_\_\_\_

Subcontract project name: \_\_\_\_\_

\_\_\_\_\_

Name and address of the person this Tax Clearance is to be returned to: \_\_\_\_\_

\_\_\_\_\_

Comments or additional information: \_\_\_\_\_

\_\_\_\_\_

For agency use only:

- Tax Clearance is granted
- Tax Clearance is not granted (*please have employer contact the department*)
- No account on file, liability unknown (*please have employer contact the department*)
- Employer has stated no employees, Tax Clearance not required.

Agency representative signature: \_\_\_\_\_ Date: \_\_\_\_\_

Agency representative title: \_\_\_\_\_



**SECTION 00830 - ALASKA LABOR STANDARDS, REPORTING, AND  
PREVAILING WAGE RATE DETERMINATION**

State of Alaska, Department of Labor, Laborers' and Mechanics' Minimum Rates of Pay, AS 36.05.010 and AS 36.05.050, Wage and Hour Administration Pamphlet No. 600, the latest edition published by the State of Alaska, Department of Labor inclusive, are made a part of this contract by reference.

The CONTRACTOR is responsible for contacting the Alaska Department of Labor to determine compliance with current regulations.

Correspondence regarding Title 36 requirements may be submitted electronically or paper copies can be submitted by mail. To submit Title 36 documents electronically, go to <https://myalaska.state.ak.us/home/app>. If filing electronically, submit certified payrolls to ADOL at the website above and email a copy of all certified payrolls to Greg Smith at the email address below. If Contractor elects to submit paper copies, they should be submitted to the physical addresses below.

**Within 10 Days of "Notice of Award/Notice to Proceed"** make a list of **all** Subcontractors. Include their name, address, phone, estimated subcontract amount, and estimated start and finish dates. Send this list to the Wage and Hour Section (contact information below).

**Certified Payrolls must be submitted every two weeks. Before the second Friday**, each CONTRACTOR and Subcontractor must file Certified Payrolls with Statements of Compliance for the previous two weeks. Indicate "**Start**" on your first payroll, and "**Final**" on your last payroll for this Project.

As part of the **final payment request package**, CONTRACTOR must submit a "NOTICE OF COMPLETION OF PUBLIC WORKS" form signed by ADOL personnel.

**Contact Information:**

*Wage and Hour Section*  
State of Alaska  
Department of Labor and Workforce Development  
Labor Standards and Safety Division                      and  
Wage and Hour Administration  
P.O. Box 11149  
Juneau, AK 99811-1149  
907-465-4842  
<http://labor.state.ak.us/lss/home.htm>

*Greg Smith, Contract Administrator*  
City and Borough of Juneau  
155 S. Seward Street  
Juneau, AK 99801  
(907) 586-0873  
[Greg.Smith@juneau.org](mailto:Greg.Smith@juneau.org)

**END OF SECTION**

# SECTION 00830

## APPENDIX A

Laborers' & Mechanics'  
Minimum Rates of Pay

Pamphlet 600

Effective September 1, 2020

A large-scale construction project is shown, featuring a concrete bridge structure supported by several pillars in a wide river. An orange aerial lift is positioned on the bridge deck, with a worker visible on it. The background includes a rocky embankment, a construction yard with various vehicles and equipment, and a line of trees under a cloudy sky.

# Laborers' and Mechanics' MINIMUM RATES OF PAY

Effective September 1, 2020

Issue 41

**PAMPHLET No. 600**

Title 36. Public Contracts

AS 36.05

**DEPARTMENT OF LABOR  
AND WORKFORCE DEVELOPMENT**

Wage and Hour Administration

- This page intentionally left blank -



September 1, 2020

**TO ALL CONTRACTING AGENCIES:**

At the Alaska Department of Labor and Workforce Development, our goal is putting Alaskans to work. This pamphlet is designed to help contractors awarded public construction contracts understand the most significant laws of the State of Alaska pertaining to prevailing wage.

This pamphlet identifies current prevailing wage rates for public construction contracts (any construction projects awarded for the State of Alaska or its political subdivisions, such as local governments and certain non-profit organizations). Because these rates may change in a subsequent determination, please be sure you are using the appropriate rates. The rates published in this edition become effective September 1, 2020.

The prevailing wage rates contained in this pamphlet are applicable to public construction projects with a final bid date of September 11, 2020, or later. As the law now provides, these rates will remain stable during the life of a contract or for 24 calendar months, whichever is shorter. **The 24-month period begins on the date the prime contract is awarded.** Upon expiration of the initial 24-month period, the latest wage rates issued by the department shall become effective for a subsequent 24-month period or until the original contract is completed, whichever occurs first. This process shall be repeated until the original contract is completed.

The term "original contract" means the signed contract that resulted from the original bid and any amendments, including changes of work scope, additions, extensions, change orders, and other instruments agreed to by the parties that have not been subject to subsequent open bid procedures.

If a higher federal rate is required due to partial federal funding or other federal participation, the higher rate must be paid.

For additional copies of this pamphlet go to: <http://labor.state.ak.us/lss/pamp600.htm>

For questions regarding prevailing wage or employment preference requirements, please contact the nearest Wage and Hour office. These offices are listed on Page x.

Sincerely,

A handwritten signature in black ink that reads "Tamika L. Ledbetter".

Dr. Tamika L. Ledbetter  
Commissioner

- This page intentionally left blank -

# Table of Contents

## Excerpts from Alaska Law

Sec. 36.05.005. Applicability.....	iv
Sec. 36.05.010. Wage rates on public construction. ....	iv
Sec. 36.05.040. Filing schedule of employees, wages paid and other information .....	iv
Sec. 36.05.045. Notice of work and completion; withholding of payment .....	iv
Sec. 36.05.060. Penalty for violation of this chapter .....	v
Sec. 36.05.070. Wage rates in specifications and contracts for public works .....	v
Sec. 36.05.080. Failure to pay agreed wages.....	v
Sec. 36.05.090. Payment of wages from withheld payments and listing contractors who violate contracts .....	v
Sec. 36.05.900. Definition.. ..	vi

## Excerpts from Alaska Administrative Code

8 AAC 30.051. Purpose .....	vi
8 AAC 30.052. Board and lodging; remote sites .....	vi
8 AAC 30.054. Per diem instead of board and lodging .....	vi
8 AAC 30.056. Alternative arrangement .....	vii
8 AAC 30.900. General definitions (selected excerpts).....	vii

## Additional Information

Per Diem .....	vii
Laborer Classification Clarification.....	viii
Apprentice Rates.....	viii
Fringe Benefit Plans.....	viii
Special Prevailing Wage Rate Determination.....	ix
Alaska Employment Preference Information.....	ix
Labor Standards and Safety Notice Requests .....	x
Debarment List .....	x

## Wage Rates ..... Pages 1-26

**Note to Readers:** The statutes and administrative regulations listed in this publication were taken from the official codes, as of the effective date of the publication. However, there may be errors or omissions that have not been identified and changes that occurred after the publication was printed. This publication is intended as an informational guide only and is not intended to serve as a precise statement of the statutes and regulations of the State of Alaska. To be certain of current laws and regulations, please refer to the official codes.

## EXCERPTS FROM ALASKA LAW

### **Sec. 36.05.005. Applicability.**

This chapter applies only to a public construction contract that exceeds \$25,000.

### **Sec. 36.05.010. Wage rates on public construction.**

A contractor or subcontractor who performs work on a public construction contract in the state shall pay not less than the current prevailing rate of wages for work of a similar nature in the region in which the work is done. The current prevailing rate of wages is that contained in the latest determination of prevailing rate of wages issued by the Department of Labor and Workforce Development at least 10 days before the final date for submission of bids for the contract. The rate shall remain in effect for the life of the contract or for 24 calendar months, whichever is shorter. At the end of the initial 24-month period, if new wage determinations have been issued by the department, the latest wage determination shall become effective for the next 24-month period or until the contract is completed, whichever occurs first. This process shall be repeated until the contract is completed.

### **Sec. 36.05.040. Filing schedule of employees, wages paid, and other information.**

All contractors or subcontractors who perform work on a public construction contract for the state or for a political subdivision of the state shall, before the Friday of every second week, file with the Department of Labor and Workforce Development a sworn affidavit for the previous reporting period, setting out in detail the number of persons employed, wages paid, job classification of each employee, hours worked each day and week, and other information on a form provided by the Department of Labor and Workforce Development.

### **Sec. 36.05.045. Notice of work and completion; withholding of payment.**

- (a) Before commencing work on a public construction contract, the person entering into the contract with a contracting agency shall designate a primary contractor for purposes of this section. Before work commences, the primary contractor shall file a notice of work with the Department of Labor and Workforce Development. The notice of work must list work to be performed under the public construction contract by each contractor who will perform any portion of work on the contract and the contract price being paid to each contractor. The primary contractor shall pay all filing fees for each contractor performing work on the contract, including a filing fee based on the contract price being paid for work performed by the primary contractor's employees. The filing fee payable shall be the sum of all fees calculated for each contractor. The filing fee shall be one percent of each contractor's contract price. The total filing fee payable by the primary contractor under this subsection may not exceed \$5,000. In this subsection, "contractor" means an employer who is using employees to perform work on the public construction contract under the contract or a subcontract.
- (b) Upon completion of all work on the public construction contract, the primary contractor shall file with the Department of Labor and Workforce Development a notice of completion together with payment of any additional filing fees owed due to increased contract amounts. Within 30 days after the department's receipt of the primary contractor's notice of completion, the department shall inform the contracting agency of the amount, if any, to be withheld from the final payment.
- (c) A contracting agency
  - (1) may release final payment of a public construction contract to the extent that the agency has received verification from the Department of Labor and Workforce Development that
    - (A) the primary contractor has complied with (a) and (b) of this section;
    - (B) the Department of Labor and Workforce Development is not conducting an investigation under this title; and
    - (C) the Department of Labor and Workforce Development has not issued a notice of a violation of this chapter to the primary contractor or any other contractors working on the public construction contract; and



- (2) shall withhold from the final payment an amount sufficient to pay the department's estimate of what may be needed to compensate the employees of any contractors under investigation on this construction contract, and any unpaid filing fees.
- (d) The notice and filing fee required under (a) of this section may be filed after work has begun if
  - (1) The public construction contract is for work undertaken in immediate response to an emergency; and
  - (2) The notice and fees are filed not later than 14 days after the work has begun.
- (e) A false statement made on a notice required by this section is punishable under AS 11.56.210.

**Sec. 36.05.060. Penalty for violation of this chapter.**

A contractor who violates this chapter is guilty of a misdemeanor and upon conviction is punishable by a fine of not less than \$100 nor more than \$1,000, or by imprisonment for not less than 10 days nor more than 90 days, or by both. Each day a violation exists constitutes a separate offense.

**Sec. 36.05.070. Wage rates in specifications and contracts for public works.**

- (a) The advertised specifications for a public construction contract that requires or involves the employment of mechanics, laborers, or field surveyors must contain a provision stating the minimum wages to be paid various classes of laborers, mechanics, or field surveyors and that the rate of wages shall be adjusted to the wage rate under AS 36.05.010.
- (b) Repealed by §17 ch 142 SLA 1972.
- (c) A public construction contract under (a) of this section must contain provisions that
  - (1) the contractor or subcontractors of the contractor shall pay all employees unconditionally and not less than once a week;
  - (2) wages may not be less than those stated in the advertised specifications, regardless of the contractual relationship between the contractor or subcontractors and laborers, mechanics, or field surveyors;
  - (3) the scale of wages to be paid shall be posted by the contractor in a prominent and easily accessible place at the site of the work;
  - (4) the state or a political subdivision shall withhold so much of the accrued payments as is necessary to pay to laborers, mechanics, or field surveyors employed by the contractor or subcontractors the difference between
    - (A) the rates of wages required by the contract to be paid laborers, mechanics, or field surveyors on the work; and
    - (B) the rates of wages in fact received by laborers, mechanics, or field surveyors.

**Sec. 36.05.080. Failure to pay agreed wages.**

Every contract within the scope of AS 36.05.070 shall contain a provision that if it is found that a laborer, mechanic, or field surveyor employed by the contractor or subcontractor has been or is being paid a rate of wages less than the rate of wages required by the contract to be paid, the state or its political subdivision may, by written notice to the contractor, terminate the contractor's right to proceed with the work or the part of the work for which there is a failure to pay the required wages and to prosecute the work to completion by contract or otherwise, and the contractor and the contractor's sureties are liable to the state or its political subdivision for excess costs for completing the work.

**Sec. 36.05.090. Payment of wages from withheld payments and listing contractors who violate contracts.**

- (a) The state disbursing officer in the case of a state public construction contract and the local fiscal officer in the case of a political subdivision public construction contract shall pay directly to laborers, mechanics, or field surveyors from accrued payments withheld under the terms of the contract the wages due laborers, mechanics, or field surveyors under AS 36.05.070.
- (b) The state disbursing officer or the local fiscal officer shall distribute to all departments of the state government and to all political subdivisions of the state a list giving the names of persons who have disregarded their obligations to employees. A person appearing on this list and a firm, corporation, partnership, or association in which the person has an interest may not work as a contractor or

subcontractor on a public construction contract for the state or a political subdivision of the state until three years after the date of publication of the list. If the accrued payments withheld under the contract are insufficient to reimburse all the laborers, mechanics, or field surveyors with respect to whom there has been a failure to pay the wages required under AS 36.05.070, the laborers, mechanics, or field surveyors have the right of action or intervention or both against the contractor and the contractor's sureties conferred by law upon persons furnishing labor or materials, and in the proceedings it is not a defense that the laborers, mechanics, or field surveyors accepted or agreed to accept less than the required rate of wages or voluntarily made refunds.

**Sec. 36.05.900. Definition.**

In this chapter, "contracting agency" means the state or a political subdivision of the state that has entered into a public construction contract with a contractor.

**EXCERPTS FROM ALASKA ADMINISTRATIVE CODE**

\*\*\***Notice:** Regulations relating to board and lodging and per diem went into effect on November 25, 2018. The new regulations are excerpted here\*\*\*

**8 AAC 30.051. Purpose.** The purpose of 8 AAC 30.052 – 8 AAC 30.056 is to ensure that wages paid to laborers, mechanics, and field surveyors do not fall below the prevailing rate of pay.

**8 AAC 30.052. Board and lodging; remote sites.** (a) A contractor on a public construction project located 65 or more road miles from the international airport closest to the project area in either Fairbanks, Juneau, or Anchorage, or that is inaccessible by road in a two-wheel drive vehicle, shall provide adequate board and lodging to each laborer, mechanic, or field surveyor while the person is employed on the project. If commercial lodging facilities are not available, the contractor shall provide temporary lodging facilities. Lodging facilities must comply with all applicable state and federal laws. For a highway project, the location of the project is measured from the midpoint of the project.

(b) A contractor is not required to provide board and lodging:

(1) to a laborer, mechanic, or field surveyor who is a domiciled resident of the project area; or

(2) on a laborer, mechanic, or field surveyor's scheduled days off, when the person can reasonably travel between the project and the person's permanent residence; for the purposes of this paragraph, "scheduled day off" means a day in which a person does not perform work on-site, is not required to remain at or near the job location for the benefit of the contractor, and is informed of the day off at least seven days before the day off.

(c) Upon a contractor's written request, the commissioner may waive the requirements of (a) of this section where:

(1) the project is inaccessible by road in a two-wheel drive vehicle, but the laborer, mechanic, or field surveyor can reasonably travel between the project and the person's permanent residence within one hour; or

(2) a laborer, mechanic, or field surveyor is not a domiciled resident of the project area, but has established permanent residence, with the intent to remain indefinitely, within 65 road miles of the project, or for a highway project, the mid-point of the project.

**8 AAC 30.054. Per diem instead of board and lodging.** (a) A contractor may pay a laborer, mechanic, or field surveyor per diem instead of providing board and lodging, when the following conditions are met:

(1) the department determines that per diem instead of board and lodging is an established practice for the work classification; the department shall publish and periodically revise its determinations in the pamphlet *Laborers' and Mechanics' Minimum Rates of Pay*;

(2) the contractor pays each laborer, mechanic, or field surveyor the appropriate per diem rate as published and periodically revised in the pamphlet *Laborers' and Mechanics' Minimum Rates of Pay*; and

(3) the contractor pays the per diem to each laborer, mechanic, or field surveyor on the same day that wages are paid.

(b) A contractor may not pay per diem instead of board and lodging on a highway project located

- (1) west of Livengood on the Elliot Highway, AK-2;
- (2) on the Dalton Highway, AK-11;
- (3) north of milepost 20 on the Taylor Highway, AK-5;
- (4) east of Chicken on the Top of the World Highway; or
- (5) south of Tetlin Junction to the Alaska-Canada border on the Alaska Highway, AK-2.

**8 AAC 30.056. Alternative arrangement.** Upon a contractor’s written request, the commissioner may approve an alternative board and lodging or per diem arrangement, provided

- (1) the arrangement does not reduce the laborer, mechanic, or field surveyor’s wages below the prevailing wage rate; and
- (2) the laborer, mechanic, or field surveyor voluntarily enters into and signs the written arrangement; a labor organization representing laborers, mechanics, or field surveyors may enter into the written agreement on their behalf.

**8 AAC 30.900. General definitions** (selected excerpts only):

In this chapter and in AS 36

(22) “domiciled resident” means a person living within 65 road miles of a public construction project, or in the case of a highway project, the mid-point of the project, for at least 12 consecutive months prior to the award of the public construction project;

(23) “employed on the project” means the time period from the date the laborer, mechanic, or field surveyor first reports on-site to the project through the final date the person reports on-site to the project.

## **ADDITIONAL INFORMATION**

### **PER DIEM**

**Notice:** New regulations relating to board and lodging and per diem went into effect on November 25, 2018. The regulations provide a comprehensive set of requirements for the provision of board and lodging or per diem for workers on remote projects. Please refer to Alaska Administrative Code 8 AAC Chapter 30 and read the chapter carefully.

The Alaska Department of Labor and Workforce Development has determined that per diem is an established work practice for certain work classifications. These classifications are indicated throughout the Pamphlet by an asterisk (\*) under the classification title. If all of the conditions of 8 AAC 30.054 are met, an employer may pay workers in these classifications per diem instead of providing board and lodging on a remote project.

**Per Diem Rate:** As of May 1<sup>st</sup>, 2019, the minimum per diem rate is \$100.00 per day, or part thereof, the worker is employed on the project. In the event that a contractor provides lodging facilities, but no meals, the department will accept a payment of \$48 per day for meals to meet the per diem requirements.

### LABORER CLASSIFICATION CLARIFICATION

The laborer rates categorized in class code S1201-S1206 apply in one area of Alaska; the area that is south of N63 latitude and west of W138 Longitude. The laborer rates categorized in class code N1201-N1206 apply in two areas of Alaska; the Alaska areas north of N63 latitude and east of W138 longitude. The following graphic representations should assist with clarifying the applicable wage rate categories:

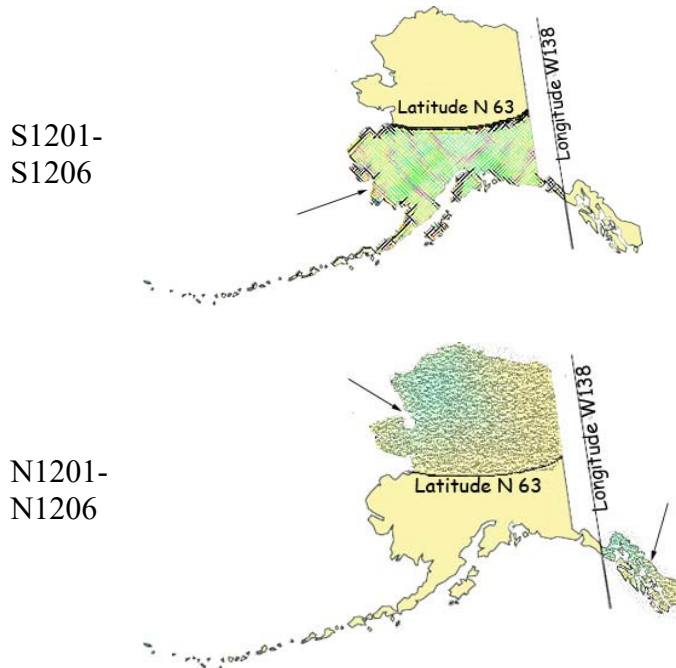

### APPRENTICE RATES

Apprentice rates at less than the minimum prevailing rates may be paid to apprentices according to an apprentice program which has been registered and approved by the Commissioner of the Alaska Department of Labor and Workforce Development in writing or according to a bona fide apprenticeship program registered with the U.S. Department of Labor, Office of Apprenticeship Training. **Any employee listed on a payroll at an apprentice wage rate who is not registered as above shall be paid the journeyman prevailing minimum wage in that work classification.** Wage rates are based on prevailing crew makeup practices in Alaska and apply to work performed regardless of either the quality of the work performed by the employee or the titles or classifications which may be assigned to individual employees.

### FRINGE BENEFIT PLANS

Contractors/subcontractors may compensate fringe benefits to their employees in any one of three methods. The fringe benefits may be paid into a union trust fund, into an approved benefit plan, or paid directly on the paycheck as gross wages.

Where fringe benefits are paid into approved plans, funds, or programs including union trust funds, the payments must be contributed at least monthly. If contractors submit their own payroll forms and are paying fringe benefits into approved plans, funds, or programs, the employer's certification must include, in addition to those requirements of 8 AAC 30.020(c), a statement that fringe benefit payments have been or will be paid at least monthly. Contractors who pay fringe benefits to a plan must ensure the plan is one approved by the Internal Revenue Service and that the plan meets the requirements of 8 AAC 30.025 (eff. 3/2/08) in order for payments to be credited toward the prevailing wage obligation.

**SPECIAL PREVAILING WAGE RATE DETERMINATION**

Special prevailing wage rate determinations may be requested for special projects or a special worker classification if the work to be performed does not conform to traditional public construction for which a prevailing wage rate has been established under 8 AAC 30.050(a) of this section. Requests for special wage rate determinations must be in writing and filed with the Commissioner at least 30 days before the award of the contract. An applicant for a special wage rate determination shall have the responsibility to support the necessity for the special rate. An application for a special wage rate determination filed under this section must contain:

- (1) a specification of the contract or project on which the special rates will apply and a description of the work to be performed;
- (2) a brief narrative explaining why special wage rates are necessary;
- (3) the job class or classes involved;
- (4) the special wage rates the applicant is requesting, including survey or other relevant wage data to support the requested rates;
- (5) the approximate number of employees who would be affected; and
- (6) any other information which might be helpful in determining if special wage rates are appropriate.

Requests made pursuant to the above should be addressed to:

Director  
Alaska Department of Labor and Workforce Development  
Labor Standards and Safety Division  
Wage and Hour Administration  
P.O. Box 111149  
Juneau, AK 99811-1149

-or-

Email: [statewide.wagehour@alaska.gov](mailto:statewide.wagehour@alaska.gov)

**EMPLOYMENT PREFERENCE INFORMATION**

In October 2019, the Alaska Attorney General issued a formal opinion stating that the Alaska Statutes 36.10.150 of the State’s 90% Employment Preference law, also known as the Alaska Resident Hire law, violates both the U.S. and Alaska Constitutions. As a result, the state has stopped all enforcement activity.

A copy of the Attorney General opinion is found here:

[http://law.alaska.gov/pdf/opinions/opinions\\_2019/19-005\\_AK-hire.pdf](http://law.alaska.gov/pdf/opinions/opinions_2019/19-005_AK-hire.pdf)

**Alaska Department of Labor and Workforce Development**  
**Labor Standards and Safety Division**  
**Wage and Hour Administration**  
Web site: <http://labor.state.ak.us/lss/pamp600.htm>

**Anchorage**

1251 Muldoon Road, Suite 113  
Anchorage, Alaska 99504-2098  
Phone: (907) 269-4900

Email:  
statewide.wagehour@alaska.gov

**Juneau**

PO Box 111149  
Juneau, Alaska 99811  
Phone: (907) 465-4842

Email:  
statewide.wagehour@alaska.gov

**Fairbanks**

Regional State Office Building  
675 7<sup>th</sup> Ave., Station J-1  
Fairbanks, Alaska 99701-4593  
Phone: (907) 451-2886

Email:  
statewide.wagehour@alaska.gov

**LABOR STANDARDS AND SAFETY NOTICE REQUESTS**

If you would like to receive Wage and Hour Administration or Mechanical Inspection **regulation notices** or **publications information**, they are available via electronic mail, by signing up in the GovDelivery System, <https://public.govdelivery.com/accounts/AKDOL/subscriber/new> and selecting topics *LSS – Wage and Hour – Forms and Publications*, *LSS – Mechanical Inspection Regulations*, or *LSS – Wage and Hour Regulations*.

*Publications* are also available online at <http://labor.alaska.gov/lss/home.htm>

**DEBARMENT LIST**

**AS 36.05.090(b)** states that “the state disbursing officer or the local fiscal officer shall distribute to all departments of the state government and to all political subdivisions of the state a list giving the names of persons who have disregarded their obligations to employees.”

A person appearing on the following debarment list and a firm, corporation, partnership, or association in which the person has an interest may not work as a contractor or subcontractor on a public construction contract for the state or a political subdivision of the state for three years from the date of debarment.

Company Name

Debarment Expires

Tim Banach, Individual  
Boulder Creek Electric

February 23, 2021  
February 23, 2021

# Laborers' & Mechanics' Minimum Rates of Pay

Class Code	Classification of Laborers & Mechanics	BHR	H&W	PEN	TRN	Other	Benefits	THR
------------	--	-----	-----	-----	-----	-------	----------	-----

## Boilermakers

\*See per diem note on last page

<b>A0101</b>	Boilermaker (journeyman)	46.08	8.57	16.72	1.65	VAC 3.50	SAF 0.34	76.86
--------------	--------------------------	-------	------	-------	------	----------	----------	-------

## Bricklayers & Blocklayers

\*See per diem note on last page

<b>A0201</b>	Blocklayer	42.16	9.00	10.05	0.62	L&M 0.20		62.03
--------------	------------	-------	------	-------	------	----------	--	-------

Bricklayer  
 Marble or Stone Mason  
 Refractory Worker (Firebrick, Plastic, Castable, and Gunitite Refractory Applications)  
 Terrazzo Worker  
 Tile Setter

<b>A0202</b>	Tuck Pointer Caulker	42.16	9.00	10.05	0.62	L&M 0.20		62.03
--------------	----------------------	-------	------	-------	------	----------	--	-------

Cleaner (PCC)

<b>A0203</b>	Marble & Tile Finisher	35.99	9.00	10.05	0.62	L&M 0.20		55.86
--------------	------------------------	-------	------	-------	------	----------	--	-------

Terrazzo Finisher

<b>A0204</b>	Torginal Applicator	40.10	9.83	8.50	0.55	L&M 0.15	0.87	60.00
--------------	---------------------	-------	------	------	------	----------	------	-------

## Carpenters, Region I (North of 63 latitude)

\*See per diem note on last page

<b>N0301</b>	Carpenter (journeyman)	38.34	10.08	15.23	1.10	L&M 0.10	SAF 0.10	64.95
--------------	------------------------	-------	-------	-------	------	----------	----------	-------

Lather/Drywall/Acoustical

## Carpenters, Region II (South of N63 latitude)

\*See per diem note on last page

<b>S0301</b>	Carpenter (journeyman)	38.34	10.08	15.77	1.10	L&M 0.10	SAF 0.10	65.49
--------------	------------------------	-------	-------	-------	------	----------	----------	-------

Lather/Drywall/Acoustical

## Cement Masons

\*See per diem note on last page

Wage benefits key: BHR=basic hourly rate; H&W=health and welfare; IAF=industry advancement fund; LEG=legal fund; L&M=labor/management fund; PEN=pens fund; SAF=safety; SUI=supplemental unemployment insurance; S&L=SUI & LEG combined; TRN=training; THR=total hourly rate; VAC=vacation

<b>Cement Masons</b>								
*See per diem note on last page								

<b>A0401</b>	Group I, including:	38.38	8.70	11.80	1.43		<b>L&amp;M</b> 0.10	60.41
	Application of Sealing Compound							
	Application of Underlayment							
	Building, General							
	Cement Mason (journeyman)							
	Concrete							
	Concrete Paving							
	Curb & Gutter, Sidewalk							
	Curing of All Concrete							
	Grouting & Caulking of Tilt-Up Panels							
	Grouting of All Plates							
	Patching Concrete							
	Screed Pin Setter							
	Spackling/Skim Coating							

<b>A0402</b>	Group II, including:	38.38	8.70	11.80	1.43		<b>L&amp;M</b> 0.10	60.41
	Form Setter							

<b>A0403</b>	Group III, including:	38.38	8.70	11.80	1.43		<b>L&amp;M</b> 0.10	60.41
	Concrete Saw (self-powered)							
	Curb & Gutter Machine							
	Floor Grinder							
	Pneumatic Power Tools							
	Power Chipping & Bushing							
	Sand Blasting Architectural Finish							
	Screed & Rodding Machine Operator							
	Troweling Machine Operator							

<b>A0404</b>	Group IV, including:	38.38	8.70	11.80	1.43		<b>L&amp;M</b> 0.10	60.41
	Application of All Composition Mastic							
	Application of All Epoxy Material							
	Application of All Plastic Material							
	Finish Colored Concrete							
	Guniting Nozzleman							
	Hand Powered Grinder							
	Tunnel Worker							

<b>A0405</b>	Group V, including:	38.38	8.70	11.80	1.43		<b>L&amp;M</b> 0.10	60.41
	Plasterer							

Wage benefits key: BHR=basic hourly rate; H&W=health and welfare; IAF=industry advancement fund; LEG=legal fund; L&M=labor/management fund; PEN=pens fund; SAF=safety; SUI=supplemental unemployment insurance; S&L=SUI & LEG combined; TRN=training; THR=total hourly rate; VAC=vacation



Class Code	Classification of Laborers & Mechanics	BHR	H&W	PEN	TRN	Other	Benefits	THR
------------	--	-----	-----	-----	-----	-------	----------	-----

**Culinary Workers**

<b>A0501</b>	Baker/Cook	28.37	8.40	7.56			<b>LEG</b>	44.33
<b>A0503</b>	General Helper	25.05	8.40	7.56			<b>LEG</b>	41.01
	Housekeeper							
	Janitor							
	Kitchen Helper							
<b>A0504</b>	Head Cook	28.97	8.40	7.56			<b>LEG</b>	44.93
<b>A0505</b>	Head Housekeeper	25.45	8.40	7.56			<b>LEG</b>	41.41
	Head Kitchen Help							

**Dredgemen**

\*See per diem note on last page

<b>A0601</b>	Assistant Engineer	40.76	10.35	13.00	1.00		<b>L&amp;M</b>	65.26
	Craneman							
	Electrical Generator Operator (primary pump/power barge/dredge)							
	Engineer							
	Welder							
<b>A0602</b>	Assistant Mate (deckhand)	39.60	10.35	13.00	1.00		<b>L&amp;M</b>	64.10
<b>A0603</b>	Fireman	40.04	10.35	13.00	1.00		<b>L&amp;M</b>	64.54
<b>A0605</b>	Leverman Clamshell	43.29	10.35	13.00	1.00		<b>L&amp;M</b>	67.79
<b>A0606</b>	Leverman Hydraulic	41.53	10.35	13.00	1.00		<b>L&amp;M</b>	66.03
<b>A0607</b>	Mate & Boatman	40.76	10.35	13.00	1.00		<b>L&amp;M</b>	65.26
<b>A0608</b>	Oiler (dredge)	40.04	10.35	13.00	1.00		<b>L&amp;M</b>	64.54

**Electricians**

\*See per diem note on last page

<b>A0701</b>	Inside Cable Splicer	41.27	13.90	13.88	0.95		<b>L&amp;M</b>	<b>LEG</b>	70.35
--------------	----------------------	-------	-------	-------	------	--	----------------	------------	-------

Wage benefits key: BHR=basic hourly rate; H&W=health and welfare; IAF=industry advancement fund; LEG=legal fund; L&M=labor/management fund; PEN=pens fund; SAF=safety; SUI=supplemental unemployment insurance; S&L=SUI & LEG combined; TRN=training; THR=total hourly rate; VAC=vacation

Class Code	Classification of Laborers & Mechanics	BHR	H&W	PEN	TRN	Other	Benefits	THR
------------	--	-----	-----	-----	-----	-------	----------	-----

### Electricians

\*See per diem note on last page

<b>A0702</b>	Inside Journeyman Wireman, including: Technicians (including use of drones in electrical construction)	40.94	13.90	14.12	0.95		<b>L&amp;M</b> 0.20	<b>LEG</b> 0.15	70.26
<b>A0703</b>	Power Cable Splicer	57.79	13.90	18.92	0.95		<b>L&amp;M</b> 0.20	<b>LEG</b> 0.15	91.91
<b>A0704</b>	Tele Com Cable Splicer	50.53	13.90	16.17	0.95		<b>L&amp;M</b> 0.20	<b>LEG</b> 0.15	81.90
<b>A0705</b>	Power Journeyman Lineman, including: Power Equipment Operator Technician (including use of drones in electrical construction)	56.04	13.90	18.87	0.95		<b>L&amp;M</b> 0.20	<b>LEG</b> 0.15	90.11
<b>A0706</b>	Tele Com Journeyman Lineman, including: Technician (including use of drones in telecommunications construction) Tele Com Equipment Operator	48.78	13.90	16.11	0.95		<b>L&amp;M</b> 0.20	<b>LEG</b> 0.15	80.09
<b>A0707</b>	Straight Line Installer - Repairman	48.78	13.90	16.11	0.95		<b>L&amp;M</b> 0.20	<b>LEG</b> 0.15	80.09
<b>A0708</b>	Powderman	54.04	13.90	18.81	0.95		<b>L&amp;M</b> 0.20	<b>LEG</b> 0.15	88.05
<b>A0710</b>	Material Handler	26.57	13.33	4.80	0.15		<b>L&amp;M</b> 0.15	<b>LEG</b> 0.15	45.15
<b>A0712</b>	Tree Trimmer Groundman	28.37	13.90	12.59	0.15		<b>L&amp;M</b> 0.15	<b>LEG</b> 0.15	55.31
<b>A0713</b>	Journeyman Tree Trimmer	37.30	13.90	12.86	0.15		<b>L&amp;M</b> 0.15	<b>LEG</b> 0.15	64.51
<b>A0714</b>	Vegetation Control Sprayer	40.85	13.90	12.97	0.15		<b>L&amp;M</b> 0.15	<b>LEG</b> 0.15	68.17
<b>A0715</b>	Inside Journeyman Communications CO/PBX	39.52	13.90	13.83	0.95		<b>L&amp;M</b> 0.20	<b>LEG</b> 0.15	68.55

### Elevator Workers

\*See per diem note on last page

<b>A0802</b>	Elevator Constructor	41.38	15.73	18.41	0.63		<b>L&amp;M</b> 0.48	<b>VAC</b> 4.59	81.22
<b>A0803</b>	Elevator Constructor Mechanic	59.11	15.73	18.41	0.63		<b>L&amp;M</b> 0.48	<b>VAC</b> 6.56	100.92

Wage benefits key: BHR=basic hourly rate; H&W=health and welfare; IAF=industry advancement fund; LEG=legal fund; L&M=labor/management fund; PEN=pens fund; SAF=safety; SUI=supplemental unemployment insurance; S&L=SUI & LEG combined; TRN=training; THR=total hourly rate; VAC=vacation

Class Code	Classification of Laborers & Mechanics	BHR	H&W	PEN	TRN	Other	Benefits	THR
<b>Heat &amp; Frost Insulators/Asbestos Workers</b>								
*See per diem note on last page								
A0902	Asbestos Abatement-Mechanical Systems	38.68	9.24	11.01	1.20	0.12	SAF	60.25
A0903	Asbestos Abatement/General Demolition All Systems	38.68	9.24	11.01	1.20	0.12	SAF	60.25
A0904	Insulator, Group II	38.68	9.24	11.01	1.20	0.12	SAF	60.25
A0905	Fire Stop	38.68	9.24	11.01	1.20	0.12	SAF	60.25
<b>IronWorkers</b>								
*See per diem note on last page								
A1101	Ironworkers, including:	38.87	9.51	24.28	0.74	0.20	L&M IAF	73.84
	Bender Operators							
	Bridge & Structural							
	Hangar Doors							
	Hollow Metal Doors							
	Industrial Doors							
	Machinery Mover							
	Ornamental							
	Reinforcing							
	Rigger							
	Sheeter							
	Signalman							
	Stage Rigger							
	Toxic Haz-Mat Work							
	Welder							
A1102	Helicopter	39.87	9.51	24.28	0.74	0.20	L&M IAF	74.84
	Helicopter (used for rigging and setting)							
	Tower (energy producing windmill type towers to include nacelle and blades)							
A1103	Fence/Barrier Installer	35.37	9.51	23.93	0.74	0.20	L&M IAF	69.99
A1104	Guard Rail Layout Man	36.11	9.51	23.93	0.74	0.20	L&M IAF	70.73
A1105	Guard Rail Installer	36.37	9.51	23.93	0.74	0.20	L&M IAF	70.99

Wage benefits key: BHR=basic hourly rate; H&W=health and welfare; IAF=industry advancement fund; LEG=legal fund; L&M=labor/management fund; PEN=pens fund; SAF=safety; SUI=supplemental unemployment insurance; S&L=SUI & LEG combined; TRN=training; THR=total hourly rate; VAC=vacation

**Laborers (The Alaska areas north of N63 latitude and east of W138 longitude)**

\*See per diem note on last page

						L&M	LEG	
<b>N1201</b>	Group I, including:	31.71	8.95	17.81	1.30	0.20	0.20	60.17
	Asphalt Worker (shovelman, plant crew)							
	Brush Cutter							
	Camp Maintenance Laborer							
	Carpenter Tender or Helper							
	Choke Setter, Hook Tender, Rigger, Signalman							
	Concrete Labor (curb & gutter, chute handler, curing, grouting, screeding)							
	Crusher Plant Laborer							
	Demolition Laborer							
	Ditch Digger							
	Dumpman							
	Environmental Laborer (hazard/toxic waste, oil spill)							
	Fence Installer							
	Fire Watch Laborer							
	Flagman							
	Form Stripper							
	General Laborer							
	Guardrail Laborer, Bridge Rail Installer							
	Hydro-seeder Nozzleman							
	Laborer, Building							
	Landscaper or Planter							
	Laying of Mortarless Decorative Block (retaining walls, flowered decorative block 4 feet or less - highway or landscape work)							
	Material Handler							
	Pneumatic or Power Tools							
	Portable or Chemical Toilet Serviceman							
	Pump Man or Mixer Man							
	Railroad Track Laborer							
	Sandblast, Pot Tender							
	Saw Tender							
	Slurry Work							
	Steam Cleaner Operator							
	Steam Point or Water Jet Operator							
	Storm Water Pollution Protection Plan Worker (SWPPP Worker - erosion and sediment control Laborer)							
	Tank Cleaning							
	Utiliwalk & Utilidor Laborer							
	Watchman (construction projects)							
	Window Cleaner							

Wage benefits key: BHR=basic hourly rate; H&W=health and welfare; IAF=industry advancement fund; LEG=legal fund; L&M=labor/management fund; PEN=pens fund; SAF=safety; SUI=supplemental unemployment insurance; S&L=SUI & LEG combined; TRN=training; THR=total hourly rate; VAC=vacation

**Laborers (The Alaska areas north of N63 latitude and east of W138 longitude)**

\*See per diem note on last page

						L&M	LEG	
<b>N1202</b>	Group II, including:	32.71	8.95	17.81	1.30	0.20	0.20	61.17
	Burning & Cutting Torch							
	Cement or Lime Dumper or Handler (sack or bulk)							
	Certified Erosion Sediment Control Lead (CESCL Laborer)							
	Choker Splicer							
	Chucktender (wagon, air-track & hydraulic drills)							
	Concrete Laborer (power buggy, concrete saws, pumpcrete nozzleman, vibratorman)							
	Culvert Pipe Laborer							
	Cured Inplace Pipelayer							
	Environmental Laborer (asbestos, marine work)							
	Floor Preparation, Core Drilling							
	Foam Gun or Foam Machine Operator							
	Green Cutter (dam work)							
	Gunite Operator							
	Hod Carrier							
	Jackhammer/Chipping Gun or Pavement Breaker							
	Laser Instrument Operator							
	Laying of Mortarless Decorative Block (retaining walls, flowered decorative block over 4 feet - highway or landscape work)							
	Mason Tender & Mud Mixer (sewer work)							
	Pilot Car							
	Pipelayer Helper							
	Plasterer, Bricklayer & Cement Finisher Tender							
	Powderman Helper							
	Power Saw Operator							
	Railroad Switch Layout Laborer							
	Sandblaster							
	Scaffold Building & Erecting							
	Sewer Caulker							
	Sewer Plant Maintenance Man							
	Thermal Plastic Applicator							
	Timber Faller, Chainsaw Operator, Filer							
	Timberman							

						L&M	LEG	
<b>N1203</b>	Group III, including:	33.61	8.95	17.81	1.30	0.20	0.20	62.07

- Bit Grinder
- Camera/Tool/Video Operator
- Guardrail Machine Operator
- High Rigger & Tree Topper
- High Scaler

Wage benefits key: BHR=basic hourly rate; H&W=health and welfare; IAF=industry advancement fund; LEG=legal fund; L&M=labor/management fund; PEN=pens fund; SAF=safety; SUI=supplemental unemployment insurance; S&L=SUI & LEG combined; TRN=training; THR=total hourly rate; VAC=vacation

**Laborers (The Alaska areas north of N63 latitude and east of W138 longitude)**

\*See per diem note on last page

						L&M	LEG	
<b>N1203</b>	Group III, including:	33.61	8.95	17.81	1.30	0.20	0.20	62.07

- Multiplate
- Plastic Welding
- Slurry Seal Squeegee Man
- Traffic Control Supervisor
- Welding Certified (in connection with laborer's work)

						L&M	LEG	
<b>N1204</b>	Group IIIA	36.89	8.95	17.81	1.30	0.20	0.20	65.35

- Asphalt Raker, Asphalt Belly Dump Lay Down
- Drill Doctor (in the field)
- Driller (including, but not limited to wagon drills, air-track drills, hydraulic drills)
- Pioneer Drilling & Drilling Off Tugger (all type drills)
- Pipelayers
- Powderman (Employee Possessor)
- Storm Water Pollution Protection Plan Specialist (SWPPP Specialist)
- Traffic Control Supervisor, DOT Qualified

						L&M	LEG	
<b>N1205</b>	Group IV	21.28	8.95	17.81	1.30	0.20	0.20	49.74

- Final Building Cleanup
- Permanent Yard Worker

						L&M	LEG	
<b>N1206</b>	Group IIIB	40.68	6.24	17.81	1.30	0.20	0.20	66.43

- Driller (including, but not limited to wagon drills, air-track drills, hydraulic drills)(over 5,000 hours)
- Federal Powderman (Responsible Person in Charge)
- Grade Checking (setting or transferring of grade marks, line and grade, GPS, drones)
- Pioneer Drilling & Drilling Off Tugger (all type drills)(over 5,000 hours)
- Stake Hopper

**Laborers (The area that is south of N63 latitude and west of W138 longitude)**

\*See per diem note on last page

						L&M	LEG	
<b>S1201</b>	Group I, including:	31.71	8.95	17.81	1.30	0.20	0.20	60.17

- Asphalt Worker (shovelman, plant crew)
- Brush Cutter
- Camp Maintenance Laborer
- Carpenter Tender or Helper

Wage benefits key: BHR=basic hourly rate; H&W=health and welfare; IAF=industry advancement fund; LEG=legal fund; L&M=labor/management fund; PEN=pens fund; SAF=safety; SUI=supplemental unemployment insurance; S&L=SUI & LEG combined; TRN=training; THR=total hourly rate; VAC=vacation

**Laborers (The area that is south of N63 latitude and west of W138 longitude)**

\*See per diem note on last page

						<b>L&amp;M</b>	<b>LEG</b>	
<b>S1201</b>	Group I, including:	31.71	8.95	17.81	1.30	0.20	0.20	60.17

- Choke Setter, Hook Tender, Rigger, Signalman
- Concrete Labor (curb & gutter, chute handler, curing, grouting, screeding)
- Crusher Plant Laborer
- Demolition Laborer
- Ditch Digger
- Dumpman
- Environmental Laborer (hazard/toxic waste, oil spill)
- Fence Installer
- Fire Watch Laborer
- Flagman
- Form Stripper
- General Laborer
- Guardrail Laborer, Bridge Rail Installer
- Hydro-seeder Nozzleman
- Laborer, Building
- Landscaper or Planter
- Laying of Mortarless Decorative Block (retaining walls, flowered decorative block 4 feet or less - highway or landscape work)
- Material Handler
- Pneumatic or Power Tools
- Portable or Chemical Toilet Serviceman
- Pump Man or Mixer Man
- Railroad Track Laborer
- Sandblast, Pot Tender
- Saw Tender
- Slurry Work
- Steam Cleaner Operator
- Steam Point or Water Jet Operator
- Storm Water Pollution Protection Plan Worker (SWPPP Worker - erosion and sediment control Laborer)
- Tank Cleaning
- Utiliwalk & Utilidor Laborer
- Watchman (construction projects)
- Window Cleaner

						<b>L&amp;M</b>	<b>LEG</b>	
<b>S1202</b>	Group II, including:	32.71	8.95	17.81	1.30	0.20	0.20	61.17

- Burning & Cutting Torch
- Cement or Lime Dumper or Handler (sack or bulk)
- Certified Erosion Sediment Control Lead (CESCL Laborer)

Wage benefits key: BHR=basic hourly rate; H&W=health and welfare; IAF=industry advancement fund; LEG=legal fund; L&M=labor/management fund; PEN=pens fund; SAF=safety; SUI=supplemental unemployment insurance; S&L=SUI & LEG combined; TRN=training; THR=total hourly rate; VAC=vacation

**Laborers (The area that is south of N63 latitude and west of W138 longitude)**

\*See per diem note on last page

						<b>L&amp;M</b>	<b>LEG</b>	
<b>S1202</b>	Group II, including:	32.71	8.95	17.81	1.30	0.20	0.20	61.17

- Choker Splicer
- Chucktender (wagon, air-track & hydraulic drills)
- Concrete Laborer (power buggy, concrete saws, pumpcrete nozzleman, vibratorman)
- Culvert Pipe Laborer
- Cured Inplace Pipelayer
- Environmental Laborer (asbestos, marine work)
- Floor Preparation, Core Drilling
- Foam Gun or Foam Machine Operator
- Green Cutter (dam work)
- Guniting Operator
- Hod Carrier
- Jackhammer/Chipping Gun or Pavement Breaker
- Laser Instrument Operator
- Laying of Mortarless Decorative Block (retaining walls, flowered decorative block over 4 feet - highway or landscape work)
- Mason Tender & Mud Mixer (sewer work)
- Pilot Car
- Pipelayer Helper
- Plasterer, Bricklayer & Cement Finisher Tender
- Powderman Helper
- Power Saw Operator
- Railroad Switch Layout Laborer
- Sandblaster
- Scaffold Building & Erecting
- Sewer Caulker
- Sewer Plant Maintenance Man
- Thermal Plastic Applicator
- Timber Faller, Chainsaw Operator, Filer
- Timberman

						<b>L&amp;M</b>	<b>LEG</b>	
<b>S1203</b>	Group III, including:	33.61	8.95	17.81	1.30	0.20	0.20	62.07

- Bit Grinder
- Camera/Tool/Video Operator
- Guardrail Machine Operator
- High Rigger & Tree Topper
- High Scaler
- Multiplate
- Plastic Welding
- Slurry Seal Squeegee Man

Wage benefits key: BHR=basic hourly rate; H&W=health and welfare; IAF=industry advancement fund; LEG=legal fund; L&M=labor/management fund; PEN=pens fund; SAF=safety; SUI=supplemental unemployment insurance; S&L=SUI & LEG combined; TRN=training; THR=total hourly rate; VAC=vacation



Class Code	Classification of Laborers & Mechanics	BHR	H&W	PEN	TRN	Other	Benefits	THR
------------	--	-----	-----	-----	-----	-------	----------	-----

**Laborers (The area that is south of N63 latitude and west of W138 longitude)**

\*See per diem note on last page

<b>S1203</b>	Group III, including:	33.61	8.95	17.81	1.30		<b>L&amp;M</b>	<b>LEG</b>	
	Traffic Control Supervisor						0.20	0.20	62.07
	Welding Certified (in connection with laborer's work)								

<b>S1204</b>	Group IIIA	36.89	8.95	17.81	1.30		<b>L&amp;M</b>	<b>LEG</b>	
	Asphalt Raker, Asphalt Belly Dump Lay Down						0.20	0.20	65.35
	Drill Doctor (in the field)								
	Driller (including, but not limited to wagon drills, air-track drills, hydraulic drills)								
	Pioneer Drilling & Drilling Off Tugger (all type drills)								
	Pipelayers								
	Powderman (Employee Possessor)								
	Storm Water Pollution Protection Plan Specialist (SWPPP Specialist)								
	Traffic Control Supervisor, DOT Qualified								

<b>S1205</b>	Group IV	21.28	8.95	17.81	1.30		<b>L&amp;M</b>	<b>LEG</b>	
	Final Building Cleanup						0.20	0.20	49.74
	Permanent Yard Worker								

<b>S1206</b>	Group IIIB	40.68	6.24	17.81	1.30		<b>L&amp;M</b>	<b>LEG</b>	
	Driller (including, but not limited to wagon drills, air-track drills, hydraulic drills)(over 5,000 hours)						0.20	0.20	66.43
	Federal Powderman (Responsible Person in Charge)								
	Grade Checking (setting or transferring of grade marks, line and grade, GPS, drones)								
	Pioneer Drilling & Drilling Off Tugger (all type drills)(over 5,000 hours)								
	Stake Hopper								

**Millwrights**

\*See per diem note on last page

<b>A1251</b>	Millwright (journeyman)	40.77	10.08	12.28	1.10		<b>L&amp;M</b>		
							0.40	0.05	64.68

<b>A1252</b>	Millwright Welder	41.77	10.08	12.28	1.10		<b>L&amp;M</b>		
							0.40	0.05	65.68

**Painters, Region I (North of N63 latitude)**

\*See per diem note on last page

<b>N1301</b>	Group I, including:	32.99	8.71	13.50	1.08		<b>L&amp;M</b>		
							0.07		56.35

Wage benefits key: BHR=basic hourly rate; H&W=health and welfare; IAF=industry advancement fund; LEG=legal fund; L&M=labor/management fund; PEN=pens fund; SAF=safety; SUI=supplemental unemployment insurance; S&L=SUI & LEG combined; TRN=training; THR=total hourly rate; VAC=vacation

**Painters, Region I (North of N63 latitude)**

\*See per diem note on last page

<b>N1301</b>	Group I, including:	32.99	8.71	13.50	1.08		<b>L&amp;M</b> 0.07	56.35
--------------	---------------------	-------	------	-------	------	--	------------------------	-------

- Brush
- General Painter
- Hand Taping
- Hazardous Material Handler
- Lead-Based Paint Abatement
- Roll

<b>N1302</b>	Group II, including:	33.51	8.71	13.50	1.08		<b>L&amp;M</b> 0.07	56.87
--------------	----------------------	-------	------	-------	------	--	------------------------	-------

- Bridge Painter
- Epoxy Applicator
- General Drywall Finisher
- Hand/Spray Texturing
- Industrial Coatings Specialist
- Machine/Automatic Taping
- Pot Tender
- Sandblasting
- Specialty Painter
- Spray
- Structural Steel Painter
- Wallpaper/Vinyl Hanger

<b>N1304</b>	Group IV, including:	39.64	8.71	16.37	1.05		0.05	65.82
--------------	----------------------	-------	------	-------	------	--	------	-------

- Glazier
- Storefront/Automatic Door Mechanic

<b>N1305</b>	Group V, including:	28.63	8.71	5.02	0.83		0.07	43.26
--------------	---------------------	-------	------	------	------	--	------	-------

- Carpet Installer
- Floor Coverer
- Heat Weld/Cove Base
- Linoleum/Soft Tile Installer

**Painters, Region II (South of N63 latitude)**

\*See per diem note on last page

<b>S1301</b>	Group I, including :	30.33	8.71	14.15	1.08		<b>L&amp;M</b> 0.07	54.34
--------------	----------------------	-------	------	-------	------	--	------------------------	-------

- Brush
- General Painter
- Hand Taping
- Hazardous Material Handler

Wage benefits key: BHR=basic hourly rate; H&W=health and welfare; IAF=industry advancement fund; LEG=legal fund; L&M=labor/management fund; PEN=pens fund; SAF=safety; SUI=supplemental unemployment insurance; S&L=SUI & LEG combined; TRN=training; THR=total hourly rate; VAC=vacation

**Painters, Region II (South of N63 latitude)**

\*See per diem note on last page

<b>S1301</b>	Group I, including :	30.33	8.71	14.15	1.08		<b>L&amp;M</b> 0.07	54.34
--------------	----------------------	-------	------	-------	------	--	------------------------	-------

Lead-Based Paint Abatement  
Roll  
Spray

<b>S1302</b>	Group II, including :	31.58	8.71	14.15	1.08		<b>L&amp;M</b> 0.07	55.59
--------------	-----------------------	-------	------	-------	------	--	------------------------	-------

General Drywall Finisher  
Hand/Spray Texturing  
Machine/Automatic Taping  
Wallpaper/Vinyl Hanger

<b>S1303</b>	Group III, including :	31.68	8.71	14.15	1.08		<b>L&amp;M</b> 0.07	55.69
--------------	------------------------	-------	------	-------	------	--	------------------------	-------

Bridge Painter  
Epoxy Applicator  
Industrial Coatings Specialist  
Pot Tender  
Sandblasting  
Specialty Painter  
Structural Steel Painter

<b>S1304</b>	Group IV, including:	39.85	8.71	15.41	1.08		<b>L&amp;M</b> 0.07	65.12
--------------	----------------------	-------	------	-------	------	--	------------------------	-------

Glazier  
Storefront/Automatic Door Mechanic

<b>S1305</b>	Group V, including:	28.63	8.71	5.02	0.83		<b>L&amp;M</b> 0.07	43.26
--------------	---------------------	-------	------	------	------	--	------------------------	-------

Carpet Installer  
Floor Coverer  
Heat Weld/Cove Base  
Linoleum/Soft Tile Installer

**Piledrivers**

\*See per diem note on last page

<b>A1401</b>	Piledriver	38.34	10.08	15.23	1.10		<b>L&amp;M</b> 0.10	<b>IAF</b> 0.10	64.95
--------------	------------	-------	-------	-------	------	--	------------------------	--------------------	-------

Assistant Dive Tender  
Carpenter/Piledriver  
Rigger  
Sheet Stabber  
Skiff Operator

Wage benefits key: BHR=basic hourly rate; H&W=health and welfare; IAF=industry advancement fund; LEG=legal fund; L&M=labor/management fund; PEN=pens fund; SAF=safety; SUI=supplemental unemployment insurance; S&L=SUI & LEG combined; TRN=training; THR=total hourly rate; VAC=vacation

Class Code	Classification of Laborers & Mechanics	BHR	H&W	PEN	TRN	Other	Benefits	THR
------------	--	-----	-----	-----	-----	-------	----------	-----

**Piledrivers**  
\*See per diem note on last page

<b>A1402</b>	Piledriver-Welder/Toxic Worker	39.34	10.08	15.23	1.10	L&M	IAF	65.95
<b>A1403</b>	Remotely Operated Vehicle Pilot/Technician Single Atmosphere Suit, Bell or Submersible Pilot	42.65	10.08	15.23	1.10	L&M	IAF	69.26
<b>A1404</b>	Diver (working) **See note on last page	82.45	10.08	15.23	1.10	L&M	IAF	109.06
<b>A1405</b>	Diver (standby) **See note on last page	42.65	10.08	15.23	1.10	L&M	IAF	69.26
<b>A1406</b>	Dive Tender **See note on last page	41.65	10.08	15.23	1.10	L&M	IAF	68.26
<b>A1407</b>	Welder (American Welding Society, Certified Welding Inspector)	43.90	10.08	15.23	1.10	L&M	IAF	70.51

**Plumbers, Region I (North of N63 latitude)**  
\*See per diem note on last page

<b>N1501</b>	Journeyman Pipefitter Plumber Welder	41.91	11.25	17.20	1.50	L&M	S&L	72.51
--------------	--	-------	-------	-------	------	-----	-----	-------

**Plumbers, Region II (South of N63 latitude)**  
\*See per diem note on last page

<b>S1501</b>	Journeyman Pipefitter Plumber Welder	41.00	11.13	15.02	1.55	L&M		68.90
--------------	--	-------	-------	-------	------	-----	--	-------

**Plumbers, Region IIA (1st Judicial District)**  
\*See per diem note on last page

<b>X1501</b>	Journeyman Pipefitter Plumber Welder	38.82	13.37	11.75	2.50	L&M		66.68
--------------	--	-------	-------	-------	------	-----	--	-------

**Power Equipment Operators**  
\*See per diem note on last page

<b>A1601</b>	Group I, including:	41.53	10.35	13.00	1.00	L&M		66.03
--------------	---------------------	-------	-------	-------	------	-----	--	-------

Wage benefits key: BHR=basic hourly rate; H&W=health and welfare; IAF=industry advancement fund; LEG=legal fund; L&M=labor/management fund; PEN=pens fund; SAF=safety; SUI=supplemental unemployment insurance; S&L=SUI & LEG combined; TRN=training; THR=total hourly rate; VAC=vacation

**Power Equipment Operators**

\*See per diem note on last page

	<b>L&amp;M</b>						
<b>A1601</b> Group I, including:	41.53	10.35	13.00	1.00	0.10	0.05	66.03
Asphalt Roller: Breakdown, Intermediate, and Finish							
Back Filler							
Barrier Machine (Zipper)							
Beltcrete with Power Pack & similar conveyors							
Bending Machine							
Boat Coxswain							
Bulldozer							
Cableways, Highlines & Cablecars							
Cleaning Machine							
Coating Machine							
Concrete Hydro Blaster							
Cranes (45 tons & under or 150 feet of boom & under (including jib & attachments))							
(a) Hydralifts or Transporters, (all track or truck type)							
(b) Derricks							
(c) Overhead							
Crushers							
Deck Winches, Double Drum							
Ditching or Trenching Machine (16 inch or over)							
Drag Scraper, Yarder, and similar types							
Drilling Machines, Core, Cable, Rotary and Exploration							
Finishing Machine Operator, Concrete Paving, Laser Screed, Sidewalk, Curb & Gutter Machine							
Grade Checker and/or Line and Grade including Drone							
Helicopters							
Hover Craft, Flex Craft, Loadmaster, Air Cushion, All-Terrain Vehicle, Rollagon, Bargecable, Nodwell, & Snow Cat							
Hydro Ax, Feller Buncher & similar							
Hydro Excavation (Vac-Truck and Similar)							
Loaders (2 1/2 yards through 5 yards, including all attachments):							
(a) Forklifts (with telescopic boom & swing attachment)							
(b) Front End & Overhead, (2-1/2 yards through 5 yards)							
(c) Loaders, (with forks or pipe clamp)							
(d) Loaders, (elevating belt type, Euclid & similar types)							
Material Transfer Vehicle (Elevating Grader, Pickup Machine, and similar types)							
Mechanic, Welder, Bodyman, Electrical, Camp & Maintenance Engineer							
Micro Tunneling Machine							
Mixers: Mobile type with hoist combination							
Motor Patrol Grader							

Wage benefits key: BHR=basic hourly rate; H&W=health and welfare; IAF=industry advancement fund; LEG=legal fund; L&M=labor/management fund; PEN=pens fund; SAF=safety; SUI=supplemental unemployment insurance; S&L=SUI & LEG combined; TRN=training; THR=total hourly rate; VAC=vacation

**Power Equipment Operators**

\*See per diem note on last page

							<b>L&amp;M</b>						
<b>A1601</b>	Group I, including:						41.53	10.35	13.00	1.00	0.10	0.05	66.03
Mucking Machine: Mole, Tunnel Drill, Horizontal/Directional Drill Operator and/or Shield Off-Road Hauler (including Articulating and Haul Trucks) Operator on Dredges Piledriver Engineer, L.B. Foster, Puller or similar paving breaker Plant Operator (Asphalt & Concrete) Power Plant, Turbine Operator 200 k.w & over (power plants or combination of power units over 300 k.w.) Remote Controlled Equipment Scraper (through 40 yards) Service Oiler/Service Engineer Shot Blast Machine Shovels, Backhoes, Excavators with all attachments, and Gradealls (3 yards & under) Sideboom (under 45 tons) Sub Grader (Gurries & similar types) Tack Tractor Truck Mounted Concrete Pump, Conveyor/Tele-belt, & Creter Wate Kote Machine													

							<b>L&amp;M</b>						
<b>A1602</b>	Group IA, including:						43.29	10.35	13.00	1.00	0.10	0.05	67.79
Camera/Tool/Video Operator (Slipline) Certified Welder, Electrical Mechanic, Camp Maintenance Engineer, Mechanic (over 10,000 hours) Cranes (over 45 tons or 150 feet including jib & attachments) (a) Clamshells & Draglines (over 3 yards) (b) Tower Cranes Licensed Water/Waste Water Treatment Operator Loaders (over 5 yards) Motor Patrol Grader, Dozer, Grade Tractor (finish: when finishing to final grade and/or to hubs, or for asphalt) Power Plants (1000 k.w. & over) Profiler, Reclaimer, and Roto-Mill Quad Scrapers (over 40 yards) Screed Shovels, Backhoes, Excavators with all attachments (over 3 yards) Sidebooms (over 45 tons) Slip Form Paver, C.M.I. & similar types Topside (Asphalt Paver, Slurry machine, Spreaders, and similar types)													

Wage benefits key: BHR=basic hourly rate; H&W=health and welfare; IAF=industry advancement fund; LEG=legal fund; L&M=labor/management fund; PEN=pens fund; SAF=safety; SUI=supplemental unemployment insurance; S&L=SUI & LEG combined; TRN=training; THR=total hourly rate; VAC=vacation

**Power Equipment Operators**

\*See per diem note on last page

	<b>L&amp;M</b>						
<b>A1603</b> Group II, including:	40.76	10.35	13.00	1.00	0.10	0.05	65.26
Boiler - Fireman							
Cement Hogs & Concrete Pump Operator							
Conveyors (except those listed in Group I)							
Hoists on Steel Erection, Towermobiles & Air Tuggers							
Horizontal/Directional Drill Locator							
Locomotives, Rod & Geared Engines							
Mixers							
Screening, Washing Plant							
Sideboom (cradling rock drill, regardless of size)							
Skidder							
Trenching Machines (under 16 inches)							
Water/Waste Water Treatment Operator							

	<b>L&amp;M</b>						
<b>A1604</b> Group III, including:	40.04	10.35	13.00	1.00	0.10	0.05	64.54
"A" Frame Trucks, Deck Winches							
Bombardier (tack or tow rig)							
Boring Machine							
Brooms, Power (sweeper, elevator, vacuum, or similar)							
Bump Cutter							
Compressor							
Farm Tractor							
Forklift, Industrial Type							
Gin Truck or Winch Truck (with poles when used for hoisting)							
Hoists, Air Tuggers, Elevators							
Loaders:							
(a) Elevating-Athey, Barber Greene & similar types							
(b) Forklifts or Lumber Carrier (on construction job sites)							
(c) Forklifts, (with tower)							
(d) Overhead & Front End, (under 2-1/2 yards)							
Locomotives: Dinkey (air, steam, gas & electric) Speeders							
Mechanics, Light Duty							
Oil, Blower Distribution							
Posthole Digger, Mechanical							
Pot Fireman (power agitated)							
Power Plant, Turbine Operator, (under 200 k.w.)							
Pumps, Water							
Roller (other than Asphalt)							
Saws, Concrete							
Skid Hustler							
Skid Steer (with all attachments)							

Wage benefits key: BHR=basic hourly rate; H&W=health and welfare; IAF=industry advancement fund; LEG=legal fund; L&M=labor/management fund; PEN=pens fund; SAF=safety; SUI=supplemental unemployment insurance; S&L=SUI & LEG combined; TRN=training; THR=total hourly rate; VAC=vacation

Class Code	Classification of Laborers & Mechanics	BHR	H&W	PEN	TRN	Other	Benefits	THR
------------	--	-----	-----	-----	-----	-------	----------	-----

**Power Equipment Operators**

\*See per diem note on last page

<b>A1604</b>	Group III, including:	40.04	10.35	13.00	1.00		<b>L&amp;M</b>	
	Stake Hopper					0.10	0.05	64.54
	Straightening Machine							
	Tow Tractor							

<b>A1605</b>	Group IV, including:	33.83	10.35	13.00	1.00		<b>L&amp;M</b>	
	Crane Assistant Engineer/Rig Oiler					0.10	0.05	58.33
	Drill Helper							
	Parts & Equipment Coordinator							
	Spotter							
	Steam Cleaner							
	Swamper (on trenching machines or shovel type equipment)							

**Roofers**

\*See per diem note on last page

<b>A1701</b>	Roofer & Waterproofer	44.62	11.75	3.91	0.81		<b>L&amp;M</b>	
						0.10	0.06	61.25
<b>A1702</b>	Roofer Material Handler	31.23	11.75	3.91	0.81		<b>L&amp;M</b>	
						0.10	0.06	47.86

**Sheet Metal Workers, Region I (North of N63 latitude)**

\*See per diem note on last page

<b>N1801</b>	Sheet Metal Journeyman	48.64	11.50	14.11	1.65		<b>L&amp;M</b>	
	Air Balancing and duct cleaning of HVAC systems					0.12		76.02
	Brazing, soldering or welding of metals							
	Demolition of sheet metal HVAC systems							
	Fabrication and installation of exterior wall sheathing, siding, metal roofing, flashing, decking and architectural sheet metal work							
	Fabrication and installation of heating, ventilation and air conditioning ducts and equipment							
	Fabrication and installation of louvers and hoods							
	Fabrication and installation of sheet metal lagging							
	Fabrication and installation of stainless steel commercial or industrial food service equipment							
	Manufacture, fabrication assembly, installation and alteration of all ferrous and nonferrous metal work							
	Metal lavatory partitions							
	Preparation of drawings taken from architectural and engineering plans required for fabrication and erection of sheet metal work							

Wage benefits key: BHR=basic hourly rate; H&W=health and welfare; IAF=industry advancement fund; LEG=legal fund; L&M=labor/management fund; PEN=pens fund; SAF=safety; SUI=supplemental unemployment insurance; S&L=SUI & LEG combined; TRN=training; THR=total hourly rate; VAC=vacation



Class Code	Classification of Laborers & Mechanics	BHR	H&W	PEN	TRN	Other	Benefits	THR
------------	--	-----	-----	-----	-----	-------	----------	-----

**Sheet Metal Workers, Region I (North of N63 latitude)**

\*See per diem note on last page

<b>N1801</b>	Sheet Metal Journeyman	48.64	11.50	14.11	1.65	0.12	<b>L&amp;M</b>	76.02
--------------	------------------------	-------	-------	-------	------	------	----------------	-------

- Sheet Metal shelving
- Sheet Metal venting, chimneys and breaching
- Skylight installation

**Sheet Metal Workers, Region II (South of N63 latitude)**

\*See per diem note on last page

<b>S1801</b>	Sheet Metal Journeyman	43.20	11.50	14.09	1.68	0.43	<b>L&amp;M</b>	70.90
--------------	------------------------	-------	-------	-------	------	------	----------------	-------

- Air Balancing and duct cleaning of HVAC systems
- Brazing, soldering or welding of metals
- Demolition of sheet metal HVAC systems
- Fabrication and installation of exterior wall sheathing, siding, metal roofing, flashing, decking and architectural sheet metal work
- Fabrication and installation of heating, ventilation and air conditioning ducts and equipment
- Fabrication and installation of louvers and hoods
- Fabrication and installation of sheet metal lagging
- Fabrication and installation of stainless steel commercial or industrial food service equipment
- Manufacture, fabrication assembly, installation and alteration of all ferrous and nonferrous metal work
- Metal lavatory partitions
- Preparation of drawings taken from architectural and engineering plans required for fabrication and erection of sheet metal work
- Sheet Metal shelving
- Sheet Metal venting, chimneys and breaching
- Skylight installation

**Sprinkler Fitters**

\*See per diem note on last page

<b>A1901</b>	Sprinkler Fitter	47.25	10.23	17.85	0.52	0.25	<b>L&amp;M</b>	76.10
--------------	------------------	-------	-------	-------	------	------	----------------	-------

**Surveyors**

\*See per diem note on last page

<b>A2001</b>	Chief of Parties	44.16	11.43	12.64	1.15	0.10	<b>L&amp;M</b>	69.48
--------------	------------------	-------	-------	-------	------	------	----------------	-------

<b>A2002</b>	Party Chief	42.57	11.43	12.64	1.15	0.10	<b>L&amp;M</b>	67.89
--------------	-------------	-------	-------	-------	------	------	----------------	-------

Wage benefits key: BHR=basic hourly rate; H&W=health and welfare; IAF=industry advancement fund; LEG=legal fund; L&M=labor/management fund; PEN=pens fund; SAF=safety; SUI=supplemental unemployment insurance; S&L=SUI & LEG combined; TRN=training; THR=total hourly rate; VAC=vacation

Class Code	Classification of Laborers & Mechanics	BHR	H&W	PEN	TRN	Other Benefits	THR
------------	--	-----	-----	-----	-----	----------------	-----

**Surveyors**

\*See per diem note on last page

<b>A2003</b>	Line & Grade Technician/Office Technician/GPS, Drones	41.97	11.43	12.64	1.15	<b>L&amp;M</b> 0.10	67.29
--------------	---	-------	-------	-------	------	------------------------	-------

<b>A2004</b>	Associate Party Chief (including Instrument Person & Head Chain Person)/Stake Hop/Grademan	39.85	11.43	12.64	1.15	<b>L&amp;M</b> 0.10	65.17
--------------	--	-------	-------	-------	------	------------------------	-------

<b>A2006</b>	Chain Person (for crews with more than 2 people)	35.51	11.43	12.64	1.15	<b>L&amp;M</b> 0.10	60.83
--------------	--	-------	-------	-------	------	------------------------	-------

**Truck Drivers**

\*See per diem note on last page

<b>A2101</b>	Group I, including:	40.94	11.43	12.64	1.15	<b>L&amp;M</b> 0.10	66.26
--------------	---------------------	-------	-------	-------	------	------------------------	-------

- Air/Sea Traffic Controllers
- Ambulance/Fire Truck Driver (EMT certified)
- Boat Coxswain
- Captains & Pilots (air & water)
- Deltas, Commanders, Rollagons, & similar equipment (when pulling sleds, trailers or similar equipment)
- Dump Trucks (including rockbuggy, side dump, belly dump, & trucks with pups) over 40 yards up to & including 60 yards
- Helicopter Transporter
- Liquid Vac Truck/Super Vac Truck
- Material Coordinator or Purchasing Agent
- Ready-mix (over 12 yards up to & including 15 yards) (over 15 yards to be negotiated)
- Semi with Double Box Mixer
- Tireman, Heavy Duty/Fueler
- Water Wagon (250 Bbls and above)

<b>A2102</b>	Group 1A including:	42.21	11.43	12.64	1.15	<b>L&amp;M</b> 0.10	67.53
--------------	---------------------	-------	-------	-------	------	------------------------	-------

- Dump Trucks (including rockbuggy, side dump, belly dump & trucks with pups) over 60 yards up to & including 100 yards (over 100 yards to be negotiated)
- Jeeps (driver under load)
- Lowboys, including tractor attached trailers & jeeps, up to & including 12 axles (over 12 axles or 150 tons to be negotiated)

<b>A2103</b>	Group II, including:	39.68	11.43	12.64	1.15	<b>L&amp;M</b> 0.10	65.00
--------------	----------------------	-------	-------	-------	------	------------------------	-------

- All Deltas, Commanders, Rollagons, & similar equipment
- Batch Trucks (8 yards & up)
- Batch Trucks (up to & including 7 yards)

Wage benefits key: BHR=basic hourly rate; H&W=health and welfare; IAF=industry advancement fund; LEG=legal fund; L&M=labor/management fund; PEN=pens fund; SAF=safety; SUI=supplemental unemployment insurance; S&L=SUI & LEG combined; TRN=training; THR=total hourly rate; VAC=vacation

**Truck Drivers**  
 \*See per diem note on last page

						L&M	
<b>A2103</b>	Group II, including:	39.68	11.43	12.64	1.15	0.10	65.00
	Boom Truck/Knuckle Truck (over 5 tons)						
	Cacasco Truck/Heat Stress Truck						
	Construction and Material Safety Technician						
	Dump Trucks (including rockbuggy, side dump, belly dump, & trucks with pups) over 20 yards up to & including 40 yards						
	Gin Pole Truck, Winch Truck, Wrecker (truck mounted "A" frame manufactured rating over 5 tons)						
	Mechanics						
	Oil Distributor Driver						
	Partsman						
	Ready-mix (up to & including 12 yards)						
	Stringing Truck						
	Turn-O-Wagon or DW-10 (not self loading)						

						L&M	
<b>A2104</b>	Group III, including:	38.86	11.43	12.64	1.15	0.10	64.18
	Boom Truck/Knuckle Truck (up to & including 5 tons)						
	Dump Trucks (including rockbuggy, side dump, belly dump, & trucks with pups) over 10 yards up to & including 20 yards						
	Expeditor (electrical & pipefitting materials)						
	Gin Pole Truck, Winch Truck, Wrecker (truck mounted "A" frame manufactured rating 5 tons & under)						
	Greaser - Shop						
	Semi or Truck & Trailer						
	Thermal Plastic Layout Technician						
	Traffic Control Technician						
	Trucks/Jeeps (push or pull)						

						L&M	
<b>A2105</b>	Group IV, including:	38.28	11.43	12.64	1.15	0.10	63.60
	Air Cushion or similar type vehicle						
	All Terrain Vehicle						
	Buggymobile						
	Bull Lift & Fork Lift, Fork Lift with Power Boom & Swing Attachment (over 5 tons)						
	Bus Operator (over 30 passengers)						
	Cement Spreader, Dry						
	Combination Truck-Fuel & Grease						
	Compactor (when pulled by rubber tired equipment)						
	Dump Trucks (including rockbuggy, side dump, belly dump, & trucks with pups) up to & including 10 yards						
	Dumpster						

Wage benefits key: BHR=basic hourly rate; H&W=health and welfare; IAF=industry advancement fund; LEG=legal fund; L&M=labor/management fund; PEN=pens fund; SAF=safety; SUI=supplemental unemployment insurance; S&L=SUI & LEG combined; TRN=training; THR=total hourly rate; VAC=vacation

**Truck Drivers**

\*See per diem note on last page

						<b>L&amp;M</b>	
<b>A2105</b>	Group IV, including:	38.28	11.43	12.64	1.15	0.10	63.60
	Expeditor (general)						
	Fire Truck/Ambulance Driver						
	Flat Beds, Dual Rear Axle						
	Foam Distributor Truck Dual Axle						
	Front End Loader with Fork						
	Grease Truck						
	Hydro Seeder, Dual Axle						
	Hyster Operators (handling bulk aggregate)						
	Loadmaster (air & water operations)						
	Lumber Carrier						
	Ready-mix, (up to & including 7 yards)						
	Rigger (air/water/oilfield)						
	Tireman, Light Duty						
	Track Truck Equipment						
	Truck Vacuum Sweeper						
	Warehouseperson						
	Water Truck (Below 250 Bbls)						
	Water Truck (straight)						
	Water Wagon, Semi						

						<b>L&amp;M</b>	
<b>A2106</b>	Group V, including:	37.52	11.43	12.64	1.15	0.10	62.84
	Buffer Truck						
	Bull Lifts & Fork Lifts, Fork Lifts with Power Boom & Swing Attachments (up to & including 5 tons)						
	Bus Operator (up to 30 passengers)						
	Farm Type Rubber Tired Tractor (when material handling or pulling wagons on a construction project)						
	Flat Beds, Single Rear Axle						
	Foam Distributor Truck Single Axle						
	Fuel Handler (station/bulk attendant)						
	Gear/Supply Truck						
	Gravel Spreader Box Operator on Truck						
	Hydro Seeders, Single axle						
	Pickups (pilot cars & all light-duty vehicles)						
	Rigger/Swamper						
	Tack Truck						
	Team Drivers (horses, mules, & similar equipment)						

**Tunnel Workers, Laborers (The Alaska areas north of N63 latitude and east of W138 longitude)**

\*See per diem note on last page

Wage benefits key: BHR=basic hourly rate; H&W=health and welfare; IAF=industry advancement fund; LEG=legal fund; L&M=labor/management fund; PEN=pens fund; SAF=safety; SUI=supplemental unemployment insurance; S&L=SUI & LEG combined; TRN=training; THR=total hourly rate; VAC=vacation

**Tunnel Workers, Laborers (The Alaska areas north of N63 latitude and east of W138 longitude)**  
 \*See per diem note on last page

						L&M	LEG	
<b>N2201</b>	Group I, including:	34.88	8.95	17.81	1.30	0.20	0.20	63.34
	Brakeman							
	Mucker							
	Nipper							
	Storm Water Pollution Protection Plan Worker (SWPPP Worker - erosion and sediment control Laborer)							
	Topman & Bull Gang							
	Tunnel Track Laborer							

						L&M	LEG	
<b>N2202</b>	Group II, including:	35.98	8.95	17.81	1.30	0.20	0.20	64.44
	Burning & Cutting Torch							
	Certified Erosion Sediment Control Lead (CESCL Laborer)							
	Concrete Laborer							
	Floor Preparation, Core Drilling							
	Jackhammer/Chipping Gun or Pavement Breaker							
	Laser Instrument Operator							
	Nozzlemen, Pumcrete or Shotcrete							
	Pipelayer Helper							

						L&M	LEG	
<b>N2203</b>	Group III, including:	36.97	8.95	17.81	1.30	0.20	0.20	65.43
	Miner							
	Retimberman							

						L&M	LEG	
<b>N2204</b>	Group IIIA, including:	40.58	8.95	17.81	1.30	0.20	0.20	69.04
	Asphalt Raker, Asphalt Belly Dump Lay Down							
	Drill Doctor (in the field)							
	Driller (including, but not limited to wagon drills, air-track drills, hydraulic drills)							
	Pioneer Drilling & Drilling Off Tugger (all type drills)							
	Pipelayer							
	Powderman (Employee Possessor)							
	Storm Water Pollution Protection Plan Specialist (SWPPP Specialist)							
	Traffic Control Supervisor, DOT Qualified							

						L&M	LEG	
<b>N2206</b>	Group IIIB, including:	44.75	6.24	17.81	1.30	0.20	0.20	70.50
	Driller (including, but not limited to wagon drills, air-track drills, hydraulic drills)(over 5,000 hours)							
	Federal Powderman (Responsible Person in Charge)							
	Grade Checking (setting or transferring of grade marks, line and grade, GPS, drones)							

Wage benefits key: BHR=basic hourly rate; H&W=health and welfare; IAF=industry advancement fund; LEG=legal fund; L&M=labor/management fund; PEN=pens fund; SAF=safety; SUI=supplemental unemployment insurance; S&L=SUI & LEG combined; TRN=training; THR=total hourly rate; VAC=vacation

**Tunnel Workers, Laborers (The Alaska areas north of N63 latitude and east of W138 longitude)**  
 \*See per diem note on last page

						L&M	LEG	
<b>N2206</b>	Group IIIB, including:	44.75	6.24	17.81	1.30	0.20	0.20	70.50
	Pioneer Drilling & Drilling Off Tugger (all type drills)(over 5,000 hours)							
	Stake Hopper							

**Tunnel Workers, Laborers (The area that is south of N63 latitude and west of W138 longitude)**  
 \*See per diem note on last page

						L&M	LEG	
<b>S2201</b>	Group I, including:	34.88	8.95	17.81	1.30	0.20	0.20	63.34
	Brakeman							
	Mucker							
	Nipper							
	Storm Water Pollution Protection Plan Worker (SWPPP Worker - erosion and sediment control Laborer)							
	Topman & Bull Gang							
	Tunnel Track Laborer							

						L&M	LEG	
<b>S2202</b>	Group II, including:	35.98	8.95	17.81	1.30	0.20	0.20	64.44
	Burning & Cutting Torch							
	Certified Erosion Sediment Control Lead (CESCL Laborer)							
	Concrete Laborer							
	Floor Preparation, Core Drilling							
	Jackhammer/Chipping Gun or Pavement Breaker							
	Laser Instrument Operator							
	Nozzlemen, Pumcrete or Shotcrete							
	Pipelayer Helper							

						L&M	LEG	
<b>S2203</b>	Group III, including:	36.97	8.95	17.81	1.30	0.20	0.20	65.43
	Miner							
	Retimberman							

						L&M	LEG	
<b>S2204</b>	Group IIIA, including:	40.58	8.95	17.81	1.30	0.20	0.20	69.04
	Asphalt Raker, Asphalt Belly Dump Lay Down							
	Drill Doctor (in the field)							
	Driller (including, but not limited to wagon drills, air-track drills, hydraulic drills)							
	Pioneer Drilling & Drilling Off Tugger (all type drills)							
	Pipelayer							
	Powderman (Employee Possessor)							
	Storm Water Pollution Protection Plan Specialist (SWPPP Specialist)							

Wage benefits key: BHR=basic hourly rate; H&W=health and welfare; IAF=industry advancement fund; LEG=legal fund; L&M=labor/management fund; PEN=pens fund; SAF=safety; SUI=supplemental unemployment insurance; S&L=SUI & LEG combined; TRN=training; THR=total hourly rate; VAC=vacation

**Tunnel Workers, Laborers (The area that is south of N63 latitude and west of W138 longitude)**  
 \*See per diem note on last page

<b>S2204</b>	Group IIIA, including:	40.58	8.95	17.81	1.30		<b>L&amp;M</b>	<b>LEG</b>	
							0.20	0.20	69.04

Traffic Control Supervisor, DOT Qualified

<b>S2206</b>	Group IIIB, including:	44.75	6.24	17.81	1.30		<b>L&amp;M</b>	<b>LEG</b>	
							0.20	0.20	70.50

Driller (including, but not limited to wagon drills, air-track drills, hydraulic drills)(over 5,000 hours)  
 Federal Powderman (Responsible Person in Charge)  
 Grade Checking (setting or transferring of grade marks, line and grade, GPS, drones)  
 Pioneer Drilling & Drilling Off Tugger (all type drills)(over 5,000 hours)  
 Stake Hopper

**Tunnel Workers, Power Equipment Operators**  
 \*See per diem note on last page

<b>A2207</b>	Group I	45.68	10.35	13.00	1.00		<b>L&amp;M</b>		
							0.10	0.05	70.18

<b>A2208</b>	Group IA	47.62	10.35	13.00	1.00		<b>L&amp;M</b>		
							0.10	0.05	72.12

<b>A2209</b>	Group II	44.84	10.35	13.00	1.00		<b>L&amp;M</b>		
							0.10	0.05	69.34

<b>A2210</b>	Group III	44.04	10.35	13.00	1.00		<b>L&amp;M</b>		
							0.10	0.05	68.54

<b>A2211</b>	Group IV	37.21	10.35	13.00	1.00		<b>L&amp;M</b>		
							0.10	0.05	61.71

\* Per diem is an established practice for this classification. This means that per diem is an allowable alternative to board and lodging if all criteria are met. See 8 AAC 30.051-08 AAC 30.056, and the per diem information on page vii of this Pamphlet.

\*\* Work in combination of classifications: Employees working in any combination of classifications within the diving crew (working diver, standby diver, and tender) in a shift are paid in the classification with the highest rate for a minimum of 8 hours per shift.

Wage benefits key: BHR=basic hourly rate; H&W=health and welfare; IAF=industry advancement fund; LEG=legal fund; L&M=labor/management fund; PEN=pens fund; SAF=safety; SUI=supplemental unemployment insurance; S&L=SUI & LEG combined; TRN=training; THR=total hourly rate; VAC=vacation

## SECTION 00853 – STANDARD DETAILS

### PART 1 – GENERAL

#### 1.1 STANDARD DETAILS

- A. Whenever references are made to the Standard Drawings or Standard Details in these plans of Specifications the intent is to refer to the current City and Borough of Juneau Standard Details (currently the 4<sup>th</sup> Edition dated August 2011), copies of which may be purchased from the CBJ Engineering Department.
- B. City and Borough of Juneau Standard Details which specifically apply to the Project include but are not limited to the following:

#### LIST OF DETAILS

<u>STANDARD DETAIL NO.</u>	<u>NAME OF DETAIL</u>
104B	CULVERT HEADWALL WITHOUT HINGED TRASH RACK
107	LOCAL ACCESS STREET CUL-DE-SAC
111A	CONCRETE SIDEWALK, TYPE I CURB & GUTTER
111B	CURB & GUTTER TYPES II & III
116	CANTILEVERED SINGLE MAILBOX
203	SANITARY SEWER MANHOLE TYPES I & II
205	MANHOLE HEIGHTS
206A	STANDARD MANHOLE COVER & FRAME
209	MANHOLE CONNECTION DETAILS
213	SANITARY SEWER SERVICE LATERAL
215	SANITARY SEWER CROSSING
218	COUPLING FOR DISSIMILAR SANITARY SEWER PIPES
303	STORM DRAIN MANHOLE TYPES I & II
304A	TYPE III CATCH BASIN
308	CURB INLET FRAME, GRATE & HOOD
309	LOCAL DEPRESSION AT CATCH BASIN
403	FIRE HYDRANT
404	HYDRANT GUARD POSTS
405	HYDRANT PAD
406A	WATER SERVICE
412	RIGID INSULATION

**PART 2 – PRODUCTS** (Not Used)

**PART 3 – EXECUTION** (Not Used)

**END OF SECTION**



# PROJECT MANUAL

---

## GOODWIN ROAD RECONSTRUCTION Juneau, Alaska

CBJ Contract No. BE21-179

---

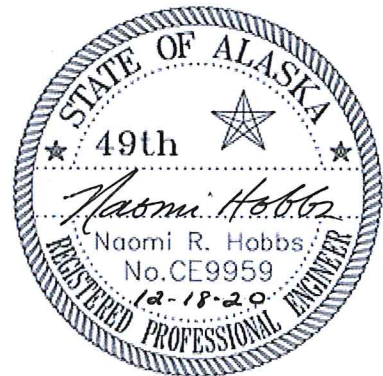

9085 Glacier Highway  
Juneau, AK 99801  
(907) 780-3533  
FAX (907) 780-3535  
tlockhart@dowl.com

## SPECIAL PROVISIONS

The Standard Specifications for Civil Engineering Projects and Subdivision Improvements December 2003 Edition, with fourteen Errata Sheets, as published by the City and Borough of Juneau, is part of these Contract Documents and shall pertain to all phases of the contract. The Standard Specifications for Civil Engineering Projects and Subdivision Improvements December 2003 Edition is available for a fee from the City and Borough of Juneau Engineering Contracts Office, (907) 586-0490, or you may view them online at: [www.juneau.org/engineering](http://www.juneau.org/engineering).

### Special Provisions - Table of Contents

<b>Section No.</b>	<b>Section Title</b>	<b>Page No.</b>
01010	Summary of Work	2
01025	Measurement and Payment	5
01550	Site Access and Storage	27
01570	Erosion and Sediment Control	27
02201	Clearing and Grubbing	27
02202	Excavation and Embankment	28
02203	Trenching	28
02204	Base Course	29
02402	Sanitary Sewer Manholes and Cleanouts	29
02404	Waterproof Pump Station	29
02501	Storm Sewer Pipe	30
02601	Water Pipe	31
02605	Water Services	32
02702	Construction Surveying	32
02709	Topsoil	32
02716	Storm and Sanitary Sewer Pipe Removal and Water Pipe Slurry	32
02722	Utility Conduit Relocation	34
02801	Asphalt Concrete Pavement	35
03302	Concrete Structures	37
03303	Sidewalk, Curb and Gutter	38
03305	Concrete Pavers	39

## **SPECIAL PROVISIONS**

*Add the following Section:*

### **SECTION 01010 - SUMMARY OF WORK**

#### **PART 1 - GENERAL**

##### **1.1 GENERAL**

- A. The WORK to be performed under this contract shall consist of furnishing all tools, equipment, materials, supplies, manufactured articles and furnishing all labor, transportation and services, including all fuel, power, water and essential communications and performing all WORK, or other operations required for the fulfillment of the contract in strict accordance with the Contract Documents. The WORK shall be complete, and all WORK, materials, and services, not expressly indicated or called for in the Contract Documents which may be necessary for the complete and proper construction of the WORK in good faith shall be provided by the CONTRACTOR as though originally so indicated, at no increase in cost to the OWNER.

##### **1.2 WORK COVERED BY CONTRACT DOCUMENTS**

- A. The WORK covered in the Contract Documents generally includes: Reconstruction of Goodwin Road from Blueberry Hills Road. WORK will include replacement of the water main and services, replacement of sanitary sewer force main and a segment of gravity sewer main, replacement of three sanitary sewer services, installation of two new sanitary sewer services, installation of sewer cleanouts, and installation of a new storm drain system. WORK will also include replacement of the roadway subbase to a depth of 18-inches, the installation of a new curb and gutter, and resurfacing with asphalt cement pavement.
- B. **SITE OF WORK.** The site of the WORK is on Goodwin Road in the Blueberry Hills Subdivision of West Juneau, Alaska.

##### **1.3 WORK BY OTHERS**

- A. The CONTRACTOR's attention is directed to the fact that work may be conducted at the site by other contractors during the performance of the WORK under this contract. The CONTRACTOR shall conduct its operations so as to cause a minimum of interference with the WORK of such other contractors, and shall cooperate fully with such contractors to provide continued safe access to their respective portions of the site, as required to perform work under their respective contracts.
- B. **Interference with Work on Utilities.** The CONTRACTOR shall cooperate fully with all utility forces of the OWNER or private agencies engaged in the relocation, altering, or otherwise rearranging of any facilities which interfere with the progress of the WORK, and shall schedule the WORK so as to minimize interference with said relocation, altering, or other rearranging of facilities.

##### **1.4 CONTRACTOR USE OF PROJECT SITE**

## **SPECIAL PROVISIONS**

- A. The CONTRACTOR's use of the Project site shall include construction operations and storage of materials, fabrication facilities, and field offices only in those areas identified on the Drawings.

### 1.5 OWNER USE OF THE PROJECT SITE

- A. The OWNER may utilize all or part of the existing site during the entire period of construction for the conduct of the OWNER's normal operations. The CONTRACTOR shall cooperate and coordinate with the ENGINEER to facilitate the OWNER's operations and to minimize interference with the CONTRACTOR's operation at the same time. In any event, the OWNER shall be allowed access to the Project site during the period of construction.

### 1.6 PROJECT MEETINGS

- A. Pre-Construction Conference

- 1. Prior to the commencement of WORK at the site, a Pre-Construction Conference will be held at a mutually agreed time and place which shall be attended by the CONTRACTOR's Project Manager, its Superintendent, and its Subcontractors as the CONTRACTOR deems appropriate. Other attendants will be:
  - a. ENGINEER and Inspector.
  - b. Representatives of OWNER.
  - c. Governmental representatives as appropriate.
  - d. Others as requested by CONTRACTOR, OWNER, or ENGINEER.
- 2. Unless previously submitted to the ENGINEER, the CONTRACTOR shall bring to the Pre-Construction Conference one copy each of the following:
  - a. Plan of Operation.
  - b. Project Overview Bar Chart Schedule.
  - c. Procurement schedule of major equipment and materials and items requiring long lead time.
  - d. Shop Drawing/Sample/Substitute or "Or Equal" submittal schedule.
  - e. Name and telephone number of CONTRACTOR's Project Supervisor.
  - f. Erosion Control Plan with Storm Water Pollution Prevention Plan.
- 3. The purpose of the Pre-Construction Conference is to designate responsible personnel and establish a working relationship. Matters requiring coordination will be discussed and procedure for handling such matters established. The complete agenda will be furnished to the CONTRACTOR prior to the meeting date. The CONTRACTOR should be prepared to discuss all of the items listed below:
  - a. Status of CONTRACTOR's insurance and bonds.
  - b. CONTRACTOR's tentative schedules.
  - c. Transmittal, review, and distribution of CONTRACTOR's submittals.
  - d. Processing applications for payment.
  - e. Maintaining record documents.

## **SPECIAL PROVISIONS**

- f. Critical WORK sequencing.
  - g. Field decisions and Change Orders.
  - h. Use of Project site, office and storage areas, security, housekeeping, and OWNER's needs.
  - i. Major equipment deliveries and priorities.
  - j. CONTRACTOR's assignments for safety and first aid.
4. The OWNER will preside at the Pre-Construction Conference and will arrange for keeping and distributing the minutes to all persons in attendance.
  5. The CONTRACTOR and its Subcontractors should plan on the conference taking no longer than three hours. Items listed in paragraph 3 will be covered as well as a review of the Drawings and Specifications with the ENGINEER and OWNER.

### **B. Progress Meetings**

1. The CONTRACTOR shall schedule and hold regular on-site progress meetings at least weekly and at other times as requested by the ENGINEER, or as required by the progress of the WORK. The CONTRACTOR, ENGINEER, and all Subcontractors active on the site must attend each meeting. The CONTRACTOR may at its discretion request attendance by representatives of its Suppliers, manufacturers, and other Subcontractors.
2. The ENGINEER shall conduct the meeting and will arrange for recording and distributing the minutes. The purpose of the meetings will be to review the progress of the WORK, maintain coordination of efforts, discuss changes in scheduling, and resolve other problems which may develop. During each meeting, the CONTRACTOR is required to present any issues which may impact the WORK, with a view toward resolving these issues expeditiously.

## **1.7 DEFINITIONS APPLICABLE TO TECHNICAL SPECIFICATIONS**

### **A. The following words have the meaning defined in the Technical Portions of the WORK:**

1. **Furnish** - means to supply and deliver to the site, to unload and unpack ready for assembly, installation, testing, and start-up.
2. **Indicated** - is a word used to direct the CONTRACTOR to information contained on the drawings or in the Specifications. Terms such as "shown", "noted", "scheduled", and "specified" also may be used to assist in locating information but no limitation of location is implied or intended.
3. **Install** - defines operations at the site including assembly, erection, placing, anchoring, applying, shaping to dimension, finishing, curing, protecting, and cleaning, ready for the OWNER's use.
4. **Installer** - a person or firm engaged by the CONTRACTOR or its subcontract, or any Subcontractor, for the performance of installation, erection, or application WORK at the site. Installers must be expert in the operations they are engaged to perform.
5. **Provide**- is defined as furnish and install, ready for the intended use.

## **SPECIAL PROVISIONS**

### **PART 2 - PRODUCTS (Not Used)**

### **PART 3 - EXECUTION (Not Used)**

### **END OF SECTION**

*Add the following Section:*

### **SECTION 01025 – MEASUREMENT AND PAYMENT**

#### **PART 1 - GENERAL**

##### **1.1 SCOPE**

- A. Payment for the various items of the Bid Schedule, as further specified herein, shall include all compensation to be received by the CONTRACTOR for furnishing all tools, equipment, supplies, and manufactured articles, and for all labor, operations, and incidentals appurtenant to the items for WORK being described, as necessary to complete the various items of the WORK all in accordance with the requirements of the Contract Documents, including all appurtenances thereto, and including all costs of permits and cost of compliance with the regulations of public agencies having jurisdiction, including Safety and Health Requirements of Occupational Safety and Health Administration of the U.S. Department of Labor (OSHA) and Occupational Safety and Health Standards of the Alaska Department of Labor, Division of Labor Standards and Safety.
- B. No separate payment will be made for any Pay Item that is not specifically set forth in the Bid Schedule, and all costs therefore shall be included in the prices named in the Bid Schedule for the various appurtenant items of WORK.
- C. In addition to the other incidental items of WORK listed elsewhere in the contract, the following items shall also be considered as incidental to the WORK:
  - 1. Maintenance of all services through the Project area including power, water, storm and sanitary sewers, garbage pickup, mail delivery, and emergency vehicles.
  - 2. Traffic control, including flaggers, and installation and maintenance of traffic control devices in accordance with the Manual of Uniform Traffic Control Devices – Millennium Edition (MUTCD) and the current AKDOT&PF supplements.
  - 3. Repair or replacement of existing adjacent facilities including piping, landscaping, steel, timber, concrete and asphalt items, if damaged by the CONTRACTOR.
  - 4. Final clean-up and site restoration.
  - 5. All WORK necessary for coordination of work to be accomplished by the private utility companies and property owners within the Project limits.
  - 6. Removal and replacement of survey monuments and markers disturbed during construction, whether shown on the Drawings or not.
  - 7. Watering of the roadway as necessary for dust control.

## **SPECIAL PROVISIONS**

8. Removal and disposal of the existing sign assemblies within the Project limits not shown to remain, or as indicated on the Drawings.
9. All fittings required for storm, water and sanitary sewer pipes.
10. Usable material from excavation placed in the roadway under the shot rock borrow or within the fill slope outside the limits of the road and sidewalk prism.
11. Crack sealing all joints following paving operations.
12. All WORK required to notify utility users of pending utility shutdowns.
13. All sawcutting required for connections to existing asphalt pavement surfaces, and concrete curbs.
14. Shoring and supporting existing above ground utility poles.
15. Regrading gravel driveways beyond back of existing curb.
16. Adjusting existing storm manhole frame and grate at STA "G" 10+43.61, 43.61'LT.
17. Removal and replacement of landscaping at STA "G" 13+25 LT for water service connection.

### 1.2 MOBILIZATION (Pay Item No. 1505.1) PRICE BASED ON LUMP SUM PAY UNIT

- A. Measurement for payment for Mobilization will be based upon the completion of the entire WORK as a Lump Sum Pay Unit, complete, all in accordance with the requirements of the Contract Documents.
- B. Payment for Mobilization will be made at the amount shown on the Bid Schedule under Pay Item No. 1505.1, which payment will constitute full compensation for all WORK described in Section 01505 - Mobilization, as shown on the Drawings and as directed by the ENGINEER.
- C. Partial payments will be made as the WORK progresses as follows:
  1. When 5% of the total original contract amount is earned from other Pay Items, 50% of the amount bid for Mobilization, or 5% of the original contract amount, whichever is lesser, will be paid.
  2. When 10% of the total original contract amount is earned from other Pay Items, 100% of the amount bid for Mobilization, or 10% of the original contract amount, whichever is lesser, will be paid.
  3. Upon completion of all WORK on the Project, payment of any amount bid for Mobilization in excess of 10% of the total contract amount will be paid.

### 1.3 EROSION AND SEDIMENT CONTROL (Pay Item No. 1570.1) PRICE BASED ON LUMP SUM PAY UNIT

- A. Measurement for payment for Erosion and Sediment Control will be based upon the completion of the entire WORK as a Lump Sum Pay Unit, complete, all in accordance with the requirements of the Contract Documents.
- B. WORK under this Pay Item includes all requirements described in Section 01570, including but not limited obtaining all necessary permits for storm water control as required by Alaska Department of Conservation and the

## **SPECIAL PROVISIONS**

Environmental Protection Agency. This includes furnishing, installing and maintaining all measures required by these permits.

- C. Payment for Erosion and Sediment Control will be made at the amount shown on the Bid Schedule under Pay Item No. 1570.1, which payment will constitute full compensation for all WORK described in Section 01570 – Erosion and Sediment Control, as shown on the Drawings and as directed by the ENGINEER.

### 2.1 HAND CLEARING (Pay Item No. 2201.1) PRICE BASED ON LUMP SUM PAY UNIT

- A. Measurement of payment for Hand Clearing will be based upon the completion of the entire WORK as a Lump Sum Pay Unit, complete, all in accordance with the requirements of the Contract Documents.
- B. WORK under this Pay Item includes trimming and disposal of tree branches overhanging pathway from ~STA “G” 14+30 to ~STA “G” 15+75 along project left as directed by the ENGINEER.
- C. Payment for Hand Clearing will be made at the amount shown on the Bid Schedule under Pay Item No. 2201.1, which payment will constitute full compensation for all WORK described in Section 02201 – Clearing and Grubbing, as shown on the Drawings and as directed by the ENGINEER.

### 2.2 EXCAVATION (Pay Item No. 2202.1) PRICE BASED ON QUANTITY, CUBIC YARD

- A. Measurement for payment for Excavation will be based on the number of cubic yards of unclassified material actually excavated, as determined by the average end area method. Where impractical to measure by the average end area method, the ENGINEER may approve other acceptable methods involving three-dimensional measurements. Excavation outside of the subcut limits indicated in the Drawings, or as directed by the ENGINEER will not be measured for payment.
- B. No deduction in the measurement for Excavation will be made for the trenching required for pipe and structure installations above the bottom of, or within the subcut limits as shown on the Typical Sections.
- C. Measurement for payment may be selected by the CONTRACTOR from one of the following methods:
  - 1. From actual cross sections taken by the CONTRACTOR’s surveyor (following pavement and concrete curbing, slabs or sidewalk removal where present), with the lower limits determined by a line 18” below finish grade elevations, as indicated on the Typical Sections, or as directed by the ENGINEER.
  - 2. The CONTRACTOR may review and utilize the ENGINEER's design earthwork quantity computations in lieu of providing its own quantity determinations.
- D. The following will not be measured for direct payment; the cost of such WORK will be considered incidental to other WORK under the contract:



## SPECIAL PROVISIONS

1. Overburden and other spoil material from borrow sources.
2. Removal of water by aeration of material to obtain required moisture content.
3. Any volumes of water or other liquid material.
4. Material used for the purpose other than directed.
5. Roadbed material scarified in place and not removed.
6. Material excavated when benching.
7. Slide or slipout material attributable to the carelessness of the CONTRACTOR.
8. The volume of conserved materials stockpiled at the option of the CONTRACTOR.
9. Placement of usable, or otherwise suitable material from excavation, as determined by the ENGINEER, into the new roadway and sidewalk as embankment or selected embankment, or as embankment for any areas outside the roadway subcut within the project limits.

- E. Payment for Excavation will be made at the Unit Price named in the Bid Schedule under Pay Item No. 2202.1, which payment will constitute full compensation for all WORK described in Section 02202 - Excavation and Embankment, as shown on the Drawings and as directed by the ENGINEER.

### 2.3 SHOT ROCK BORROW (Pay Item No. 2202.2) PRICE BASED ON QUANTITY, CUBIC YARD

- A. Shot Rock Borrow will be measured by the number of cubic yards of material in place as determined by the average end area method and will be determined on a neatline basis. Where impractical to measure by the average end area method, the ENGINEER may approve other acceptable methods involving three-dimensional measurements. Embankment outside of the lines, grades and cross sections indicated in the Drawings or as directed by the ENGINEER will be deducted from borrow quantities for pay purposes.
- B. No Shot Rock Borrow shall be measured for payment below a line 18 inches below finish grade.
- C. Payment for Shot Rock Borrow will be made at the Unit Price named in the Bid Schedule under Pay Item No. 2202.2, which payment will constitute full compensation for all WORK described in Section 02202 - Excavation and Embankment, as shown on the Drawings as and as directed by the ENGINEER.

### 2.4 SIDESLOPES AND DITCH GRADING (Pay Item No. 2202.3) PRICE BASED ON LUMP SUM PAY UNIT

- A. Measurement for payment for Sideslopes and Ditch Grading will be based on the completion of the entire WORK as a Lump Sum Pay Unit, complete, including all excavation and placement of useable material from excavation into the sideslope, ditch, and swale areas, all in accordance with the requirements of the Contract Documents.
- B. This Pay Item will include all WORK, including excavation, backfill with usable material from roadway and trench excavation, and all grading outside the shoulder

## **SPECIAL PROVISIONS**

limits as necessary to construct sideslopes, ditches, swales, and other graded areas, as shown on the Drawings and as directed by the ENGINEER.

- C. Payment for Sideslopes and Ditch Grading will be made at the amount named in the Bid Schedule under Pay Item No. 2202.3, which payment will constitute full compensation for all WORK described in Section 02202 – Excavation and Embankment, as shown on the Drawings and as directed by the ENGINEER.

### 2.5 MINING AREA RESTORATION & ROAD CLEANING GUARANTEE (Pay Item No. 2202.4) PRICE BASED ON CONTINGENT SUM PAY UNIT

- A. Measurement for this Item will be made as a Contingent Sum Pay Unit for completion of Mining Area Restoration and Road Cleaning.
- B. The CONTRACTOR shall be responsible for removal of dirt, mud, rocks and other debris from CBJ and State Right-of-Ways accumulated from the hauling and quarry operations. It is the intent that the traveled public way be kept as clean as practical to minimize dust and to avoid unsafe traffic conditions. If the CONTRACTOR fails to perform necessary road cleaning, the CBJ may hire outside forces to perform the work and deduct the cost from this contingent sum item.
- C. The CONTRACTOR shall be responsible for restoration of their mining area in accordance to the conditions of the material source used and mining plan submitted. If the CONTRACTOR fails to perform the required mining area restoration, the CBJ may hire outside forces to perform the work and deduct the cost from this contingent sum item.
- D. Release of final payment for Mining Area Restoration and Road Cleaning Guarantee will be made upon determination of completeness by the ENGINEER after deduction of OWNER incurred costs for necessary road cleaning and/or mining area restoration not completed by the CONTRACTOR.
- E. Payment for Mining Area Restoration and Road Cleaning Guarantee will be made at the amount named in the Bid Schedule under Pay Item No. 2202.4, which payment will constitute full compensation for all WORK described in section 02202 – Excavation and Embankment, as shown on the Drawings and as directed by the ENGINEER.

### 2.6 2-INCH MINUS SHOT ROCK w/ BASE COURSE (Pay Item No. 2204.1) PRICE BASED ON QUANTITY, CUBIC YARD

- A. 2-Inch Minus Shot Rock w/ Base Course will be measured by the number of cubic yards of material in place as determined by the average end area method and will be determined on a neatline basis. Where impractical to measure by the average end area method, the ENGINEER may approve other acceptable methods involving three-dimensional measurements. Material outside of the lines, grades and cross sections indicated in the Drawings, or as directed by the ENGINEER, will be deducted from 2-Inch Minus Shot Rock w/Base Course quantities for pay purposes.

## **SPECIAL PROVISIONS**

- B. Base Course, Grading D-1, may be used under the driveways and curbing as a substitute for 2-Inch Minus Shot Rock w/ Base Course as a no cost change. This material will be measured for payment under this Pay Item.
  - C. Water needed for compaction and added to the base material on the grade will be considered incidental.
  - D. 2-Inch Minus Shot Rock will be placed and compacted into a layer 4- inches to 5- inches thick, and covered with Base Course, to a total thickness of 6-inches for the area Both of these materials will be measured for payment under this Pay Item.
  - E. Payment for 2-Inch Minus Shot Rock w/ Base Course, will be made at the Unit Price named in the Bid Schedule under Pay Item No. 2204.1, which payment will constitute full compensation for all WORK described in Section 02204 – Base Course, as shown on the Drawings and as directed by the ENGINEER.
- 2.7 LOCATE SANITARY SEWER SERVICES (Pay Item No.2401.1) PRICE BASED ON LUMP SUM PAY UNIT
- A. Measurement and payment for Locate Sanitary Sewer Services will be based upon the completion of the entire WORK as a Lump Sum Pay Unit, complete, all in accordance with the requirements of the Contract Documents.
  - B. The WORK under this Pay Item includes all excavation and backfill, and other WORK necessary to determine the location of all existing sanitary sewer services prior to installation of the new sewer services. Elevation checks shall be made with new water and storm drain piping to determine if pipe conflicts exist. If pipe conflicts exist, data shall be submitted to the ENGINEER so that a solution can be provided to the Contractor.
  - C. Payment for Locate Sanitary Sewer Services will be made at the Unit Price named in the Bid Schedule under Pay Item No, 2401.1, which payment will constitute full compensation for all WORK described in Section 02401 – Sanitary Sewer Pipe, as shown on the Drawings and as directed by the ENGINEER.
- 2.8 SANITARY SEWER PIPE 8-INCH PVC (Pay Item No. 2401.2) PRICE BASED ON QUANTITY, LINEAR FEET
- A. Sanitary Sewer Pipe 8-Inch PVC will be measured along the slope of the pipe in feet, from center to center of manholes, from center of manholes to end of pipe, or to limits of payment as shown on the Drawings. The aggregate laid lengths of wyes will not be deducted from lengths of pipes so measured.
  - B. WORK under this Pay Item will include SS-2.
  - C. Trench excavation, bedding, backfill, and warning tape, will not be paid for but will be considered incidental to the WORK. The connection to MH-4 and MH-5 will also be considered incidental to the WORK.

## SPECIAL PROVISIONS

- D. Payment for Sanitary Sewer Pipe 8-Inch PVC will be made at the Unit Price named in the Bid Schedule under Pay Item No. 2401.2, which payment will constitute full compensation for all WORK described in Section 02401 – Sanitary Sewer Pipe, as shown on the Drawings and as directed by the ENGINEER.
- 2.9 SANITARY SEWER PIPE 6-INCH HDPE FORCE MAIN (Pay Item No. 2401.3) PRICE BASE ON QUANTITY, LINEAR FEET
- A. Sanitary Sewer Pipe 6-Inch HDPE Force Main will be measured along the slope of the pipe in feet, from center of manhole MH-1 to wall of existing lift station, or to limits of payment as shown on the Drawings. The aggregate laid lengths of fittings will not be deducted from the lengths of pipe so measured.
- B. WORK under this Pay Item will include SS-1.
- C. Cleaning and testing of sewer pipe will not be measured for payment but will be considered incidental to other WORK under Section 02401 – Sanitary Sewer Pipe.
- D. WORK under this Pay Item includes connection of SS-1 to existing vertical 4-inch ductile iron flange within valve vault, and a link-seal penetration of the valve vault wall. WORK will include all restrained fittings, stainless steel hardware, reducer, grout, equipment and labor as required.
- E. Pumping of vault, backfill, bedding and installation of the tracer wire will not be measured for payment, but will be considered incidental to other WORK under the Contract.
- F. The WORK will include altering existing MH-1 inlet for installation of SS-1 and link-seal connection to manhole. If a ductile iron sleeve is employed for the manhole connection, it shall be considered incidental to the WORK.
- G. Payment for 6-Inch HDPE Force Main will be made at the Unit Price named in the Bid Schedule under Pay Item No. 2401.3, which payment will constitute full compensation for all WORK described in Section 02401 – Sanitary Sewer Pipe, as shown on the Drawings and as directed by the ENGINEER.
- 2.10 SANITARY SEWER SERVICE LATERAL WITH CLEANOUT, 6-INCH (Pay Item No. 2401.4) PRICE BASED ON QUANTITY, EACH
- A. Sanitary Sewer Service Lateral with Cleanout will be measured per each, complete in place, including pipe, wyes, cleanouts and ductile iron or cast iron frame and cover, with “SEWER” cast on it, fittings and adapters, as required to connect to the mainline sewer and existing service at the property line in accordance with the requirements of the Contract Documents.
- B. Trench excavation, bedding, backfill, warning tape, trench shoring and bracing, will be considered incidental to the WORK.
- C. Payment for Sanitary Sewer Service Lateral with Cleanout, 6-Inch will be made at the Unit Price named in the Bid Schedule under Pay Item No. 2401.4, which

## **SPECIAL PROVISIONS**

payment will constitute full compensation for all WORK described in Section 02401 – Sanitary Sewer Pipe, as shown on the Drawings and as directed by the ENGINEER.

**2.11 SANITARY SEWER SERVICE CLEANOUT (Pay Item No. 2401.5) PRICE BASE ON QUANTITY, EACH**

- A. Sanitary Sewer Service Cleanout will be measured per each, complete in place, including cleanouts and ductile iron or cast iron frame and cover, with “SEWER” cast on it, non-shear coupling and fittings, as required to connect to existing sanitary sewer service at the property line in accordance with the requirements of the Contract Documents.
- B. Trench excavation, bedding, backfill, warning tape, trench shoring and bracing, will be considered incidental to the WORK.
- C. Cleanouts installed under Pay Item 2401.4 will not be measured for payment under this Pay Item.
- D. Payment for Sanitary Sewer Service Cleanout will be made at the Unit Price named in the Bid Schedule under Pay Item No. 2401.5, which payment will constitute full compensation for all WORK described in Section 02401 – Sanitary Sewer Pipe, as shown on the Drawings and as directed by the ENGINEER.

**2.12 SANITARY SEWER MANHOLE, TYPE I (Pay Item No. 2402.1) PRICE BASED ON QUANTITY, EACH**

- A. Sanitary Sewer Manhole, Type I with Fiberglass Base Liner will be measured per each, complete in place, including new frame and cover, waterproofing, new adjusting rings, new recycled rubber rings, and all earthwork for manhole MH-5.
- B. All WORK required to reset the frame and cover to grade if not installed to proper grade tolerances during paving operations, including construction of a concrete transition slab with pavement overlay, if necessary, will be considered incidental to other work under this Contract.
- C. Payment for Sanitary Sewer Manhole, Type I will be made at the Unit Price named in the Bid Schedule under Pay Item No. 2402.1, which payment will constitute full compensation for all WORK described in Section 02402–Sanitary Sewer Manholes and Cleanouts, as shown on the Drawings, and as directed by the ENGINEER.

**2.13 REMOVE AND REPLACE SANITARY SEWER MANHOLE CONE (Pay Item No. 2402.2) PRICE BASED ON LUMP SUM PAY UNIT**

- A. Measurement for payment of Remove and Replace Sanitary Sewer Manhole Cone will be based upon the completion of the entire WORK as a Lump Sum Pay Unit, complete, all in accordance with the requirements of the Contract Documents.

## SPECIAL PROVISIONS

- B. WORK under this Pay Item includes all excavation, backfill, waterproofing, including new eccentric cone, new frame and cover, new adjusting rings, and new recycled rubber rings for manhole MH-2.
  - C. CONTRACTOR shall field-verify dimensions of existing manholes to ensure compatibility with new cones prior to ordering new cones. Any retrofitting of existing manholes required to receive the new cones shall be considered incidental to the WORK.
  - D. Payment for Remove and Replace Sanitary Sewer Manhole Cone will be made at the Unit Price named in the Bid Schedule under Pay Item No. 2402.2, which payment will constitute full compensation for all WORK described in Section 02402 - Sanitary Sewer Manholes and Cleanouts, as shown on the Drawings and as directed by the ENGINEER.
- 2.14 RECONSTRUCT SANITARY SEWER MANHOLE (Pay Item No. 2402.3) PRICE BASED ON QUANTITY, EACH
- A. Reconstruct Sanitary Sewer Manhole will be measured per each, complete in place, including new frame and cover, new adjusting rings, waterproofing, new recycled rubber rings, concrete collar, if required, and all earthwork.
  - B. WORK under this Pay Item includes existing manholes MH-3 and MH-4.
  - C. Payment for Reconstruct Sanitary Sewer Manhole will be made at the Unit Price named in the Bid Schedule under Pay Item No. 2402.3, which payment will constitute full compensation for all WORK described in Section 02402–Sanitary Sewer Manholes and Cleanouts, as shown on the Drawings, and as directed by the ENGINEER.
- 2.15 ADJUST SANITARY SEWER MANHOLE TO GRADE (Pay Item No. 2402.4) PRICE BASED ON QUANTITY, EACH
- A. Adjust Sanitary Manhole to Grade will be measured per each, complete in place, including resetting existing frame and cover, new adjusting rings, new recycled rubber rings, concrete collar, if required, and all earthwork.
  - B. WORK under this Pay Item includes existing manhole MH-1.
  - C. Payment for Adjust Sanitary Manhole to Grade will be made at the Unit Price named in the Bid Schedule under Pay Item No. 2402.4, which payment will constitute full compensation for all WORK described in Section 02402–Sanitary Sewer Manholes and Cleanouts, as shown on the Drawings, and as directed by the ENGINEER.
- 2.16 WATERPROOF LIFT STATION (Pay Item No. 2404.1) PRICE BASED ON LUMP SUM PAY UNIT

## SPECIAL PROVISIONS

- A. Waterproof Lift Station will be based upon the completion of the entire WORK as a Lump Sum Pay Unit, complete, all in accordance with the requirements of the Contract Documents.
  - B. WORK under this Pay Item will include installation of a bituminous coating from the base to the top of vault on the three uphill walls of the lift station. The lift station is assumed to be 6-1/2' by 13' by 6' tall.
  - C. WORK will also include coring and installation of 6" PVC drain pipe on downhill side.
  - D. All excavation and 2-inch backfill will not be measured for payment, but will be considered incidental to the WORK.
  - E. Pumping of lift station for installation of 6" PVC drain will be considered incidental to the WORK.
  - F. Installation of an 18-lb zinc anode will be measured for payment under its respective Pay Item.
  - G. Payment for Waterproof Lift Station will be made at the Unit Price named in the Bid Schedule under Pay Item No. 2404.1, which payment will constitute full compensation for all WORK described in Section 02404–Pump Station, as shown on the Drawings, and as directed by the ENGINEER.
- 2.17 12-INCH PIPE CULVERT (Pay Item No. 2501.1) PRICE BASED ON QUANTITY, LINEAR FOOT
- A. Culvert Pipes, including all coupling bands, bends and other items necessary for the proper joining of the culvert pipe sections, will be measured by the staked length in linear feet.
  - B. Pipes for storm drains shall be measured by the staked length, from center to center of structures or to ends of pipe if no structure is present. No deduction shall be made for footage through inlets, catch basins or manholes.
  - C. Branch connections, coupling adapters and bends will be included in the linear foot measurement for conduit.
  - D. Trench excavation, bedding, backfill and imported backfill will not be measured for payment, but will be considered incidental to the WORK.
  - E. Payment for 12-Inch Pipe Culvert will be made at the Unit Price named in the Bid Schedule under Pay Item No. 2501.1, which payment will constitute full compensation for all WORK described in Section 02501 - Storm Sewer Pipe, as shown on the Drawings and as directed by the ENGINEER.
- 2.18 18-INCH PIPE CULVERT (Pay Item No. 2501.2) PRICE BASED ON QUANTITY, LINEAR FOOT

## **SPECIAL PROVISIONS**

- A. Culverts Pipes, including all coupling bands, bends and other items necessary for the proper joining of the culvert pipe sections, will be measured by the staked length in linear feet.
  - B. Pipes for storm drains shall be measured by the staked length, from center to center of structures or to ends of pipe if no structure is present. No deduction shall be made for footage through inlets, catch basins or manholes.
  - C. Branch connections, coupling adapters and bends will be included in the linear foot measurement for conduit.
  - D. Trench excavation, bedding, backfill and imported backfill will not be measured for payment, but will be considered incidental to the WORK.
  - E. Payment for 18-Inch Pipe Culvert will be made at the Unit Price named in the Bid Schedule under Pay Item No. 2501.2, which payment will constitute full compensation for all WORK described in Section 02501 - Storm Sewer Pipe, as shown on the Drawings and as directed by the ENGINEER.
- 2.19 24-INCH PIPE CULVERT (Pay Item No. 2501.3) PRICE BASED ON QUANTITY, LINEAR FOOT
- A. Culverts Pipes, including all coupling bands, bends and other items necessary for the proper joining of the culvert pipe sections, will be measured by the staked length in linear feet.
  - B. Pipes for storm drains shall be measured by the staked length, from center to center of structures or to ends of pipe if no structure is present. No deduction shall be made for footage through inlets, catch basins or manholes.
  - C. Branch connections, coupling adapters and bends will be included in the linear foot measurement for conduit.
  - D. Trench excavation, bedding, backfill and imported backfill will not be measured for payment, but will be considered incidental to the WORK.
  - E. Payment for 24-Inch Pipe Culvert will be made at the Unit Price named in the Bid Schedule under Pay Item No. 2501.3, which payment will constitute full compensation for all WORK described in Section 02501 - Storm Sewer Pipe, as shown on the Drawings and as directed by the ENGINEER.
- 2.20 6-INCH UNDERDRAIN (Pay Item No. 2501.4) PRICE BASED ON QUANTITY, LINEAR FOOT
- A. Underdrain pipe, including all coupling bands and other items necessary for the proper joining of the pipe sections, will be measured by the staked length.
  - B. Underdrain pipe will be measured from center of structures of ends of pipe, as shown on the Drawings or as directed by the ENGINEER.



## SPECIAL PROVISIONS

- C. WORK will include the cleanout to be installed on the underdrain at ~STA “G” 12+08.4, 19.4’ LT.
  - D. Pipe perforations, 2-inch minus shot rock, filter cloth and end caps will not be measured for payment, but will be considered incidental to the WORK.
  - E. WORK will include all excavation, bedding and backfill required.
  - F. 6-Inch Underdrain shall be installed at the location shown on the Drawings, or as directed by the ENGINEER.
  - G. Payment for 6-Inch Underdrain will be made at the Unit Price named in the Bid Schedule under Pay Item No. 2501.4, which payment constitutes full compensation for all WORK described in Section 02501 – Storm Sewer Pipe, as shown on the Drawings, and as directed by the ENGINEER.
- 2.21 15-INCH PVC SLIP LINE CULVERT (Pay Item No 2501.5) PRICE BASED ON LUMP SUM PAY UNIT
- A. Measurement and payment for 15-Inch PVC Slip Line Culvert will be based upon the completion of the entire WORK as a Lump Sum Pay Unit, complete, all in accordance with the requirements of the Contract Documents.
  - B. WORK under this Pay Item will include SD-4 and SD-7.
  - C. Cleaning of existing host pipe, excavation and backfilling of the slip line pit, all grout required to fill annular space between host pipe and sliplined pipe on upstream end, connection to catch basins, and all other WORK or materials necessary to install the 15-inch slip line culvert will be considered incidental to other WORK under this section.
  - D. Payment for 15-Inch PVC Slip Line Culvert will be made at the Unit Price named in the Bid Schedule under Pay Item No. 2501.5, which payment will constitute full compensation for all WORK described in Section 02501 – Storm Sewer Pipe, as shown on the Drawings and as directed by the ENGINEER.
- 2.22 21-INCH PVC SLIP LINE CULVERT (Pay Item No 2501.6) PRICE BASED ON LUMP SUM PAY UNIT
- A. Measurement and payment for 21-Inch PVC Slip Line Culvert will be based upon the completion of the entire WORK as a Lump Sum Pay Unit, complete, all in accordance with the requirements of the Contract Documents.
  - B. WORK under this Pay Item will include SD-10.
  - C. Cleaning of existing host pipe, excavation and backfilling of the slip line pit, all grout required to fill annular space between host pipe and SD-10 on upstream end, connection to catch basin CB-7, and all other WORK or materials necessary to install the 21-inch slip line culvert will be considered incidental to other WORK under this section.

## SPECIAL PROVISIONS

- D. Payment for 21-Inch PVC Slip Line Culvert will be made at the Unit Price named in the Bid Schedule under Pay Item No. 2501.6, which payment will constitute full compensation for all WORK described in Section 02501 – Storm Sewer Pipe, as shown on the Drawings and as directed by the ENGINEER.
- 2.23 STORM DRAIN MANHOLE, TYPE I (Pay Item No. 2502.1) PRICE BASED ON QUANTITY, EACH
- A. Storm Drain Manholes, Type I will be measured per each, complete in place, including transition slab, if required, and all earthwork, adjusting rings, frames and grates.
- B. WORK under this Pay Item will include CB-2, CB-3, CB-4, CB-5, CB-6 and CB-7.
- C. Payment for Storm Drain Manhole, Type I will be made at the Unit Price named in the Bid Schedule under Pay Item No. 2502.1 which payment will constitute full compensation for all WORK described in Section 02502 – Storm Sewer Manholes, Inlets and Catch Basins, as shown on the Drawings and as directed by the ENGINEER.
- 2.24 CATCH BASIN, TYPE III (Pay Item No. 2502.2) PRICE BASED ON QUANTITY, EACH
- A. Catch Basins, Type III will be measured per each, complete in place, including all earthwork, frames and grates or covers.
- B. WORK will include the associated culvert connections as required for CB-1.
- C. Payment for Catch Basin, Type III will be made at the Unit Price named in the Bid Schedule under Pay Item No. 2502.2, which payment will constitute full compensation for all WORK described in Section 02502 - Storm Sewer Manholes, Inlets and Catch Basins, as shown on the Drawings and as directed by the ENGINEER.
- 2.25 10-INCH HDPE WATER PIPE (Pay Item No. 2601.1) PRICE BASED ON QUANTITY, LINEAR FOOT
- A. Measurement of water pipe will be made along the slope of the water pipe from the centers of fittings and valves in linear feet. No deduction in length will be made for valves, fittings, or fused reducers. All fittings, other than valves, required for satisfactory installation of water pipe will be considered incidental to this Pay Item.
- B. All trench excavation, bedding, backfill, imported backfill, sheeting and bracing, dewatering, cleaning and testing, warning tape, tracer wire, concrete thrust blocks, compaction and all other items necessary for a complete installation will not be measured for payment, but will be considered incidental to other WORK.
- C. WORK under this Pay Item includes the installation of water pipe termination tracer wire boxes where shown on the Drawings, including the valve box, pressure treated board, stainless steel wire staples, and tracer wire.

## SPECIAL PROVISIONS

- D. Payment for 10-Inch HDPE Water Pipe will be made at the Unit Price named in the Bid Schedule under Pay Item No. 2601.1, which payment will constitute full compensation for all WORK described in Section 02601 - Water Pipe, as shown on the Drawings and as directed by the ENGINEER.
- 2.26 INSTALL CORROSION PROTECTION ANODE (Pay Item No. 2601.2) PRICE BASED ON QUANTITY, EACH
- A. Measurement for payment for Install Corrosion Protection Anode will be based on the actual quantity of each 18-lb zinc anodes furnished and installed in accordance with the requirements of the Contract Documents.
  - B. WORK under this pay item includes all labor, equipment, materials, excavation, backfill, and all other WORK necessary to furnish and install galvanic anodes in the locations shown on the plans and as directed by the ENGINEER. The fire hydrant anodes will be measured for payment under this Pay Item.
  - C. Payment for Install Corrosion Protection Anode will be made at the amount named in the Bid Schedule under Pay Item No. 2601.2, which payment will constitute full compensation for all WORK described in Section 02601 – Water Pipe, as shown on the Drawings and as directed by the ENGINEER.
- 2.27 CONNECT TO EXISTING WATER PIPE (Pay Item No. 2601.3) PRICE BASED ON LUMP SUM PAY UNIT
- A. Measurement for payment for Connect to Existing Water Pipe will be based upon the completion of the entire WORK as a Lump Sum Pay Unit, complete, all in accordance with the requirements of the Contract Documents.
  - B. The WORK under this Pay Item included all excavation and backfill, cutting and removing sections of existing water pipe, and all materials including new couplers, bands, fittings, ductile iron sleeves, joint restraints, and all other WORK and materials necessary to complete connections of new 10” HDPE to existing 10” HDPE.
  - C. Payment for Connect to Existing Water Pipe will be made at the amount named in the Bid Schedule under Pay Item No. 2601.3, which payment will constitute full compensation for all WORK described in Section 02601 - Water Pipe, as shown on the Drawings and as directed by the ENGINEER.
- 2.28 TEMPORARY WATER SYSTEM (Pay Item No. 2601.4) PRICE BASED ON LUMP SUM PAY UNIT
- A. Measurement for payment for Temporary Water System will be based upon the completion of the entire WORK as a Lump Sum Pay Unit, complete, all in accordance with the requirements of the Contract Documents.
  - B. WORK will include all piping, valves, fittings, joint restraints, excavation, compaction, bedding, backfill, imported backfill, sheeting and bracing,

## **SPECIAL PROVISIONS**

dewatering, disinfection, testing, thrust blocks, and all other items of WORK necessary for complete installation and removal of a temporary water system.

- C. WORK will also include protecting the temporary water system from vehicle traffic as required.
- D. Payment for Temporary Water System will be made at the Unit Price named in the Bid Schedule under Pay Item No. 2601.4, which payment will constitute full compensation for all WORK described in Section 02601 - Water Pipe, as shown on the Drawings and as directed by the ENGINEER.

### 2.29 FIRE HYDRANT ASSEMBLY WITH GUARD POSTS (Pay Item No. 2603.1) PRICE BASED ON QUANTITY, EACH

- A. Measurement for payment of Fire Hydrant Assembly with Guard Posts will be based on the actual number of fire hydrant assemblies satisfactorily installed, complete and in place.
- B. A Fire Hydrant Assembly includes the fire hydrant, two guard posts, the mainline tee and associated fittings, thrust block, 8-inch HDPE leg from the main to the gate valve (including 8x6 reducer at the gate valve), 6-inch gate valve, valve box, joint restraints, tracer wire, warning tape, all 6-inch ductile iron from the gate valve to the hydrant assembly, and any other required fittings.
- C. The WORK to install an 18-lb zinc anode will be measured for payment under its respective Pay Item. The 2-Inch Minus Shot Rock w/Base Course and Asphalt Concrete Pavement will be measured for payment under their respective Pay Items.
- D. Salvage of existing fire hydrant will be considered incidental to other WORK under the Contract.
- E. Payment for Fire Hydrant Assembly with Guard Posts will be made at the Unit Price named in the Bid Schedule under Pay Item No. 2603.1, which payment will constitute full compensation for all WORK described in Section 02603 – Fire Hydrants, as shown on the Drawings and as directed by the ENGINEER.

### 2.30 LOCATE WATER SERVICES (Pay Item No.2605.1) PRICE BASED ON LUMP SUM PAY UNIT

- A. Measurement for payment for Locate Water Services will be based upon the completion of the entire WORK as a Lump Sum Pay Unit, complete all in accordance with the requirements of the Contract Documents.
- B. The WORK under this Item Pay includes all excavation and backfill and other WORK necessary to determine the location of all existing water service valve boxes and water services. Some existing water service boxes have not been field located. Service locations should be field verified by the Contractor.
- C. Payment for Locate Water Services will be made at the amount named in the Bid Schedule under Pay Item No. 2605.1, which payment will constitute full

## SPECIAL PROVISIONS

compensation for all WORK described in Section 02605 – Water Services, as shown on the Drawings and as directed by the ENGINEER.

2.31 WATER SERVICE, 1-INCH POLYETHYLENE (Pay Item No. 2605.2) PRICE BASED ON QUANTITY, EACH

- A. Measurement for payment of Water Service, 1-Inch Polyethylene will be based on the actual number of water services satisfactorily installed, complete and in place.
- B. WORK compensated under this Pay Item includes the tee or required fitting at the mainline water pipe, thrust block, 1-inch polyethylene leg from the main tee to connection with existing water pipe or service, joint restraints, tracer wires, warning tapes, curb stop, valve box, and any other pipe and fittings to connect to the existing water service as shown on the Drawings and as directed by the ENGINEER.
- C. Trench excavation, backfill, chlorination and pressure testing, shall be considered incidental to this Pay Item.
- D. Payment for Water Service, 1-Inch Polyethylene will be made at the Unit Price named in the Bid Schedule under Pay Item No. 2605.2, which payment will constitute all WORK described in Section 02605 – Water Services, as shown on the Drawings and as directed by the ENGINEER.

2.32 WATER SERVICE, 2-INCH POLYETHYLENE (Pay Item No. 2605.3) PRICE BASED ON QUANTITY, EACH

- A. Measurement for payment of Water Service, 2-Inch Polyethylene will be based on the actual number of water services satisfactorily installed, complete and in place.
- B. WORK compensated under this Pay Item includes the tee or required fitting at the mainline water pipe, thrust block, 2-inch Polyethylene leg from the main tee to connection with existing water pipe or service, joint restraints, tracer wires, warning tapes, curb stop, valve box, and any other pipe and fittings to connect to the existing water service as shown on the Drawings and as directed by the ENGINEER.
- C. Trench excavation, backfill, chlorination and pressure testing, shall be considered incidental to this Pay Item.
- D. Payment for Water Service, 2-Inch Polyethylene will be made at the Unit Price named in the Bid Schedule under Pay Item No. 2605.3, which payment will constitute all WORK described in Section 02605 – Water Services, as shown on the Drawings and as directed by the ENGINEER.

2.33 PIPE INSULATION (Pay Item No. 2607.1) PRICE BASED ON QUANTITY, BOARDS

- A. Measurement for payment of Pipe Insulation will be the actual number of 2" x 2' x 8' boards installed.
- B. Payment for Pipe Insulation will be made at the Unit Price named in the Bid Schedule under Pay Item No. 2607.1, which payment will constitute full

## **SPECIAL PROVISIONS**

compensation for all WORK described in Section 02607 - Pipe Insulation, as shown on the Drawings and as directed by the ENGINEER.

### 2.34 CONSTRUCTION SURVEYING (Pay Item No. 2702.1) PRICE BASED ON LUMP SUM PAY UNIT

- A. Measurement for payment of Construction Surveying will be based upon the completion of the entire WORK as a Lump Sum Pay Unit, complete, all in accordance with the requirements of the Contract Documents.
- B. The WORK required to remove and reset all survey monuments and other survey markers disturbed by construction activities will be considered incidental to the WORK.
- C. Payment for Construction Surveying will be made at the Unit Price named in the Bid Schedule under Pay Item No. 2702.1, which payment will constitute full compensation for all WORK described in Section 02702 - Construction Surveying, as shown on the Drawings and as directed by the ENGINEER.

### 2.35 TOPSOIL (Pay Item No. 2709.1) PRICE BASED ON QUANTITY, CUBIC YARD

- A. Topsoil will be measured for payment by the cubic yard on the basis of truck measure for all WORK performed in the contract under Section 02709 - Topsoil, completed and accepted.
- B. Topsoil found to be in excess of 3-inches thick, in place and to final grade, will be deducted from the quantity measured by truck measure, based on depths measured at randomly selected locations. Deductions will be computed on the basis of the average end area method.
- C. This is a contingency item. Placement of Topsoil shall be approved and directed by the Engineer.
- D. Payment for Topsoil will be made at the Unit Price named in the Bid Schedule under Pay Item No. 2709.1, which payment will constitute full compensation for all WORK described in Section 02709 - Topsoil, as shown on the Drawings and as directed by the ENGINEER.

### 2.36 TOPSOIL FINISH GRADING (Pay Item No. 2709.2) PRICE BASED ON QUANTITY, MAN-HOUR

- A. Topsoil Finish Grading will be measured per man-hour for each man-hour, or part thereof, that the labor personnel is actually at the Project Site working as directed by the ENGINEER. No measurement for payment will be made for any man-hours not actually working on the finish grading of the topsoil as directed, including travel time, materials and tools expediting, or supervisory personnel.
- B. No measurement for Topsoil Finish Grading will be made until the topsoil has been graded to a uniform, well-drained appearance and approved by the ENGINEER.

## **SPECIAL PROVISIONS**

- C. This is a contingency item to be completed with placement of Topsoil as approved and directed by the Engineer.
  - D. Payment for Topsoil Finish Grading will be made at the Unit Price named in the Bid Schedule under Pay Item No. 2709.2, which payment will constitute full compensation for all WORK described in Section 02709 – Topsoil, as shown on the Drawings and as directed by the ENGINEER.
- 2.37 SEEDING, HYDRAULIC METHOD, TYPE III (Pay Item No. 2710.1) PRICE BASED ON QUANTITY, SLURRY UNIT
- A. Seeding by the hydraulic method will be measured for payment by the number of slurry units (to the nearest 1/10 unit) of mixture actually applied to the designated area, as directed by the ENGINEER.
  - B. Payment for Seeding, Hydraulic Method, Type III will be made at the Unit Price named in the Bid Schedule under Pay Item No. 2710.1, which payment will constitute full compensation for all WORK described in Section 02710 - Seeding, as shown on the Drawings and as directed by the ENGINEER.
- 2.38 REMOVE AND DISPOSE OF STORM AND SANITARY SEWER PIPE (Pay Item No. 2716.1) PRICE BASED ON LUMP SUM PAY UNIT
- A. Measurement for payment for Remove and Dispose of Storm and Sanitary Sewer Pipe will be based upon the completion of the entire WORK as a Lump Sum Pay Unit, complete, all in accordance with the requirements of the Contract Documents.
  - B. Filling of pipes to be abandoned with concrete slurry where pipe removal is not practical shall be considered incidental to this Pay Item.
  - C. Installation of grout plug for storm drain inlet within catch basin structure of #3004 will be considered incidental to this Pay Item.
  - D. Payment for Remove and Dispose of Storm and Sanitary Sewer Pipe will be made at the Unit Price named in the Bid Schedule under Pay Item No. 2716.1, which payment will constitute full compensation for all WORK described in Section 02716 – Storm and Sanitary Sewer Pipe Removal and Water Pipe Slurry, as shown on the Drawings and as directed by the ENGINEER.
- 2.39 FILL WATER PIPE WITH SLURRY (Pay Item No. 2716.2) PRICE BASED ON LUMP SUM PAY UNIT
- A. Measurement for payment for Fill Water Pipe with Slurry will be based upon the completion of the entire WORK as a Lump Sum Pay Unit, complete, all in accordance with the requirements of the Contract Documents.
  - B. The WORK under this pay item includes removal of existing water pipe, existing water service pipe, water service curb stops, valve boxes, fire hydrant valves, fire hydrant pipe, fire hydrant bollards, thrust blocks, pipe fittings, and other related features as shown in the Drawings or directed by the ENGINEER.

## **SPECIAL PROVISIONS**

- C. This WORK also includes removing sections of water pipe or adding pipe and making pipe connections to allow the slurry to be placed in the existing water pipe.
  - D. Payment for Fill Existing Water Pipe with Slurry will be made at the amount named in the Bid Schedule under Pay Item No. 2716.2, which payment will constitute full compensation for all WORK described in Section 02716 –Storm and Sanitary Sewer Pipe Removal and Water Pipe Slurry, as shown on the Drawings and as directed by the ENGINEER.
- 2.40 REMOVE AND DISPOSE OF STORM AND SANITARY SEWER STRUCTURES (Pay Item No. 2717.1) PRICE BASED ON LUMP SUM PAY UNIT
- A. Measurement for payment for Remove and Dispose of Storm and Sanitary Sewer Structures will be based upon the completion of the entire WORK as a Lump Sum Pay Unit, complete, all in accordance with the requirements of the Contract Documents.
  - B. Payment for Remove and Dispose of Storm and Sanitary Sewer Structures will be made at the Unit Price named in the Bid Schedule under Pay Item No. 2717.1, which payment will constitute full compensation for all WORK described in Section 02717 –Storm and Sanitary Structure Removal, as shown on the Drawings, and as directed by the ENGINEER.
- 2.41 RECONSTRUCT MAILBOX (Pay Item No. 2719.1) PRICE BASED ON QUANTITY, EACH
- A. Measurement for payment for Reconstruct Mailbox will be the actual number of mailboxes satisfactorily removed, reconstructed and relocated, as shown on CBJ Standard Detail 116, as directed by the ENGINEER.
  - B. Mailboxes relocated, but not requiring reconstruction, as determined by the ENGINEER, will not be measured for payment, but will be considered incidental to other WORK under this Section.
  - C. Payment for Reconstruct Mailbox will be made at the Unit Price named in the Bid Schedule under Pay Item No. 2719.1, which payment will constitute full compensation for all WORK described in Section 02719 – Mailboxes, as shown on CBJ Standard Detail 116, and as directed by the ENGINEER.
- 2.42 UTILITY CONDUIT RELOCATION (Pay Item No. 2722.1) PRICE BASED ON QUANTITY, LINEAR FOOT
- A. Measurement for Utility Conduit Relocation will be the actual linear feet of power, telephone or cable television conductors or conduits actually relocated and functional, as described in Section 02722 – Utility Conduit Relocation, and as directed by the ENGINEER.
  - B. Only those power, telephone or cable television conductors or conduits actually found to be in direct conflict with storm sewer pipe, or storm drain structures, or



## SPECIAL PROVISIONS

other graded pipe or structures, and approved by the ENGINEER for relocation, will be measured for payment.

- C. WORK under this Pay Item include all power, cable or telephone conductors or conduits three (3) inches or less in diameter, and not encased within concrete.
- D. Conduits that run along the pipe trench, and are not in direct conflict with the culvert pipe, but require that they must be pulled aside to clear the trenching and pipe installation operations will be considered incidental to other WORK under the Contract.
- E. All WORK necessary to install storm drain pipe, or other pipe beneath an existing utility conduit or conductor, including those that are encased in concrete, which does not vertically conflict with the new pipe, will be considered incidental to other WORK.
- F. Payment for Utility Conduit Relocation will be made at the Unit Price named in the Bid Schedule under Pay Item No. 2722.1, which payment will constitute full compensation for all WORK described in Section 02722 – Utility Conduit Relocation, as shown on the Drawings and as directed by the ENGINEER.

### 2.43 ASPHALT CONCRETE PAVEMENT, TYPE II-A, CLASS B (Pay Item No. 2801.1) PRICE BASED ON QUANTITY, TON

- A. Measurement of Asphalt Concrete Pavement will be measured for payment by the ton.
- B. No measurement will be made for asphalt concrete pavement that exceeds 12% more than the neatline quantity, as determined by the nominal design thickness multiplied by the actual area paved, with a conversion factor of 119 lb per square yard per inch of thickness.
- C. All resealing of joints with existing pavement, including those resealed after the pavement has cooled to ambient temperatures, will not be measured for payment, but will be considered incidental to other WORK under the contract.
- D. WORK under this Pay Item includes all pavement placed within project site including roadway, driveways, pathway, and hydrant pads, as shown on the Drawings
- E. Tack Coat applied to existing joint surfaces and along edge of gutters prior to placement of A.C. pavement, will be considered incidental to other WORK.
- F. Asphalt Concrete Pavement required for reconstructed collars around manholes and water valves, if any, will be considered incidental to other WORK under this Section.
- G. Payment for Asphalt Concrete Pavement, Type II-A, Class B, will be made at the Unit Price named in the Bid Schedule under Pay Item No. 2801.1, which payment will constitute full compensation after quality deductions are, if applicable for all

## **SPECIAL PROVISIONS**

WORK described in Section 02801 - Asphalt Concrete Pavement, as shown on the Drawings and as directed by the ENGINEER.

- 2.44 REMOVE EXISTING ASPHALT SURFACING (Pay Item No. 2806.1) PRICE BASED ON QUANTITY, SQUARE YARDS
  - A. Removing asphalt surfacing, including leveling course, will be measured for payment per square yard, complete, except that no measurement will be made for removing asphaltic surfacing less than one-inch-thick.
  - B. Removal of existing asphalt surfacing will be measured per top square yard, which will include the full thickness of all layers of existing asphalt, including leveling courses and underlying pavement.
  - C. No deduction shall be made to the area measured for payment under this Pay Item for the area within the existing road prism that consists of concrete patches. Removal and disposal of concrete roadway patches shall be considered incidental to this Pay Item.
  - D. Payment for Remove Existing Asphalt Surfacing will be made at the Unit Price named in the Bid Schedule under Pay Item No. 2806.1, which payment will constitute full compensation for all WORK described in Section 02806 - Remove Existing Asphalt Surfacing, as shown on the Drawings and as directed by the ENGINEER.
  
- 3.1 CONCRETE HEADWALL w/TRASHRACK (Pay Item No. 3302.1) PRICE BASED ON QUANTITY, EACH
  - A. Concrete Headwall w/Trashrack will be measured for payment per each, including all earth work, complete in place.
  - B. Payment for Concrete Headwall w/Trashrack will be made at the Unit Price named in the Bid Schedule under Pay Item No. 3302.1, which payment will constitute full compensation for all WORK described in Section 03302 – Concrete Structures, as shown on the Drawings and as directed by the ENGINEER.
  
- 3.2 CONCRETE HEADWALL (Pay Item No. 3302.2) PRICE BASED ON QUANTITY, EACH
  - A. Concrete Headwall will be measured for payment per each, including all earth work, complete in place.
  - B. Payment for Concrete Headwall will be made at the Unit Price named in the Bid Schedule under Pay Item No. 3302.2, which payment will constitute full compensation for all WORK described in Section 03302 – Concrete Structures, as shown on the Drawings and as directed by the ENGINEER.
  
- 3.3 ADA RAMPS AND LANDINGS (Pay Item No. 3303.1) PRICE BASED ON LUMP SUM PAY UNIT

## SPECIAL PROVISIONS

- A. Measurement for payment of ADA Ramps and Landings will be based upon the completion of the entire WORK as a Lump Sum Pay Unit, complete, all in accordance with the requirements of the Contract Documents.
  - B. WORK under this Pay Item will include all concrete and tile required for the landing and flares at ~STA “G” 10+13.65 LT and 10+49.08 LT.
  - C. Repainting of Blueberry Hills crosswalk bar(s) as required will be considered incidental.
  - D. Payment for ADA Ramps and Landings, will be made at the amount named in the Bid Schedule under Pay Item No. 3303.1, which payment will constitute full compensation for all WORK described in Section 03303 – Sidewalk, Curb and Gutter, as shown on the Drawings and as directed by the ENGINEER.
- 3.4 CURB AND GUTTER, TYPE I (Pay Item No. 3303.2) PRICE BASED ON QUANTITY, LINEAR FOOT
- A. Curb and Gutter, Type I, will be measured for payment per linear foot actually installed, complete in place as shown on the Contract Documents. Measurements will be made along the face of the curb and will be continuous across catch basins.
  - B. Payment for Curb and Gutter, Type I, will be made at the Unit Price named in the Bid Schedule under Pay Item No. 3303.2, which payment will constitute full compensation for all work described in Section 03303 - Sidewalk, Curb and Gutter, as shown on the Drawings, and as directed by the ENGINEER.
- 3.5 VALLEY GUTTER, TYPE III (Pay Item No. 3303.3) PRICE BASED ON QUANTITY, LINEAR FOOT
- A. Valley Gutter, Type III, will be measured for payment per linear foot actually installed, complete in place as shown on the Contract Documents. Measurements will be made along the flowline of the gutter pan and will be continuous across catch basins.
  - B. Payment for Valley Gutter, Type III, will be made at the Unit Price named in the Bid Schedule under Pay Item No. 3303.3, which payment will constitute full compensation for all work described in Section 03303 - Sidewalk, Curb and Gutter, as shown on the Drawings, and as directed by the ENGINEER.
- 3.6 REMOVAL OF CURB AND GUTTER (Pay Item No. 3304.1) PRICE BASED ON QUANTITY, LINEAR FOOT
- A. Removal of Curb and Gutter will be measured by the actual linear foot of concrete curb and gutter originally in place, removed and disposed of in accordance with the Contract Documents.
  - B. Payment for Removal of Curb and Gutter will be made at the Unit Price named in the Bid Schedule under Pay Item No. 3304.1, which payment will constitute full compensation for all WORK described in Section 03304 – Remove Existing Sidewalk, Concrete Slab or Curb and Gutter, as shown on the Drawings and as directed by the ENGINEER.

## SPECIAL PROVISIONS

3.7 REMOVE AND RESET CONCRETE PAVERS (Pay Item No. 3305.1) PRICE BASED ON LUMP SUM PAY UNIT

- A. Measurement of Remove and Reset Concrete Pavers will be based on the completion of the entire WORK as a Lump Sum Pay Unit, complete, all in accordance with the requirements of the Contract Documents.
- B. WORK will include removing and resetting pavers at the driveway of house #3000 Goodwin Road.
- C. This Pay Item includes the WORK to remove, clean and reset existing precast pavers, and furnish and install, bedding and joint sand, paving and joint sealer.
- D. Payment for Remove and Reset Concrete Pavers will be made at the Unit Price named in the Bid Schedule under Pay Item No. 3305.1, which payment will constitute full compensation for all WORK described in Section 03305 – Concrete Pavers, as shown on the Drawings and as directed by the ENGINEER.

**PART 2 – PRODUCTS (Not Used)**

**PART 3 – EXECUTION (Not Used)**

### END OF SECTION

**SECTION 01550 – SITE ACCESS AND STORAGE, PART 1 – GENERAL, *add* the following Article:**

1.6 RESIDENT OWNER WORK

- A. Property owners within the Project area may have work done along their property during the Project construction period. This work may proceed following removal of the existing sidewalk and excavation work in the vicinity of their property by the CONTRACTOR.
- B. The CONTRACTOR shall provide each property owner a schedule for the installation of new curb and gutter and sidewalk along their property a minimum of seven (7) days in advance of concrete formwork.

**SECTION 01570 – EROSION AND SEDIMENT CONTROL, PART 1 – GENERAL, Article 1.1, THE REQUIREMENT, *add the following paragraph:***

- D. The area of disturbance for this project is less than 1 acre.

**SECTION 02201 - CLEARING AND GRUBBING, PART 3 - EXECUTION, Article 3.3, HAND CLEARING, *add the following paragraph:***

- B. Hand Clearing shall be done via pruning shears or hedge trimmer. Chain saws shall not be used on branches smaller than 2" in diameter.

**SECTION 02201 - CLEARING AND GRUBBING, PART 3 - EXECUTION, *add the following Article:***

## SPECIAL PROVISIONS

### 3.6 REMOVE AND SET ASIDE PLANTINGS

- A. The CONTRACTOR shall notify each property owner whose plantings or other landscape items are to be disturbed a minimum of seven (7) days in advance of disturbing these plantings or other landscape items. This includes all items fronting on the property from the edge of the paved street towards the residence.
- B. If the property owner requests to have the plantings or other landscaping items disposed of, the CONTRACTOR shall remove and dispose of these items at no additional cost to the OWNER.
- C. If the property owner requests to remove and set aside the plantings or other landscaping items themselves, the CONTRACTOR shall provide a minimum of seven (7) days to the property owner for this WORK.

**SECTION 02202 – EXCAVATION AND EMBANKMENT, PART 2 – PRODUCTS, Article 2.7, *replace Paragraph A with the following paragraph:***

- A. Shot Rock Borrow shall consist of 6-inch minus shot rock and shall contain no mulch, frozen material, roots, sod or other deleterious matter. The shot rock borrow shall be evenly graded, with at least 10% by weight retained on the 4-inch screen. Shot rock will be obtained from quarry rock, unless otherwise approved by the ENGINEER.

**SECTION 02202 – EXCAVATION AND EMBANKMENT, PART 2 – PRODUCTS, *add the following Article:***

### 2.9 USABLE MATERIAL FROM EXCAVATION

- A. Usable material from excavation shall meet the requirements for Embankment.

**SECTION 02202 – EXCAVATION AND EMBANKMENT, PART 3 – EXECUTION, Article 3.4, EMBANKMENT CONSTRUCTED FROM ROCK FRAGMENTS, *add the following paragraph:***

- F. The shot rock borrow shall be brought to its full depth and capped with a 3-inch minimum thickness of 2-inch minus shot rock within a maximum of ten (10) days following the initial placement of the shot rock borrow into the subcut area. The 2-inch minus shot rock shall be placed to a minimum width of 10-feet and shall be placed to within 10-feet of the ends of the shot rock borrow segment.

**SECTION 02203 – TRENCHING, PART 2 - MATERIALS, Article 2.2, BEDDING, *add the following paragraphs:***

- D. Pea gravel, or similar product, shall not be used for bedding.
- E. Class A bedding material shall be used for all water and sanitary sewer force main pipe. Class B bedding material shall be used for all storm sewer pipe.

## SPECIAL PROVISIONS

**SECTION 02204 – BASE COURSE, PART 2 – PRODUCTS** Article 2.1, MATERIALS, *add the following paragraphs:*

- E. Related Section – Section 02202 – EXCAVATION AND EMBANKMENT, Article 2.8, 2-INCH MINUS SHOT ROCK
- F. Base course for this project shall have a maximum Nordic Abrasion Value of 18, as determined by ATM 312, and shall meet the gradation requirements for grading D-1.

**SECTION 02204 – BASE COURSE, PART 3 – EXECUTION**, Article 3.1, GENERAL, *replace Paragraph I with the following paragraph:*

- I. The surface of the base course, when using a taut string line or straight edge of adequate length, spanning between two known grade control points (blue top hubs, lip of gutter, edge existing asphalt etc.) shall not show any deviation in excess of 3/8 inch. This shall be checked perpendicular and longitudinally to the grade control points and be documented by the INSPECTOR. The finish surface shall not vary more than 1/2 inch from established grade. Additionally, the algebraic average of all deviations from established grade of the finish base course surface elevations taken at 50-foot intervals shall be less than 0.02 foot.

**SECTION 02402 – SANITARY SEWER MANHOLES AND CLEANOUTS, PART 3 - EXECUTION**, Article 3.1 CONSTRUCTION, Paragraph M, *delete* sub-paragraph 4 and *replace* with the following:

- 4. Rubber grade ring adjustment risers shall be bonded to adjacent surfaces by laying at least 3 beads, a minimum of 5/16” thick of Liquid Nails-Polyurethane Construction Adhesive on each side of the rubber risers or the top surface of the concrete course. Two of the adhesive beads shall be within 1” of the edges of the rubber grade ring adjustment riser, the third shall be equidistant between the two outer beads. The beads shall be continuous around the rubber grade ring adjustment riser.

**SECTION 02402 – SANITARY SEWER MANHOLES AND CLEANOUTS, PART 3 - EXECUTION**, Article 3.1 CONSTRUCTION, *add the following paragraphs:*

- P. Adjust sanitary manhole to grade shall include new concrete adjusting rings, recycled rubber adjusting rings, existing frame and cover adjusted to grade.
- Q. Reconstruction Sanitary Manhole shall include new concrete adjusting rings, full barrel risers, recycled rubber adjusting rings, adjustment to grade, and waterproofing the entire manhole.

*Add the following Section:*

### SECTION 02404 – WATERPROOF PUMP STATION

#### PART 1 - GENERAL

## SPECIAL PROVISIONS

### 1.1 DESCRIPTION

- A. The WORK under this Section includes all labor, materials, tools, and equipment necessary for water proofing pump station.

### PART 2 – PRODUCTS

#### 2.1 MATERIALS

- A. Waterproofing shall be a Miradri system as manufactured by Mirafi, Inc. including Miradri P-804 primer, Miradria 861 Membrane, and Miradri M-800 mastic, or approved equal that includes a membrane and adhesive system for positive water exclusion.

### PART 3 – EXECUTION

#### 3.1 CONSTRUCTION

- A. The exterior waterproofing system shall be installed as recommended by the system manufacturer and as shown on the Drawings.

### END OF SECTION

**SECTION 02501 – STORM SEWER PIPE, PART 2 – PRODUCTS, Article 2.6, CORRUGATED POLYETHYLENE PIPE, *delete paragraphs B and C and replace with the following:***

- B. Pipe shall be joined with “ADS, Inc. N-12” (bell-and-spigot) water-tight (WTIB), or approved equal, meeting the requirements of AASHTO M252 or AASHTO M 294 or ASTM F2306. The pipe joining system shall be a water-tight integral bell & gasketed spigot meeting the requirements of ASTM D3212 or equivalent standard.
- C. The bell-and-spigot joint shall be water-tight and incorporate a gasket meeting the requirements of ASTM F477 or equivalent standard. Gaskets shall be installed in the bell, or on the pipe, by the pipe manufacturer and covered with a removable wrap to ensure the gasket is free from debris at the time of installation. A joint lubricant shall be used on the gasket and bell during assembly.

**SECTION 02501 – STORM SEWER PIPE, PART 2 – PRODUCTS, *add the following* Articles:**

#### 2.10 6-INCH UNDERDRAIN

- A. Pipe shall be perforated, smooth interior pipe and shall meet the requirements of Article 2.7 of this Section.
- B. Drainage rock shall be 2-inch minus shot rock and shall meet the requirements of Section 02202 – Excavation and Embankment, Article 2.8, 2-Inch Minus Shot Rock.
- C. Filter cloth shall be Type A and shall meet the requirements of Section 02714 – Filter Cloth.

## SPECIAL PROVISIONS

### 2.11 SLIP LINE PIPE CULVERT

- A. Pipe shall meet the requirements of Article 2.5, PVC Pipe Conduit, of this Section.

**SECTION 02501 – STORM SEWER PIPE, PART 3 – EXECUTION, *add the following* Articles:**

### 3.2 SLIP LINE PIPE CULVERT

- A. Prior to commencing slip lining operations, the CONTRACTOR shall submit a detailed plan of operation to the ENGINEER for approval. Submit the plan at least seven days prior to the date approval in desired.
- B. Prior to the installation of the slip line pipe, CONTRACTOR shall thoroughly clean the existing storm drain pipe designated to receive the slip line pipe. Remove all debris, solids, roots, deposits, and other matter which would preclude the installation of the slip line pipe into the host pipe.
- C. Sections of the slip line pipe shall be field connected in the insertion pit and then inserted into the host pipe. Take precautions to prevent ragged edges of the host pipe from scoring the slip line as it is being inserted.
- D. Upon completion of the slip lining operation, seal the annular space at upstream end of host pipe with grout.

**SECTION 02601 – WATER PIPE, PART 2 – PRODUCTS, Article 2.3, FITTINGS, *delete paragraph J and replace with the following*:**

- J. Electrofusion couplers are discouraged and may only be allowed with prior, written approval of the Engineer. Not having a fusion machine capable of being placed in the excavation to accomplish butt fusion is not an acceptable reason for use of an electrofusion coupler.

**SECTION 02601 – WATER PIPE, PART 3 – EXECUTION, Article 3.5, HYDROSTATIC TESTING, *add the following paragraphs*:**

- K. At no time shall the CONTRACTOR pressure test against existing valves, plugs, caps, fire hydrants or curb stops. At no time shall the CONTRACTOR use disinfection water or untreated water to pressure test against any valve or curb stop that is connected to a public water system.
- L. Pressure testing shall be completed for the entire length of new water pipe and services to the limits where new water pipes and services connect to existing water pipes and services, including pressure testing to the limits of connection to existing fire hydrant legs. The CONTRACTOR is responsible for providing all temporary or permanent joint restraints, thrust blocks, fittings, caps, plugs, curb stops and valves necessary for completion of pressure testing activities in accordance with SECTION 02601 and to the satisfaction of the ENGINEER.

**SECTION 02601 – WATER PIPE, PART 3 – EXECUTION, Article 3.8, CONNECTIONS TO EXISTING PIPES, *add the following paragraph*:**



## SPECIAL PROVISIONS

- C. All flushing, pressure testing, and disinfection of new water pipes shall be completed in accordance with SECTION 02601 and accepted by the ENGINEER prior to making final or permanent connections to existing water pipes and services. At no time during flushing, pressure testing or disinfection activities shall there be a temporary or permanent cross-connection between new water pipe and existing water pipe or services, unless otherwise approved by the ENGINEER or a backflow prevention assembly meeting ANSI/AWWA Standards C510-97 or C511-97 is used to ensure no backflow into the existing and unprotected public water system occurs.

**SECTION 02605 – WATER SERVICES, PART 3 – EXECUTION, Article 3.1, CONSTRUCTION, add the following paragraph:**

- I. The location of existing water service lines shown on the drawings are based off of limited as-built information, field locates, and resident communication and are not considered reliable indications of actual locations. These services may not run in a straight line to the water main as shown in the Drawings. The CONTRACTOR shall verify the location, material size, and depth of each water service pipe.

**SECTION 02702 – CONSTRUCTION SURVEYING, PART 3 – EXECUTION, Article 3.1, CONSTRUCTION, *add the following paragraphs:***

- M. A closed level loop is required through TBMs listed in the Drawings. No side shots will be permitted. A copy of the surveyor's notes shall be provided to the ENGINEER. No payment will be made for Pay Item No. 2702.1 until the Engineer has received a copy of these surveyor's notes.
- N. Global Position System (GPS) survey methods shall not be used for grading control unless approved in writing by the ENGINEER.

**SECTION 02709 – TOPSOIL, PART 2, - PRODUCTS, Article 2.1, MATERIALS, *revise the first sentence of paragraph C to read:***

- C. Topsoil shall contain not less than 8% or more than 20% organic matter by weight, as determined by loss-on-ignition of oven-dried samples in accordance with ASTM T-6.

**SECTION 02709 – TOPSOIL, PART 3, - EXECUTION, Article 3.1, CONSTRUCTION, *revise paragraph A to read:***

- A. All areas beyond the roadway shoulder and driveway edges that require regrading or are otherwise disturbed during construction, shall be graded to neat, uniform, well-drained grade lines and appearance, as determined by the ENGINEER. These areas shall be hydroseeded, unless otherwise shown on the Drawings, or directed by the ENGINEER.

**SECTION 02716 – REMOVAL AND DISPOSAL OF CULVERT PIPE, *delete in its entirety and replace with the following Section:***

## **SPECIAL PROVISIONS**

### **SECTION 02716 – STORM AND SANITARY SEWER PIPE REMOVAL AND WATER PIPE SLURRY**

#### **PART 1 - GENERAL**

##### **1.1 DESCRIPTION**

- A. The WORK under this Section includes providing all labor, tools and equipment necessary for removal and disposal of existing storm drainage pipe, sanitary sewer pipe, and the existing water system or filling the existing water pipes with Cement Slurry within the Project limits designated for removal.

#### **PART 2 – PRODUCTS (Not Used)**

##### **2.1 MATERIALS**

- A. Cement Slurry used to fill conveyance structures prior to abandonment shall consist of a flowable mixture of cement, water, sand, and additives that, when cured for three (3) days, will have a minimum compressive strength of 150 pounds per square inch (psi). A Cement Slurry design shall be submitted by the CONTRACTOR for approval by the ENGINEER prior to use.

#### **PART 3 – EXECUTION**

##### **3.1 GENERAL**

- A. All storm drainage pipe, 6-inches or larger, shown on the Drawings for removal shall be removed and backfilled with suitable material to match the adjacent ground surface. Usable material from excavation shall be used as backfill. Disposal of the pipe shall be in accordance with these Specifications.
- B. Existing water main pipe, services, water valves, valve boxes, fittings, thrust blocks, and other water system components shall be removed in their entirety and disposed of in accordance with the Contract Documents, as shown on the Drawings and as directed by the ENGINEER.
- C. All materials removed during performance of the WORK described herein shall become the property and responsibility of the CONTRACTOR.
- D. Voids shall be backfilled with suitable material to match the adjacent ground surface or bottom of subcut, and placement of material used for backfill shall not exceed 2-ft lifts. Usable material from excavation may be used as backfill as approved by the ENGINEER, and all backfill placed shall be compacted to the satisfaction of the ENGINEER.
- E. Where shown on the Drawings, existing water pipes shall be abandoned in place by filling with Cement Slurry to a minimum of eighty percent (80%) capacity of the calculated volume based on the length and inside diameter of the conveyance structure being abandoned. If necessary, all pumps, vent tubes, and WORK to open or remove additional sections of the existing conveyance structure for meeting the

## **SPECIAL PROVISIONS**

minimum volume filled requirement shall be the responsibility of the CONTRACTOR.

### **END OF SECTION**

*Add the following Section:*

#### **SECTION 02722 – UTILITY CONDUIT RELOCATION**

##### **PART 1 - GENERAL**

###### **1.1 DESCRIPTION**

- A. The WORK under this Section includes subcontracting or otherwise arranging with AEL&P, ACS Telephone, or GCI Cable Network for any work with the power, telephone and television services, respectively, for the WORK shown on the Drawings or described in this Section.

##### **PART 2 – PRODUCTS**

###### **2.1 MATERIALS**

- A. Materials shall be as specified by the owner of the private utility service company.
- B. Materials shall conform to the requirements of the National Electrical Code.

##### **PART 3 – EXECUTION**

###### **3.1 CONSTRUCTION**

- B. Construction shall be in accordance with the agreement arranged by the CONTRACTOR with the owner of the utility service being relocated, except that the Drawings and Specifications shall take precedence in the event of a conflict.
- C. All WORK with the electrical utilities shall conform to the requirements and standards established by the private utility companies, and shall meet all applicable codes and regulations.
- C. The WORK under this Section does not include excavating, backfilling, or any other work under, around, or along electrical utilities that are not in direct conflict with other work.

###### **3.2 ELECTRICAL CONDUCTOR RELOCATION**

- A. The WORK under this Item include only those electrical conduit or conductor relocations required due to a direct conflict with new piping or structures, that are 3-inches or less in diameter, and not encased in concrete.

### **END OF SECTION**

**SPECIAL PROVISIONS**

**SECTION 02801 – ASPHALT CONCRETE PAVEMENT, PART 1 - GENERAL, Article 1.1, DESCRIPTION, *revise paragraph B as follows:***

- B. Asphaltic concrete mix for this Project shall be Type IIA, Class B.

**SECTION 02801 – ASPHALT CONCRETE PAVEMENT, PART 1 – GENERAL, Article 1.1, DESCRIPTION, *revise* TABLE 02801-1, ASPHALTIC CONCRETE MIX REQUIREMENTS, *as follows:***

<u>Design Parameters</u>	<u>Class A</u>	<u>Class B</u>
Voids in total mix, percent	2.5 – 4.0	2.5 – 4.0%
Percent oil content	5.8 – 6.8	5.8 – 6.8%

**SECTION 02801 – ASPHALT CONCRETE PAVEMENT, PART 2 – PRODUCTS, Article 2.1, COMPOSITION OF ASPHALT CONCRETE MIXTURES – JOB MIX DESIGN, paragraph C., *delete subparagraph 6 and replace with the following:***

- 6. The mix design shall be 50 blow Marshall Method.

**SECTION 02801 – ASPHALT CONCRETE PAVEMENT, PART 2 - PRODUCTS, Article 2.3, ASPHALT MATERIALS, *revise paragraph B as follows:***

- B. Asphalt cement shall be designated PG 58-28 Plus.

**SECTION 02801 – ASPHALT CONCRETE PAVEMENT, PART 2 - PRODUCTS, **add** the following section:**

**2.6 RECLAIMED ASPHALT PAVEMENT**

- A. Reclaimed Asphalt Pavement (RAP) may be used in the asphalt mix up to 20% of the total mix.
- B. RAP will be available at no cost from the CBJ Lemon Creek Stockpile. The contractor will notify Michael Eich, CBJ Pits and Quarries Manager, 586-0874, of quantity needed, to coordinate access and for Lemon Creek Gravel Pit permit compliance requirements, prior to taking any RAP. The Contractor shall weigh each load at the CBJ scales and record on a CBJ scale ticket. The CBJ makes no guarantees of the quantity or quality of the RAP.
- C. The Contractor shall provide a mix design showing the inclusion of the specified percentage of RAP according to the mix design requirements in this section.
- D. Use of RAP in the Contractor’s asphalt mix does not nullify any of the other specification requirements or associated asphalt quality deductions.

**SECTION 02801 – ASPHALT CONCRETE PAVEMENT, PART 3 - EXECUTION, Article 3.2, EQUIPMENT, Paragraph C, *delete item 2 and replace with the following:***

- 2. Each truck shall have a watertight canvas cover of such size as to extend at least one foot over the sides and end of the truck bed and be adequately secured to protect the asphalt concrete mixture. The use of canvas covers will be required at all times.

## SPECIAL PROVISIONS

3. The Contractor shall make the trucks to be used for hauling the asphalt concrete mixture available for inspection by the Engineer prior to paving day and shall be identified in the Paving Plan. Trucks that do not meet the requirements of this section may be rejected by the Engineer and not allowed on the project unless the deficiencies are remedied and approved by the Engineer in advance of hauling asphalt. Use of trucks not approved for delivery by the Engineer may result in the rejection of the asphalt concrete mixture within the unapproved truck.

**SECTION 02801 – ASPHALT CONCRETE PAVEMENT, PART 3 - EXECUTION, Article 3.2, EQUIPMENT, *add the following paragraph:***

- E. Heavy, full size, self-propelled laydown units that will place concentrated loading on curb and gutter sufficient to cause breakage, or other damage to the concrete, will not be permitted.

**SECTION 02801 – ASPHALT CONCRETE PAVEMENT, PART 3 - EXECUTION, Article 3.8, SPREADING AND PLACING, *delete paragraph H and replace with the following:***

- H. Manhole frame and covers and water valve boxes shall be set to final grade in accordance to CBJ Standard Details 205 – MANHOLE HEIGHTS and 407 – MAINLINE VALVE, prior to paving operations. If the cover lugs or frame, whichever is higher, does not meet the required depression range following the finish paving operations, the CONTRACTOR shall construct a transition slab with asphalt pavement overlay, per CBJ Standard 126 – CONCRETE COLLAR or as approved by the Engineer, at no additional cost to the OWNER.

**SECTION 02801 – ASPHALT CONCRETE PAVEMENT, PART 3 - EXECUTION, Article 3.8, SPREADING AND PLACING, *add the following paragraph:***

- K. The Contractor shall hold in a pre-paving conference on site to review and verify the accuracy of the Paving Plan prior to paving day. The paving foreman shall be present to explain each of the operational details included in the paving plan.

**SECTION 02801 -- ASPHALT CONCRETE PAVEMENT, PART 3 – EXECUTION, Article 3.10, JOINTS, *replace* Paragraph C with the following:**

- C. Improperly formed joints resulting in surface irregularities or rock segregation shall be removed, full road width, replaced with new material, and thoroughly compacted. The edge of pavement along the centerline joint shall not be allowed to drop below 200 degrees Fahrenheit prior to the asphalt mix form the adjacent lane being placed against this edge.

**SECTION 02801 -- ASPHALT CONCRETE PAVEMENT, PART 3 – EXECUTION, Article 3.10, JOINTS, *add the following paragraph:***

- J. All joints with existing asphalt pavement shall be resealed with asphalt cement after the new pavement has cooled to ambient temperature.

**SECTION 02801 – ASPHALT CONCRETE PAVEMENT, PART 3 – EXECUTION, Article 3.13, Acceptance Sampling and Testing, *add the following paragraph:***

## SPECIAL PROVISIONS

- K. For each lot of asphalt pavement produced, at least two (2) samples shall be taken by the CONTRACTOR for purposes of acceptance testing by the OWNER. The CONTRACTOR shall split the sample with the OWNER to retain a portion for their use. The sample shall be taken according to proper sampling methods, from the asphalt pavement on the grade.

The deduction amounts will be determined from the OWNER's acceptance testing results. The values will be calculated by averaging the amount of the absolute value of the two tests outside the job mix design tolerance (the difference between the actual test result and the job mix design tolerance range). A test value within the job mix design tolerance will be considered a zero (0) value for averaging the two values. Deduction from the asphalt pavement pay item shall be made at the following amounts:

1. #200 Sieve: the greater of either 1.0% the contract price for asphalt pavement placed within the sampled lot or \$500 per each 0.1% outside the job mix design tolerance, not exceeding 6% maximum, of the percent passing the #200 sieve. The allowable tolerance for this Contract shall be +/-1.0% of the target mix design value and shall not exceed the content limits specified in this Contract. If values fall outside of the allowable tolerance, deductions shall be calculated from the mix design target value.
2. Asphalt Content: the greater of either 1.0% of the contract price for asphalt pavement placed within the sampled lot or \$500 per each 0.1% outside the allowable job mix design asphalt content tolerance. The allowable asphalt content tolerance for this Contract shall be +/- 0.4% of the target job mix design value and not to fall below a value of 5.6%. If values fall outside of the allowable tolerance, deductions shall be calculated from the mix design target value .

The pay deductions for exceeding the job mix design tolerances does not constitute acceptance of a mix that does not meet the specifications. Variations that are excessively large in a lot may be considered for larger deductions or non-payment. Further acceptance testing will be performed to determine if the asphalt pavement specifications have been met. No payment for asphalt pavement will be made for asphalt pavement exceeding job mix design tolerances, or not meeting asphalt pavement specifications, until additional testing determines whether the asphalt pavement meets all other specifications.

For the purposes of this Contract, one lot of asphalt pavement is defined as 500 tons, or a single day's asphalt pavement production of at least 100 tons.

**SECTION 03302 – CONCRETE STRUCTURES, PART 3 – EXECUTION, *add the following Articles:***

### 3.4 CONCRETE HEADWALL WITH HINGED TRASHRACK

- A. The concrete headwall shall conform to CBJ Standard Detail 104A – Culvert Headwall with Hinged Trash Rack, with adjustments to match the site conditions

## SPECIAL PROVISIONS

and grades, as approved by the ENGINEER. No concrete shall be placed until the formwork has been approved by the ENGINEER.

### 3.5 CONCRETE HEADWALL WITHOUT HINGED TRASH RACK

- A. The headwall shall conform to CBJ Standard Detail 104B – Culvert Headwall without Hinged Trash Rack, with modifications shown in the drawings, including but not limited to a 1h:1v face slope with adjustments to match the site conditions and grades, as approved by the ENGINEER. No concrete shall be placed in the until the formwork has been approved by the ENGINEER.

### SECTION 03303 – SIDEWALK, CURB AND GUTTER, PART 2 - PRODUCTS, Article 2.1, MATERIALS, *revise paragraph B. to read:*

- B. Synthetic fibers shall be used for reinforcement with curb and gutter, concrete hydrant pads, and concrete sidewalk replacements, except a 6-foot length of No. 4 reinforcing bar shall be centered across catch basins centered in the curb. Except as described above, reinforcing steel or wire mesh shall not be used unless approved by the ENGINEER. Curbs, gutters and sidewalk shall utilize a fibrillated product, Fibermesh 300, or approved equal. Application rates shall be at least 1.5 pounds per cubic yard of concrete. Fibermesh shall be as manufactured by “SI Concrete Systems,” or approved equal.

### SECTION 03303 – SIDEWALK, CURB AND GUTTER, PART 2 - PRODUCTS, Article 2.1, MATERIALS, *add the following paragraph:*

- C. Detectable tiles shall be cast iron detectable warning plates with truncated dome pattern, a slip resistant surface, and with handle or flange on bottom or approved equal. Detectable warning plates shall be coated with yellow polymer-soaked finish and manufactured according to the 2006 U.S. DOT ADA Standards for Transportation Facilities.

### SECTION 03303 – SIDEWALK, CURB AND GUTTER, PART 3 – EXECUTION, Article 3.1, METHODS OF CONSTRUCTION, *add the following paragraphs:*

- J. All forms for segments between PC’s and PT’s with a radius less than 100' shall be arced to match the required curvature. No straight forms will be permitted for use within any curved segments with a radius of less than 100'. Straight forms used for any arced segment with a radius of more than 100' shall not exceed 10' in length.
- K. The CONTRACTOR shall cure and protect all newly placed concrete as required to prevent cracking or disfigurement during the curing period. Damaged concrete shall be repaired or replaced to the ENGINEER’s satisfaction at no additional cost.
- L. All concrete sidewalk, curb ramps, and pedestrian access ramps shall meet the current requirements of the Americans with Disabilities Act (ADA) regulations for new construction. WORK that is found not to be in compliance with ADA regulations shall be immediately remedied by the CONTRACTOR, included replacement of non-conforming ADA facilities at no additional cost to the OWNER, unless ADA standards cannot be met due to site constraints

## **SPECIAL PROVISIONS**

and the WORK has been constructed in accordance with the contract documents.

- M. Construct detectable warnings according to the details and the locations shown on the Drawings. Install detectable warning plates by embedding plate flanges into cast in place concrete construction so there are no vertical changes in grade exceeding 0.25 inch or horizontal gaps exceeding 0.5 inch. Align pattern on a square grid in the predominant direction of travel.

*Add the following Section:*

### **SECTION 03305 - CONCRETE PAVERS**

#### **PART 1 – GENERAL**

##### **1.1 RELATED DOCUMENTS**

- A. Drawings and general provisions of the contract, including General and Supplementary Conditions and Division 1 specification sections, apply to this Section.

##### **1.2 SUMMARY**

- A. This Section includes the following pavers and related materials:
  - 1. Concrete Pavers
  - 2. Bedding and Joint Sand
  - 3. Paving and joint sealer
- B. Related Sections include the following:
  - 1. CBJ Standard Specifications
  - 2. Section 03300 – Cast In Place Concrete, for installation concrete curbs and slabs.

##### **1.3 REFERENCES**

- A. The following references pertain to this section.
  - 1. American Society of Testing and Materials (ASTM) (latest edition):
  - 2. C 33 Specification for Concrete Aggregates.
  - 3. C 136 Method for Sieve Analysis for Fine and Coarse Aggregate.
  - 4. C 140 Sampling and Testing Concrete Masonry Units.
  - 5. C144 Specification for Natural and Manufactured Sands.
  - 6. C 936 Specification for Solid Interlocking Concrete Paving Units.
  - 7. C 979 Specification for Pigments for Integrally Colored Concrete.
  - 8. D 698 Test Methods for Moisture Density Relations of Soil and Soil Aggregate Mixtures Using a 5.5 lb Rammer and 12 in. drop.
  - 9. D 1557 Test Methods for Moisture Density Relations of Soil and Soil Aggregate Mixtures Using a 10-lb Rammer and 18 in. drop.



## **SPECIAL PROVISIONS**

- 10. D 2940 Graded Aggregate Material for Bases or Subbases for Highways or Airports.

### 1.4 QUALITY ASSURANCE

- A. Installation shall be by a contractor and crew with experience on at least one prior project placing interlocking concrete pavers.
- B. The CONTRACTOR shall conform to all local, state/provincial licensing and bonding requirements.

### 1.5 SUBMITTALS

- A. Shop or product Drawings and product data shall be submitted for bedding and joint sand, and paving and joint sealer.
- B. Sieve analyses for grading of bedding and joint sand shall be submitted.

### 1.6 DELIVERY, STORAGE, AND HANDLING

- A. Bedding and joint sand shall be covered with a secure waterproof covering to prevent exposure to rainfall or removal by wind.

### 1.8 ENVIRONMENTAL CONDITIONS

- A. Sand or pavers shall not be installed during heavy rain or snowfall.
- B. Sand and pavers shall not be installed over frozen base materials.
- C. Frozen bed sand and joint sand shall not be installed.

## **PART 2 - PRODUCTS**

### 2.1 CONCRETE PAVERS

- A. Existing pavers shall be removed and reused.

### 2.2 BEDDING SAND

- A. Provide bedding sand as follows:
  - 1. Washed, clean, non-plastic, free from deleterious or foreign matter, symmetrically shaped, natural or manufactured from crushed rock.
  - 2. Do not use limestone screenings, stone dust, or sand for the bedding sand material that does not conform to the grading requirements of ASTM C33.
  - 3. Do not use mason sand or sand conforming to ASTM C 144 for the bedding sand.
  - 4. Where concrete pavers are subject to vehicular traffic, utilize sands that are as hard as practically available.
  - 5. Sieve according to ASTM C 136.
- B. Bedding Sand Material Requirements: Conform to the grading requirements of ASTM C 33 with modifications as shown in Table 1.

## SPECIAL PROVISIONS

TABLE 1  
GRADING REQUIREMENTS FOR BEDDING SAND  
ASTM C 33

<u>Sieve Size</u>	<u>% Passing</u>
3/8 in. (9.5 mm)	100
No. 4 (4.75 mm)	95 to 100
No. 8 (2.36 mm)	85 to 100
No. 16 (1.18 mm)	50 to 85
No. 30 (0.600 mm)	25 to 60
No. 50 (0.300 mm)	10 to 30
No. 100 (0.150 mm)	2 to 10
No. 200 (0.075 mm)	0 to 1 max.

### 2.3 JOINT SAND

A. Provide joint sand as polymeric sand as follows:

1. Polymeric sand shall be Polymeric Sand HP as manufactured by Techniseal, or approved equal.
2. Polymeric sand shall be comprised of graded sand (ASTM C-144) and polymer binders in sealed and labeled containers.
3. Provide color of polymeric sand to best match colors of paver for each paving pattern.
4. Joint Sand Material Requirements: Conform to the grading requirements of ASTM C 144 as shown with modifications in Table 2 below:

TABLE 2  
GRADING REQUIREMENTS FOR JOINT SAND  
ASTM C 144

<u>Sieve Size</u>	<u>ASTM C 144 Natural Sand Percent Passing</u>	<u>ASTM C 144 Manufactured Sand Percent Passing</u>
No. 4 (4.75 mm)	100	100
No. 8 (2.36 mm)	95 to 100	95 to 100
No. 16 (1.18 mm)	70 to 100	70 to 100
No. 30 (0.600 mm)	40 to 75	40 to 100
No. 50 (0.300 mm)	10 to 35	20 to 40
No. 100 (0.150 mm)	2 to 15	10 to 25
No. 200 (0.075 mm)	0 to 1	0 to 10

### 2.4 PAVING AND JOINT SEALER

A. Epoxy acrylic sealer, SUREGUARD or approved equal.

### 2.5 PAVER CLEANER

A. Cleaner shall be Paverprep by PaveChem, or approved equal.

## PART 3 - EXECUTION

## **SPECIAL PROVISIONS**

### 3.1 EXAMINATION

- A. Verify that the subgrade preparation, compacted density, and elevations conform to the specifications.
- B. Verify that aggregate base materials, thickness compaction, surface tolerances, and elevations conform to the Specifications.
- C. Install edge restraints per the Drawings and manufacturer's recommendations.
- D. Verify that the base is dry, uniform, even, and ready to support sand, pavers, and imposed loads.
- E. Beginning of bedding sand and paver installation means acceptance of base and edge restraints.

### 3.2 SITE PREPARATION

- A. The site must be stripped of all topsoil and other objectionable materials to the grades specified.
- B. All subdrainage of underground services within the pavement area must be completed in conjunction with subgrade preparation and before the commencement of subbase construction. All service trenches within the pavement area must be back filled to the sub- grade level with approved material placed in uniform lifts not exceeding 4 inch loose thickness. Each lift must be compacted to at least 100 percent Standard Proctor Maximum Dry Density as specified in ASTM 698.
- C. After trimming to the grades specified, the subgrade is to be proof-rolled to 100 percent Standard Proctor Maximum Dry Density in the presence of the ENGINEER, with soft spots or localized pockets of objectionable material excavated and properly replaced with approved granular material.
- D. The subgrade shall be trimmed to within 0 to 1/2 inch of the specified grades. The surface of the prepared subgrade shall not deviate by more than 1/2 inch from the bottom edge of a 10-foot straight edge laid in any direction. A soil sterilant to inhibit weed growth may be applied at the direction of the ENGINEER.
- E. The CONTRACTOR shall ensure that the prepared subgrade is protected from damage from inundation by surface water. No traffic shall be allowed to cross the prepared subgrade. Repair of any damage resulting shall be the responsibility of the CONTRACTOR and shall be repaired.
- F. Under no circumstances shall further pavement construction proceed until the subgrade has been inspected by the ENGINEER.

### 3.3 PAVER INSTALLATION

- A. The sand shall be spread evenly over the base course and screeded to a nominal 1 inch thickness, not exceeding 1-1/2 inch thickness. The screeded sand should not be disturbed. Sufficient sand shall be placed in order to stay ahead of the laid pavers. Bedding sand shall not be used to fill depressions in the base surface.

## SPECIAL PROVISIONS

- B. Initiation of paver placement shall be deemed to represent acceptance of the pavers.
- C. Pavers shall be free of foreign material before installation.
- D. Pavers shall be inspected for color distribution and all chipped, damaged or discolored pavers shall be replaced.
- E. The pavers shall be laid in the pattern(s) as shown on the Drawings. Straight pattern lines shall be maintained
- F. Joints between the pavers on average shall be between 1/16 inch and 2/16 inch wide.
- G. Gaps at the edges of the paved area shall be filled with cut pavers or edge units. Cut pavers should be no smaller than one-third of the full unit size along edges subject to vehicular traffic.
- H. Pavers to be placed along the edge shall be cut with a double blade paver splitter or masonry saw. Cutting pavers in place with a cutoff saw is prohibited. See CBJ Standard Specification for noise and dust control requirements.
- I. The paver surface shall be swept clean of all debris before compacting, in order to avoid damage from point loads.
- J. A low amplitude, high frequency plate compactor shall be used to compact the pavers into the sand. Use Table 4 below to select size of compaction equipment:

TABLE 4  
PAVER THICKNESS AND REQUIRED MINIMUM  
COMPACTIVE EFFORT

<u>Paver Thickness</u>	<u>Compactive Effort</u>
2-3/8 in.	3,000 lbs
3-1/8 in.	5,000 lbs

- K. The pavers shall be compacted, and dry polymeric joint sand shall be swept into the joints until the joints are full, approximately two or three passes with the compactor. Do not compact within 3-feet of the unrestrained edges of the paving units. Follow manufacturer's recommendations for the application of polymeric joint sand including moisture requirements.
- L. All WORK to within 3-feet of the laying face must be left fully compacted with sand-filled joints at the completion of each day.
- M. Excess joint sand shall be swept off when the job is complete.
- N. The final surface elevations shall not deviate more than 3/8 inch under a 10-foot-long straightedge.
- O. The final surface elevation of pavers shall be 1/8 inch above adjacent drainage inlets, concrete collars or channels to allow for setting.

## **SPECIAL PROVISIONS**

### 3.4 POWER AND JOINT SEALER APPLICATION

- A. All pavers shall be cleaned prior to sealing. Apply paver cleaner per manufacturer's instructions. Apply paver and joint sealer to all pavers, per manufacturer's instructions.

### 3.5 FIELD QUALITY CONTROL

- A. Final elevations shall be checked for conformance to the Drawings after removal of excess joint sand.
- B. Upon completion of the WORK, clean up all WORK areas by removing any debris, surplus material, and equipment from the site.

**END OF SECTION**

***END OF SPECIAL PROVISIONS***

# GOODWIN ROAD RECONSTRUCTION

## CBJ CONTRACT No. BE21-179

### SHEET INDEX

SHEET No.	TITLE
01	COVER SHEET
02	LEGEND, ABBREVIATIONS, AND GENERAL NOTES
03	TYPICAL SECTION, TRAFFIC CONTROL, AND PAVING SEQUENCING
04-06	DETAILS AND SUMMARY TABLES
07-09	HORIZONTAL AND VERTICAL CONTROL, CURB AND GUTTER LAYOUT AND GRADES
10-12	PLAN
13-14	PROFILES

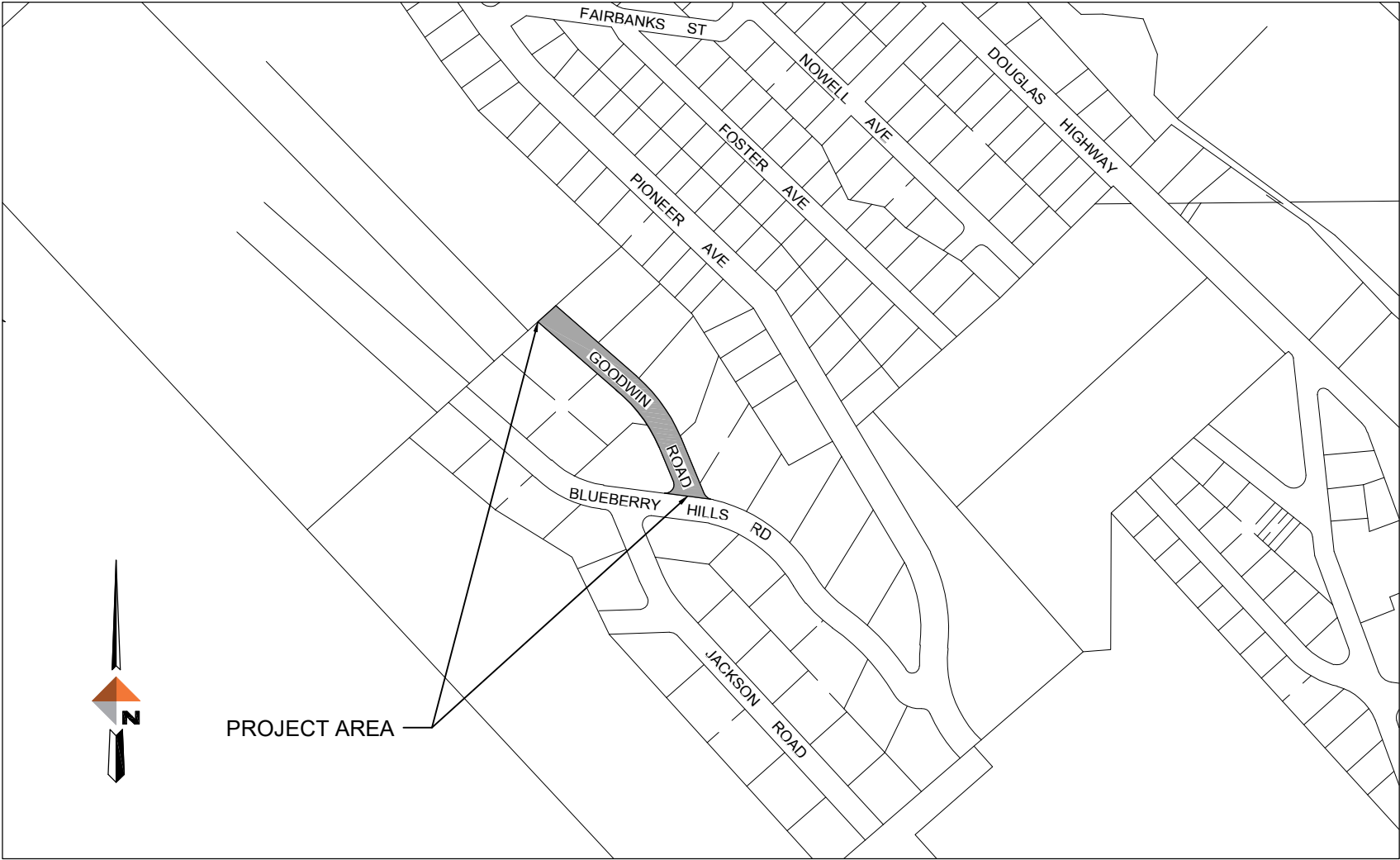

\\JNU-FS\JNU-Projects\22\71078-01\65CAD\Civil\SA20-CT-CV-71078.dwg PLOT DATE: 2020-12-18 12:33 SAVED DATE: 2020-12-18 12:31 USER: csims

PREPARED BY:

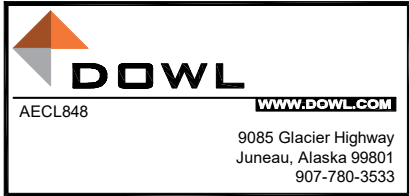

PREPARED FOR:

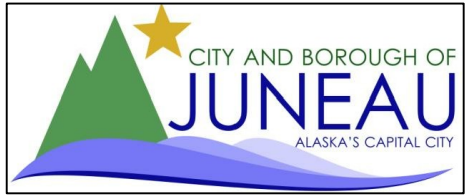

PROJECT	71078.01
DATE	12/18/2020
SHEET	
01	OF 14

# LEGEND

DESCRIPTION	EXISTING	REMOVE	PROPOSED
ADA TILE & RAMP			
BURIED UTILITIES			
CATCH BASIN			
CONTROL POINT			
CURB & GUTTER			
DEPRESSED CURB AND GUTTER			
DITCH CENTER LINE			
EDGE OF ASPHALT			
FIRE HYDRANT			
HEADWALL			
HOUSE NO			
LUMINAIRE			
MAILBOX			
PROJECT CONTROL LINE			
PROPERTY LINE			
SANITARY SEWER CLEANOUT			
SANITARY SEWER FORCE MAIN			
SANITARY SEWER GRAVITY PIPE			
SANITARY SEWER MANHOLE			
SAWCUT			
SIGN			
STORM DRAIN PIPE			
TREE CONIFER			
TREE DECIDUOUS			
WATER LINE PIPE			
WATER VALVE BOX			

# ABBREVIATIONS

AC	ASPHALT CONCRETE
ADA	AMERICAN DISABILITIES ACT
BOP	BEGINNING OF PROJECT
CB	CATCH BASIN
CBJ	CITY AND BOROUGH OF JUNEAU
CMP	CORRUGATED METAL PIPE
CPP	CORRUGATED POLYETHYLENE PIPE
CONC	CONCRETE
CTE	CONNECT TO EXISTING
DI	DUCTILE IRON
DIA	DIAMETER
EL	ELEVATION
EOP	END OF PROJECT
EP	EDGE OF PAVEMENT
FL	FLOW LINE
FG	FINISHED GRADE
FM	FORCE MAIN
GV	GATE VALVE
HDPE	HIGH DENSITY POLYETHYLENE PIPE
INV	INVERT
IP	IRON PIPE
LG	LIP OF GUTTER
LT	LEFT
MH	MANHOLE
MN	MAGNETIC NAIL
MTE	MATCH TO EXISTING
NO	NUMBER
NTS	NOT TO SCALE
PC	POINT OF CURVATURE
PT	POINT OF TANGENT
POC	POINT ON CURVE
PRC	POINT OF REVERSE CURVE
PVC	POLYVINYL CHLORIDE
ROW	RIGHT-OF-WAY
RT	RIGHT
SD	STORM DRAIN
SHLD	SHOULDER
SS	SANITARY SEWER
STA	STATION
STD	STANDARD
TBC	TOP BACK OF CURB
TBVG	TOP BACK OF VALLEY GUTTER
TP	TOP OF PAVEMENT
TYP	TYPICAL
UD	UNDERDRAIN

# GENERAL NOTES

- BEGIN SUBCUT AT 24 INCHES FROM PAVEMENT SAWCUT LINE AT STREET CONNECTIONS, UNLESS OTHERWISE SHOWN ON THE DRAWINGS, OR DIRECTED BY THE ENGINEER. REMOVE AND REPLACE BASE COURSE WITH 6 INCHES OF 2" MINUS SHOT ROCK W/BASE COURSE TO 12 INCHES FROM PAVEMENT SAWCUT LINE. SAWCUT AS NECESSARY ALONG ALL STREET AND DRIVEWAY APPROACHES TO PROVIDE A NEAT MATCH LINE.
- CONTRACTOR SHALL ENSURE UNINTERRUPTED GARBAGE PICKUP AND DAILY MAIL SERVICE TO ALL RESIDENCES IMPACTED BY THIS PROJECT.
- THE 4TH EDITION OF THE CBJ STANDARD DETAILS, DATED AUGUST 14 2011, IS MADE PART OF THIS CONTRACT, WITH CURRENT REVISIONS AS APPLICABLE.
- ALL EXISTING STORM DRAIN PIPES (6 INCH DIAMETER AND LARGER), AND APPURTENANCES (TO BE ABANDONED) THAT ARE WITHIN THE STREET LIMITS, SHALL BE REMOVED AND DISPOSED OF, UNLESS OTHERWISE NOTED.
- EXISTING PIPE LOCATIONS ARE DERIVED FROM CBJ AS-BUILTS OR FIELD LOCATED. ACTUAL LOCATIONS MAY VARY FROM THOSE SHOWN. DEPTH OF THE EXISTING PIPES SHOWN ON THE PROFILES ARE ASSUMED. CONTRACTOR SHALL FIELD VERIFY THE LOCATION OF EACH EXISTING SERVICE PIPE PRIOR TO INSTALLING MAIN LINE TEES AND WYES FOR THE STORM AND SANITARY SEWER. DIAL BEFORE YOU DIG 586-1333.
- THE GRADING AND ALIGNMENT ARE SUBJECT TO MINOR REVISIONS BY THE ENGINEER.
- LOCATION OF CULVERTS AND CULVERT LENGTHS ARE SUBJECT TO MINOR REVISIONS BY THE ENGINEER.
- THE CONTRACTOR SHALL NOTIFY CBJ WATER UTILITIES AT 586-0393 OF ANY WATER MAIN INTERRUPTION.
- A MINIMUM CLEARANCE OF 18-INCHES SHALL BE OBTAINED BETWEEN WATER AND SEWER PIPES. IN SOME LOCATIONS STORM SEWER CULVERTS WILL REQUIRE THAT THE WATER LINES BE INSTALLED WITH MORE THAN 60-INCHES OF COVER.
- PROPERTY LINE LOCATIONS USED IN THESE PLANS ARE DERIVED FROM RECORD PLATS AND DO NOT REPRESENT A BOUNDARY SURVEY. EXISTING RECORD PLATS DO NOT CLOSE WITH EACH OTHER IN SOME CASES. THE PROPERTY LINES SHOWN ON THESE PLANS ARE A BEST FIT APPROXIMATION OF CLOSURE.
- ALL ITEMS DESIGNATED TO BE REMOVED SHALL BE DISPOSED OF AT AN APPROVED DISPOSAL SITE, EXCEPT AS NOTED IN THE CONTRACT DOCUMENTS.
- CONTRACTOR SHALL REFERENCE ALL EXISTING PROPERTY CORNER MONUMENTS (I.E. REBARS, CONCRETE NAILS, BRASS CAP MONUMENT AND ETC.) PRIOR TO CONSTRUCTION, REMONUMENT AFTER SURFACING IS REPLACED, AND SUBMIT A RECORD OF MONUMENT TO THE ENGINEER. ALL WORK SHALL BE DONE BY, OR UNDER THE DIRECTION OF, AN ALASKA REGISTERED LAND SURVEYOR.
- ALL ASPHALT AND CHIP SEAL PAVEMENT TO BE REMOVED AND DISPOSED OF SHALL BE DELIVERED TO A STOCKPILE AREA AT THE LEMON CREEK CITY PIT TO BE DESIGNATED BY THE ENGINEER. CONTACT THE ENGINEER FOR THE EXACT LOCATION OF THE STOCKPILE.
- AEL&P, ACS, AND GCI MAY CONDUCT WORK WITHIN THE PROJECT LIMITS TO RELOCATE UTILITIES AND UPGRADE THEIR RESPECTIVE SYSTEMS. THE CONTRACTOR SHALL COORDINATE ITS ACTIVITIES WITH EACH UTILITY COMPANY AND PROVIDE ACCESS AS NECESSARY FOR UTILITY COMPANIES TO CONDUCT THEIR WORK.
- THE CONTRACTOR SHALL RESTRICT ITS COMPACTION AND OTHER VIBRATION INDUCING OPERATIONS AS NECESSARY TO ENSURE NO DAMAGE OCCURS TO ADJACENT BUILDINGS OR STRUCTURES. REFER TO SECTION 01530, ARTICLE 1.7 FOR FURTHER REQUIREMENTS.
- THE PLAN SHEETS DO NOT SHOW ALL OF THE TREES AND OTHER VEGETATION THAT WILL BE ENCOUNTERED DURING CONSTRUCTION ACTIVITIES. NO TREES OR OTHER VEGETATION ARE TO BE REMOVED OR DAMAGED, UNLESS SHOWN ON THE DRAWINGS OR DIRECTED BY THE ENGINEER.
- THE CONTRACTOR SHALL NOT STORE MATERIALS OR EQUIPMENT, OR OPERATE EQUIPMENT WITH ITS TRACKS OR WHEELS PLACED ON PRIVATE PROPERTY, WITHOUT WRITTEN APPROVAL OF THE PROPERTY OWNER.
- THE CONTRACTOR SHALL NOTIFY EACH RESIDENT OF EACH DRIVEWAY CLOSURE THE DAY PRECEDING THE DAY THE DRIVEWAY IS TO BE CLOSED TO VEHICULAR ACCESS. THE RESIDENT SHALL BE INFORMED OF THE PERIOD OF TIME THE CLOSURE WILL BE IN EFFECT. NO DRIVEWAY CLOSURES WILL BE PERMITTED UNTIL THIS REQUIREMENT HAS BEEN MET TO THE SATISFACTION OF THE ENGINEER.
- "JUMPING JACK" OR SIMILAR TYPE COMPACTORS SHALL BE USED TO THOROUGHLY COMPACT ALL LAYERS OF MATERIAL AROUND WATER VALVE BOXES, CATCH BASINS, MANHOLES AND OTHER STRUCTURES.
- THE CONTRACTOR SHALL INSTALL AND MAINTAIN ENGINEER APPROVED EROSION CONTROL DEVICES DURING CONSTRUCTION PER SECTION 01570.

REVISIONS			
REV	DATE	DESCRIPTION	BY

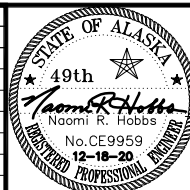

**DOWL**  
AECL848  
www.dowl.com  
9085 Glacier Highway  
Juneau, Alaska 99801  
907-780-3533



GOODWIN ROAD RECONSTRUCTION  
BE21-179  
LEGEND, ABBREVIATIONS,  
AND GENERAL NOTES

PROJECT	71078.01
DATE	12/18/2020
SHEET	
02 OF 14	

\\JNU-FS\JNU-Projects\22\71078-01\65CAD\Civil\SA20-CT-LD-71078.dwg PLOT DATE: 2020-12-18 12:33 SAVED DATE: 2020-12-14 10:25 USER: csims

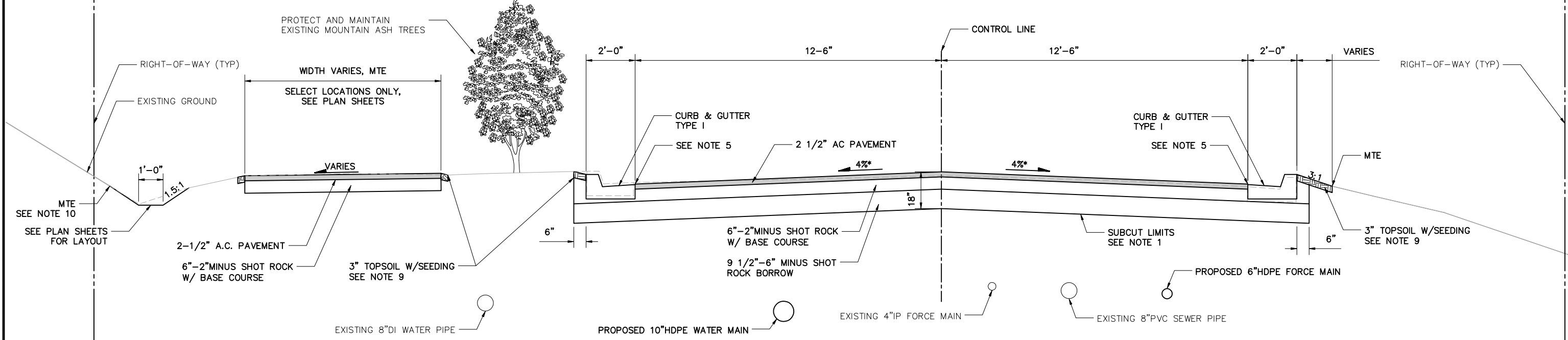

**GOODWIN ROAD**  
BOP TO ~STA 16+50, NTS

\* UNLESS OTHERWISE SHOWN ON GRADING SHEETS

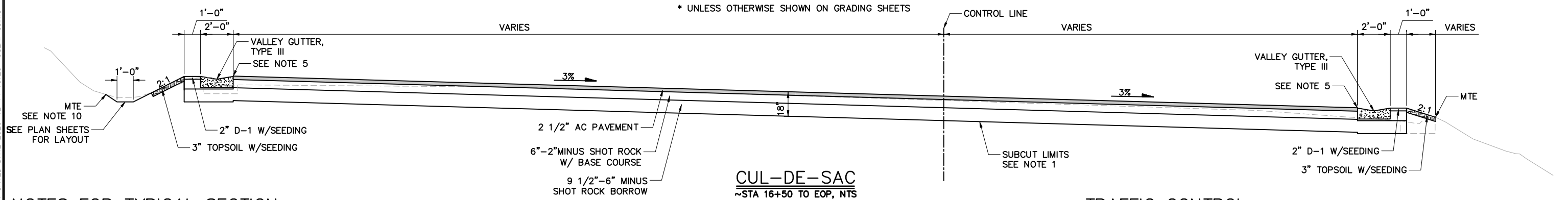

**CUL-DE-SAC**  
~STA 16+50 TO EOP, NTS

**NOTES FOR TYPICAL SECTION**

- IF ORGANIC OR OTHER UNSUITABLE MATERIALS ARE FOUND AT OR NEAR THE PLANNED SUBCUT LEVEL, ADDITIONAL EXCAVATION MAY BE REQUIRED AS DIRECTED BY THE ENGINEER. USABLE MATERIAL FROM EXCAVATION SHALL BE USED TO BACKFILL THE ADDITIONAL AREAS OF EXCAVATION, WHICH MAY VARY FROM 6" IN DEPTH TO A DEPTH OF UP TO 5'-0" BELOW FINISH GRADE. THE BACKFILLING WITH USABLE MATERIAL FROM EXCAVATION WILL BE CONSIDERED INCIDENTAL TO EXCAVATION.
- SANITARY SEWER AND WATER SERVICES ARE NOT SHOWN ON THE TYPICAL SECTION. SEE PLAN VIEW DRAWINGS FOR LOCATIONS.
- SEE HORIZONTAL AND VERTICAL CONTROL, CURB AND GUTTER LAYOUT AND GRADE DRAWINGS FOR GRADING DETAILS.
- DEPTH AND HORIZONTAL LOCATION OF EXISTING UNDERGROUND ELECTRICAL, WATER, AND SANITARY SEWER VARIES. SEE PLAN SHEETS FOR APPROXIMATE LOCATIONS.
- TOP OF ASPHALT CONCRETE PAVEMENT SHALL BE 1/4 INCH ABOVE THE LIP OF CONCRETE GUTTER. TOP OF PAVEMENT GRADES AND SLOPES GIVEN ON THE PLANS REFLECT THE ACTUAL FINISH PAVEMENT SURFACE.
- THE 2-INCH MINUS SHOT ROCK W/BASE COURSE COURSE LAYER SHALL BE 4" TO 5" OF 2-INCH MINUS SHOT ROCK WITH 1" TO 2" TOP LAYER OF BASE COURSE, GRADING D-1 FOR A TOTAL THICKNESS OF 6". THE 2-INCH MINUS SHOT ROCK SHALL BE COMPACTED WITH VIBRATORY EQUIPMENT PRIOR TO PLACING THE BASE COURSE GRADING D-1.
- DRIVEWAYS DISTURBED DURING CONSTRUCTION SHALL BE RECONSTRUCTED TO EQUAL OR BETTER CONDITION WITH SUBGRADE REPLACED IN LAYERS TO MATCH THOSE REMOVED EXCEPT:
  - PAVED DRIVEWAYS SHALL BE SUBCUT TO 18 INCHES BELOW FINISH GRADE AND REPLACED WITH 9-1/2" OF 6-INCH MINUS SHOT ROCK BORROW, 6" OF 2-INCH MINUS WITH BASE COURSE, AND 2-1/2" OF A.C. PAVEMENT.
  - ALL WORK REQUIRED TO RECONSTRUCT GRAVEL DRIVEWAYS BEYOND THE BACK OF EXISTING CURB WILL BE CONSIDERED INCIDENTAL TO OTHER WORK AND NO ADDITIONAL PAYMENT WILL BE MADE.
  - ORGANICS, ROOTS, WOOD OR OTHER DELETERIOUS MATERIALS ENCOUNTERED IN THE DRIVEWAYS DURING EXCAVATION OPERATIONS SHALL NOT BE REPLACED, BUT SHALL BE DISPOSED OF AT AN APPROVED DISPOSAL SITE. BACKFILL VOIDS BELOW THE REQUIRED SUBBASE LAYERS WITH USABLE MATERIAL FROM EXCAVATION.
- ALL EXISTING SEWER PIPES AND WATER PIPES (6-INCH DIAMETER AND LARGER), AND APPURTENANCES (TO BE ABANDONED) WITHIN THE STREET LIMITS SHALL BE REMOVED AND DISPOSED OF OR FILLED WITH CEMENTITIOUS SLURRY, UNLESS OTHERWISE NOTED.
- GRADE BEYOND THE LIMITS OF THE IMPROVEMENTS AS REQUIRED TO MATCH TO EXISTING AT A 3:1 OR LESS CUT OR FILL SLOPE. PLACE USABLE EXCAVATION BENEATH THE 3" TOPSOIL LAYER WHERE A FILL GREATER THAN 3" IS REQUIRED.
- GRADE BACK SLOPE OF DITCH AS REQUIRED TO MATCH TO EXISTING AT A 1.5:1 CUT SLOPE OR AS NOTED ON PLAN SHEETS.
- ALL AREAS DISTURBED BY CONSTRUCTION ACTIVITIES NOT RESURFACED WITH ASPHALT PAVEMENT OR CONCRETE SHALL BE GRADED TO A UNIFORM, WELL DRAINED APPEARANCE AND COVERED WITH TOPSOIL AND SEEDED, AS DIRECTED BY THE ENGINEER.

REVISIONS			
REV	DATE	DESCRIPTION	BY

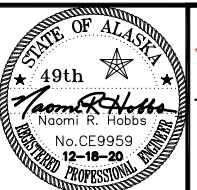

**DOWL**  
AECL848  
WWW.DOWL.COM  
9085 Glacier Highway  
Juneau, Alaska 99801  
907-780-3533



**TRAFFIC CONTROL**

- ALL TRAFFIC TO BE CONTROLLED PER THE REQUIREMENTS OF THE ALASKA TRAFFIC MANUAL (U.S. DEPARTMENT OF TRANSPORTATION "MANUAL ON UNIFORM TRAFFIC CONTROL DEVICES" AND THE ALASKA SUPPLEMENT).
- ROAD CLOSURES WILL BE PERMITTED ONLY AS APPROVED BY THE ENGINEER.
- THE CONTRACTOR WILL NOT BE PERMITTED TO OBSTRUCT VEHICULAR TRAFFIC BETWEEN THE HOURS OF 4:30pm AND 8:00am SEVEN DAYS A WEEK. DURING THIS PERIOD, ONE LANE SHALL BE OPEN TO VEHICULAR TRAFFIC AND WITH A MINIMUM TOTAL WIDTH OF 8 FEET.
- PROVIDE ACCESS FOR EMERGENCY VEHICLES AT ALL TIMES.
- A MINIMUM OF ONE LANE (8 FOOT MINIMUM WIDTH) SHALL BE KEPT OPEN TO VEHICULAR TRAFFIC AT ALL TIMES, EXCEPT A FIVE (5) MINUTE MAXIMUM STOPPAGE TO VEHICULAR TRAFFIC WILL BE PERMITTED, WITH NO MORE THAN ONE TRAFFIC STOPPAGE PER HOUR. THIS REQUIREMENT DOES NOT APPLY FOR THE DAY OF PAVING.

**PAVING SEQUENCING**

- LAYDOWN OPERATIONS SHALL BE CONDUCTED IN A MANNER WHICH ENSURES THAT THE MINIMUM TEMPERATURE ALONG THE CENTERLINE EDGE OF THE FIRST PAVED LANE DOES NOT FALL BELOW 200F BEFORE THE SECOND LANE IS PAVED.

GOODWIN ROAD RECONSTRUCTION  
BE21-179

TYPICAL SECTION, TRAFFIC CONTROL  
AND PAVING SEQUENCING

PROJECT	71078.01
DATE	12/18/2020
SHEET	
03 OF 14	

\\FS-VNU-Projects\22\71078-01\65CAD\Civil\SA20-CT-TS-71078.dwg PLOT DATE: 2020-12-18 12:34. SAVED DATE: 2020-12-14 10:25. USER: csims



# CORROSION PROTECTION SPECIFICATIONS AND NOTES:

## ANODES

- ANODES SHALL BE 18-LBS BARE WEIGHT ZINC WITH PREPACKAGED ANODE BACKFILL.
- ACCEPTABLE ANODE MODELS ARE:
  - MODEL NO. ZUR-18 FROM FARWEST INDUSTRIES
  - MODEL S18 FROM MESA PRODUCTS
  - APPROVED EQUAL
- INSTALL TYPE, SIZE, AND NUMBER OF ANODES SPECIFIED.
- INSTALL 2 ANODES TO ALL CONNECTIONS TO EXISTING C.I. OR D.I. PIPE 12-INCH DIAMETER AND LARGER.
- CONDUCTOR WIRE SHALL BE A MINIMUM OF 10- FEET IN LENGTH, SIZE #8 OR LARGER, AND INSULATED WITH HIGH MOLECULAR WEIGHT POLYETHYLENE (HMWPE).
- PREPACKAGED ANODE SHALL BE SATURATED WITH WATER PRIOR TO BACKFILL.
- ANODES SHALL BE PLACED IN NATIVE EARTH BACKFILL. DO NOT PLACE IN PIPE BEDDING MATERIAL.

## THERMITE (EXOTHERMIC) WELDING

- THERMITE WELD MATERIALS SHALL BE DESIGNED FOR CONNECTION OF COPPER TO DUCTILE IRON AND CAST IRON SURFACES AND SHALL BE INSTALLED PER MANUFACTURERS INSTRUCTIONS.
- ACCEPTABLE MANUFACTURES OF THERMITE WELD PRODUCTS ARE:
  - CADWELD BY ERICO PRODUCTS INC.
  - THERMOWELD BY CONTINENTAL INDUSTRIES INC.
  - APPROVED EQUAL
- A 2-INCH SQUARE AREA IN THE PIPE SURFACE SHALL BE GROUND CLEAN PER MANUFACTURERS RECOMMENDATIONS PRIOR TO THERMITE WELDING.
- WIRE ENDS SHALL HAVE PROPER ADAPTER SLEEVES TO ENSURE PROPER BOND. #8 AWG SHALL HAVE ADAPTER SLEEVES SPECIFIED BY THERMITE WELD MANUFACTURER. FIELD INSTALLED SLEEVES SHALL HAVE WIRE CONDUCTOR EXTEND 1/4-INCH BEYOND ENDS OF SLEEVE.
- WIRE CONNECTION SHALL BE TESTED FOR INTEGRITY PRIOR TO COATING.
- CONTINUITY STRAPS SHALL BE #2 AWG COPPER STRANDED WIRE WITH THW INSULATION AND SHALL BE ATTACHED TO THE PIPE BY THERMITE WELDING AND COATED AND SEALED AS DESCRIBED BELOW.

## COATING AND SEALING

- ALL THERMITE WELDS SHALL BE PROTECTED AND SEALED BY:
  - PREFABRICATED THERMITE WELD CAPS, SIZED ACCORDING TO WIRE SIZE, MINIMUM DIMENSIONS OF 4-INCH BY 4-INCH FILLED WITH ELASTOMERIC MASTIC COATING OR,
  - HEAT SHRINK SLEEVE PIPE ENCASEMENT AFTER COATING THERMITE WELD WITH ELASTOMERIC MASTIC COATING - HEAT SHRINK SLEEVE SHALL BE CANUSA AQUA SEAL OR APPROVED EQUAL.
- ALL PIPE SURFACE COATING DAMAGED BEYOND THE WELD CAPS OR HEAT SHRINK SHALL BE COATED WITH PROTAL 7125 FROM DENSO NORTH AMERICA OR APPROVED EQUAL.

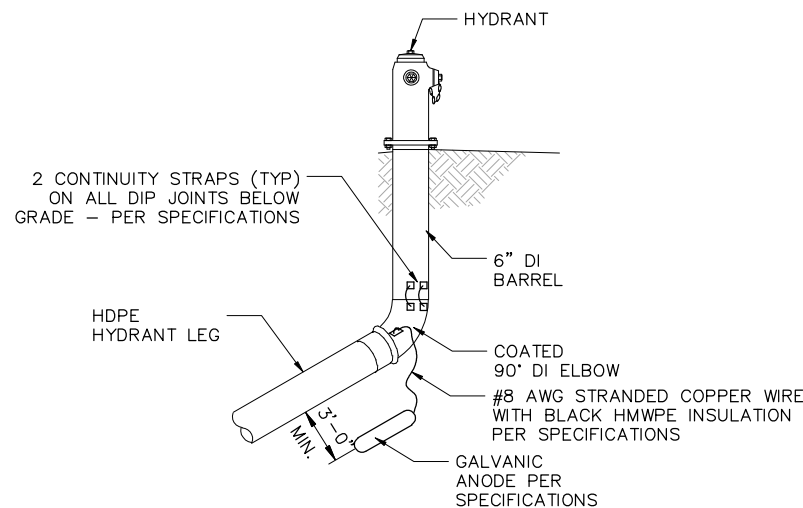

**GALVANIC ANODE INSTALLATION AT HYDRANT ASSEMBLIES W/ HDPE**

NTS

## SEWER SERVICE SUMMARY

HOUSE NUMBER	LOCATION	COMMENTS
#3000 BLUEBERRY	11+29.8, 34.9 LT	SEE NOTE 4
#3000 GOODWIN	11+57.9, 25.3 RT	SEE NOTE 4 AND 5
#3004 GOODWIN	12+08.1, 25.3 RT	SEE NOTE 4 AND 5
#3005 GOODWIN	13+34.6, 34.4 LT	SEE NOTE 4
#3008 GOODWIN	16+15.9, 25.3 RT	SEE NOTE 3 AND 5
#3009 GOODWIN	16+11.3, 34.7 LT	SEE NOTE 3
#3012 GOODWIN	16+17.6, 25.3 RT	SEE NOTE 3 AND 5
#3031 GOODWIN	16+60.5, 45.5 LT	SEE NOTE 3
USMS 59 TR B LUCY LODE	17+15.0, 5.7 RT	SEE NOTE 3

### NOTES:

- SEWER SERVICE LOCATIONS SHOWN ARE FROM LIMITED AS-BUILT INFORMATION AND WERE NOT FIELD LOCATED. CONTRACTOR SHALL FIELD LOCATE ALL SEWER SERVICES TO CONFIRM FINAL LOCATION FOR NEW SEWER SERVICE CLEANOUT INSTALLATION.
- STATION AND OFFSET ARE GIVEN TO THE CENTER OF THE NEW CLEANOUT COVER.
- INSTALL NEW 4" PVC SEWER SERVICE WITH CLEANOUT PER CBJ STANDARD DETAIL 213 AND CONNECT TO EXISTING SEWER SERVICE AT PROPERTY LINE.
- INSTALL NEW CLEANOUT ON EXISTING SERVICE AT PROPERTY LINE PER DETAIL 2 SHEET 5.
- PRIOR TO INSTALLATION OF CLEANOUT, CONFIRM LOCATION OF PRESSURE SANITARY SEWER SERVICE LATERAL CONNECTION. INSTALL CLEANOUT WITHIN GRAVITY SERVICE A MINIMUM OF 1-FT FROM CONNECTION.

## RECONSTRUCT MAILBOX TABLE

HOUSE NUMBER	LOCATION	COMMENTS
#3000 GOODWIN	11+33.8, 18.5 RT	3.5' CANTILEVER ARM SINGLE MAILBOX
#3004 GOODWIN	12+15.4, 18.5 RT	3.5' CANTILEVER ARM SINGLE MAILBOX
#3005 GOODWIN	13+12.0, 18.5 LT	3.5' CANTILEVER ARM SINGLE MAILBOX
#3009 GOODWIN	15+69.1, 18.5 LT	3.5' CANTILEVER ARM SINGLE MAILBOX

### NOTES:

- STATION AND OFFSET ARE GIVEN TO CENTER OF VERTICAL 4"x4" POST. CONTRACTOR SHALL STAKE MAILBOX POST LOCATION FOR APPROVAL BY THE ENGINEER.
- REINSTALL EXISTING MAILBOX AND NEWSPAPER RECEPTACLES TO NEW POST AND ARM ASSEMBLIES. IF THE RECEPTACLES ARE DAMAGED BY THE CONTRACTOR, NEW RECEPTACLES OF SAME SIZE, COLOR AND STYLE WITH NEW HOUSE NUMBERS SHALL BE PROVIDED BY THE CONTRACTOR.
- MAIL DELIVERY SERVICE SHALL NOT BE INTERRUPTED AND ACCESS TO EACH MAILBOX RECEPTACLE SHALL BE AVAILABLE TO THE UNITED STATES POSTAL SERVICE AND THE RESIDENTS AT ALL TIMES.

## COVER, FRAME AND GRATE SUMMARY

STRUCTURE NO.	EAST JORDAN IRON WORKS, OLYMPIC FOUNDRY CO., CBJ STANDARD No., OR APPROVED EQUAL
CB-1	EJ 7701 T2 HOOD W/T100 M2 GRATE
CB-2	EJ 7701 T2 HOOD W/T100 M2 GRATE
CB-3	EJ 7701 T2 HOOD W/T100 M2 GRATE
CB-4	EJ 7701 T2 HOOD W/T100 M2 GRATE
CB-5	EJ 7701 T2 HOOD W/T100 M2 GRATE
CB-6	EJ 7701 T2 HOOD W/T100 M1 GRATE
CB-7	EJ 7701 T2 HOOD W/T100 M1 GRATE
MH-1	EXISTING TO REMAIN
MH-2	EJ 3700ZPT 3705APT DI
MH-3	EJ 3700ZPT 3705APT DI
MH-4	EJ 3700ZPT 3705APT DI
MH-5	EJ 3700ZPT 3705APT DI

### NOTES:

- CATCH BASIN TOP SLAB OPENINGS SHALL BE DIMENSIONED TO FIT THE FRAME DIMENSIONS. ALL COVERS SHALL BE HEAVY DUTY CONSTRUCTION AND BICYCLE SAFE. ALL FRAMES AND GRATES SHALL BE DUCTILE IRON.
- LOCAL FLOW LINE DEPRESSION AT CATCH BASIN SHALL BE 3/8", WITH 36" TRANSITIONS TO EACH SIDE OF THE FRAME, UNLESS OTHERWISE DIRECTED BY THE ENGINEER.
- ALL CATCH BASIN FINISHED GRADES (FG) PROVIDED ARE TO THE FLOWLINE OF THE FRAME AT THE LONGITUDINAL CENTER OF THE FRAME AFTER APPLICATION OF THE LOCALIZED DEPRESSION. FOR TYPE I CURB & GUTTER THE FG IS 0.56 BELOW THE TBC.
- ALL MANHOLE FINISHED GRADES (FG) PROVIDED ARE TO THE CENTER OF COVER AFTER APPLICATION OF 3/8" DEPRESSION PER STD 205.

## WATER SERVICE SUMMARY

HOUSE NUMBER	LOCATION	SIZE/TYPE	COMMENTS
#3000 BLUEBERRY	11+27.3, 36.9 LT	1" POLY - SIDR7	CTE
#3000 GOODWIN	11+60.3, 28.5 RT	1" POLY - SIDR7	CTE
#3004 GOODWIN	11+98.4, 23.1 RT	1" POLY - SIDR7	CTE
#3005 GOODWIN	13+23.9, 34.5 LT	1" POLY - SIDR7	CTE
#3008 GOODWIN	16+27.5, 25.3 RT	1" POLY - SIDR7	CTE
#3009 GOODWIN	16+25.3, 34.6 LT	1" POLY - SIDR7	CTE
#3012 GOODWIN	16+27.9, 25.3 RT	1" POLY - SIDR7	CONFIRM CTE OR INSTALL THREADED CAP FOR FUTURE CONNECTION
USMS 59 TR B LUCY LODE	17+16.6, 3.8 LT	2" POLY - SIDR7	INSTALL THREADED CAP FOR FUTURE CONNECTION

### NOTES:

- STATION AND OFFSET ARE GIVEN TO THE CENTER OF THE VALVE BOX.
- INSTALL NEW WATER SERVICE, CURB STOP, AND CURB BOX PER CBJ STANDARD DETAIL 406A.

REVISIONS			
REV	DATE	DESCRIPTION	BY

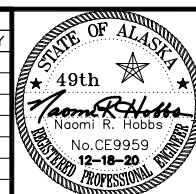

**DOWL**  
AECL848  
WWW.DOWL.COM  
9085 Glacier Highway  
Juneau, Alaska 99801  
907-780-3533

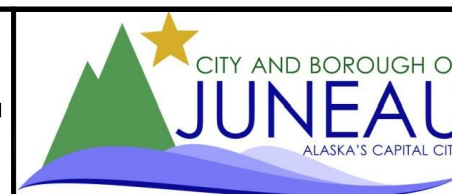

GOODWIN ROAD RECONSTRUCTION  
BE21-179  
CORROSION PROTECTION DETAILS  
AND SUMMARY TABLES

PROJECT	71078.01
DATE	12/18/2020
SHEET	04 OF 14

\\JNU-FS\JNU-Projects\22\71078-01\65CAD\Civil\SA20-CT-DT-71078A.dwg PLOT DATE 2020-12-18 12:34 SAVED DATE 2020-12-14 10:25 USER: csims

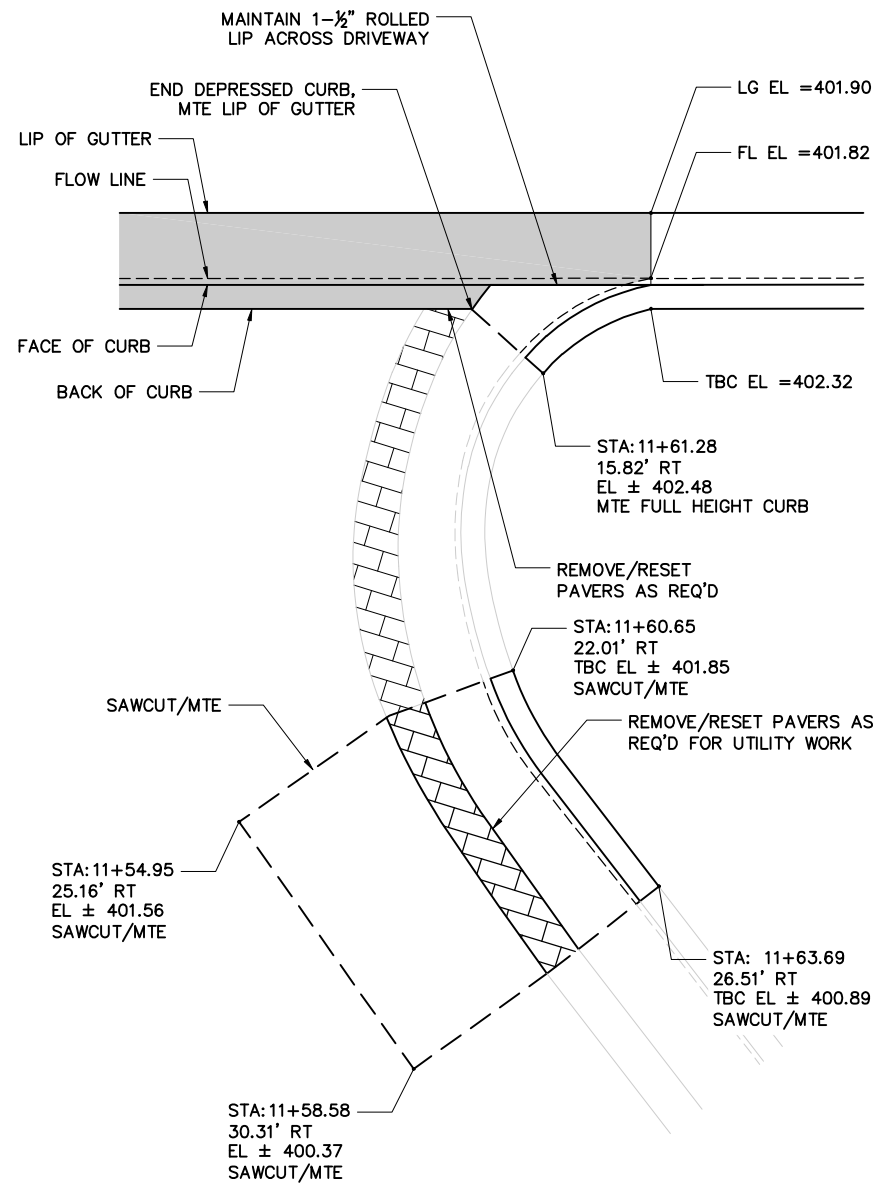

1 #3000 MATCH TO EXISTING CURB  
 NTS

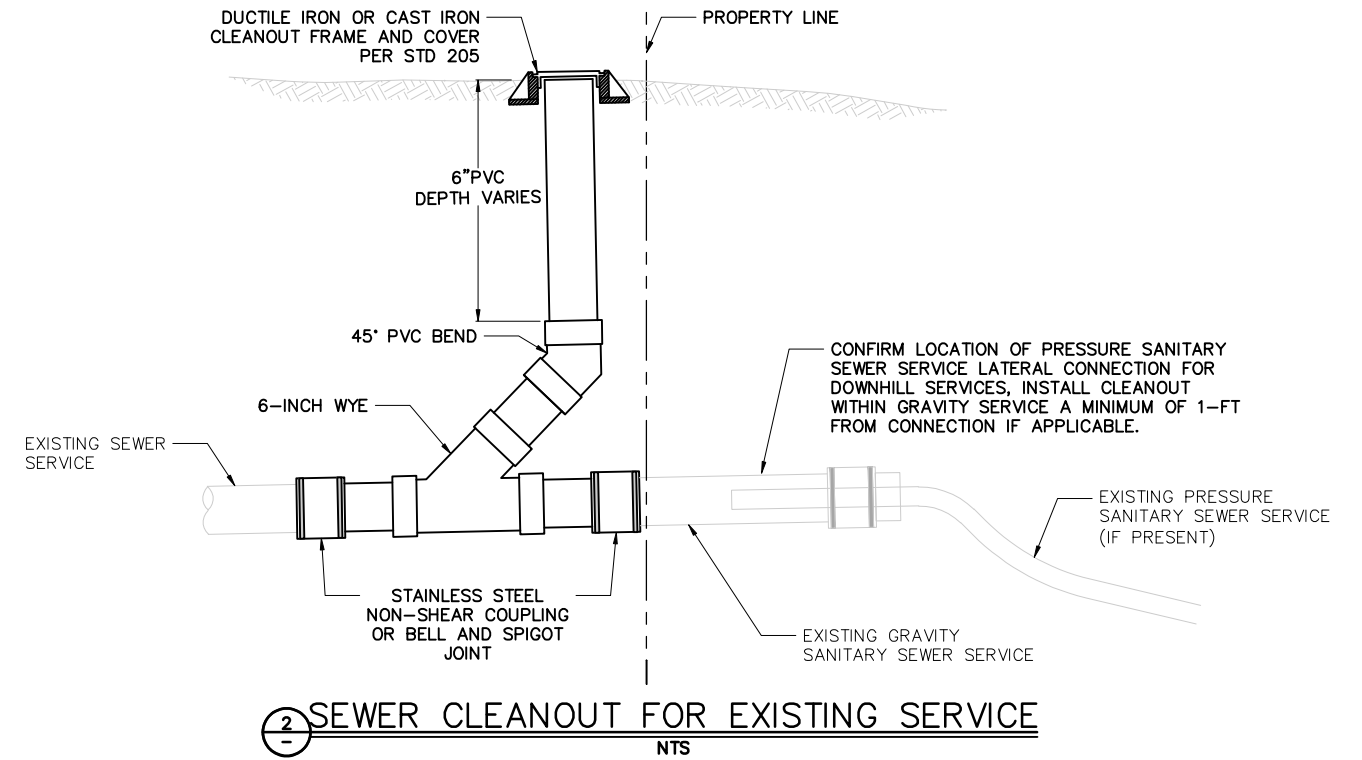

2 SEWER CLEANOUT FOR EXISTING SERVICE  
 NTS

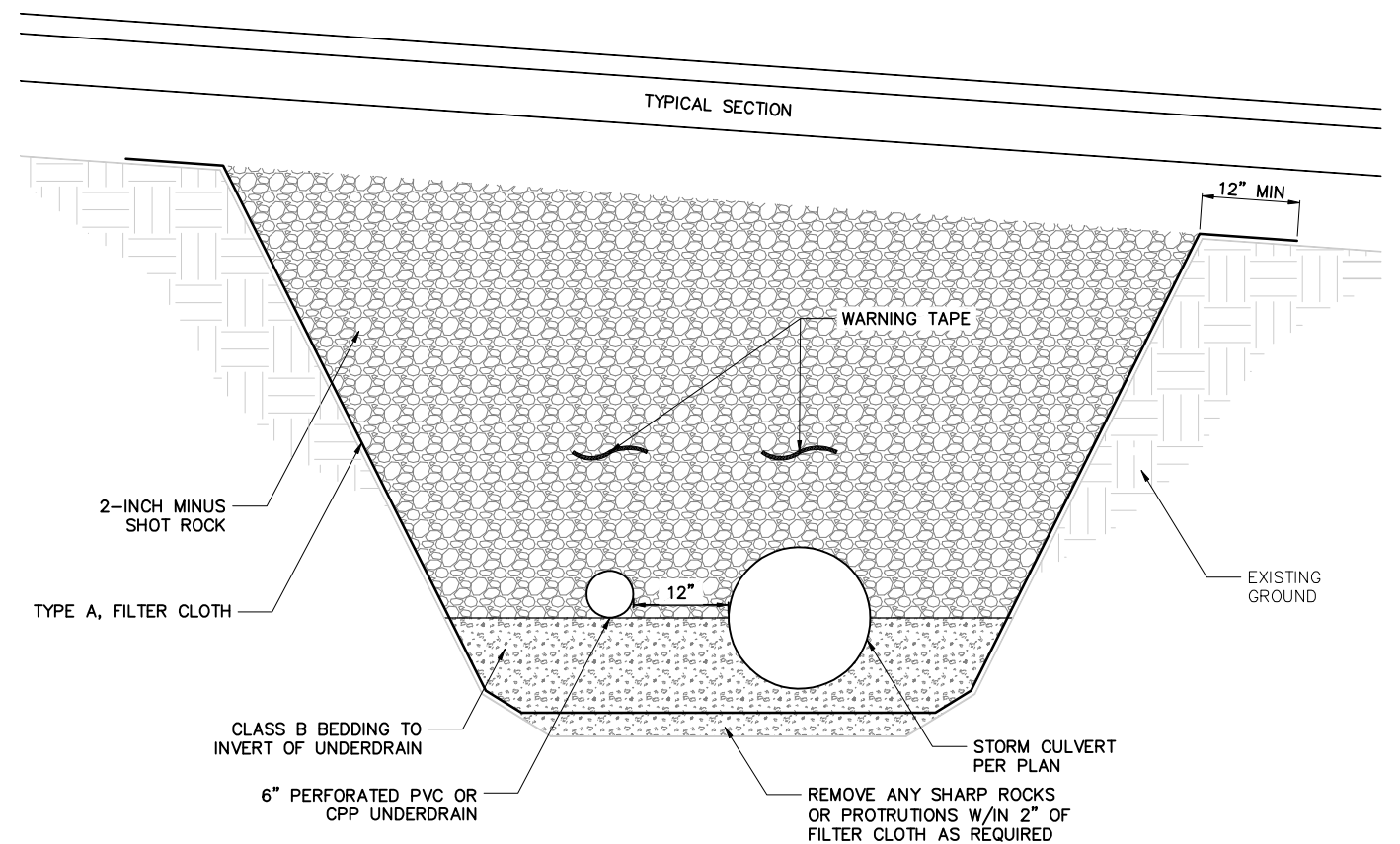

3 STORM DRAIN TRENCH WITH UNDERDRAIN  
 NTS

REVISIONS			
REV	DATE	DESCRIPTION	BY

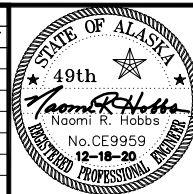

**DOWL**  
 AECL848  
 WWW.DOWL.COM  
 9085 Glacier Highway  
 Juneau, Alaska 99801  
 907-780-3533



GOODWIN ROAD RECONSTRUCTION  
 BE21-179  
 MISCELLANEOUS DETAILS

PROJECT	71078.01
DATE	12/18/2020
SHEET	05 OF 14

\\JNU-FS\JNU-Projects\22\71078-01\65CAD\Civil\SA20-CT-DT-71078A.dwg PLOT DATE 2020-12-18 12:34 SAVED DATE 2020-12-14 10:25 USER: csims

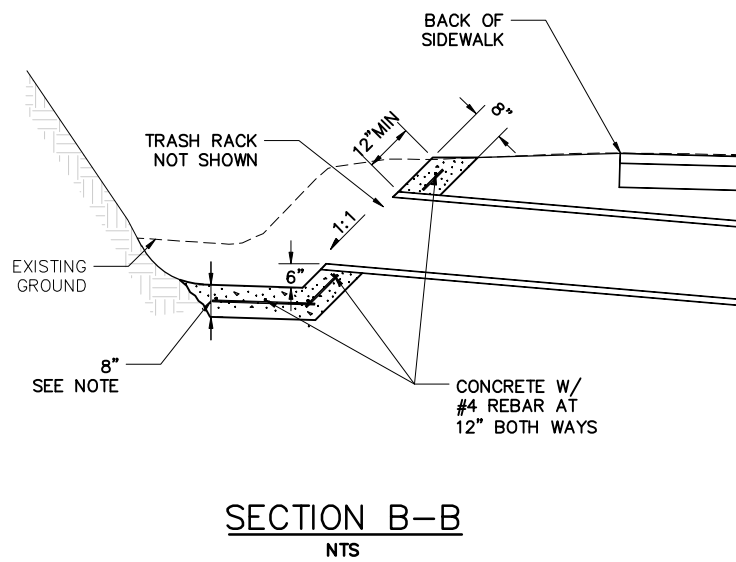
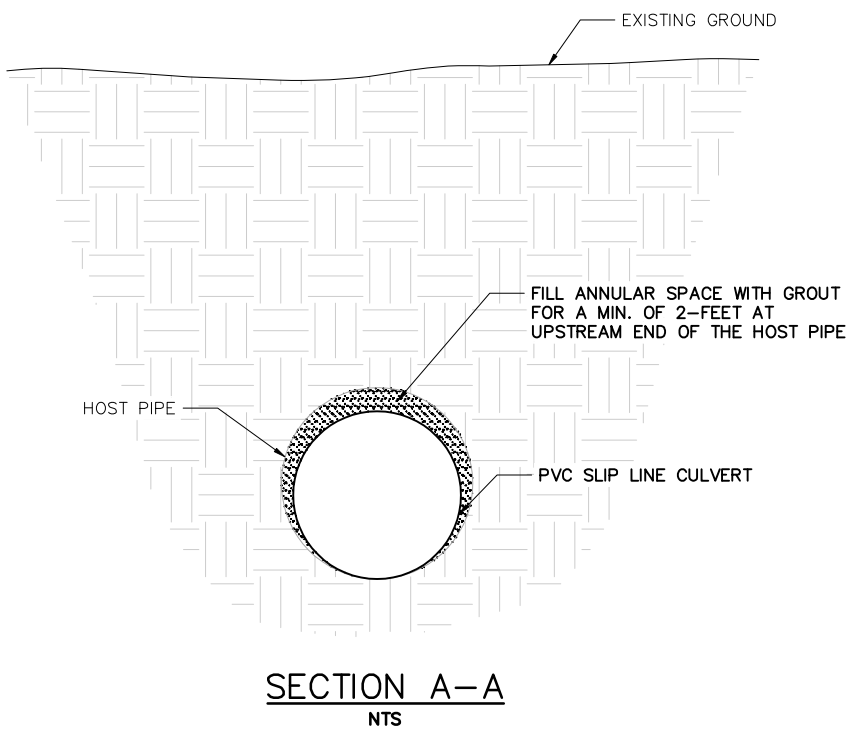
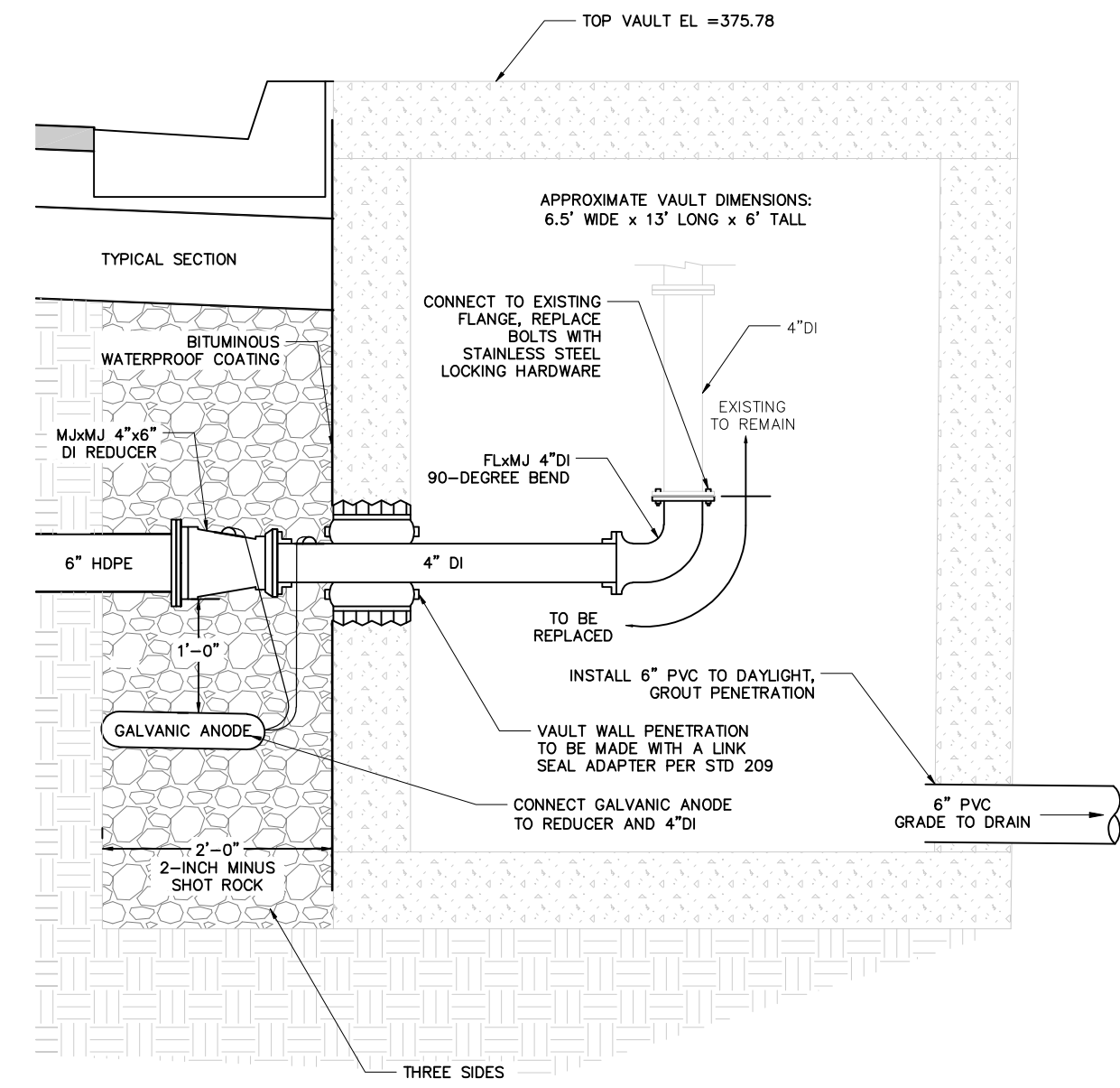
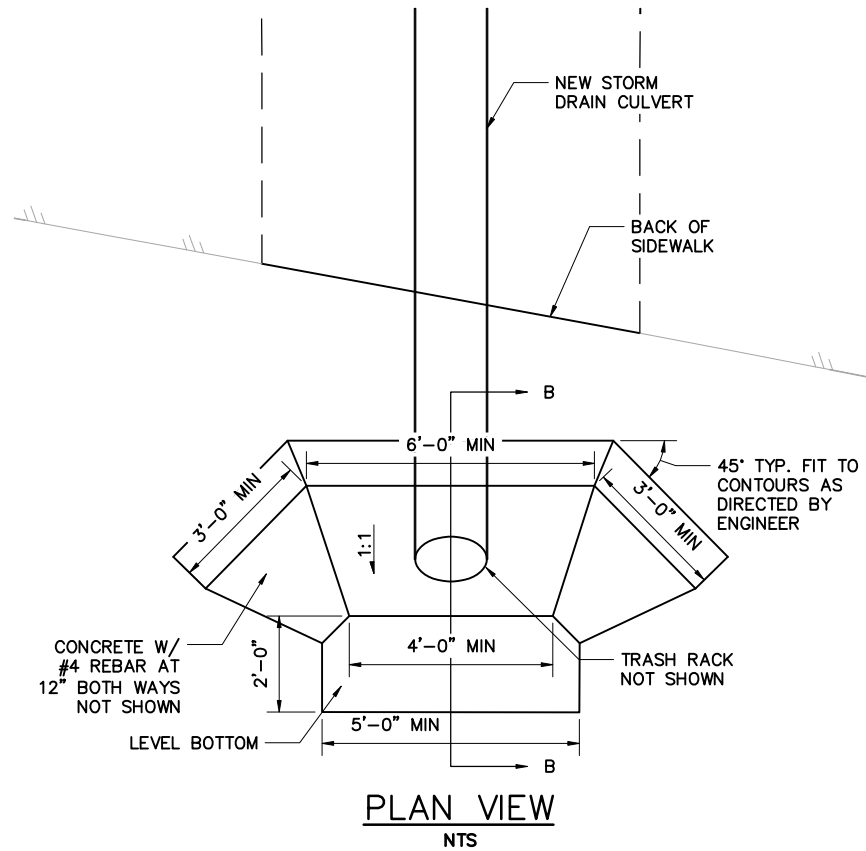
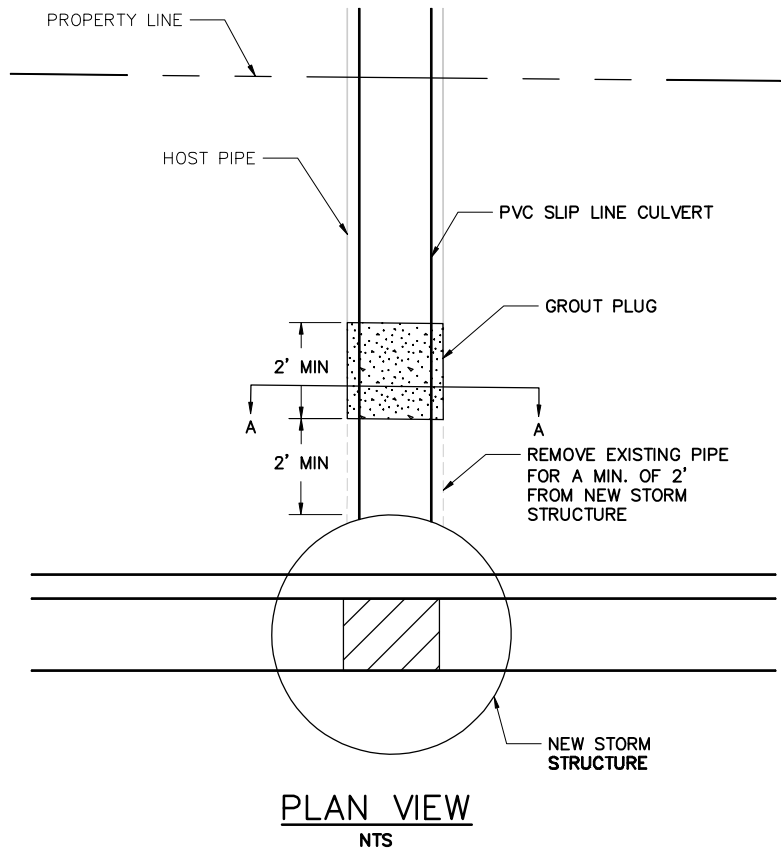

**1** STORM DRAIN - SLIPLINE  
 NTS

**2** CONCRETE HEADWALL WITH TRASHRACK  
 NTS

**3** LIFT STATION CONNECTION DETAIL  
 NTS

NOTE: REMOVE ALL LOOSE SHALE AND DEBRIS FOR INSTALLATION OF HEADWALL IF BEDROCK IS ENCOUNTERED AT LESS THAN 14-INCHES BELOW CULVERT INVERT, THE HEADWALL FLOOR THICKNESS MAY BE DECREASED AS DIRECTED BY THE ENGINEER.

REVISIONS			
REV	DATE	DESCRIPTION	BY

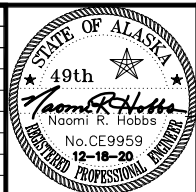

**DOWL**  
 AECL848  
 www.dowl.com  
 9085 Glacier Highway  
 Juneau, Alaska 99801  
 907-780-3533

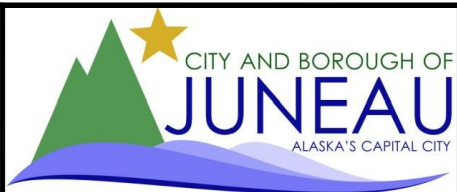

GOODWIN ROAD RECONSTRUCTION  
 BE21-179  
 MISCELLANEOUS DETAILS

PROJECT	71078.01
DATE	12/18/2020
SHEET	06 OF 14

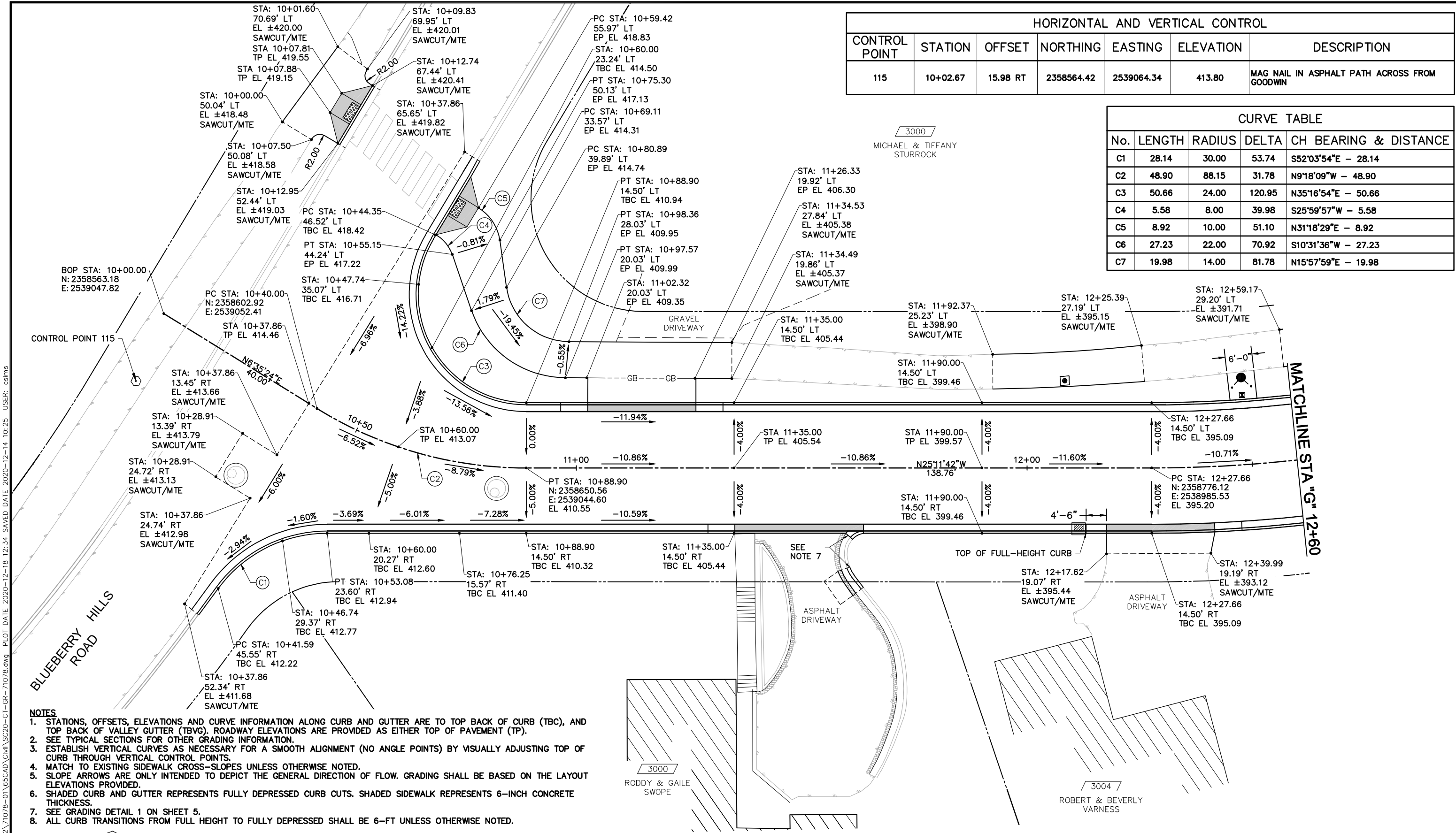

HORIZONTAL AND VERTICAL CONTROL						
CONTROL POINT	STATION	OFFSET	NORTHING	EASTING	ELEVATION	DESCRIPTION
115	10+02.67	15.98 RT	2358564.42	2539064.34	413.80	MAG NAIL IN ASPHALT PATH ACROSS FROM GOODWIN

CURVE TABLE					
No.	LENGTH	RADIUS	DELTA	CH BEARING & DISTANCE	
C1	28.14	30.00	53.74	S52°03'54"E - 28.14	
C2	48.90	88.15	31.78	N9°18'09"W - 48.90	
C3	50.66	24.00	120.95	N35°16'54"E - 50.66	
C4	5.58	8.00	39.98	S25°59'57"W - 5.58	
C5	8.92	10.00	51.10	N31°18'29"E - 8.92	
C6	27.23	22.00	70.92	S10°31'36"W - 27.23	
C7	19.98	14.00	81.78	N15°57'59"E - 19.98	

- NOTES**
1. STATIONS, OFFSETS, ELEVATIONS AND CURVE INFORMATION ALONG CURB AND GUTTER ARE TO TOP BACK OF CURB (TBC), AND TOP BACK OF VALLEY GUTTER (TBVG). ROADWAY ELEVATIONS ARE PROVIDED AS EITHER TOP OF PAVEMENT (TP).
  2. SEE TYPICAL SECTIONS FOR OTHER GRADING INFORMATION.
  3. ESTABLISH VERTICAL CURVES AS NECESSARY FOR A SMOOTH ALIGNMENT (NO ANGLE POINTS) BY VISUALLY ADJUSTING TOP OF CURB THROUGH VERTICAL CONTROL POINTS.
  4. MATCH TO EXISTING SIDEWALK CROSS-SLOPES UNLESS OTHERWISE NOTED.
  5. SLOPE ARROWS ARE ONLY INTENDED TO DEPICT THE GENERAL DIRECTION OF FLOW. GRADING SHALL BE BASED ON THE LAYOUT ELEVATIONS PROVIDED.
  6. SHADED CURB AND GUTTER REPRESENTS FULLY DEPRESSED CURB CUTS. SHADED SIDEWALK REPRESENTS 6-INCH CONCRETE THICKNESS.
  7. SEE GRADING DETAIL 1 ON SHEET 5.
  8. ALL CURB TRANSITIONS FROM FULL HEIGHT TO FULLY DEPRESSED SHALL BE 6-FT UNLESS OTHERWISE NOTED.

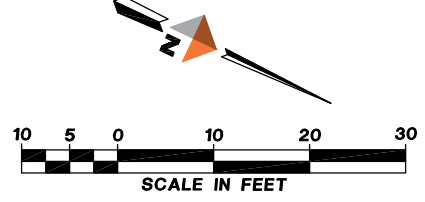

REVISIONS			
REV	DATE	DESCRIPTION	BY

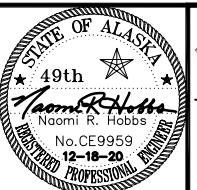

**DOWL**  
AECL848  
www.dowl.com  
9085 Glacier Highway  
Juneau, Alaska 99801  
907-780-3533



GOODWIN ROAD RECONSTRUCTION  
BE21-179  
HORIZONTAL AND VERTICAL CONTROL  
CURB AND GUTTER LAYOUT AND GRADES  
BLUEBERRY HILLS RD TO STA "G" 12+60

PROJECT	71078.01
DATE	12/18/2020
SHEET	07 OF 14

**NOTES**

1. STATIONS, OFFSETS, ELEVATIONS AND CURVE INFORMATION ALONG CURB AND GUTTER ARE TO TOP BACK OF CURB (TBC), AND TOP BACK OF VALLEY GUTTER (TBVG). ROADWAY ELEVATIONS ARE PROVIDED AS EITHER TOP OF PAVEMENT (TP)..
2. SEE TYPICAL SECTIONS FOR OTHER GRADING INFORMATION.
3. ESTABLISH VERTICAL CURVES AS NECESSARY FOR A SMOOTH ALIGNMENT (NO ANGLE POINTS) BY VISUALLY ADJUSTING TOP OF CURB THROUGH VERTICAL CONTROL POINTS.
4. MATCH TO EXISTING SIDEWALK CROSS-SLOPES UNLESS OTHERWISE NOTED..
5. SLOPE ARROWS ARE ONLY INTENDED TO DEPICT THE GENERAL DIRECTION OF FLOW. GRADING SHALL BE BASED ON THE LAYOUT ELEVATIONS PROVIDED.
6. SHADED CURB AND GUTTER REPRESENTS FULLY DEPRESSED CURB CUTS.
7. ALL CURB TRANSITIONS FROM FULL HEIGHT TO FULLY DEPRESSED SHALL BE 6-FT UNLESS OTHERWISE NOTED.

HORIZONTAL AND VERTICAL CONTROL						
CONTROL POINT	STATION	OFFSET	NORTHING	EASTING	ELEVATION	DESCRIPTION
201	13+15.96	21.15 LT	2358835.26	2538920.56	385.75	MAG NAIL IN ASPHALT PATH

CURVE TABLE				
No.	LENGTH	RADIUS	DELTA	CH BEARING & DISTANCE
C8	127.08	295.00	24.68	N37°32'11"W - 127.08

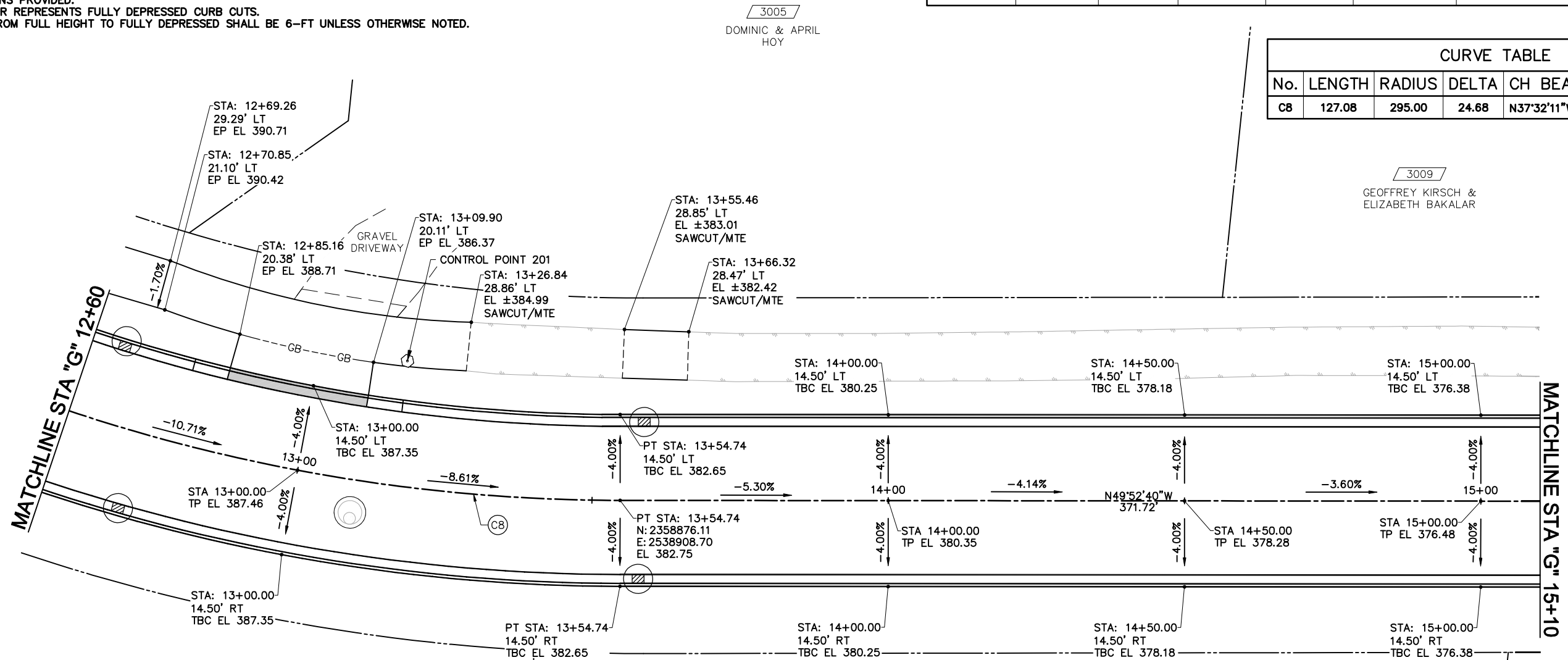

3005  
DOMINIC & APRIL HOY

3009  
GEOFFREY KIRSCH & ELIZABETH BAKALAR

3004  
ROBERT & BEVERLY VARNES

3008  
KELLIE & SHAUN LEWIS

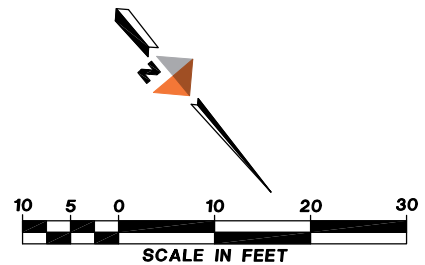

REVISIONS			
REV	DATE	DESCRIPTION	BY

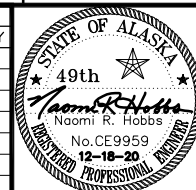

**DOWL**  
AECL848  
WWW.DOWL.COM  
9085 Glacier Highway  
Juneau, Alaska 99801  
907-780-3533



GOODWIN ROAD RECONSTRUCTION  
BE21-179  
HORIZONTAL AND VERTICAL CONTROL  
CURB AND GUTTER LAYOUT AND GRADES  
STA "G" 12+60 TO STA "G" 15+10

PROJECT	71078.01
DATE	12/18/2020
SHEET	08 OF 14

\\JNU-FS\JNU-Projects\22\71078-01\65CAD\Civil\SC20-CT-GR-71078.dwg PLOT DATE: 2020-12-18 12:34 SAVED DATE: 2020-12-14 10:25 USER: csims

**NOTES**

- STATIONS, OFFSETS, ELEVATIONS AND CURVE INFORMATION ALONG CURB AND GUTTER ARE TO TOP BACK OF CURB (TBC), AND TOP BACK OF VALLEY GUTTER (TBVG). ROADWAY ELEVATIONS ARE PROVIDED AS EITHER TOP OF PAVEMENT (TP).
- SEE TYPICAL SECTIONS FOR OTHER GRADING INFORMATION.
- ESTABLISH VERTICAL CURVES AS NECESSARY FOR A SMOOTH ALIGNMENT (NO ANGLE POINTS) BY VISUALLY ADJUSTING TOP OF CURB THROUGH VERTICAL CONTROL POINTS.
- MATCH TO EXISTING SIDEWALK CROSS-SLOPES UNLESS OTHERWISE NOTED.
- SLOPE ARROWS ARE ONLY INTENDED TO DEPICT THE GENERAL DIRECTION OF FLOW. GRADING SHALL BE BASED ON THE LAYOUT ELEVATIONS PROVIDED.
- SHADED CURB AND GUTTER REPRESENTS FULLY DEPRESSED CURB CUTS.
- ALL CURB TRANSITIONS FROM FULL HEIGHT TO FULLY DEPRESSED SHALL BE 6-FT UNLESS OTHERWISE NOTED.

HORIZONTAL AND VERTICAL CONTROL						
CONTROL POINT	STATION	OFFSET	NORTHING	EASTING	ELEVATION	DESCRIPTION
204	15+33.60	15.52' RT	2359003.31	2538783.27	375.79	MAG NAIL IN CONCRETE PAD AT LIFT STATION

CURVE TABLE					
No.	LENGTH	RADIUS	DELTA	CH BEARING & DISTANCE	
C9	52.98	68.00	44.64	N72°11'46"W - 52.98	
C10	41.89	68.00	35.29	S32°13'51"E - 41.89	
C11	181.47	40.00	259.93	N35°27'02"E - 181.47	

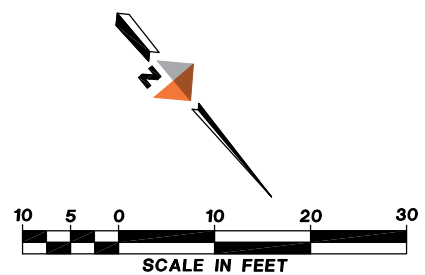
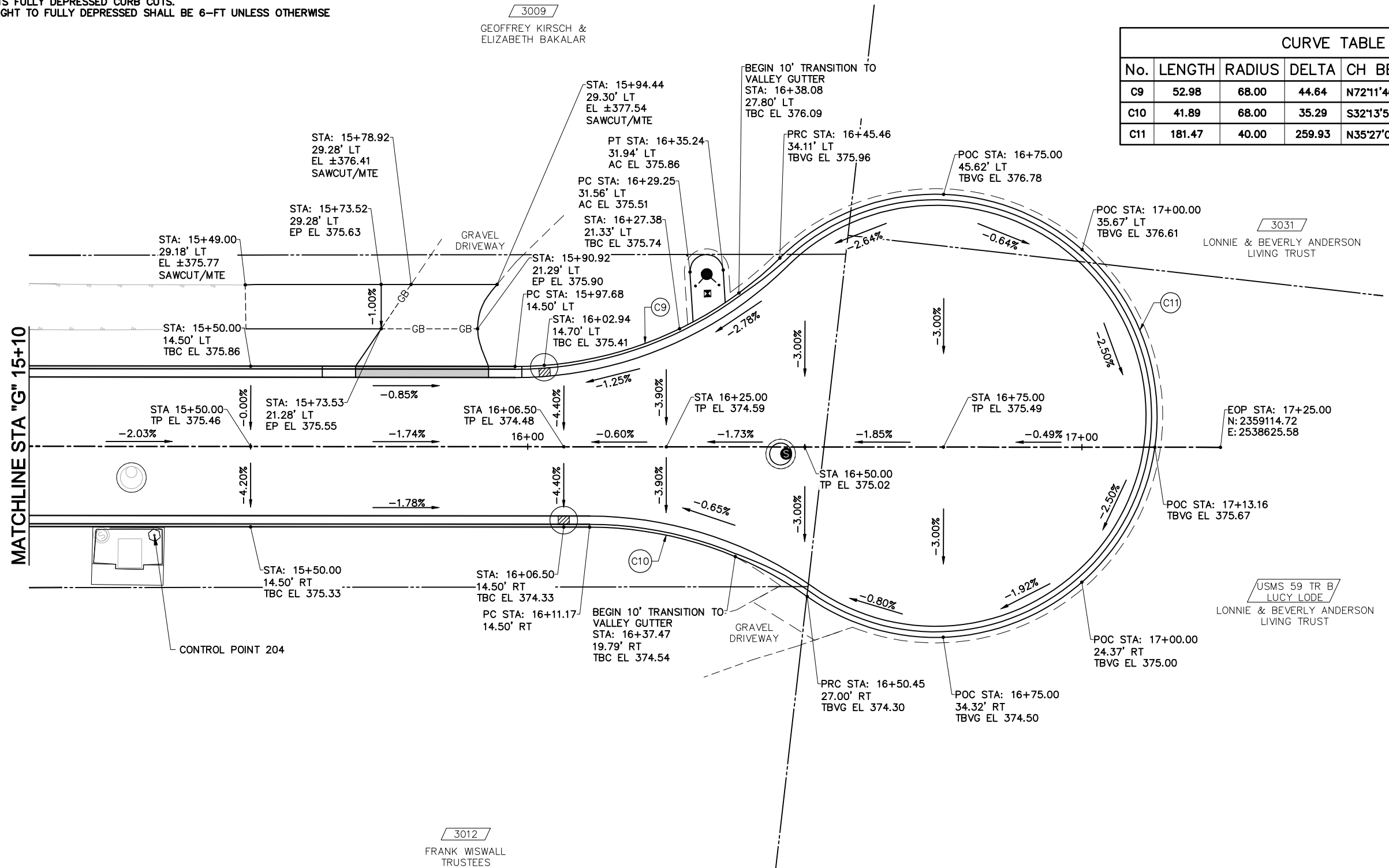

REVISIONS			
REV	DATE	DESCRIPTION	BY

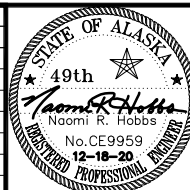

**DOWL**  
 AECL848  
 WWW.DOWL.COM  
 9085 Glacier Highway  
 Juneau, Alaska 99801  
 907-780-3533



GOODWIN ROAD RECONSTRUCTION  
 BE21-179  
 HORIZONTAL AND VERTICAL CONTROL  
 CURB AND GUTTER LAYOUT AND GRADES  
 STA "G" 15+10 TO EOP

PROJECT	71078.01
DATE	12/18/2020
SHEET	09 OF 14

\\JNU-FS\JNU-Projects\22\71078-01\65CAD\Civil\SC20-CT-GR-71078.dwg PLOT DATE: 2020-12-18 12:34 SAVED DATE: 2020-12-14 10:25 USER: csims

**NOTES:**

1. STORM DRAIN STRUCTURE STATION AND OFFSET IS GIVEN TO THE CENTER OF THE STRUCTURE. ALL FINISHED GRADES (FG) PROVIDED ARE TO THE FLOWLINE OF THE FRAME AT THE LONGITUDINAL CENTER OF THE FRAME AFTER APPLICATION OF THE LOCALIZED DEPRESSION.
2. PIPE LENGTHS AND SLOPES SHOWN ARE CALCULATED TO ENDS OF PIPE. PAY LENGTHS ARE TO CENTER OF STRUCTURE.
3. INSTALL NEW WATER SERVICE, SEE SUMMARY ON SHEET 04.
4. INSTALL NEW SEWER SERVICE CLEANOUT, SEE SUMMARY ON SHEET 04.
5. CTE 10"HDPE AT APPROXIMATE STA 10+52. PROVIDE TEMPORARY WATER TO ALL EFFECTED RESIDENTS DURING CONSTRUCTION.
6. SAWCUT ALONG BACK OF CURB, PROTECT EXISTING ASPHALT DRIVEWAY.
7. REMOVE AND REPLACE PAVERS FOR SEWER AND WATER SERVICE CONNECTIONS.
8. EXTENTS OF EXISTING 18"CMP UNKNOWN. REMOVE SEGMENT WITHIN ROADWAY. CRUSH AT PROPERTY LINE PROJECT RT AND INSTALL GROUT PLUG AT INLET OF PRIVATE STORM STRUCTURE AT ~STA 12+12.2, 33.1 RT.
9. RELOCATE EXISTING UTILITIES AS REQUIRED FOR INSTALLATION OF CB-1 AND SD-1.
10. PROTECT AND MAINTAIN EXISTING MOUNTAIN ASH TREES.
11. INSTALL CORROSION PROTECTION ANODE IF APPLICABLE.

PIPE SUMMARY - STORM SEWER AND SANITARY SEWER				
PIPE	DIA	LENGTH	TYPE	SLOPE
SD-1	12"	61.1'	CPP	0.147
SS-1	6"	508.4	HDPE	VARIES

CB-1, TYPE III	
STA "G" 12+11.5, 13.5' RT	
FG	EL=396.41
SD-1	EL=394.20
INV 6"UD	EL=394.30
SUMP 16" MIN	

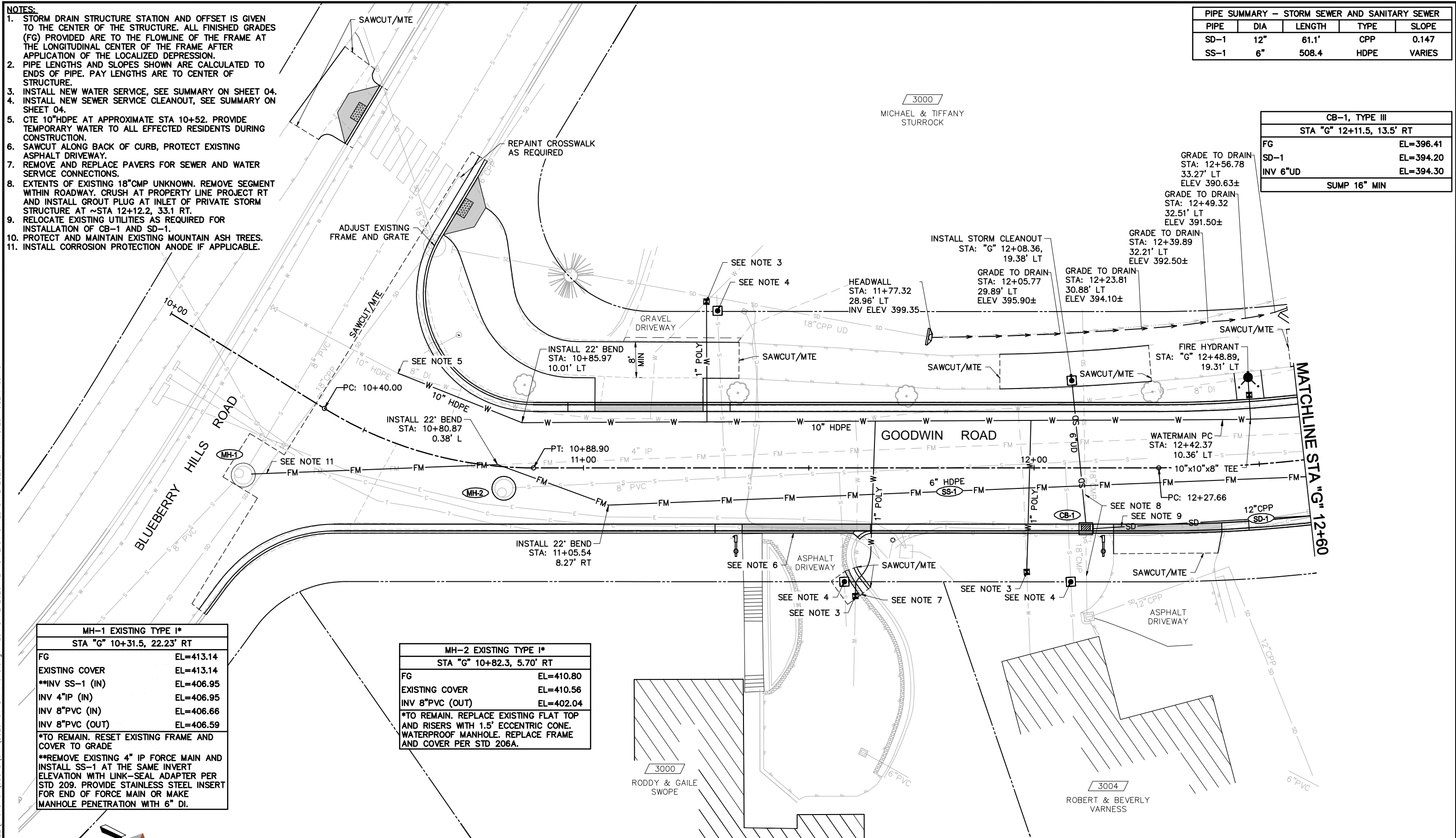

MH-1 EXISTING TYPE I*	
STA "G" 10+31.5, 22.23' RT	
FG	EL=413.14
EXISTING COVER	EL=413.14
**INV SS-1 (IN)	EL=406.95
INV 4"IP (IN)	EL=406.95
INV 8"PVC (IN)	EL=406.66
INV 8"PVC (OUT)	EL=406.59
*TO REMAIN. RESET EXISTING FRAME AND COVER TO GRADE	
**REMOVE EXISTING 4" IP FORCE MAIN AND INSTALL SS-1 AT THE SAME INVERT ELEVATION WITH LINK-SEAL ADAPTER PER STD 209. PROVIDE STAINLESS STEEL INSERT FOR END OF FORCE MAIN OR MAKE MANHOLE PENETRATION WITH 6" DI.	

MH-2 EXISTING TYPE I*	
STA "G" 10+82.3, 5.70' RT	
FG	EL=410.80
EXISTING COVER	EL=410.56
INV 8"PVC (OUT)	EL=402.04
*TO REMAIN. REPLACE EXISTING FLAT TOP AND RISERS WITH 1.5' ECCENTRIC CONE. WATERPROOF MANHOLE. REPLACE FRAME AND COVER PER STD 206A.	

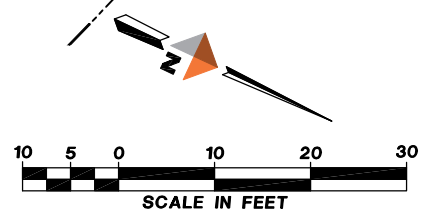

REVISIONS			
REV	DATE	DESCRIPTION	BY

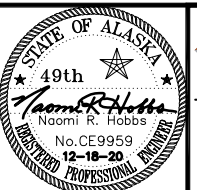

**DOWL**  
AECL848  
www.dowl.com  
9085 Glacier Highway  
Juneau, Alaska 99801  
907-780-3533



GOODWIN ROAD RECONSTRUCTION  
BE21-179  
PLAN - GOODWIN ROAD  
BLUEBERRY HILLS RD TO STA "G" 12+60

PROJECT	71078.01
DATE	12/18/2020
SHEET	10 OF 14

- NOTES:**
- STORM DRAIN STRUCTURE STATION AND OFFSET IS GIVEN TO THE CENTER OF THE STRUCTURE. ALL FINISHED GRADES (FG) PROVIDED ARE TO THE FLOWLINE OF THE FRAME AT THE LONGITUDINAL CENTER OF THE FRAME AFTER APPLICATION OF THE LOCALIZED DEPRESSION.
  - PIPE LENGTHS AND SLOPES SHOWN ARE CALCULATED TO ENDS OF PIPE. PAY LENGTHS ARE TO CENTER OF STRUCTURE.
  - INSTALL NEW WATER SERVICE, SEE SUMMARY ON SHEET 04.
  - INSTALL NEW SEWER SERVICE CLEANOUT, SEE SUMMARY ON SHEET 04.
  - RELOCATE EXISTING UTILITIES AS REQUIRED FOR INSTALLATION OF CB-3 AND SD-1.
  - PROTECT AND MAINTAIN EXISTING MOUNTAIN ASH TREES.
  - HAND CLEAR TREES OVERHANGING PATHWAY AS DIRECTED BY ENGINEER.

PIPE SUMMARY - STORM SEWER AND SANITARY SEWER				
PIPE	DIA	LENGTH	TYPE	SLOPE
SD-1		**SEE SHEET 10**		
SD-2	18"	17.6'	CPP	0.115
SD-3	18"	24.2'	CPP	0.053
SD-4	15"	13.7'	PVC	SLIPLINE
SD-5	18"	18.1	CPP	0.135
SD-6	18"	22.5'	CPP	0.119
SD-7	15"	14.9'	PVC	SLIPLINE
SS-1		**SEE SHEET 10**		

CB-2 TYPE I	
STA "G" 12+65.9, 14.17' LT	
FG	EL=390.44
INV SD-2	EL=386.85
INV SD-3	EL=386.70
INV 6"UD	EL=387.70
16" MIN SUMP	

CB-4 TYPE I	
STA "G" 13+58.8, 13.25' LT	
FG	EL=381.87
INV SD-5	EL=377.58
INV SD-6	EL=377.62
INV 6"UD	EL=378.62
16" MIN SUMP	

MH-3 EXISTING TYPE I*	
STA "G" 13+09.9, 6.53' RT	
FG	EL=386.31
EXISTING COVER	EL=385.90
INV 8"PVC (IN)	EL=380.15
INV 8"PVC (OUT)	EL=379.97
*TO REMAIN. WATERPROOF MANHOLE. REPLACE EXISTING RISERS, FRAME AND COVER. REPLACE FRAME AND COVER PER STD 206A.	

CB-5 TYPE I	
STA "G" 13+57.8, 13.25' RT	
FG	EL=381.92
INV SD-6	EL=374.95
INV SD-7	EL=373.79
INV 6"UD	EL=375.45
16" MIN SUMP	

CB-3 TYPE I	
STA "G" 12+72.6, 13.25 RT	
FG	EL=389.72
INV SD-1	EL=385.43
INV SD-3	EL=385.43
INV SD-4	EL=383.43
INV 6"UD	EL=385.93
16" MIN SUMP	

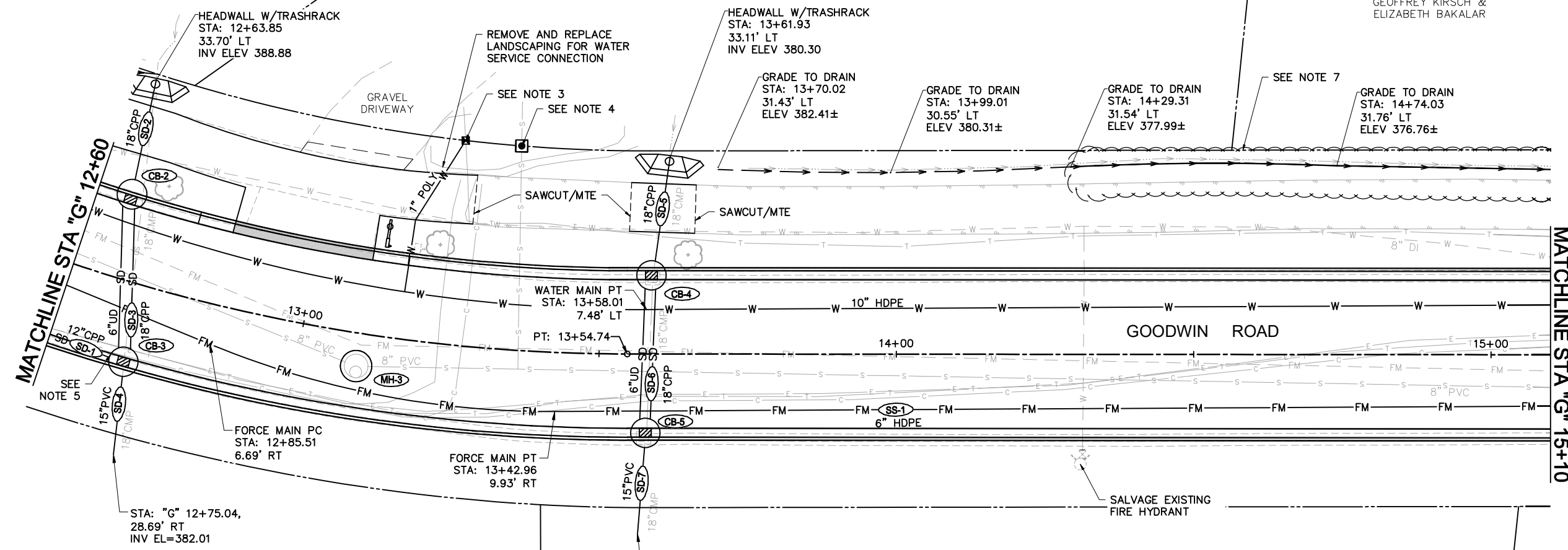

\\JUNU-FS\JUNU-Projects\22\71078-01\65CAD\Civil\SC20-12-18 12:34 SAVED DATE 2020-12-14 10:25 USER: csims

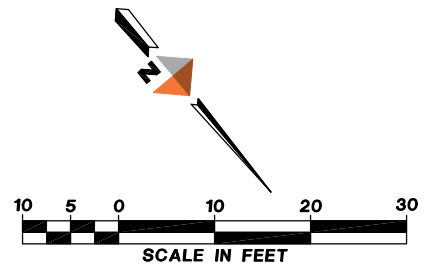

REVISIONS			
REV	DATE	DESCRIPTION	BY

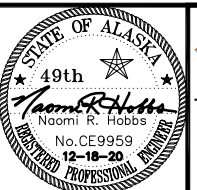

**DOWL**  
AECL848  
WWW.DOWL.COM  
9085 Glacier Highway  
Juneau, Alaska 99801  
907-780-3533



GOODWIN ROAD RECONSTRUCTION  
BE21-179  
PLAN - GOODWIN ROAD  
STA "G" 12+60 TO STA "G" 15+10

PROJECT	71078.01
DATE	12/18/2020
SHEET	11 OF 14



- NOTES:**
1. STORM DRAIN STRUCTURE STATION AND OFFSET IS GIVEN TO THE CENTER OF THE STRUCTURE. ALL FINISHED GRADES (FG) PROVIDED ARE TO THE FLOWLINE OF THE FRAME AT THE LONGITUDINAL CENTER OF THE FRAME AFTER APPLICATION OF THE LOCALIZED DEPRESSION.
  2. PIPE LENGTHS AND SLOPES SHOWN ARE CALCULATED TO ENDS OF PIPE. PAY LENGTHS ARE TO CENTER OF STRUCTURE.
  3. INSTALL NEW WATER SERVICE, SEE SUMMARY ON SHEET 04.
  4. INSTALL NEW SEWER SERVICE WITH CLEANOUT, SEE SUMMARY ON SHEET 04.
  5. REMOVE EXISTING ASPHALT, REPLACE WITH 3" OF TOPSOIL WITH SEEDING. GRADE TO DRAIN.
  6. SEE LIFT STATION CONNECTION DETAIL SHEET 6. WATERPROOF LIFT STATION VAULT WITH BITUMINOUS COATING AND INSTALL CORROSION PROTECTION ANODE. INSTALL 6" PVC DRAIN FROM INTERIOR OF VAULT TO HILLSIDE.
  7. INSTALL RIGID INSULATION ABOVE SS-2 WHERE COVER IS LESS THAN 3'-8" PER STD 412.
  8. BEGIN 1:1 BACKSLOPE ON DITCH. EXTEND TO HEADWALL.
  9. PROTECT AND MAINTAIN EXISTING MOUNTAIN ASH TREES.
  10. HAND CLEAR TREES OVERHANGING PATHWAY AS DIRECTED BY ENGINEER.

PIPE SUMMARY - STORM SEWER AND SANITARY SEWER				
PIPE	DIA	LENGTH	TYPE	SLOPE
SD-8	24"	30.5'	CPP	0.100
SD-9	24"	24.2'	CPP	0.020
SD-10	21"	40.2'	PVC	SLIPLINE
SS-2	8"	113.2'	PVC	0.004
SS-1			**SEE SHEET 10**	

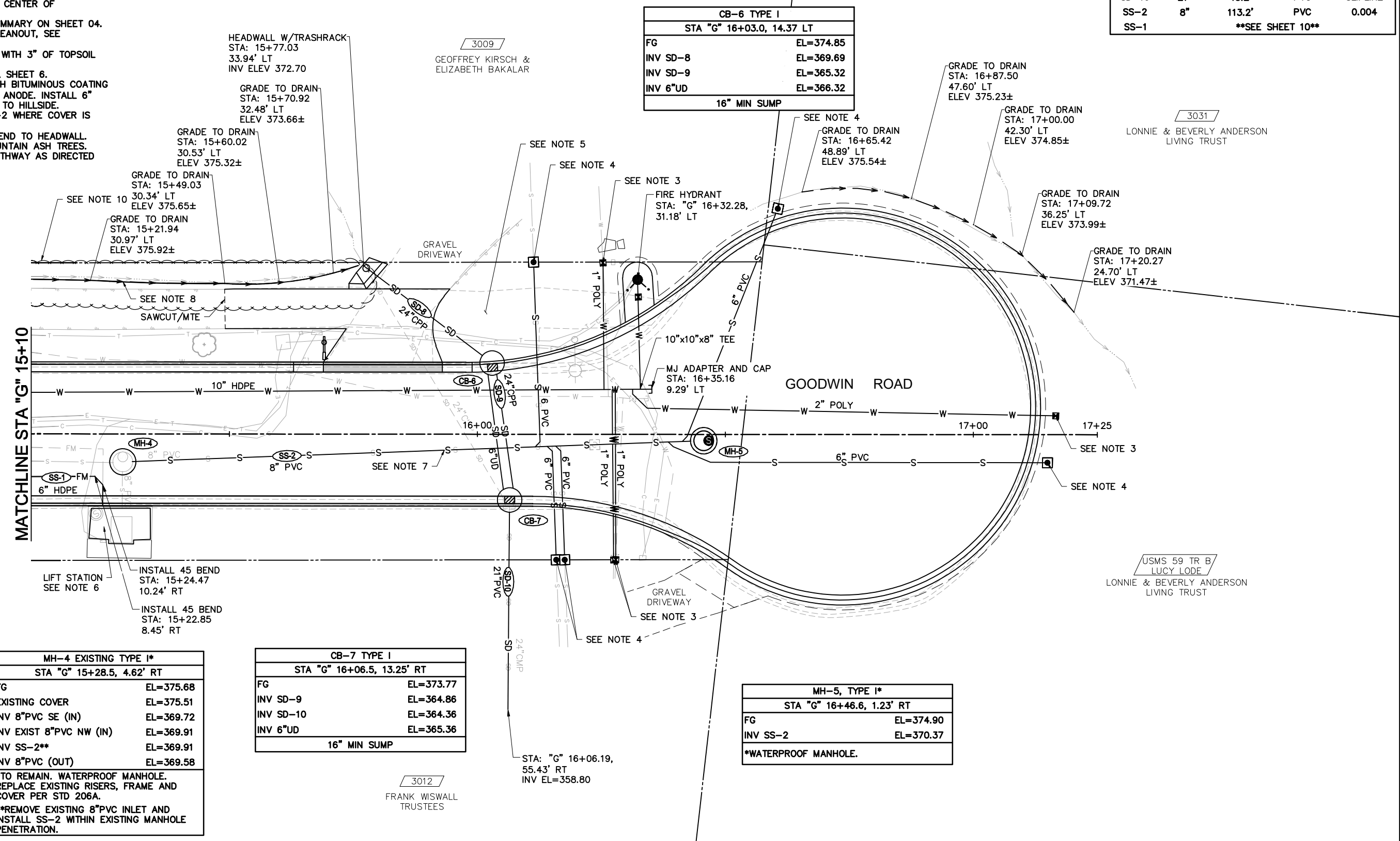

MH-4 EXISTING TYPE I*	
STA "G" 15+28.5, 4.62' RT	
FG	EL=375.68
EXISTING COVER	EL=375.51
INV 8" PVC SE (IN)	EL=369.72
INV EXIST 8" PVC NW (IN)	EL=369.91
INV SS-2**	EL=369.91
INV 8" PVC (OUT)	EL=369.58
*TO REMAIN. WATERPROOF MANHOLE. REPLACE EXISTING RISERS, FRAME AND COVER PER STD 206A.	
**REMOVE EXISTING 8" PVC INLET AND INSTALL SS-2 WITHIN EXISTING MANHOLE PENETRATION.	

CB-7 TYPE I	
STA "G" 16+06.5, 13.25' RT	
FG	EL=373.77
INV SD-9	EL=364.86
INV SD-10	EL=364.36
INV 6" UD	EL=365.36
16" MIN SUMP	

MH-5, TYPE I*	
STA "G" 16+46.6, 1.23' RT	
FG	EL=374.90
INV SS-2	EL=370.37
*WATERPROOF MANHOLE.	

CB-6 TYPE I	
STA "G" 16+03.0, 14.37 LT	
FG	EL=374.85
INV SD-8	EL=369.69
INV SD-9	EL=365.32
INV 6" UD	EL=366.32
16" MIN SUMP	

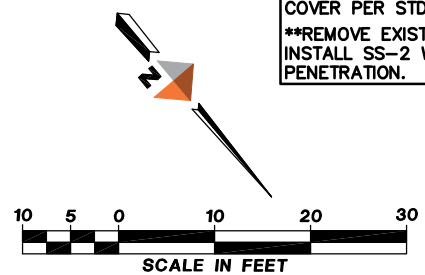

REVISIONS			
REV	DATE	DESCRIPTION	BY

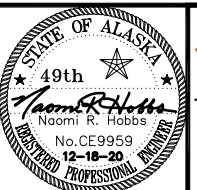

**DOWL**  
AECL848  
WWW.DOWL.COM  
9085 Glacier Highway  
Juneau, Alaska 99801  
907-780-3533



GOODWIN ROAD RECONSTRUCTION  
BE21-179  
PLAN - GOODWIN ROAD  
STA "G" 15+10 TO EOP

PROJECT	71078.01
DATE	12/18/2020
SHEET	12 OF 14

\\JUNU-FS\JUNU-Projects\22\71078-01\65CAD\Civil\SC20-CT-BA-71078.dwg PLOT DATE: 2020-12-18 12:34 SAVED DATE: 2020-12-14 10:25 USER: csims

\\JNU-FS\JNU-Projects\22\71078-01\65CAD\Civil\SC20-CT-PF-71078.dwg PLOT DATE 2020-12-18 12:49 SAVED DATE 2020-12-14 10:25 USER: csims

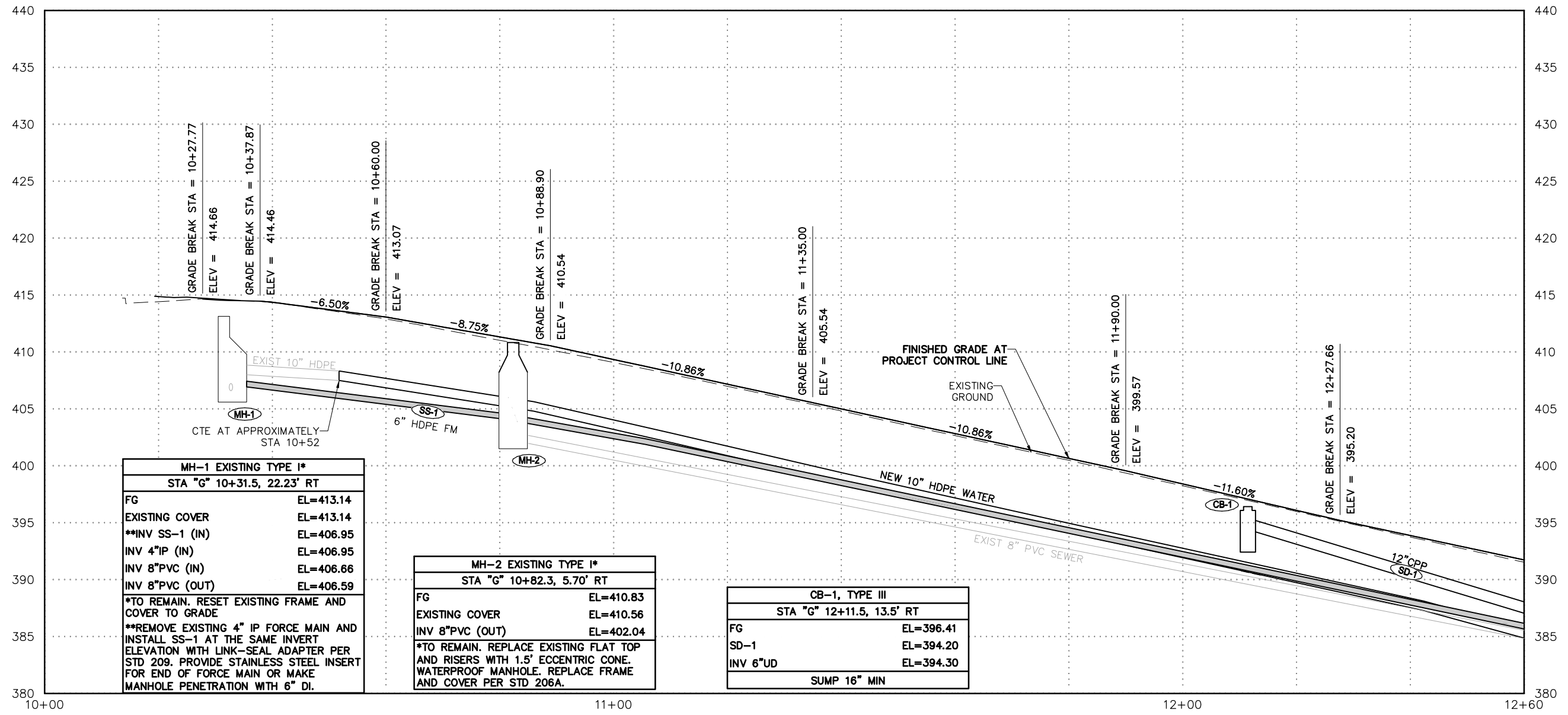

MH-1 EXISTING TYPE I*	
STA "G" 10+31.5, 22.23' RT	
FG	EL=413.14
EXISTING COVER	EL=413.14
**INV SS-1 (IN)	EL=406.95
INV 4"IP (IN)	EL=406.95
INV 8"PVC (IN)	EL=406.66
INV 8"PVC (OUT)	EL=406.59
*TO REMAIN. RESET EXISTING FRAME AND COVER TO GRADE	
**REMOVE EXISTING 4" IP FORCE MAIN AND INSTALL SS-1 AT THE SAME INVERT ELEVATION WITH LINK-SEAL ADAPTER PER STD 209. PROVIDE STAINLESS STEEL INSERT FOR END OF FORCE MAIN OR MAKE MANHOLE PENETRATION WITH 6" DI.	

MH-2 EXISTING TYPE I*	
STA "G" 10+82.3, 5.70' RT	
FG	EL=410.83
EXISTING COVER	EL=410.56
INV 8"PVC (OUT)	EL=402.04
*TO REMAIN. REPLACE EXISTING FLAT TOP AND RISERS WITH 1.5' ECCENTRIC CONE. WATERPROOF MANHOLE. REPLACE FRAME AND COVER PER STD 206A.	

CB-1, TYPE III	
STA "G" 12+11.5, 13.5' RT	
FG	EL=396.41
SD-1	EL=394.20
INV 6"UD	EL=394.30
SUMP 16" MIN	

BLUEBERRY HILLS ROAD TO STA "G" 12+60

- NOTES:**
- SERVICES AND 6" UNDERDRAINS NOT SHOWN FOR CLARITY.
  - LONGITUDINAL RUN OF UTILITIES NOT SHOWN FOR CLARITY.
  - HEADWALLS NOT SHOWN.
  - EXCEPT AT THE POINT OF CONNECTION, THE EXISTING WATER MAIN IS NOT SHOWN.

REVISIONS			
REV	DATE	DESCRIPTION	BY

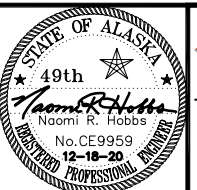

**DOWL**  
 AECL848  
 WWW.DOWL.COM  
 9085 Glacier Highway  
 Juneau, Alaska 99801  
 907-780-3533



GOODWIN ROAD RECONSTRUCTION  
 BE21-179  
 PROFILE - GOODWIN ROAD  
 BLUEBERRY HILLS RD TO STA "G" 12+60

PROJECT	71078.01
DATE	12/18/2020
SHEET	13 OF 14

\\JUNU-FS\JUNU-Projects\22\71078-01\65CAD\Civil\SC20-CT-PF-71078.dwg PLOT DATE: 2020-12-18 12:49 SAVED DATE: 2020-12-14 10:25 USER: csims

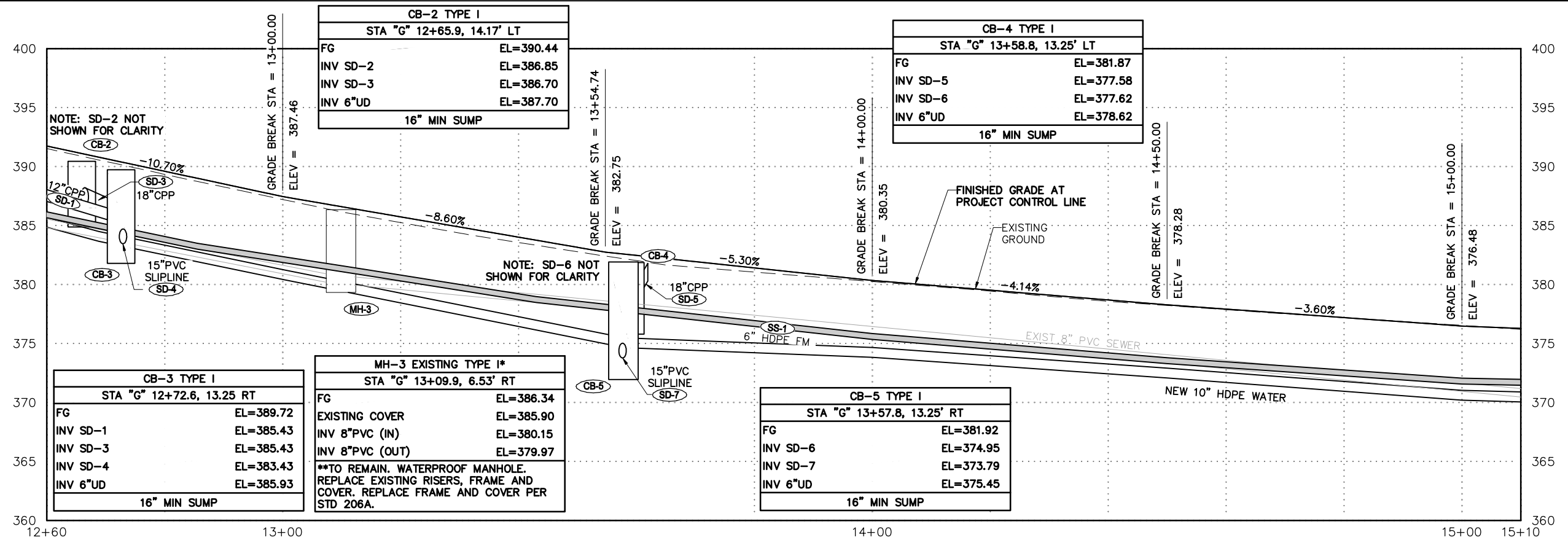

STA "G" 12+60 TO STA "G" 15+10

CB-6 TYPE I	
STA "G" 16+03.0, 14.37 LT	
FG	EL=374.85
INV SD-8	EL=369.69
INV SD-9	EL=365.32
INV 6"UD	EL=366.32
16" MIN SUMP	

MH-4 EXISTING TYPE I*	
STA "G" 15+28.5, 4.62' RT	
FG	EL=375.68
EXISTING COVER	EL=375.51
INV 8"PVC SE (IN)	EL=369.72
INV EXIST 8"PVC NW (IN)	EL=369.91
INV SS-2**	EL=369.91
INV 8"PVC (OUT)	EL=369.58
**TO REMAIN. WATERPROOF MANHOLE. REPLACE EXISTING RISERS, FRAME AND COVER. REPLACE FRAME AND COVER PER STD 206A.	
**REMOVE EXISTING 8"PVC INLET AND INSTALL SS-2 WITHIN EXISTING MANHOLE PENETRATION.	

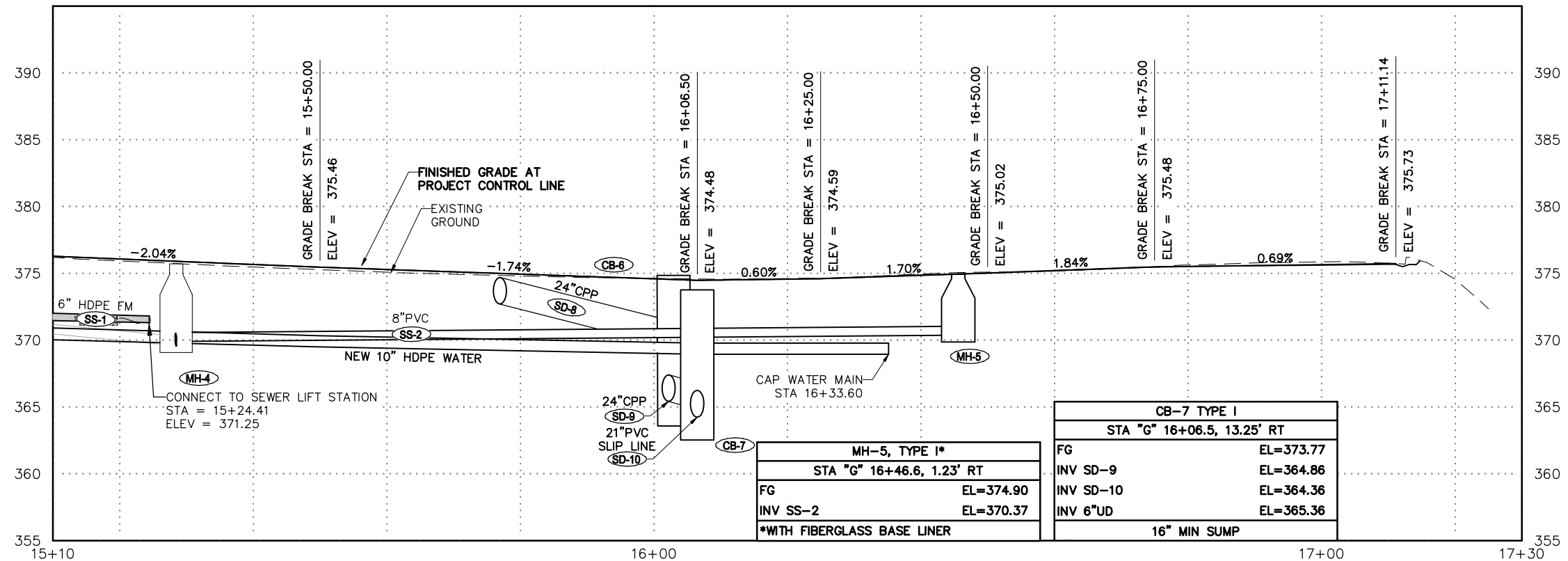

STA "G" 15+10 TO EOP

- NOTES:**
- SERVICES NOT SHOWN.
  - LONGITUDINAL RUN OF UTILITIES NOT SHOWN FOR CLARITY.
  - HEADWALLS NOT SHOWN.
  - EXCEPT AT THE POINT OF CONNECTION, THE EXISTING WATER MAIN IS NOT SHOWN.

REVISIONS			
REV	DATE	DESCRIPTION	BY

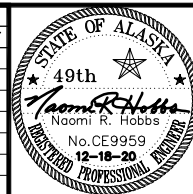

**DOWL**  
AECL848  
WWW.DOWL.COM  
9085 Glacier Highway  
Juneau, Alaska 99801  
907-780-3533



GOODWIN ROAD RECONSTRUCTION  
BE21-179

PROFILE - GOODWIN ROAD  
STA "G" 12+60 TO EOP

PROJECT	71078.01
DATE	12/18/2020
SHEET	
14 OF 14	