

CBJ DOUGLAS LIBRARY MEETING ROOM RENOVATION

Contract No. BE20-259

File No. 2070



SECTION 00005 - TABLE OF CONTENTS

DIVISION 0 - BIDDING AND CONTRACT REQUIREMENTS, CONTRACT FORMS, AND CONDITIONS OF THE CONTRACT

BIDDING and CONTRACT REQUIREMENTS **No. of Pages**

00005	Table of Contents	2
00030	Notice Inviting Bids	3
00100	Instructions to Bidders	9
00300	Bid	2
00310	Bid Schedule	1
00320	Bid Bond	1
00360	Subcontractor Report.....	2

CONTRACT FORMS

00500	Agreement	6
00610	Performance Bond	2
00620	Payment Bond	2

CONDITIONS OF THE CONTRACT

00700	General Conditions	45
00800	Supplementary General Conditions	4
00830	Alaska Labor Standards, Reporting, and Prevailing Wage Rate Determination	1
	Appendix A – Pamphlet 600 – Effective April 3, 2020.	38

TECHNICAL SPECIFICATIONS

DIVISION 1 - GENERAL REQUIREMENTS

011000	Summary	4
011230	Alternates.....	2
012500	Substitution Procedures.....	4
012600	Contract Modification Procedures.....	2
012900	Payment Procedures	3
013100	Project Management and Coordination.....	7
013200	Construction Progress Documentation.....	4
013300	Submittal Procedures.....	8
014000	Quality Requirements.....	6
014200	References	2
015000	Temporary Facilities and Controls	5
016000	Product Requirements	5
017300	Execution.....	6
017700	Closeout Requirements.....	10
017283	Operation and Maintenance Data	5
017839	Project record Documents	3

SECTION 00005 - TABLE OF CONTENTS

DIVISION 02 - EXISTING CONDITIONS

024119 Selective Demolition 5

DIVISION 06 - WOOD AND PLASTICS

064600 Wood Trim 2

DIVISION 09 - FINISHES

092900 Gypsum Board..... 3
095113 Acoustical Panel Ceilings..... 3
096513 Resilient Base & Accessories..... 4
096519 Resilient Tile Flooring..... 4
099123 Interior Painting..... 3

DRAWINGS

A001 Cover Sheet
A201 Main Floor – Overall Plan
AD101 Enlarged Demo Plan
A401 Enlarged Reno Plan
A601 Enlarged Reflected Ceiling Plan
A901 Interior Details

E201 Electrical Plans

END OF SECTION

SECTION 00030 - NOTICE INVITING BIDS

OBTAINING CONTRACT DOCUMENTS. The Contract Documents are entitled:

**CBJ Douglas Library Meeting Room Renovation
CBJ Contract No. BE20-259**

The Contract Documents may be downloaded from the CBJ Engineering Department webpage at: www.juneau.org/engineering

PRE-BID CONFERENCE. Prospective Bidders are encouraged to attend a Pre-Bid conference of the proposed WORK, which will be conducted by the OWNER and ARCHITECT, at 10:00 a.m. on July 8, 2020, via conference call. The object of the conference is to acquaint Bidders with the bid documents and site conditions. Bidders intending to participate shall email contracts@juneau.org by 4:30 p.m., July 7, 2020, to obtain to call-in instructions.

DESCRIPTION OF WORK. This Project consists of the following: replace wood flooring with vinyl flooring and base; replace acoustical ceiling panels; patch and repair wall surfaces; paint walls; minor electrical work and patching, and other Work indicated in the Contract Documents.

COMPLETION OF WORK. The WORK must be completed within 120 days of issuance of the Notice to Proceed.

DEADLINE FOR BIDDER QUESTIONS: July 15, 2020, at 4:30PM.

DEADLINE FOR BIDS: Sealed bids must be received by the Purchasing Division **prior to 2:00 p.m., Alaska Time on July 22, 2020,** or such later time as may be announced by addendum at any time prior to the deadline. Bids will be time and date stamped by the Purchasing Division, which will establish the official time of receipt of bids. Bids will be opened immediately thereafter. To attend the bid opening by telephone, bidders and interested members of the public can dial 907-713-2140 then enter the Participation ID Code 258358.

Bid documents delivered in person or by **courier** service must be delivered to:

Bid documents delivered by the **U.S. Postal Service** must be mailed to:

PHYSICAL LOCATION:
City and Borough of Juneau, Purchasing Division
105 Municipal Way, Room 300
Juneau, AK 99801

MAILING ADDRESS:
City and Borough of Juneau, Purchasing Division
155 South Seward Street
Juneau, AK 99801

SECTION 00030 - NOTICE INVITING BIDS

Please affix the label below to outer envelope in the lower left hand corner.

IMPORTANT NOTICE TO BIDDER		
To submit your Bid:		
1. Print your company name and address on the upper left corner of your envelope.		
2. Complete this label and place it on the lower left corner of your envelope.		
S E A L E D	BID NUMBER:	B I D
	<u>BE20-259</u>	
	SUBJECT:	
	<u>CBJ Douglas Library</u>	
	<u>Meeting Room Renovation</u>	
DEADLINE DATE:		
	<u>PRIOR TO 2:00PM ALASKA TIME</u>	

Mailing/delivery times to Alaska may take longer than other areas of the U.S. Late bids will not be accepted and will be returned.

SITE OF WORK. The site of the WORK is the CBJ Douglas Library at 1016 3rd Street, Douglas, Alaska.

BIDDING, CONTRACT, or TECHNICAL QUESTIONS. All communications relative to this WORK, prior to opening Bids, shall be directed to the following:

Greg Smith, Contract Administrator
CBJ Engineering Department, 3rd Floor, Marine View Center
greg.smith@juneau.org
Telephone: (907) 586-0873
Fax: (907) 586-4530

BID SECURITY. Each Bid shall be accompanied by a certified or cashier's check or Bid Bond, in the amount of 5% percent of the Bid, payable to the City and Borough of Juneau, Alaska, as a guarantee that the Bidder, if its Bid is accepted, will promptly execute the Agreement. A Bid shall not be considered unless one of the forms of Bidder's security is enclosed with it.

CONTRACTOR'S LICENSE. All contractors are required to have a current Alaska Contractor's License, prior to submitting a Bid, and a current Alaska Business License prior to award.

BID TO REMAIN OPEN. The Bidder shall guarantee the Bid for a period of 120 Days from the date of Bid opening. Any component of the Bid, including Additive Alternates, may be awarded anytime during the 120 Days.

OWNER'S RIGHTS RESERVED. The OWNER reserves the right to reject any or all Bids, to waive any informality in a Bid, and to make award to the lowest responsive, responsible Bidder as it may best serve the interests of the OWNER.

SECTION 00030 - NOTICE INVITING BIDS

OWNER: City and Borough of Juneau

By: 
for Greg Smith, Contract Administrator

6-30-20
Date

END OF SECTION

SECTION 00100 - INSTRUCTIONS TO BIDDERS

1.0 DEFINED TERMS. Terms used in these Instructions to Bidders and the Notice Inviting Bids, which are defined in the General Conditions, have the meanings assigned to them in the General Conditions. The term "Bidder" means one who submits a Bid directly to the OWNER, as distinct from a sub-bidder, who submits a Bid to a Bidder.

2.0 INTERPRETATIONS AND ADDENDA.

- A. **INTERPRETATIONS.** All questions about the meaning or intent of the Contract Documents are to be directed to the Engineering Contracts Administrator. Interpretations or clarifications considered necessary by the Engineering Contracts Administrator in response to such questions will be issued by Addendum, mailed, faxed, or delivered to all parties recorded by the Engineering Contracts Administrator, or OWNER, as having received the Contract Documents. Questions received less than seven Days prior to the Deadline for Bids may not be answered. Only questions answered by formal written Addendum will be binding. Oral and other interpretations or clarifications will be without legal effect.
- B. **ADDENDA.** Addenda may be issued to modify the Contract Documents as deemed advisable by the OWNER. Addenda may be faxed or, if addendum format warrants, addenda may be posted to the CBJ Engineering Department website. In any event, notification of addendum issuance will be faxed to planholders. Hard copies are available upon request. The OWNER will make all reasonable attempts to ensure that all planholders receive notification of Addenda, however, it is strongly recommended by the OWNER that bidders independently confirm the contents, number, and dates of each Addendum prior to submitting a Bid.

3.0 FAIR COMPETITION. More than one Bid from an individual, firm, partnership, corporation, or association under the same or different names will not be considered. If the OWNER believes that any Bidder is interested in more than one Bid for the WORK contemplated, all Bids in which such Bidder is interested will be rejected. If the OWNER believes that collusion exists among the Bidders, all Bids will be rejected.

4.0 RESPONSIBILITY OF BIDDERS. Only responsive Bids from responsible Bidders will be considered. A Bid submitted by a Bidder determined to be not responsible may be rejected. The OWNER may find a bidder to be not responsible for any one of the following reasons, but is not limited in its responsibility analysis to the following factors:

- A. Evidence of bid rigging or collusion;
- B. Fraud or dishonesty in the performance of previous contracts;
- C. Record of integrity;
- D. More than one bid for the same work from an individual, firm, or corporation under the same or different name;
- E. Unsatisfactory performance on previous or current contracts;
- F. Failure to pay, or satisfactorily settle, all bills due for labor and material on previous contracts;

SECTION 00100 - INSTRUCTIONS TO BIDDERS

- G. Uncompleted work that, in the judgment of the OWNER, might hinder or prevent the bidder's prompt completion of additional work, if awarded;
- H. Failure to reimburse the OWNER for monies owed on any previous contracts;
- I. Default under previous contracts;
- J. Failure to comply with any qualification requirements of the OWNER; special standards for responsibility, if applicable, will be specified. These special standards establish minimum standards or experience required for a responsible Bidder on a specific contract;
- K. Engaging in any activity that constitutes a cause for debarment or suspension under the CBJ Procurement Code 53.50 or submitting a bid during a period of debarment;
- L. Lack of skill, ability, financial resources, or equipment required to perform the contract; or
- M. Lack of legal capacity to contract.
- N. Bidders must be registered as required by law and in good standing for all amounts owned to the OWNER per Paragraph 21.0 of this Section.
- O. Failure to submit all completed documents as required and specified on the Bid Form, Section 00300.

Nothing contained in this section deprives the OWNER of its discretion in determining the lowest responsible bidder. Before a Bid is considered for award, a Bidder may be requested to submit information documenting its ability and competency to perform the WORK, according to general standards of responsibility and any special standards which may apply. It is Bidder's responsibility to submit sufficient, relevant, and adequate information. OWNER will make its determination of responsibility and has no obligation to request clarification or supplementary information.

5.0 NON-RESPONSIVE BIDS. Only responsive Bids will be considered. Bids may be considered non-responsive and may be rejected. Some of the reasons a Bid may be rejected for being non-responsive are:

- A. If a Bid is received by the CBJ Purchasing Division after the Deadline for Bids.
- B. If the Bid is on a form other than that furnished by the OWNER, or legible copies thereof; or if the form is altered or any part thereof is detached; or if the Bid is improperly signed.
- C. If there are unauthorized additions, conditional or alternate Bids, or irregularities of any kind which may tend to make the bid incomplete, indefinite, ambiguous as to its meaning, or in conflict with the OWNER's Bid document.
- D. If the Bidder adds any unauthorized conditions, limitations, or provisions reserving the right to accept or reject any award, or to enter into a contract pursuant to an award. This does not exclude a Bid limiting the maximum gross amount of awards acceptable to any one Bidder at any one Bid opening, provided that any selection of awards will be made by the OWNER.
- E. If the Bid does not contain a Unit Price for each pay item listed, except in the case of

SECTION 00100 - INSTRUCTIONS TO BIDDERS

authorized alternate pay items.

- F. If the Bidder has not acknowledged receipt of each Addendum.
- G. If the Bidder fails to furnish an acceptable Bid guaranty with the Bid.
- H. If any of the Unit Prices Bid are excessively unbalanced (either above or below the amount of a reasonable Bid) to the potential detriment of the OWNER.
- I. If a Bid modification does not conform to Article 15.0 of this Section.

6.0 BIDDER'S EXAMINATION OF CONTRACT DOCUMENTS AND SITE. It is the responsibility of each Bidder before submitting a Bid:

- A. To examine thoroughly the Contract Documents, and other related data identified in the Bidding documents (including "technical data" referred to below):
 - 1. To visit the site to become familiar with and to satisfy the Bidder as to the general and local conditions that may affect cost, progress, or performance, of the WORK,
 - 2. To consider federal, state and local laws and regulations that may affect cost, progress, or performance of the WORK,
 - 3. To study and carefully correlate the Bidder's observations with the Contract Documents, and other related data; and
 - 4. To notify the ARCHITECT of all conflicts, errors, or discrepancies in or between the Contract Documents and such other related data.

7.0 REFERENCE IS MADE TO THE SUPPLEMENTARY GENERAL CONDITIONS FOR IDENTIFICATION OF:

- A. Those reports of explorations and tests of subsurface conditions at the site which have been utilized by the Architect of Record in the preparation of the Contract Documents. The Bidder may rely upon the accuracy of the technical data contained in such reports, however, the interpretation of such technical data, including any interpolation or extrapolation thereof, together with non-technical data, interpretations, and opinions contained therein or the completeness thereof is the responsibility of the Bidder.
- B. Those Drawings of physical conditions in or relating to existing surface and subsurface conditions (except underground utilities) which are at or contiguous to the site have been utilized by the Architect of Record in the preparation of the Contract Documents. The Bidder may rely upon the accuracy of the technical data contained in such Drawings, however, the interpretation of such technical data, including any interpolation or extrapolation thereof, together with nontechnical data, interpretations, and opinions contained in such Drawings or the completeness thereof is the responsibility of the Bidder.
- C. Copies of such reports and Drawings will be made available by the OWNER to any Bidder on request if said reports and Drawings are not bound herein. Those reports and Drawings are not part of the Contract Documents, but the technical data contained therein upon which the Bidder is entitled to rely, as provided in Paragraph SGC-4.2 of the Supplementary General Conditions, are incorporated herein by reference.
- D. Information and data reflected in the Contract Documents with respect to underground

SECTION 00100 - INSTRUCTIONS TO BIDDERS

utilities at or contiguous to the site is based upon information and data furnished to the OWNER and the Architect of Record by the owners of such underground utilities or others, and the OWNER does not assume responsibility for the accuracy or completeness thereof unless it is expressly provided otherwise in the Supplementary General Conditions, or in Section 01530 - Protection and Restoration of Existing Facilities of the General Requirements.

- E. Provisions concerning responsibilities for the adequacy of data furnished to prospective Bidders on subsurface conditions, underground utilities and other physical conditions, and possible changes in the Contract Documents due to differing conditions appear in Paragraphs 4.2, 4.3, and 4.4 of the General Conditions.
- F. Before submitting a Bid, each Bidder will, at Bidder's own expense, make or obtain any additional examinations, investigations, explorations, tests, and studies and obtain any additional information and data which pertain to the physical conditions (surface, subsurface, and underground utilities) at or contiguous to the site or otherwise which may affect cost, progress, or performance of the WORK and which the Bidder deems necessary to determine its Bid for performing the WORK in accordance with the time, price, and other terms and conditions of the Contract Documents.
- G. On request in advance, the OWNER will provide each Bidder access to the site to conduct such explorations and tests as each Bidder deems necessary for submission of a Bid. Bidder shall fill all holes and shall clean up and restore the site to its former condition upon completion of such explorations.
- H. The lands upon which the WORK is to be performed, rights-of-way and easements for access thereto and other lands designated for use by the CONTRACTOR in performing the WORK are identified in the Contract Documents. All additional lands and access thereto required for temporary construction facilities or storage of materials and equipment are to be provided by the CONTRACTOR. Easements for permanent structures or permanent changes in existing structures are to be obtained and paid for by the OWNER unless otherwise provided in the Contract Documents.
- I. The submission of a Bid will constitute an incontrovertible representation by the Bidder that the Bidder has complied with every requirement of Article 6.0, "Bidder's Examination of Contract Documents and Site" herein, that without exception the Bid is premised upon performing the WORK required by the Contract Documents and such means, methods, techniques, sequences, or procedures of construction as may be indicated in or required by the Contract Documents, and that the Contract Documents are sufficient in scope and detail to indicate and convey understanding of all terms and conditions for performance of the WORK.

8.0 BID FORM.

- A. The Bid shall be made on the Bid Schedule(s) bound herein, or on the yellow Bid packet provided, or on legible and complete copies thereof, and shall contain the following: Sections 00300, 00310, the required Bid Security, and any other documents required in Section 00300 – Bid.
- B. All blanks on the Bid Form and Bid Schedule must be completed in ink or typed.

SECTION 00100 - INSTRUCTIONS TO BIDDERS

- C. Bids by corporations must be executed in the corporate name by the president, a vice-president (or other corporate officer). The corporate address and state of incorporation must appear below the signature.
- D. Bids by partnerships must be executed in the partnership name and be signed by a managing partner, and the official address of the partnership must appear below the signature.
- E. The Bidder's Bid must be signed. All names must be printed or typed below the signature.
- F. The Bid shall contain an acknowledgment of receipt of all Addenda, the numbers of which shall be filled in on the Bid form. Failure to acknowledge Addenda may render Bid non-responsive and may cause its rejection.
- G. The address to which communications regarding the Bid are to be directed must be shown.

9.0 QUANTITIES OF WORK. The quantities of WORK, or material, stated in Unit Price items of the Bid are supplied only to give an indication of the general scope of the WORK; the OWNER does not expressly or by implication agree that the actual amount of WORK, or material, will correspond therewith, and reserves the right after award to increase or decrease the amount of any Unit Price item of the WORK by an amount up to and including 25 percent of any Bid item, without a change in the Unit Price, and shall include the right to delete any Bid item in its entirety, or to add additional Bid items up to and including an aggregate total amount not to exceed 25 percent of the Contract Price (see Section 00700 - General Conditions, Article 10 Changes In the WORK).

10.0 SUBSTITUTE OR "OR-EQUAL" ITEMS. Substitution requests are not accepted during the bidding process. The procedure for the submittal of substitute or "or-equal" products is specified in Section 013300 – Contractor Submittals.

11.0 SUBMISSION OF BIDS. The Bid shall be delivered by the time and to the place stipulated in Section 00030 - Notice Inviting Bids. It is the Bidder's sole responsibility to see that its Bid is received in proper time. Oral, telegraphic, emailed, or faxed Bids will not be considered. The envelope enclosing the sealed Bids shall be plainly marked in the upper left-hand corner with the name and address of the Bidder and shall also include the label included in Section 00030 – Notice Inviting Bids. The Bid Security shall be enclosed in the same envelope with the Bid

12.0 BID SECURITY, BONDS, AND INSURANCE. Each Bid shall be accompanied by a certified, or cashier's check, or approved Bid Bond in an amount of at least 5 percent of the total Bid price. The "total Bid price" is the amount of the Base Bid, plus the amount of alternate Bids, if any, which total to the maximum amount for which the CONTRACT could be awarded. Said check or Bond shall be made payable to the OWNER and shall be given as a guarantee that the Bidder, if offered the WORK, will enter into an Agreement with the OWNER, and will furnish the necessary insurance certificates, Payment Bond, and Performance Bond; each of said Bonds, if required, and insurance amounts shall be as stated in the Supplementary General Conditions. In case of refusal or failure to enter into said Agreement, the check or Bid Bond, as the case may be, may be forfeited to the OWNER. If the Bidder elects to furnish a Bid Bond as its Bid security, the Bidder shall use the Bid Bond form bound herein, or one conforming substantially to it in form. Bid Bonds must be accompanied by a legible Power of Attorney.

SECTION 00100 - INSTRUCTIONS TO BIDDERS

13.0 RETURN OF BID SECURITY. The OWNER will return all Bid security checks (certified or cashier's) accompanying such of the Bids as are not considered in making the award. All other Bid securities will be held until the Agreement has been executed. Following execution of the Agreement, all other Bid security checks will be returned to the respective Bidders whose Bids they accompanied and Bid security bonds will be appropriately discarded.

14.0 DISCREPANCIES IN BIDS. In the event there is more than one Pay Item in a Bid Schedule, the Bidder shall furnish a price for all Pay Items in the schedule, and failure to do so may render the Bid non-responsive and cause its rejection. In the event there are Unit Price Pay Items in a Bid Schedule and the "amount" indicated for a Unit Price Bid Item does not equal the product of the Unit Price and quantity, the Unit Price shall govern and the amount will be corrected accordingly, and the Bidder shall be bound by said correction. In the event there is more than one Pay Item in a Bid Schedule and the total indicated for the schedule does not agree with the sum of the prices Bid on the individual items, the prices Bid on the individual items shall govern and the total for the schedule will be corrected accordingly, and the Bidder shall be bound by said correction.

15.0 BID MODIFICATIONS AND UNAUTHORIZED ALTERNATIVE BIDS.

- A. Any bidder may deliver a modification to a bid in person, by mail or fax (907-586-4561), provided that such modification is received by the Purchasing Division no later than the deadline for bids. Modifications will be time and date stamped by the Purchasing Division, which will establish the official time of receipt of the modification. The modification must not reveal the bid price but should be in the form of an addition or subtraction or other modification so that the final prices will not be known until the sealed bid is opened.

The Bid modifications shall be provided on the **Bid Modification Form** located at the end of this Section. Submittal of any other form by the vendor may deem the modification unacceptable by the OWNER. **A mail or fax modification should not reveal the Bid price but should provide the addition or subtraction or other modification so that the final prices will not be known by the City and Borough until the sealed Bid is opened.** Submitted Modification forms shall include the modification to the unit price or lump sum amount of each pay item modified.

FAX DISCLAIMER: It is the responsibility of the bidder to submit modifications in a timely manner. Bidders' use of a fax machine to modify their bid shall be at bidders' sole risk. The Purchasing Division will attempt to keep the fax machine in good working order but will not be responsible for bid modifications that are late due to mechanical failure, a busy fax machine, or any other cause arising from bidder's use of a fax machine, even if bidder submits a transmission report or provides other confirmation indicating that the bidder transmitted a bid modification prior to the deadline. The City will not be responsible for its failure to receive the modification whether such failure is caused by equipment or human error, or otherwise. Bidders are therefore strongly encouraged to confirm receipt of their bid modification with the Purchasing Division (907-586-5258) prior to deadline.

- B. Conditioned bids, limitations, or provisos attached to the Bid or bid modification will render it unauthorized and cause its rejection as being non-responsive. The completed Bid forms shall be without interlineations, alterations, or erasures in the printed text. All changes shall be initialed by the person signing the Bid. Alternative Bids will not be considered unless called for.

SECTION 00100 - INSTRUCTIONS TO BIDDERS

16.0 WITHDRAWAL OF BID. Prior to the Deadline for Bids, the Bid may be withdrawn by the Bidder by means of a written request, signed by the Bidder or its properly authorized representative. Such written request must be delivered to the place stipulated in the Notice Inviting Bids for receipt of Bids.

17.0 AWARD OF CONTRACT.

- A. Award of a contract, if it is awarded, will be on the basis of materials and equipment described in the Drawings or specified in the Technical Specifications and will be made to the lowest responsive, responsible Bidder whose Bid complies with all the requirements prescribed. Unless otherwise specified, any such award will be made within the period stated in the Notice Inviting Bids that the Bids are to remain open. Unless otherwise indicated, a single award will be made for all the Bid items in an individual Bid Schedule.
- B. If the OWNER has elected to advertise this Project with a Base Bid and Alternates, the OWNER may elect to award the contract for the Base Bid, or the Base Bid in combination with one or more Alternates selected by the OWNER. In either case, award shall be made to the responsive, responsible bidder offering the lowest total Bid for the WORK to be awarded.
- C. Low Bidder will be determined on the basis of the lowest total of the Base Bid plus combinations of Alternates if funding allows, as selected by the Selection Committee through the process described below.
 - 1 Prior to the Deadline for Bids, a Selection Committee will be appointed by the Owner.
 - 2 The Selection Committee will be sequestered in a conference room apart from the bid opening room at the time of bid opening.
 - 3 The CBJ Purchasing staff will open bids. A bid summary sheet will be compiled without bidder identification, so that the Selection Committee will have no knowledge of which bids were made by which bidders.
 - 4 The bid summary sheet will be delivered to the Selection Committee by the Engineering Contract Administrator.
 - 5 The Selection Committee will choose the low bid comprised of the Base Bid and those Alternates deemed to be in the best interest of the project and within the approved construction budget. For award purposes, the CBJ will add any Alternate to the Total Base Bid Amount in Section 00310 – Bid Schedule.
 - 6 The Selection Committee will identify in order from low to high the bids received for the project and the results will be posted.

18.0 EXECUTION OF AGREEMENT.

- A. All Bids of value greater than \$1,000,000 must be approved by the CBJ Assembly. After the CBJ Assembly has approved the award and after the Bid protest period, the OWNER will issue a Notice of Intent to Award to the approved Bidder. The Bidder to whom award is made shall execute a written Agreement with the OWNER on the Agreement form, Section 00500, collect insurance, and shall furnish all certificates and Bonds required by the Contract Documents within 10 Days (calendar) from the date of the Notice of Intent to Award letter.

SECTION 00100 - INSTRUCTIONS TO BIDDERS

- B. Failure or refusal to enter into the Agreement as herein provided or to conform to any of the stipulated requirements in connection therewith shall be just cause for annulment of the award and forfeiture of the Bid security. If the lowest responsive, responsible Bidder refuses or fails to execute the Agreement, the OWNER may award the contract to the second lowest responsive, responsible Bidder. If the second lowest responsive, responsible Bidder refuses or fails to execute the Agreement, the OWNER may award the contract to the third lowest responsive, responsible Bidder. On the failure or refusal of such second or third lowest Bidder to execute the Agreement, each such Bidder's Bid securities shall be likewise forfeited to the OWNER.

19.0 LIQUIDATED DAMAGES. Provisions for liquidated damages if any, are set forth in Section 00500 - Agreement.

20.0 FILING A PROTEST.

- A. A Bidder may protest the proposed award of a competitive sealed Bid by the City and Borough of Juneau. The protest shall be executed in accordance with CBJ Ordinance 53.50.062 PROTESTS and CBJ Ordinance 53.50.080 ADMINISTRATION OF PROTEST. The entire text of the CBJ Purchasing Ordinance can be accessed at the CBJ website, <http://www.juneau.org/law/code/code.php>, or call the CBJ Purchasing Division at (907) 586-5258 for a copy of the ordinance.
- B. Late protests shall not be considered by the CBJ Purchasing Officer.

21.0 CONTRACTOR'S GOOD STANDING WITH CBJ FINANCE DEPARTMENT: Contractors must be in good standing with the CBJ prior to award, and prior to any contract renewals, and in any event no later than *seven business days* following notification by the CBJ of intent to award as indicated in the Posting Notice of Bids. **Good standing** means: all amounts owed to the CBJ are current and the Contractor is not delinquent with respect to any taxes, fees, assessment, or other monies due and owed the CBJ, or a Confession of Judgment has been executed and the Contractor is in compliance with the terms of any stipulation associated with the Confession of Judgment, including being current as to any installment payments due; and Contractor is current in all CBJ reporting obligations (such as sales tax registration and reporting and business personal property declarations). Failure to meet these requirements may be cause for rejection of your bid. To determine if your business is in good standing, or for further information, contact the CBJ Finance Department's Sales Tax Division at (907) 586-5265 for sales tax issues, Assessor's Office at (907)586-0930 for business personal property issues, or Collections Division at (907) 586-5268 for all other accounts.

22.0 PERMITS AND LICENSES. The CONTRACTOR is responsible for all WORK associated with meeting any local, state, and/or federal permit and licensing requirements.

SECTION 00100 - INSTRUCTIONS TO BIDDERS

CITY AND BOROUGH OF JUNEAU
PURCHASING DIVISION
FAX NO. 907-586-4561

BID MODIFICATION FORM

Modification Number: _____

Note: All modifications shall be made to the original bid amount(s). If more than one Modification form is submitted by any one bidder, changes from all Modification forms submitted will be combined and applied to the original bid. Changes to the modified Bid amounts will be calculated by the OWNER.

PAY ITEM DESCRIPTION	MODIFICATION TO LUMP SUM (indicate +/-)
Base Bid	

Base Bid Total Increase or Decrease: \$ _____

ALTERNATE PAY ITEM DESCRIPTION	MODIFICATION TO LUMP SUM (indicate +/-)
Additive Alternate No. 1	

Alternate Total Increase or Decrease: \$ _____

Name of Bidding Firm

Responsible Party Signature

Printed Name (must be an authorized signatory for Bidding Firm)

END OF SECTION

SECTION 00300 - BID

BID TO: THE CITY AND BOROUGH OF JUNEAU

1. The undersigned Bidder proposes and agrees, if this Bid is accepted, to enter into an Agreement with the OWNER in the form included in the Contract Documents (as defined in Article 7 of Section 00500 - Agreement) to perform the WORK as specified or indicated in said Contract Documents entitled

**CBJ Douglas Library Meeting Room Renovation
CBJ Contract No. BE20-259**

2. Bidder accepts all of the terms and conditions of the Contract Documents, including without limitation those in the "Notice Inviting Bids" and "Instructions to Bidders," dealing with the disposition of the Bid Security.

3. This Bid will remain open for the period of time stated in the "Notice Inviting Bids" unless otherwise required by law. Bidder will enter into an Agreement within the time and in the manner required in the "Notice Inviting Bids" and the "Instructions to Bidders," and will furnish insurance certificates, Payment Bond, Performance Bond, and any other documents as may be required by the Contract Documents.

4. Bidder has familiarized itself with the nature and extent of the Contract Documents, WORK, site, locality where the WORK is to be performed, the legal requirements (federal, state and local laws, ordinances, rules, and regulations), and the conditions affecting cost, progress or performance of the WORK and has made such independent investigations as Bidder deems necessary.

5. This Bid is genuine and not made in the interest of or on behalf of any undisclosed person, firm or corporation and is not submitted in conformity with any agreement or rules of any group, association, organization or corporation; Bidder has not directly or indirectly induced or solicited any other Bidder to submit a false or sham Bid; Bidder has not solicited or induced any person, firm or corporation to refrain from bidding; and Bidder has not sought by collusion to obtain for itself any advantage over any other Bidder or over OWNER.

6. To all the foregoing, and including all Bid Schedule and information required of Bidder contained in this Bid Form, said Bidder further agrees to complete the WORK required under the Contract Documents within the Contract Time stipulated in said Contract Documents, and to accept in full payment therefore the Contract Price based on the total bid price(s) named in the aforementioned Bid Schedule.

7. Bidder has examined copies of all the Contract Documents including the following Addenda (receipt of all of which is hereby acknowledged by the Undersigned):

Addenda No.	Date Issued	Addenda No.	Date Issued

Give number and date of each addenda above. Failure to acknowledge receipt of all Addenda may cause the Bid to be non-responsive and may cause its rejection.

SECTION 00300 - BID

8. The Bidder has read this Bid and agrees to the conditions as stated herein by signing his/her signature in the space provided below.

Dated: _____	Bidder: _____ (Company Name)
Alaska CONTRACTOR's Business License No: _____	By: _____ (Signature)
Alaska CONTRACTOR's License No: _____	Printed Name: _____ Title: _____
Telephone No: _____	Address: _____ (Street or P.O. Box)
Fax No: _____	_____ (City, State, Zip)
Email: _____	

9. **TO BE CONSIDERED, ALL BIDDERS MUST COMPLETE AND INCLUDE THE FOLLOWING AT THE TIME OF THE DEADLINE FOR BIDS. MISSING DOCUMENTS WILL DEEM THIS BID NON-RESPONSIVE:**

- Bid, Section 00300 (includes addenda receipt statement)
- Completed Bid Schedule, Section 00310
- Bid Security (Bid Bond, Section 00320, or by a certified or cashier's check as stipulated in the Notice Inviting Bids, Section 00030)
- **Contractor Financial Responsibility, Section 00370**

10. The apparent low Bidder is required to complete and submit the following documents by 4:30 p.m. on the ***fifth business day*** following the date of the Posting Notice.

- Subcontractor Report, Section 00360

The apparent low Bidder who fails to submit the completed Subcontractor Report within the time specified in Section 00360 – Subcontractor Report, may be found to be not a responsible Bidder and may be required to forfeit the Bid security. The OWNER may then consider the next lowest Bidder for award of the contract.

11. The successful Bidder will be required to submit, within ***ten Days (calendar)*** after the date of the “Notice of Intent to Award” letter, the following executed documents:

- Agreement Forms, Section 00500
- Performance Bond, Section 00610
- Payment Bond, Section 00620
- Certificates of Insurance, (CONTRACTOR) Section 00700 and Section 00800

END OF SECTION

SECTION 00310 - BID SCHEDULE

Bid Schedule for construction of **BE20-259 CBJ Douglas Library Meeting Room Renovation**, in accordance with the Contract Documents.

BASE BID - Furnish all labor, equipment and materials to replace wood flooring with vinyl flooring and base; replace acoustical ceiling panels; patch and repair wall surfaces; paint walls; minor electrical work and patching, and perform all WORK as described in these Contract Documents.

TOTAL BASE BID \$ _____
(Price in Figures)

ADDITIVE ALTERNATE NO. 1 - Furnish all labor, equipment and materials and perform all WORK to remove ceiling grid and dividing wall ceiling track. Provide new ceiling grid.

TOTAL ADDITIVE ALTERNATE NO. 1 \$ _____
(Price in Figures)

Date: _____ **Bidder:** _____
(Company Name)

END OF SECTION

SECTION 00320 - BID BOND

KNOW ALL PERSONS BY THESE PRESENTS, that _____
_____ as Principal, and _____
as Surety, are held and firmly bound unto **THE CITY AND BOROUGH OF JUNEAU** hereinafter called
"OWNER," in the sum of _____
_____ dollars, (not less than five percent of the total amount of the Bid) for
the payment of which sum, well and truly to be made, we bind ourselves, our heirs, executors, administrators,
successors, and assigns, jointly and severally, firmly by these presents.

WHEREAS, said Principal has submitted a Bid to said OWNER to perform the WORK required
under the Bid Schedule of the OWNER's Contract Documents entitled

CBJ Douglas Library Meeting Room Renovation

CBJ Contract No. BE20-259

NOW THEREFORE, if said Principal is awarded a contract by said OWNER and, within the time and
in the manner required in the "Notice Inviting Bids" and the "Instructions to Bidders" enters into a written
Agreement on the form of Agreement bound with said Contract Documents, furnishes the required certificates
of insurance, and furnishes the required Performance Bond and Payment Bond, then this obligation shall be
null and void, otherwise it shall remain in full force and effect. In the event suit is brought upon this bond by
said OWNER and OWNER prevails, said Surety shall pay all costs incurred by said OWNER in such suit,
including a reasonable attorney's fee to be fixed by the court.

SIGNED AND SEALED, this _____ day of _____, 20_____.

(SEAL) _____
(Principal)

(SEAL) _____
(Surety)

By: _____
(Signature)

By: _____
(Signature)

END OF SECTION

SECTION 00360 - SUBCONTRACTOR REPORT

LIST OF SUBCONTRACTORS (AS 36.30.115)

The apparent low Bidder must submit a list of Subcontractors that the Bidder proposes to use in the performance of this contract *on the fifth business day* following the Posting Notice of Bids. If the fifth day falls on a weekend or holiday, the report is due by close of business on the next business Day following the weekend or holiday. The Subcontractor Report list must include each Subcontractor's name, address, location, evidence of valid Alaska Business License, and valid Alaska Contractor's Registration under AS 08.18. *If no Subcontractors are to be utilized in the performance of the WORK, write in ink or type "NONE" on line (1) below*

<u>SUBCONTRACTOR</u>	¹ AK Contractor License No.	¹ Contact Name	Type of	Contract	✓ if
<u>ADDRESS</u>	² AK Business License No.	² Phone No.	<u>Work</u>	<u>Amount</u>	<u>DBE</u>
1. _____ _____ _____	1 _____ 2 _____	_____ _____	_____ _____	\$ _____	<input type="checkbox"/>
2. _____ _____ _____	1 _____ 2 _____	_____ _____	_____ _____	\$ _____	<input type="checkbox"/>
3. _____ _____ _____	1 _____ 2 _____	_____ _____	_____ _____	\$ _____	<input type="checkbox"/>
4. _____ _____ _____	1 _____ 2 _____	_____ _____	_____ _____	\$ _____	<input type="checkbox"/>

I certify that the above listed Alaska Business License(s) and CONTRACTOR Registration(s), if applicable, were valid at the time Bids were opened for this Project.

CONTRACTOR, Authorized Signature

CONTRACTOR, Printed Name

COMPANY

SECTION 00360 - SUBCONTRACTOR REPORT

- A. A Bidder may replace a listed Subcontractor if the Subcontractor:
1. fails to comply with AS 08.18;
 2. files for bankruptcy or becomes insolvent;
 3. fails to execute a contract with the Bidder involving performance of the WORK for which the Subcontractor was listed and the Bidder acted in good faith;
 4. fails to obtain bonding;
 5. fails to obtain insurance acceptable to the OWNER;
 6. fails to perform the contract with the Bidder involving work for which the Subcontractor was listed;
 7. must be substituted in order for the CONTRACTOR to satisfy required state and federal affirmative action requirements;
 8. refuses to agree or abide with the Bidder's labor agreement; or
 9. is determined by the OWNER not to be responsible.
 10. is not in "Good Standing" with the OWNER as required in Article 21.0 in Section 00100 – Instructions to Bidders.
- B. If a Bidder fails to list a Subcontractor or lists more than one Subcontractor for the same portion of WORK, the Bidder shall be considered to have agreed to perform that portion of WORK without the use of a Subcontractor and to have represented the Bidder to be qualified to perform that WORK.
- C. A Bidder who attempts to circumvent the requirements of this section by listing as a Subcontractor another contractor who, in turn, sublets the majority of the WORK required under the contract violates this section.
- D. If a contract is awarded to a Bidder who violates this section, the OWNER may:
1. cancel the contract; or
 2. after notice and a hearing, assess a penalty on the Bidder in an amount that does not exceed 10 percent of the value of the subcontract at issue.
- E. On the Subcontractor Report, the apparent low Bidder must list any Subcontractors anticipated to perform WORK with a value of greater than one-half of one percent of the intended award amount, or \$2,000, whichever is less.
- F. An apparent low Bidder who fails to submit a completed Subcontractor Report within the time specified in this section may be found to be not a responsible Bidder and may be required to forfeit the Bid security. The OWNER will then consider the next lowest Bidder for award of the contract.

END OF SECTION

SECTION 00370 - CONTRACTOR'S FINANCIAL RESPONSIBILITY

To be considered, all bidders must complete and include this form *at the time of the deadline for bids*. Attach additional sheets as necessary to respond to questions.

PROJECT: BE20-259, CBJ Douglas Library Meeting Room Renovation

As the General Contractor on this project, I intend to subcontract _____% of the total value of this contract.

A. EXPERIENCE

1. Have you ever failed to complete a contract due to insufficient resources?

No Yes If YES, explain:

2. Describe arrangements you have made to finance this work:

3. Have you had previous construction contracts or subcontracts with the City and Borough of Juneau?

Yes No

4. Describe your most recent or current contract, its completion date, and scope of work:

5. List below, and/or as an attachment to this questionnaire, other construction projects you have completed, dates of completion, scope of work, and total contract amount for each project completed in the past twelve months.

SECTION 00370 - CONTRACTOR'S FINANCIAL RESPONSIBILITY

6. Per Alaska Statute 36.90.210, on previous public contracts, have you ever failed to pay a subcontractor within eight working days after receiving payment from the Owner (for projects occurring within the last 3 years)?

Yes No If yes, please attach a detailed explanation for each occurrence.

B. EQUIPMENT

1. Describe below, and/or as an attachment, the equipment you have available and intend to use for this project.

ITEM	QUANTITY	MAKE	MODEL	SIZE/CAPACITY	PRESENT MARKET VALUE

2. Do you propose to purchase any equipment for use on this project not listed on table B-1?

No Yes If YES, describe type, quantity, and approximate cost:

3. Do you propose to rent any equipment for this work not listed on table B-1?

No Yes If YES, describe type and quantity:

SECTION 00370 - CONTRACTOR'S FINANCIAL RESPONSIBILITY

4. Is your bid based on firm offers for all materials necessary for this project?

Yes No If NO, please explain:

I hereby certify that the above statements are true and complete.

Contractor

Name and Title of Person Signing

Signature

Date

SECTION 00500 - AGREEMENT

THIS AGREEMENT is between THE CITY AND BOROUGH OF JUNEAU (hereinafter called OWNER) and _____ (hereinafter called CONTRACTOR) OWNER and CONTRACTOR, in consideration of the mutual covenants hereinafter set forth, agree as follows:

ARTICLE 1. WORK.

CONTRACTOR shall complete the WORK as specified or as indicated under the Bid Schedule of the OWNERS Contract Documents **Contract No. BE20-259, CBJ Douglas Library Meeting Room Renovation.**

The WORK is generally described as follows: replace wood flooring with vinyl flooring and base; replace acoustical ceiling panels; patch and repair wall surfaces; paint walls; minor electrical work and patching, and miscellaneous related WORK.

The WORK to be paid under this contract shall include the following: Base Bid and Additive Alternate No. 1 as shown in Section 00310 - Bid Schedule.

ARTICLE 2. CONTRACT COMPLETION TIME.

The WORK must be completed within 120 days of issuance of the Notice to Proceed.

ARTICLE 3. DATE OF AGREEMENT

The date of this agreement will be the date of the last signature on page three of this section.

ARTICLE 4. LIQUIDATED DAMAGES.

OWNER and the CONTRACTOR recognize that time is of the essence of this Agreement and that the OWNER will suffer financial loss if the WORK is not completed within the time specified in Article 2 herein, plus any extensions thereof allowed in accordance with Article 12 of the General Conditions. They also recognize the delays, expense, and difficulties involved in proving in a legal proceeding the actual damages suffered by the OWNER if the WORK is not completed on time. Accordingly, instead of requiring any such proof, the OWNER and the CONTRACTOR agree that as liquidated damages for delay (but not as a penalty) the CONTRACTOR shall pay the OWNER **\$200** for each Day that expires after the completion time(s) specified in Article 2 herein. The amount of liquidated damages specified above is agreed to be a reasonable estimate based on all facts known as of the date of this Agreement.

ARTICLE 5. CONTRACT PRICE.

OWNER shall pay CONTRACTOR for completion of the WORK in accordance with the Contract Documents in current funds the amount set forth in the Bid Schedule. The CONTRACTOR agrees to accept as full and complete payment for all WORK to be done in this contract for: **Contract No. BE20-259, CBJ Douglas Library Meeting Room Renovation,** those Lump Sum amounts as set forth in the Bid Schedule in the Contract Documents for this Project.

The total amount of this contract shall be _____ (\$ _____), except as adjusted in accordance with the provisions of the Contract Documents.

SECTION 00500 - AGREEMENT

ARTICLE 6. PAYMENT PROCEDURES.

CONTRACTOR shall submit Applications for Payment in accordance with Article 14 of the General Conditions. Applications for Payment will be processed by the ARCHITECT as provided in the General Conditions.

Progress payments will be paid in full in accordance with Article 14 of the General Conditions until ninety (90) percent of the Contract Price has been paid. The remaining ten (10) percent of the Contract Price may be retained, in accordance with applicable Alaska State Statutes, until final inspection, completion, and acceptance of the Project by the OWNER.

ARTICLE 7. CONTRACT DOCUMENTS.

The Contract Documents which comprise the entire Agreement between OWNER and CONTRACTOR concerning the WORK consist of this Agreement (pages 00500-1 to 00500-6, inclusive) and the following sections of the Contract Documents:

- Table of Contents (pages 00030-1 to 00030-2, inclusive).
- Notice Inviting Bids (pages 00030-1 to 00030-2, inclusive).
- Instructions to Bidders (pages 00100-1 to 00100-8, inclusive).
- Bid (pages 00300-1 to 00300-2, inclusive).
- Bid Schedule (pages 00310-1, inclusive).
- Bid Bond (page 00320-1, inclusive) or Bid Security.
- Subcontractor Report (pages 00360-1 to 00360-2, inclusive).
- Contractor Financial Responsibility (pages 00370-1 to 00370-3, inclusive).
- Performance Bond (pages 00610-1 to 00610-2, inclusive).
- Payment Bond (pages 00620-1 to 00620-2, inclusive).
- Insurance Certificate(s).
- General Conditions (pages 00700-1 to 00700-44, inclusive).
- Supplementary General Conditions (pages 00800-1 to 00800-5, inclusive).
- Alaska Labor Standards, Reporting, and Prevailing Wage Determination (page 00830-1).
- Technical Specifications as listed in the Table of Contents.
- Drawings consisting of 7 sheets, as listed in the Table of Contents.
- Addenda numbers _____ to _____, inclusive.
- Change Orders which may be delivered or issued after the Date of the Agreement and which are not attached hereto.

There are no Contract Documents other than those listed in this Article 7. The Contract Documents may only be amended by Change Order as provided in Paragraph 3.3 of the General Conditions.

ARTICLE 8. MISCELLANEOUS.

Terms used in this Agreement which are defined in Article 1 of the General Conditions will have the meanings indicated in the General Conditions.

No assignment by a party hereto of any rights under or interests in the Contract Documents will be binding on another party hereto without the written consent of the party sought to be bound; and specifically but without limitation monies that may become due and monies that are due may not be assigned without such consent (except to the extent that the effect of this restriction may be limited by law), and unless specifically stated to the contrary in any written consent to an assignment, no assignment will release or discharge the assignor

SECTION 00500 - AGREEMENT

from any duty or responsibility under the Contract Documents.

OWNER and CONTRACTOR each binds itself, its partners, successors, assigns and legal representatives to the other party hereto, its partners, successors, assigns and legal representatives in respect of all covenants, agreements and obligations contained in the Contract Documents. This Agreement shall be governed by the laws of the State of Alaska. Jurisdiction shall be in the State of Alaska, First Judicial District.

IN WITNESS WHEREOF, OWNER and CONTRACTOR have caused this Agreement to be executed on the date listed below signed by OWNER.

OWNER:

CONTRACTOR:

City and Borough of Juneau

(Company Name)

(Signature)

(Signature)

By: Duncan Rorie Watt, City & Borough Manager
(Printed Name)

By: _____
(Printed Name, Authority or Title)

Date: _____

Date: _____
(CONTRACTOR Signature Date)

OWNER's address for giving notices:

CONTRACTOR's address for giving notices:

155 South Seward Street

Juneau, Alaska 99801

907-586-0873 907-586-4530
(Telephone) (Fax)

(Telephone) (Fax)

(E-mail address)

CONTRACTOR License No. _____

SECTION 00500 - AGREEMENT

CERTIFICATE
(if Corporation)

STATE OF)
) SS:
COUNTY OF)

I HEREBY CERTIFY that a meeting of the Board of Directors of the _____ a corporation existing under the laws of the State of _____, held on _____, 20____, the following resolution was duly passed and adopted:

“RESOLVED, that _____, as _____ President of the Corporation, be and is hereby authorized to **execute the Agreement** with the CITY AND BOROUGH OF JUNEAU and this corporation and that the execution thereof, attested by the Secretary of the Corporation, and with the Corporate Seal affixed, shall be the official act and deed of this Corporation.”

I further certify that said resolution is now in full force and effect.

IN WITNESS WHEREOF, I have hereunto set my hand and affixed the official seal of the corporation this _____ day of _____, 20_____.

Secretary

(SEAL)

SECTION 00500 - AGREEMENT

CERTIFICATE
(if Partnership)

STATE OF)
) SS:
COUNTY OF)

I HEREBY CERTIFY that a meeting of the Partners of the _____ a partnership existing under the laws of the State of _____, held on _____, 20____, the following resolution was duly passed and adopted:

"RESOLVED, that _____, as _____ of the Partnership, be and is hereby authorized to **execute the Agreement** with the CITY AND BOROUGH OF JUNEAU and this partnership and that the execution thereof, attested by the _____ shall be the official act and deed of this Partnership."

I further certify that said resolution is now in full force and effect.

IN WITNESS WHEREOF, I have hereunto set my hand this _____, day of _____, 20_____.

Secretary

(SEAL)

SECTION 00500 - AGREEMENT

**CERTIFICATE
(if Joint Venture)**

STATE OF)
) SS:
COUNTY OF)

I HEREBY CERTIFY that a meeting of the Principals of the
_____ a joint venture existing under the laws of the
State of _____, held on _____, 20____, the following resolution was duly passed and
adopted:

"RESOLVED, that _____, as _____ of the
Joint Venture, be and is hereby authorized to **execute the Agreement** with the CITY AND
BOROUGH OF JUNEAU and this joint venture and that the execution thereof, attested by the
_____ shall be the official act and deed of this Joint Venture."

I further certify that said resolution is now in full force and effect.

IN WITNESS WHEREOF, I have hereunto set my hand this _____, day of
_____, 20_____.

Secretary

(SEAL)

END OF SECTION

SECTION 00610 - PERFORMANCE BOND

KNOW ALL PERSONS BY THESE PRESENTS: That we _____
(Name of CONTRACTOR)

a _____
(Corporation, Partnership, Individual)

hereinafter called "Principal" and _____
(Surety)

of _____, State of _____ hereinafter called the "Surety", are held and firmly bound
to the CITY AND BOROUGH of JUNEAU, ALASKA hereinafter called "OWNER", for the penal sum
(Owner) (City and State)

of _____ dollars (\$ _____) in
lawful money of the United States, for the payment of which sum well and truly to be made, we bind ourselves,
our heirs, executors, administrators and successors, jointly and severally, firmly by these presents.

THE CONDITION OF THIS OBLIGATION is such that whereas, the CONTRACTOR has entered into a
certain contract with the OWNER, the effective date of which is (CBJ Contracts Office to fill in effective date)
_____, a copy of which is hereto attached and made a part hereof for the construction of:

**CBJ Douglas Library Meeting Room Renovation
CBJ Contract No. BE20-259**

NOW, THEREFORE, if the Principal shall truly and faithfully perform its duties, all the undertakings,
covenants, terms, conditions, and agreements of said contract during the original term thereof, and any extensions
thereof, which may be granted by the OWNER, with or without notice to the Surety, and if it shall satisfy all
claims and demands incurred under such contract, and shall fully indemnify and save harmless the OWNER from
all costs and damages which it may suffer by reason of failure to do so, and shall reimburse and repay the
OWNER all outlay and expense which the OWNER may incur in making good any default, then this obligation
shall be void; otherwise to remain in full force and effect.

PROVIDED, FURTHER, that the said Surety, for value received hereby stipulates and agrees that no
change, extension of time, alteration or addition to the terms of the contract or to the WORK to be performed
thereunder or the specifications accompanying the same shall in any wise affect its obligation on this bond, and it
does hereby waive notice of any such change, extension of time, alteration or addition to the terms of the contract
or to the WORK or to the Specifications.

PROVIDED, FURTHER, that no final settlement between the OWNER and the Principal shall abridge
the right of any beneficiary hereunder, whose claim may be unsatisfied.

SECTION 00610 - PERFORMANCE BOND

**CBJ Douglas Library Meeting Room Renovation
CBJ Contract No. BE20-259**

IN WITNESS WHEREOF, this instrument is issued in two (2) identical counterparts, each one of which shall be deemed an original.

CONTRACTOR:

By: _____
(Signature)

(Printed Name)

(Company Name)

(Mailing Address)

(City, State, Zip Code)

SURETY:

By: _____
(Signature of Attorney-in-Fact)

Date Issued: _____

(Printed Name)

(Company Name)

(Mailing Address)

(City, State, Zip Code)

(Affix SURETY'S SEAL)

NOTE: If CONTRACTOR is Partnership, all Partners must execute bond.

SECTION 00620 - PAYMENT BOND

KNOW ALL PERSONS BY THESE PRESENTS: That we _____
(Name of CONTRACTOR)

_____ a _____
(Corporation, Partnership, Individual)

hereinafter called "Principal" and _____
(Surety)

of _____, State of _____ hereinafter called the "Surety," are held and
firmly bound to the CITY AND BOROUGH of JUNEAU, ALASKA hereinafter called "OWNER," for the
(Owner) (City and State)

penal sum of _____ Dollars
(\$ _____) in lawful money of the United States, for the payment of which sum well
and truly to be made, we bind ourselves, our heirs, executors, administrators and successors, jointly and
severally, firmly by these presents.

THE CONDITION OF THIS OBLIGATION is such that Whereas, the CONTRACTOR has entered
into a certain contract with the OWNER, the effective date of which is (CBJ Contracts Office to fill in
effective date) _____, a copy of which is hereto attached and made a part hereof for
the construction of:

**CBJ Douglas Library Meeting Room Renovation
CBJ Contract No. BE20-259**

NOW, THEREFORE, if the Principal shall promptly make payment to all persons, firms,
Subcontractors, and corporations furnishing materials for, or performing labor in the prosecution of the
WORK provided for in such contract, and any authorized extension or modification thereof, including all
amounts due for materials, lubricants, oil, gasoline, coal and coke, repairs on machinery, equipment and tools,
consumed or used in connection with the construction of such WORK, and all insurance premiums on said
work, and for all labor performed in such WORK, whether by Subcontractor or otherwise, then this obligation
shall be void; otherwise to remain in full force and effect.

PROVIDED, FURTHER, that the said Surety, for value received hereby stipulates and agrees that no
change, extension of time, alteration or addition to the terms of the contract or to the WORK to be performed
thereunder or the specifications accompanying the same shall in any wise affect its obligation on this bond,
and it does hereby waive notice of any such change, extension of time, alteration or addition to the terms of
the contract or to the WORK or to the Specifications.

PROVIDED, FURTHER, that no final settlement between the OWNER and the Principal shall
abridge the right of any beneficiary hereunder, whose claim may be unsatisfied.

SECTION 00620 - PAYMENT BOND

**CBJ Douglas Library Meeting Room Renovation
CBJ Contract No. BE20-259**

IN WITNESS WHEREOF, this instrument is issued in two (2) identical counterparts, each one of which shall be deemed an original.

CONTRACTOR:

By: _____
(Signature)

(Printed Name)

(Company Name)

(Mailing Address)

(City, State, Zip Code)

SURETY:

By: _____
(Signature of Attorney-in-Fact)

Date Issued: _____

(Printed Name)

(Company Name)

(Mailing Address)

(City, State, Zip Code)

(Affix SURETY'S SEAL)

NOTE: If CONTRACTOR is Partnership, all Partners must execute bond.

SECTION 00700 - GENERAL CONDITIONS

TABLE OF CONTENTS

ARTICLE 1 DEFINITIONS 00700-5

ARTICLE 2 PRELIMINARY MATTERS

2.1 Delivery of Bonds/Insurance Certificates 00700-9
2.2 Copies of Documents 00700-9
2.3 Commencement of Contract Time; Notice to Proceed 00700-9
2.4 Starting the WORK 00700-9
2.5 Pre-construction Conference 00700-9
2.6 Finalizing CONTRACTOR Submittals 00700-9

ARTICLE 3 CONTRACT DOCUMENTS: INTENT, AMENDING, REUSE

3.1 Intent 00700-10
3.2 Order of Precedence of Contract Documents 00700-10
3.3 Amending and Supplementing Contract Documents 00700-11
3.4 Reuse of Documents 00700-11

ARTICLE 4 AVAILABILITY OF LANDS; PHYSICAL CONDITIONS; REFERENCE POINTS

4.1 Availability of Lands 00700-11
4.2 Physical Conditions - Subsurface and Existing Structures 00700-11
4.3 Differing Site Conditions 00700-12
4.4 Physical Conditions - Underground Utilities 00700-12
4.5 Reference Points 00700-13
4.6 Use of the CBJ/State Lemon Creek Gravel Pit 00700-13

ARTICLE 5 BONDS AND INSURANCE

5.1 Performance, Payment and Other Bonds 00700-14
5.2 Insurance 00700-15

ARTICLE 6 CONTRACTOR'S RESPONSIBILITIES

6.1 Supervision and Superintendence 00700-16
6.2 Labor, Materials, and Equipment 00700-17
6.3 Adjusting Progress Schedule 00700-18
6.4 Substitutes or "Or Equal" Items 00700-18
6.5 Concerning Subcontractors, Suppliers and Others 00700-18
6.6 Permits 00700-18
6.7 Patent Fees and Royalties 00700-19
6.8 Laws and Regulations 00700-19

SECTION 00700 - GENERAL CONDITIONS

TABLE OF CONTENTS

ARTICLE 6 CONTRACTOR'S RESPONSIBILITIES (Cont'd.)

6.9 Taxes 00700-19
6.10 Use of Premises..... 00700-19
6.11 Safety and Protection 00700-20
6.12 Shop Drawings and Samples..... 00700-21
6.13 Continuing the WORK..... 00700-21
6.14 Indemnification 00700-21
6.15 CONTRACTOR's Daily Reports 00700-22
6.16 Assignment of Contract..... 00700-22
6.17 CONTRACTOR's Responsibility for Utility Property and Services 00700-22
6.18 Operating Water System Valves 00700-22
6.19 Contractor's Work Schedule Limitations..... 00700-23

ARTICLE 7 OTHER WORK

7.1 Related Work at Site 00700-23
7.2 Coordination 00700-23

ARTICLE 8 OWNER'S RESPONSIBILITIES

8.1 Communications 00700-24
8.2 Payments 00700-24
8.3 Lands, Easements, and Surveys 00700-24
8.4 Change Orders..... 00700-24
8.5 Inspections and Tests 00700-24
8.6 Suspension of WORK..... 00700-24
8.7 Termination of Agreement..... 00700-24

ARTICLE 9 ARCHITECT'S STATUS DURING CONSTRUCTION

9.1 OWNER's Representative 00700-24
9.2 Visits to Site 00700-24
9.3 Project Representation 00700-24
9.4 Clarifications and Interpretations 00700-24
9.5 Authorized Variations in WORK..... 00700-25
9.6 Rejecting or Accepting Defective WORK..... 00700-25
9.7 CONTRACTOR Submittals, Change Orders, and Payments 00700-25
9.8 Decisions on Disputes 00700-25
9.9 Limitation on ARCHITECT's Responsibilities..... 00700-26

SECTION 00700 - GENERAL CONDITIONS

TABLE OF CONTENTS

ARTICLE 10 CHANGES IN THE WORK

10.1 General 00700-26
10.2 Allowable Quantity Variations 00700-27

ARTICLE 11 CHANGE OF CONTRACT PRICE

11.1 General 00700-27
11.2 Costs Relating to Weather 00700-28
11.3 Cost of WORK (Based on Time and Materials) 00700-28
11.4 CONTRACTOR's Fee 00700-31
11.5 Excluded Costs 00700-31

ARTICLE 12 CHANGE OF CONTRACT TIME

12.1 General 00700-32
12.2 Extensions of Time for Delay Due to Weather 00700-33

**ARTICLE 13 WARRANTY AND GUARANTEE; TESTS AND INSPECTIONS;
CORRECTION, REMOVAL, OR ACCEPTANCE OF DEFECTIVE WORK**

13.1 Warranty and Guarantee 00700-33
13.2 Access to WORK 00700-33
13.3 Inspections and Tests 00700-33
13.4 OWNER May Stop the WORK 00700-34
13.5 Correction or Removal of Defective WORK 00700-34
13.6 One Year Correction Period 00700-34
13.7 Acceptance of Defective WORK 00700-35

ARTICLE 14 PAYMENTS TO CONTRACTOR AND COMPLETION

14.1 Schedule of Values (Lump Sum Price Breakdown) 00700-35
14.2 Unit Price Bid Schedule 00700-35
14.3 Application for Progress Payment 00700-35
14.4 CONTRACTOR's Warranty of Title 00700-36
14.5 Review of Applications for Progress Payment 00700-36
14.6 Partial Utilization 00700-37
14.7 Substantial Completion 00700-37
14.8 Final Application for Payment 00700-37
14.9 Final Payment and Acceptance 00700-37
14.10 Release of Retainage and Other Deductions 00700-38
14.11 CONTRACTOR's Continuing Obligation 00700-38
14.12 Final Payment Terminates Liability of OWNER 00700-38

SECTION 00700 - GENERAL CONDITIONS

TABLE OF CONTENTS

ARTICLE 15 SUSPENSION OF WORK AND TERMINATION

15.1 Suspension of WORK by OWNER 00700-39
15.2 Termination of Agreement by OWNER (CONTRACTOR Default)..... 00700-39
15.3 Termination of Agreement by OWNER (For Convenience) 00700-39
15.4 Termination of Agreement by CONTRACTOR 00700-39

ARTICLE 16 MISCELLANEOUS

16.1 Giving Notice 00700-40
16.2 Rights In and Use of Materials Found on the WORK 00700-40
16.3 Right to Audit 00700-41
16.4 Archaeological or Historical Discoveries 00700-41
16.5 Construction Over or Adjacent to Navigable Waters..... 00700-41
16.6 Gratuity and Conflict of Interest 00700-41
16.7 Suits of Law Concerning the WORK 00700-41
16.8 Certified Payrolls 00700-42
16.9 Prevailing Wage Rates 00700-42
16.10 Employment Reference 00700-42
16.11 Cost Reduction Incentive 00700-43

SECTION 00700 - GENERAL CONDITIONS

ARTICLE 1 DEFINITIONS

Wherever used in these General Conditions or in the Contract Documents the following terms have the meanings indicated which are applicable to both the singular and plural thereof. Where a word is capitalized in the definitions and is found not capitalized in the Contract Documents it has the ordinary dictionary definition.

Addenda - Written or graphic instruments issued prior to the opening of Bids which make additions, deletions, or revisions to the Contract Documents.

Agreement - The written contract between the OWNER and the CONTRACTOR covering the WORK to be performed; other documents are attached to the Agreement and made a part thereof as provided therein.

Application for Payment - The form furnished by the ARCHITECT which is to be used by the CONTRACTOR to request progress or final payment and which is to be accompanied by such supporting documentation as is required by the Contract Documents.

ARCHITECT - The ARCHITECT is the firm or person(s) selected by the City and Borough of Juneau (CBJ) to perform the duties of project inspection and management. CBJ will inform the CONTRACTOR of the identity of the ARCHITECT at or before the Notice to Proceed.

Architect of Record – The individual, partnership, corporation, joint-venture or other legal entity legally responsible for preparation of Design and Construction Documents for the project.

Asbestos - Any material that contains more than one percent asbestos and is friable or is releasing asbestos fibers into the air above current action levels established by the United States Occupational Safety and Health Administration.

Bid - The offer or proposal of the Bidder submitted on the prescribed form setting forth the price or prices for the WORK.

Bonds - Bid, Performance, and Payment Bonds and other instruments which protect against loss due to inability or refusal of the CONTRACTOR to perform its contract.

CBJ - City and Borough of Juneau

CBJ Project Manager - The authorized representative of the City and Borough of Juneau Engineering Department, as OWNER, who is responsible for administration of the contract.

Change Order - A document recommended by the ARCHITECT, which is signed by the CONTRACTOR and the OWNER and authorizes an addition, deletion, or revision in the WORK, or an adjustment in the Contract Price or the Contract Time, issued on or after the Effective Date of the Agreement.

Contract Documents - The Table of Contents, Notice Inviting Bids, Instructions to Bidders, Bid Forms (including the Bid, Bid Schedule(s), Information Required of Bidder, Bid Bond, and all required certificates and affidavits), Agreement, Performance Bond, Payment Bond, General Conditions, Supplementary General Conditions, Technical Specifications, Drawings, Permits, and all Addenda, Field Orders and Change Orders executed pursuant to the provisions of the Contract Documents.

SECTION 00700 - GENERAL CONDITIONS

Contract Price - The total monies payable by the OWNER to the CONTRACTOR under the terms and conditions of the Contract Documents.

Contract Time - The number of successive calendar Days or the specific date stated in the Contract Documents for the completion of the WORK.

CONTRACTOR - The individual, partnership, corporation, joint-venture or other legal entity with whom the OWNER has executed the Agreement.

Day - A calendar day of 24 hours measured from midnight to the next midnight.

Defective WORK - WORK that is unsatisfactory, faulty, or deficient; or that does not conform to the Contract Documents; or that does not meet the requirements of any inspection, reference standard, test, or approval referred to in the Contract Documents; or WORK that has been damaged prior to the ARCHITECT's recommendation of final payment.

Drawings - The drawings, plans, maps, profiles, diagrams, and other graphic representations which indicate the character, location, nature, extent, and scope of the WORK and which have been prepared by the Architect of Record and are referred to in the Contract Documents. Shop Drawings are not within the meaning of this paragraph.

Effective Date of the Agreement - The date indicated in the Agreement on which it becomes effective, but if no such date is indicated it means the date on which the Agreement is signed and delivered by the last of the two parties to sign and deliver.

Field Order - A written order issued by the ARCHITECT which may or may not involve a change in the WORK.

General Requirements - Division 1 of the Technical Specifications.

Hazardous Waste - The term Hazardous Waste shall have the meaning provided in Section 1004 of the Solid Waste Disposal Act (42 USC Section 9603) as amended from time to time.

Holidays - The CBJ legal holidays occur on:

- A. New Year's Day - January 1
- B. Martin Luther King's Birthday - Third Monday in January
- C. President's Day - Third Monday in February
- D. Seward's Day - Last Monday in March
- E. Memorial Day - Last Monday in May
- F. Independence Day - July 4
- G. Labor Day - First Monday in September
- H. Alaska Day - October 18
- I. Veteran's Day - November 11
- J. Thanksgiving Day - Fourth Thursday and the following Friday in November
- K. Christmas Day - December 25.

SECTION 00700 - GENERAL CONDITIONS

If any holiday listed above falls on a Saturday, Saturday and the preceding Friday are both legal holidays. If the holiday should fall on a Sunday, Sunday and the following Monday are both legal holidays.

Inspector - The authorized representative of the ARCHITECT assigned to make detailed inspections for conformance to the Contract Documents. Any reference to the Resident Project Representative in this document shall mean the Inspector.

Laws and Regulations; Laws or Regulations - Any and all applicable laws, rules, regulations, ordinances, codes, and/or orders of any and all governmental bodies, agencies, authorities and courts having jurisdiction.

Mechanic's Lien - A form of security, an interest in real property, which is held to secure the payment of an obligation. When referred to in these Contract Documents, "Mechanic's Lien" or "lien" means "Stop Notice".

Milestone - A principal event specified in the Contract Documents relating to an intermediate completion date of a portion of the work, or a period of time within which the portion of the work should be performed prior to Substantial Completion of all the WORK.

Notice of Intent to Award - The written notice by the OWNER to the apparent successful bidder stating that upon compliance by the apparent successful bidder with the requirements listed therein, within the time specified, the OWNER will enter into an Agreement.

Notice of Award - The written notice by the OWNER to the apparent successful bidder stating that the apparent successful bidder has complied with all conditions for award of the contract.

Notice of Completion - A form signed by the ARCHITECT and the CONTRACTOR recommending to the OWNER that the WORK is Substantially Complete and fixing the date of Substantial Completion. After acceptance of the WORK by the OWNER's governing body, the form is signed by the OWNER. This filing starts the 30 day lien filing period on the WORK.

Notice to Proceed - The written notice issued by the OWNER to the CONTRACTOR authorizing the CONTRACTOR to proceed with the WORK and establishing the date of commencement of the Contract Time.

OWNER - The City and Borough of Juneau (CBJ), acting through its legally designated officials, officers, or employees.

Partial Utilization - Use by the OWNER of a substantially completed part of the WORK for the purpose for which it is intended prior to Substantial Completion of all the WORK.

PCB's - Polychlorinated biphenyls.

Petroleum - Petroleum, including crude oil or any fraction thereof which is liquid at standard conditions of temperature and pressure (60 degrees Fahrenheit and 14.7 pounds per square inch absolute), such as oil, petroleum, fuel oil, oil sludge, oil refuse, gasoline, kerosene, and oil mixed with other non-Hazardous Wastes and crude oils.

Project - The total construction of which the WORK to be provided under the Contract Documents may be the whole, or a part as indicated elsewhere in the Contract Documents.

SECTION 00700 - GENERAL CONDITIONS

Radioactive Material - Source, special nuclear, or byproduct material as defined by the Atomic Energy Act of 1954 (42 USC Section 2011 et seq.) as amended from time to time.

Shop Drawings - All drawings, diagrams, illustrations, schedules and other data which are specifically prepared by or for the CONTRACTOR and submitted by the CONTRACTOR, to the ARCHITECT, to illustrate some portion of the WORK.

Specifications - Same definition as for "Technical Specifications" hereinafter.

Stop Notice - A legal remedy for subcontractors and suppliers who contribute to public works, but who are not paid for their work, which secures payment from construction funds possessed by the OWNER. For public property, the Stop Notice remedy is designed to substitute for mechanic's lien rights.

Sub-Consultant - The individual, partnership, corporation, joint-venture or other legal entity having a direct contract with Architect of Record, or with any of its Consultants to furnish services with respect to the Project.

Subcontractor - An individual, partnership, corporation, joint-venture or other legal entity having a direct contract with the CONTRACTOR, or with any of its Subcontractors, for the performance of a part of the WORK at the site.

Substantial Completion - Refers to when the WORK has progressed to the point where, in the opinion of the ARCHITECT as evidenced by Notice of Completion as applicable, it is sufficiently complete, in accordance with the Contract Documents, so that the WORK can be utilized for the purposes for which it is intended; or if no such notice is issued, when final payment is due in accordance with Paragraph 14.8. The terms "substantially complete" and "substantially completed" as applied to any WORK refer to Substantial Completion thereof.

Supplementary General Conditions - The part of the Contract Documents which make additions, deletions, or revisions to these General Conditions.

Supplier - A manufacturer, fabricator, supplier, distributor, material man, or vendor.

Technical Specifications - Divisions 1 through 16 of the Contract Documents consisting of the General Requirements and written technical descriptions of products and execution of the WORK.

Underground Utilities - All pipelines, conduits, ducts, cables, wires, manholes, vaults, tanks, tunnels, or other such facilities or attachments, and any encasements containing such facilities which have been installed underground to furnish any of the following services or materials: water, sewage and drainage removal, electricity, gases, steam, liquid petroleum products, telephone or other communications, cable television, traffic, or other control systems.

WORK, Work - The entire completed construction or the various separately identifiable parts thereof required to be furnished under the Contract Documents. WORK is the result of performing, or furnishing labor and furnishing and incorporating materials and equipment into the construction, and performing or furnishing services and furnishing documents, all as required by the Contract Documents.

SECTION 00700 - GENERAL CONDITIONS

ARTICLE 2 PRELIMINARY MATTERS

- 2.1 DELIVERY OF BONDS/INSURANCE CERTIFICATES. When the CONTRACTOR delivers the signed Agreements to the OWNER, the CONTRACTOR shall also deliver to the OWNER such Bonds and Insurance Policies and Certificates as the CONTRACTOR may be required to furnish in accordance with the Contract Documents.
- 2.2 COPIES OF DOCUMENTS. The OWNER shall furnish to the CONTRACTOR the required number of copies of the Contract Documents specified in the Supplementary General Conditions.
- 2.3 COMMENCEMENT OF CONTRACT TIME; NOTICE TO PROCEED. The Contract Time will start to run on the commencement date stated in the Notice to Proceed. If no date is stated, Contract Time shall commence upon the date of the Notice to Proceed is issued.
- 2.4 STARTING THE WORK
- A. The CONTRACTOR shall begin to perform the WORK within 10 days after the commencement date stated in the Notice to Proceed, but no WORK shall be done at the site prior to said commencement date.
 - B. Before undertaking each part of the WORK, the CONTRACTOR shall carefully study and compare the Contract Documents and check and verify pertinent figures shown thereon and all applicable field measurements. The CONTRACTOR shall promptly report in writing to the ARCHITECT any conflict, error, or discrepancy which the CONTRACTOR may discover and shall obtain a written interpretation or clarification from the ARCHITECT before proceeding with any WORK affected thereby.
 - C. The CONTRACTOR shall submit to the ARCHITECT for review those documents called for under Section 01300 - CONTRACTOR Submittals in the General Requirements.
- 2.5 PRE-CONSTRUCTION CONFERENCE. The CONTRACTOR is required to attend a Pre-Construction Conference. This conference will be attended by the ARCHITECT and others as appropriate in order to discuss the WORK in accordance with the applicable procedures specified in the General Requirements, Section 01010 - Summary of Work.
- 2.6 FINALIZING CONTRACTOR SUBMITTALS. At least 7 days before submittal of the first Application for Payment a conference attended by the CONTRACTOR, the ARCHITECT and others as appropriate will be held to finalize the initial CONTRACTOR submittals in accordance with the General Requirements. As a minimum the CONTRACTOR's representatives should include it's project manager and schedule expert. The CONTRACTOR should plan on this meeting taking no less than 8 hours. If the submittals are not finalized at the end of the meeting, additional meetings will be held so that the submittals can be finalized prior to the submittal of the first Application for Payment. No Application for Payment will be processed until CONTRACTOR submittals are finalized.

SECTION 00700 - GENERAL CONDITIONS

ARTICLE 3 CONTRACT DOCUMENTS: INTENT, AMENDING, REUSE

3.1 INTENT

- A. The Contract Documents comprise the entire agreement between the OWNER and the CONTRACTOR concerning the WORK. The Contract Documents shall be construed as a whole in accordance with Alaska Law.
- B. It is the intent of the Contract Documents to describe the WORK, functionally complete, to be constructed in accordance with the Contract Documents. Any WORK, materials, or equipment that may reasonably be inferred from the Contract Documents as being required to produce the intended result shall be supplied whether or not specifically called for. When words or phrases which have a well-known technical or construction industry or trade meaning are used to describe WORK, materials, or equipment such words or phrases shall be interpreted in accordance with that meaning, unless a definition has been provided in Article 1 of the General Conditions. Reference to standard specifications, manuals, or codes of any technical society, organization, or association, or to the Laws or Regulations of any governmental authority, whether such reference be specific or by implication, shall mean the latest standard specification, manual, code, or Laws or Regulations in effect at the time of opening of Bids, except as may be otherwise specifically stated. However, no provision of any referenced standard specification, manual, or code (whether or not specifically incorporated by reference in the Contract Documents) shall be effective to change the duties and responsibilities of the ARCHITECT, OWNER, the CONTRACTOR, or the Architect of Record or any of their consultants, agents, or employees from those set forth in the Contract Documents.
- C. If, during the performance of the WORK, CONTRACTOR discovers any conflict, error, ambiguity or discrepancy within the Contract Documents or between the Contract Documents and any provision of any such Law or Regulation applicable to the performance of the WORK or of any such standard, specification, manual or code or of any instruction of any Supplier referred to in paragraph 6.5, the CONTRACTOR shall report it to the ARCHITECT in writing at once, and the CONTRACTOR shall not proceed with the WORK affected thereby (except in an emergency as authorized by the ARCHITECT) until a clarification Field Order, or Change Order to the Contract Documents has been issued.

3.2 ORDER OF PRECEDENCE OF CONTRACT DOCUMENTS

- A. In resolving conflicts resulting from, errors, or discrepancies in any of the Contract Documents, the order of precedence shall be as follows:
 - 1. Permits from other agencies as may be required by law, excepting the definition of "Permittee" in these permits.
 - 2. Field Orders
 - 3. Change Orders
 - 4. ARCHITECT's written interpretations and clarifications.
 - 5. Agreement
 - 6. Addenda
 - 7. CONTRACTOR's Bid (Bid Form)
 - 8. Supplementary General Conditions
 - 9. Notice Inviting Bids
 - 10. Instructions to Bidders

SECTION 00700 - GENERAL CONDITIONS

11. General Conditions
12. Technical Specifications
13. Drawings

B. With reference to the Drawings the order of precedence is as follows:

1. Figures govern over scaled dimensions
2. Detail drawings govern over general drawings
3. Addenda/Change Order drawings govern over contract Drawings
4. Contract Drawings govern over standard details

3.3 AMENDING AND SUPPLEMENTING CONTRACT DOCUMENTS. The Contract Documents may be amended to provide for additions, deletions, and revisions in the WORK or to modify the terms and conditions thereof by a Change Order (pursuant to Article 10 CHANGES IN THE WORK).

3.4 REUSE OF DOCUMENTS. Neither the CONTRACTOR, nor any Subcontractor or Supplier, nor any other person or organization performing any of the WORK under a contract with the OWNER shall have or acquire any title to or ownership rights in any of the Drawings, Technical Specifications, or other documents used on the WORK, and they shall not reuse any of them on the extensions of the Project or any other project without written consent of the OWNER.

ARTICLE 4 AVAILABILITY OF LANDS; PHYSICAL CONDITIONS; REFERENCE POINTS

4.1 AVAILABILITY OF LANDS. The OWNER shall furnish, as indicated in the Contract Documents, the lands upon which the WORK is to be performed, rights-of-way and easements for access thereto, and such other lands which are designated for the use of the CONTRACTOR. Easements for permanent structures or permanent changes in existing facilities will be obtained and paid for by the OWNER, unless otherwise provided in the Contract Documents. Nothing contained in the Contract Documents shall be interpreted as giving the CONTRACTOR exclusive occupancy of the lands or rights-of-way provided. The CONTRACTOR shall provide for all additional lands and access thereto that may be required for temporary construction facilities or storage of materials and equipment; provided, that the CONTRACTOR shall not enter upon nor use any property not under the control of the OWNER until a written temporary construction easement, lease or other appropriate agreement has been executed by the CONTRACTOR and the property owner, and a copy of said agreement furnished to the ARCHITECT prior to said use; and, neither the OWNER nor the ARCHITECT shall be liable for any claims or damages resulting from the CONTRACTOR's unauthorized trespass or use of any such properties.

4.2 PHYSICAL CONDITIONS - SUBSURFACE AND EXISTING STRUCTURES

A. Explorations and Reports. Reference is made to SGC 4.2 Physical Conditions of the Supplementary General Conditions for identification of those reports of explorations and tests of sub-surface conditions at the site that have been utilized by the Architect of Record in the preparation of the Contract Documents. The CONTRACTOR may rely upon the accuracy of the technical data contained in such reports, however, reports are not to be considered complete or comprehensive and nontechnical data, interpretations, and opinions contained in such reports are not to be relied on by the CONTRACTOR. The CONTRACTOR is responsible for any further explorations or tests that

SECTION 00700 - GENERAL CONDITIONS

may be necessary and any interpretation, interpolation, or extrapolation that it makes of any information shown in such reports.

- B. Existing Structures. Reference is made to SGC 4.2 Physical Conditions of the Supplementary General Conditions for identification of those drawings of physical conditions in or relating to existing surface and subsurface structures (except Underground Utilities referred to in Paragraph 4.4 herein) which are at or contiguous to the site that have been utilized by the Architect of Record in the preparation of the Contract Documents. The CONTRACTOR may rely upon the accuracy of the technical data contained in such drawings, however, nontechnical data, interpretations, and opinions contained in such drawings are not to be relied on by the CONTRACTOR. The CONTRACTOR is also responsible for any interpretation, interpolation, or extrapolation that it makes of any information shown in such drawings.

4.3 DIFFERING SITE CONDITIONS

- A. The CONTRACTOR shall promptly upon discovery (but in no event later than 14 days thereafter) and before the following conditions are disturbed, notify the ARCHITECT, in writing of any:
 - 1. Material that the CONTRACTOR believes may be material that is hazardous waste, as defined in Article 1 of these General Conditions, or asbestos, PCB's, petroleum or any other substance or material posing a threat to human or to the environment.
 - 2. Subsurface or latent physical conditions at the site differing from those indicated.
 - 3. Unknown physical conditions at the site of any unusual nature, different materially from those ordinarily encountered and generally recognized as inherent in WORK of the character provided for in the contract.
- B. The ARCHITECT shall promptly investigate the conditions, and if it finds that the conditions do materially so differ, or do involve hazardous waste, and cause a decrease or increase in the CONTRACTOR's cost of, or the time required for, performance of any part of the WORK shall issue a Change Order under the procedures described in the contract.
- C. In the event that a dispute arises between the ARCHITECT and the CONTRACTOR whether the conditions materially differ, or involved hazardous waste or other materials listed above, or cause a decrease or increase in the CONTRACTOR's cost of, or time required for, performance of any part of the WORK, the CONTRACTOR shall not be excused from any scheduled completion date provided for by the contract, but shall proceed with all WORK to be performed under the contract. The CONTRACTOR shall retain any and all rights provided either by contract or by Law which pertain to the resolution of disputes and protests between the contracting parties.

4.4 PHYSICAL CONDITIONS - UNDERGROUND UTILITIES

- A. Indicated. The information and data indicated in the Contract Documents with respect to existing Underground Utilities at or contiguous to the site are based on information and data furnished to the OWNER or the Architect of Record by the owners of such Underground Utilities or by others. Unless it is expressly provided in the Supplementary General Conditions and/or Section 01530 - Protection and Restoration of Existing Facilities, the OWNER and the Architect of Record shall not be responsible for the accuracy or completeness of any such information or data, and the CONTRACTOR shall have full responsibility for reviewing and checking all such information and data, for locating all Underground Utilities indicated in the Contract Documents, for coordination of

SECTION 00700 - GENERAL CONDITIONS

the WORK with the owners of such Underground Utilities during construction, for the safety and protection thereof and repairing any damage thereto resulting from the WORK, the cost of which will be considered as having been included in the Contract Price.

- B. Not Indicated. If an Underground Utility is uncovered or revealed at or contiguous to the site which was not indicated in the Contract Documents and which the CONTRACTOR could not reasonably have been expected to be aware of, the CONTRACTOR shall identify the owner of such Underground Utility and give written notice thereof to that owner and shall notify the ARCHITECT in accordance with the requirements of the Supplementary General Conditions and Section 01530 - Protection and Restoration of Existing Facilities of the General Requirements.

4.5 REFERENCE POINTS

- A. The ARCHITECT will provide one bench mark, near or on the site of the WORK, and will provide two points near or on the site to establish a base line for use by the CONTRACTOR for alignment control. Unless otherwise specified in the General Requirements, the CONTRACTOR shall furnish all other lines, grades, and bench marks required for proper execution of the WORK.
- B. The CONTRACTOR shall preserve all bench marks, stakes, and other survey marks, and in case of their removal or destruction by its own employees or by its subcontractor's employees, the CONTRACTOR shall be responsible for the accurate replacement of such reference points by personnel qualified under the Alaska Statute governing the licensing of architects, engineers, and land surveyors.

4.6 USE OF THE CBJ/STATE LEMON CREEK GRAVEL PIT

- A. On City and Borough of Juneau (CBJ) construction projects, the CBJ may make unclassified material available to CONTRACTORS, from the CBJ/State Lemon Creek gravel pit, at a rate less than charged other customers. CONTRACTORS are not required to use material from the CBJ/State pit and the CBJ makes no guarantee as to the quantity or quality of the available material. For this Project, contact Alec Venechuk, CBJ Material Source Manager, at (907) 586-0874 for the current material rates.
- B. CONTRACTORS proposing to use gravel from the CBJ/State pit are required to be in good standing for all amounts owed to the CBJ, for previous gravel operations, prior to submitting a mining plan for approval. CONTRACTORS using the pit must comply with Allowable Use Permit USE 2008-00061. Failure to meet these requirements, if so subject, shall be sufficient reason to deny use of the CBJ/State pit as a gravel source. To determine if your company is subject to these requirements, contact the CBJ Engineering Department, Gravel Pit Management, at (907) 586-0874.
- C. CONTRACTORS deciding to use material from the CBJ/State pit shall provide an Individual Mining Plan prepared by a professional engineer registered in the State of Alaska. The Individual Mining Plan must be reviewed and approved by the CBJ, prior to commencing operations within the pit. CONTRACTORS shall also secure a Performance Bond to ensure compliance with contract provisions, including any Individual Mining Plan stipulations. The bond shall remain in full force and effect until a release is obtained from the CBJ.
- D. If CONTRACTOR operations for a Project do not exceed 500 tons of material, the CONTRACTOR will not be required to provide an Individual Mining Plan prepared by an engineer, however, the

SECTION 00700 - GENERAL CONDITIONS

CONTRACTOR must submit an Individual Mining Plan that is in compliance with Allowable Use Permit USE 2008-00061 for gravel extraction within the CBJ/State pit. The CONTRACTOR must contact the CBJ Engineering Department for conditions for the extraction.

- E. CONTRACTORS using the CBJ material may do primary dry separation (screening) of materials within the pit. Crushing and washing of material will not be allowed. CONTRACTORS shall account for placement of materials removed from the pit. The CBJ may require CONTRACTORS to cross-check weight tickets, submit to an audit, or participate in other measures required by the CBJ to ensure accountability. Unprocessed overburden removed from the pit will not be weighed. All other material mined will be weighed at the CBJ scale. CONTRACTORS will be responsible for loading and/or screening their own material. If asphalt pavement is removed as part of the WORK, CONTRACTORS shall dispose of the material at a to-be-specified location within the pit area, as directed by the CBJ Gravel Pit Manager, (907) 586-0874.
- F. The gravel pit overhead charge shall be paid to the CBJ by the CONTRACTOR within 60 days after removal of all materials from the pit and prior to requesting and/or receiving final payment. Upon completion of each excavation CONTRACTORS shall notify the CBJ, in writing, in sufficient time to perform a field-compliance examination prior to vacating the pit. Any significant deviation from the stipulations of the Individual Mining Plan identified during the field inspection shall be corrected by the CONTRACTOR prior to release of the bond. A signed release from CBJ will be required prior to releasing the CONTRACTOR's bond.
- G. If asphalt pavement is removed as part of this WORK, the CONTRACTOR shall dispose of the material at the location designated as the Asphalt Storage Facility, or as directed by the ARCHITECT.
- H. The CBJ/State Pit is a seasonal operation. The hours of operation are from 7:00 a.m. to 6:00 p.m., Monday through Friday, from April 1 through October 15 of the year. CONTRACTORS may obtain gravel on weekends, or during the off-season, by applying for a separate agreement with the City and Borough of Juneau Engineering Department. The CONTRACTOR will be responsible for any additional costs incurred during weekend or off-season operations at the gravel pit.
- I. All CONTRACTORS/equipment operators using the CBJ/State Pit shall be in compliance with Federal Mine Safety and Health Administration regulations for quarry and gravel operations.

ARTICLE 5 BONDS AND INSURANCE

5.1 PERFORMANCE, PAYMENT, AND OTHER BONDS

- A. The CONTRACTOR shall furnish Performance and Payment Bonds, each in the amount set forth in the Supplementary General Conditions as security for the faithful performance and payment of all the CONTRACTOR's obligations under the Contract Documents. These bonds shall remain in effect at least until one year after the date of Substantial Completion except as otherwise provided by Law or Regulation or by the Contract Documents. The CONTRACTOR shall also furnish such other Bonds as are required by the Supplementary General Conditions. All Bonds shall be in the form prescribed by the Contract Documents except as provided otherwise by Laws or Regulations, and shall be executed by such sureties as are named in the current list of "Companies Holding Certificates of Authority as Acceptable Sureties on Federal Bonds and as Acceptable Reinsuring Companies" as published in Circular 570 (amended) by the Audit Staff, Bureau of Government Financial Operations,

SECTION 00700 - GENERAL CONDITIONS

U.S. Treasury Department. All Bonds signed by an agent must be accompanied by a certified copy of such agent's authority to act.

- B. If the surety on any Bond furnished by the CONTRACTOR is declared bankrupt or becomes insolvent or its right to do business is terminated in any state where any part of the WORK is located, the CONTRACTOR shall within 7 days thereafter substitute another Bond and Surety, which must be acceptable to the OWNER.
- C. All Bonds required by the Contract Documents to be purchased and maintained by CONTRACTOR shall be obtained from surety companies that are duly licensed or authorized in the State of Alaska to issue Bonds for the limits so required. Such surety companies shall also meet such additional requirements and qualifications as may be provided in the Supplementary General Conditions.

5.2 INSURANCE

- A. The CONTRACTOR shall purchase and maintain the insurance required under this paragraph. Such insurance shall include the specific coverages set out herein and be written for not less than the limits of liability and coverages provided in the Supplementary General Conditions, or required by law, whichever are greater. All insurance shall be maintained continuously during the life of the Agreement up to the date of Final Completion and at all times thereafter when the CONTRACTOR may be correcting, removing, or replacing Defective WORK in accordance with Paragraph 13.6, but the CONTRACTOR's liabilities under this Agreement shall not be deemed limited in any way to the insurance coverage required.
- B. All insurance required by the Contract Documents to be purchased and maintained by the CONTRACTOR shall be obtained from insurance companies that are duly licensed or authorized in the State of Alaska to issue insurance policies for the limits and coverages so required. Such insurance companies shall have a current Best's Rating of at least an "A" (Excellent) general policy holder's rating and a Class VII financial size category and shall also meet such additional requirements and qualifications as may be provided in the Supplementary General Conditions.
- C. The CONTRACTOR shall furnish the OWNER with certificates showing the type, amount, class of operations covered, effective dates and dates of expiration of policies. All of the policies of insurance so required to be purchased and maintained (or the certificates or other evidence thereof) shall contain a provision or endorsement that the coverage afforded will not be cancelled, reduced in coverage, or renewal refused until at least 30 days' prior written notice has been given to the OWNER by certified mail. All such insurance required herein (except for Workers' Compensation and Employer's Liability) shall name the OWNER, its Consultants and subconsultants and their officers, directors, agents, and employees as "additional insureds" under the policies. The CONTRACTOR shall purchase and maintain the following insurance:
 - 1. Workers' Compensation and Employer's Liability. This insurance shall protect the CONTRACTOR against all claims under applicable state workers' compensation laws. The CONTRACTOR shall also be protected against claims for injury, disease, or death of employees which, for any reason, may not fall within the provisions of a Workers' Compensation law. This policy shall include an "all states" endorsement. The CONTRACTOR shall require each Subcontractor similarly to provide Workers' Compensation Insurance for all of the latter's employees to be engaged in such work unless such employees are covered by the protection afforded by the CONTRACTOR's Workers' Compensation Insurance. In case any

SECTION 00700 - GENERAL CONDITIONS

class of employees is not protected, under the Workers' Compensation Statute, the CONTRACTOR shall provide and shall cause each subcontractor to provide adequate employer's liability insurance for the protection of such of its employees as are not otherwise protected.

2. Commercial General Liability. This insurance shall be written in comprehensive form and shall protect the CONTRACTOR against all claims arising from injuries to persons other than its employees or damage to property of the OWNER or others arising out of any act or omission of the CONTRACTOR or its agents, employees, or Subcontractors. The policy shall contain no exclusions for any operations within the scope of this contract.
3. Comprehensive Automobile Liability. This insurance shall be written in comprehensive form and shall protect the CONTRACTOR against all claims for injuries to members of the public and damage to property of others arising from the use of motor vehicles, and shall cover operation on or off the site of all motor vehicles licensed for highway use, whether they are owned, non-owned, or hired. Coverage for hired motor vehicles should include endorsement covering liability assumed under this contract.
4. Subcontractor's Public Liability and Property Damage Insurance and Vehicle Liability Insurance. The CONTRACTOR shall either require each of its Subcontractors to procure and to maintain Subcontractor's Commercial General Liability and Property Damage Insurance and Vehicle Liability Insurance of the type and in the amounts specified in the Supplementary General Conditions or insure the activities of its subcontractors in the CONTRACTOR's own policy, in like amount.
5. Builder's Risk. This insurance shall be of the "all risks" type, shall be written in completed value form, and shall protect the CONTRACTOR, the OWNER, and the ARCHITECT, against risks of damage to buildings, structures, and materials and equipment. The amount of such insurance shall be not less than the insurable value of the WORK at completion. Builder's risk insurance shall provide for losses to be payable to the CONTRACTOR and the OWNER, as their interests may appear. The policy shall contain a provision that in the event of payment for any loss under the coverage provided, the insurance company shall have no rights of recovery against the CONTRACTOR, the OWNER, and the ARCHITECT. The Builder's Risk policy shall insure against all risks of direct physical loss or damage to property from any external cause including flood and earthquake. Allowable exclusions, if any, shall be as specified in the Supplementary General Conditions.

ARTICLE 6 CONTRACTOR'S RESPONSIBILITIES

6.1 SUPERVISION AND SUPERINTENDENCE

- A. The CONTRACTOR shall supervise, inspect, and direct the WORK competently and efficiently, devoting such attention thereto and applying such skills and expertise as may be necessary to perform the WORK in accordance with the Contract Documents. The CONTRACTOR shall be solely responsible for the means, methods, techniques, sequences, and procedures of construction and safety precautions and programs incidental thereto. The CONTRACTOR shall be responsible to see that the completed WORK complies accurately with the Contract Documents.
- B. The CONTRACTOR shall designate in writing and keep on the work site at all times during its progress a technically qualified, English-speaking superintendent, who is an employee of the CONTRACTOR and who shall not be replaced without written notice to the OWNER and the

SECTION 00700 - GENERAL CONDITIONS

ARCHITECT. The superintendent will be the CONTRACTOR's representative at the site and shall have authority to act on behalf of the CONTRACTOR. All communications given to the superintendent shall be as binding as if given to the CONTRACTOR. The CONTRACTOR shall issue all its communications to the OWNER through the ARCHITECT and the ARCHITECT only.

- C. The CONTRACTOR's superintendent shall be present at the site of the WORK at all times while WORK is in progress. Failure to observe this requirement shall be considered suspension of the WORK by the CONTRACTOR until such time as such superintendent is again present at the site.

6.2 LABOR, MATERIALS, AND EQUIPMENT

- A. The CONTRACTOR shall provide competent, suitably qualified personnel to survey and lay out the WORK and perform construction as required by the Contract Documents. The CONTRACTOR shall furnish, erect, maintain, and remove the construction plant and any temporary works as may be required. The CONTRACTOR shall at all times maintain good discipline and order at the site. Except in connection with the safety or protection of persons or the WORK or property at the site or adjacent thereto, and except as otherwise indicated in the Contract Documents, all WORK at the site shall be performed during regular working hours, and the CONTRACTOR will not permit overtime WORK or the performance of WORK on Saturday, Sunday, or any legal holiday without the OWNER's written consent. The CONTRACTOR shall apply for this consent through the ARCHITECT.
- B. Except as otherwise provided in this Paragraph, the CONTRACTOR shall receive no additional compensation for overtime WORK, i.e., work in excess of 8 hours in any one calendar day or 40 hours in any one calendar week, even though such overtime WORK may be required under emergency conditions and may be ordered by the ARCHITECT in writing. Additional compensation will be paid the CONTRACTOR for overtime WORK only in the event extra WORK is ordered by the ARCHITECT and the Change Order specifically authorizes the use of overtime WORK and then only to such extent as overtime wages are regularly being paid by the CONTRACTOR for overtime WORK of a similar nature in the same locality.
- C. All costs of inspection and testing performed during overtime WORK by the CONTRACTOR which is allowed solely for the convenience of the CONTRACTOR shall be borne by the CONTRACTOR. The ARCHITECT shall have the authority to deduct the cost of all such inspection and testing from any partial payments otherwise due to the CONTRACTOR.
- D. Unless otherwise specified in the Contract Documents, the CONTRACTOR shall furnish and assume full responsibility for all materials, equipment, labor, transportation, construction equipment and machinery, tools, appliances, fuel, power, light, heat, telephone, water, sanitary facilities, and all other facilities and incidentals necessary for the furnishing, performance, testing, start-up, and completion of the WORK.
- E. All materials and equipment to be incorporated into the WORK shall be of good quality and new, except as otherwise provided in the Contract Documents. All warranties and guarantees specifically called for by the Specifications shall expressly run to the benefit of the OWNER. If required by the ARCHITECT, the CONTRACTOR shall furnish satisfactory evidence (including reports of required tests) as to the kind and quality of materials and equipment. All materials and equipment shall be applied, installed, connected, erected, used, cleaned, and conditioned in accordance with the instructions of the applicable Supplier except as otherwise provided in the Contract Documents; but no provisions of any such instructions will be effective to assign to the ARCHITECT, or any of the

SECTION 00700 - GENERAL CONDITIONS

Architect's of Record consultants, agents, or employees, any duty or authority to supervise or direct the furnishing or performance of the WORK or any duty or authority to undertake responsibility contrary to the provisions of Paragraphs 9.9C and 9.9D.

- F. The CONTRACTOR shall at all times employ sufficient labor and equipment for prosecuting the several classes of WORK to full completion in the manner and time set forth in and required by these specifications. All workers shall have sufficient skill and experience to properly perform the WORK assigned to them. Workers engaged in special WORK, or skilled WORK, shall have sufficient experience in such WORK and in the operation of the equipment required to perform all WORK, properly and satisfactorily.
 - G. Any person employed by the CONTRACTOR or by any SUBCONTRACTOR who, in the opinion of the ARCHITECT, does not perform the WORK in a proper and skillful manner, or is intemperate or disorderly shall, at the written request of the ARCHITECT, be removed forthwith by the CONTRACTOR or Subcontractor employing such person, and shall not be employed again in any portion of the WORK without the approval of the ARCHITECT. Should the CONTRACTOR fail to remove such person or persons as required above, or fail to furnish suitable and sufficient personnel for the proper prosecution of the WORK, the ARCHITECT may suspend the WORK by written notice until such orders are complied with.
- 6.3 ADJUSTING PROGRESS SCHEDULE. The CONTRACTOR shall submit monthly updates of the progress schedule to the ARCHITECT for acceptance in accordance with the provisions in Section 01300 - CONTRACTOR Submittals in the General Requirements.
- 6.4 SUBSTITUTES OR "OR-EQUAL" ITEMS. The CONTRACTOR shall submit proposed substitutes or "or-equal" items in accordance with the provisions in Section 01300 - CONTRACTOR Submittals in the General Requirements.
- 6.5 CONCERNING SUBCONTRACTORS, SUPPLIERS, AND OTHERS. The CONTRACTOR shall be responsible to the OWNER and the ARCHITECT of Record for the acts and omissions of its subcontractors and their employees to the same extent as CONTRACTOR is responsible for the acts and omissions of its own employees. Nothing contained in this Paragraph shall create any contractual relationship between any subcontractor and the OWNER or the ARCHITECT nor relieve the CONTRACTOR of any liability or obligation under the contract.
- 6.6 PERMITS
- A. Unless otherwise provided in the Supplementary General Conditions, the CONTRACTOR shall obtain and pay for all construction permits and licenses from the agencies having jurisdiction, including the furnishing of insurance and Bonds if required by such agencies. The enforcement of such requirements under this contract shall not be made the basis for claims for additional compensation. The OWNER shall assist the CONTRACTOR, when necessary, in obtaining such permits and licenses. The CONTRACTOR shall pay all governmental charges and inspection fees necessary for the prosecution of the WORK, which are applicable at the time of opening of Bids. The CONTRACTOR shall pay all charges of utility owners for connections to the WORK.
 - B. These Contract Documents may require that the WORK be performed within the conditions and/or requirements of local, state and/or federal permits. These permits may be bound within the Contract Documents, included within the Contract Documents by reference, or included as part of the WORK, as designated in this Section. The CONTRACTOR is responsible for completing the WORK required

SECTION 00700 - GENERAL CONDITIONS

for compliance with all permit requirements; this WORK is incidental to other items in the Contract Documents. Any reference to the PERMITTEE in the permits shall mean the CONTRACTOR. If any permits were acquired by the OWNER, this action was done to expedite the start of construction. If the CONTRACTOR does not complete the WORK within the specified permit window, the CONTRACTOR shall be responsible for the permit extension, and for completing any additional requirements placed upon the permit.

- 6.7 **PATENT FEES AND ROYALTIES.** The CONTRACTOR shall pay all license fees and royalties and assume all costs incident to the use in the performance of the WORK or the incorporation in the WORK of any invention, design, process, product, software or device which is the subject of patent rights or copyrights held by others. If a particular invention, design, process, product, or device is specified in the Contract Documents for use in the performance of the WORK and if to the actual knowledge of the OWNER or the Architect of Record its use is subject to patent rights or copyrights calling for the payment of any license fee or royalty to others, the existence of such rights shall be disclosed by the OWNER in the Contract Documents. The CONTRACTOR shall indemnify, defend and hold harmless the OWNER and the Architect of Record and anyone directly or indirectly employed by either of them from and against all claims, damages, losses, and expenses (including attorneys' fees and court costs) arising out of any infringement of patent rights or copyrights incident to the use in the performance of the WORK or resulting from the incorporation in the WORK of any invention, design, process, product, or device not specified in the Contract Documents, and shall defend all such claims in connection with any alleged infringement of such rights.
- 6.8 **LAWS AND REGULATIONS.** The CONTRACTOR shall observe and comply with all federal, state, and local laws, ordinances, codes, orders, and regulations which in any manner affect those engaged or employed on the WORK, the materials used in the WORK, or the conduct of the WORK. If any discrepancy or inconsistency should be discovered in this contract in relation to any such law, ordinance, code, order, or regulation, the CONTRACTOR shall report the same in writing to the ARCHITECT. The CONTRACTOR shall indemnify, defend, and hold harmless the OWNER, the Architect of Record, and their officers, agents, and employees against all claims or liability arising from violation of any such law, ordinance, code, order, or regulation, whether by CONTRACTOR or by its employees, Subcontractors, or third parties. Any particular law or regulation specified or referred to elsewhere in the Contract Documents shall not in any way limit the obligation of the CONTRACTOR to comply with all other provisions of federal, state, and local laws and regulations.
- 6.9 **TAXES.** The CONTRACTOR shall pay all sales, consumer, use, and other similar taxes required to be paid by the CONTRACTOR in accordance with the Laws and Regulations of the place of the Project which are applicable during the performance of the WORK.
- 6.10 **USE OF PREMISES.** The CONTRACTOR shall confine construction equipment, the storage of materials and equipment, and the operations of workers to (1) the Project site, (2) the land and areas identified in and permitted by the Contract Documents, and (3) the other land and areas permitted by Laws and Regulations, rights-of-way, permits, leases and easements. The CONTRACTOR shall assume full responsibility for any damage to any such land or area, or to the owner or occupant thereof or of any land or areas contiguous thereto, resulting from the performance of the WORK. Should any claim be made against the OWNER or the Architect of Record by any such owner or occupant because of the performance of the WORK, the CONTRACTOR shall promptly attempt to settle with such other party by agreement or otherwise resolve the claim through litigation. The CONTRACTOR shall, to the fullest extent permitted by Laws and Regulations, indemnify, defend, and hold the OWNER and the Architect of Record harmless from and against all claims, damages, losses, and expenses (including, but not limited to, fees of Architect's of Records attorneys, and other

SECTION 00700 - GENERAL CONDITIONS

professionals and court costs) arising directly, indirectly, or consequentially out of any action, legal or equitable, brought by any such owner or occupant against the OWNER, the Architect of Record, their consultants, sub-consultants, and the officers, directors, employees and agents of each and any of them to the extent caused by or based upon the CONTRACTOR's performance of the WORK.

6.11 SAFETY AND PROTECTION

- A. The CONTRACTOR shall be responsible for initiating, maintaining, and supervising all safety precautions and programs in connection with the WORK. The CONTRACTOR shall take all necessary precautions for the safety of, and shall provide the necessary protection to prevent damage, injury or loss to:
 - 1. all employees on the WORK and other persons and organizations who may be affected thereby;
 - 2. all the WORK and materials and equipment to be incorporated therein, whether in storage on or off the site; and
 - 3. other property at the site or adjacent thereto, including trees, shrubs, lawns, walks, pavements, roadways, structures, and utilities not designated for removal, relocation, or replacement in the course of construction.
- B. The CONTRACTOR shall comply with all applicable Laws and Regulations whether referred to herein or not) of any public body having jurisdiction for the safety of persons or property or to protect them from damage, injury, or loss and shall erect and maintain all necessary safeguards for such safety and protection. The CONTRACTOR shall notify owners of adjacent property and utilities when prosecution of the WORK may affect them, and shall cooperate with them in the protection, removal, relocation, and replacement of their property.
- C. The CONTRACTOR shall designate a qualified and experienced safety representative at the site whose duties and responsibilities shall be the prevention of accidents and the maintaining and supervising of safety precautions and program.
- D. Materials that contain hazardous substances or mixtures may be required on the WORK. A Material Safety Data Sheet (MSDS) shall be requested by the CONTRACTOR from the manufacturer of any hazardous product used.
- E. Material usage shall be accomplished with strict adherence to all safety requirements and all manufacturer's warnings and application instructions listed on the Material Safety Data Sheet and on the product container label.
- F. The CONTRACTOR shall be responsible for coordinating communications on any exchange of Material Safety Data Sheets or other hazardous material information that is required to be made available to, or exchanged between, or among, employers at the site in accordance with Laws or Regulations.
- G. The CONTRACTOR shall notify the ARCHITECT if it considers a specified product or its intended usage to be unsafe. This notification must be given to the ARCHITECT prior to the product being ordered, or if provided by some other party, prior to the product being incorporated in the WORK.

SECTION 00700 - GENERAL CONDITIONS

6.12 SHOP DRAWINGS AND SAMPLES

- A. After checking and verifying all field measurements and after complying with applicable procedures specified in the General Requirements, the CONTRACTOR shall submit to the ARCHITECT for review, all Shop Drawings in accordance with Section 01300 - CONTRACTOR Submittals in the General Requirements.
- B. The CONTRACTOR shall also submit to the ARCHITECT for review all samples in accordance with Section 01300 - CONTRACTOR Submittals in the General Requirements.
- C. Before submittal of each Shop Drawing or sample, the CONTRACTOR shall have determined and verified all quantities, dimensions, specified performance criteria, installation requirements, materials, catalog numbers, and similar data with respect thereto and reviewed or coordinated each Shop Drawing or sample with other Shop Drawings and samples and with the requirements of the WORK and the Contract Documents.

6.13 CONTINUING THE WORK. The CONTRACTOR shall carry on the WORK and adhere to the progress schedule during all disputes or disagreements with the OWNER. No WORK shall be delayed or postponed pending resolution of any disputes or disagreements, except as the CONTRACTOR and the OWNER may otherwise agree in writing.

6.14 INDEMNIFICATION

- A. To the fullest extent permitted by Laws and Regulations, the CONTRACTOR shall indemnify, defend, and hold harmless the OWNER, the Architect of Record, their consultants, sub-consultants and the officers, directors, employees, and agents of each and any of them, against and from all claims and liability arising under, by reason of or incidentally to the contract or any performance of the WORK, but not from the sole negligence or willful misconduct of the OWNER, and the Architect of Record. Such indemnification by the CONTRACTOR shall include but not be limited to the following:
 - 1. Liability or claims resulting directly or indirectly from the negligence or carelessness of the CONTRACTOR, its employees, or agents in the performance of the WORK, or in guarding or maintaining the same, or from any improper materials, implements, or appliances used in its construction, or by or on account of any act or omission of the CONTRACTOR, its employees, agents, or third parties;
 - 2. Liability or claims arising directly or indirectly from bodily injury, occupational sickness or disease, or death of the CONTRACTOR's or Subcontractor's own employees engaged in the WORK resulting in actions brought by or on behalf of such employees against the OWNER, or the Architect of Record;
 - 3. Liability or claims arising directly or indirectly from or based on the violation of any law, ordinance, regulation, order, or decree, whether by the CONTRACTOR, its employees, or agents;
 - 4. Liability or claims arising directly or indirectly from the use or manufacture by the CONTRACTOR, its employees, or agents in the performance of this contract of any copyrighted or non-copyrighted composition, secret process, patented or non-patented invention, computer software, article, or appliance, unless otherwise specifically stipulated in this contract.

SECTION 00700 - GENERAL CONDITIONS

5. Liability or claims arising directly or indirectly from the breach of any warranties, whether express or implied, made to the ARCHITECT, OWNER or any other parties by the CONTRACTOR, its employees, or agents;
 6. Liabilities or claims arising directly or indirectly from the willful or criminal misconduct of the CONTRACTOR, its employees, or agents; and,
 7. Liabilities or claims arising directly or indirectly from any breach of the obligations assumed herein by the CONTRACTOR.
- B. The CONTRACTOR shall reimburse the OWNER and the Architect of Record for all costs and expenses, (including but not limited to fees and charges of Architects of Record, attorneys, and other professionals and court costs including all costs of appeals) incurred by the OWNER, and the Architect of Record in enforcing the provisions of this Paragraph 6.14.
- C. The indemnification obligation under this Paragraph 6.14 shall not be limited in any way by any limitation of the amount or type of damages, compensation, or benefits payable by or for the CONTRACTOR or any such Subcontractor or other person or organization under workers' compensation acts, disability benefit acts, or other employee benefit acts.
- 6.15 **CONTRACTOR'S DAILY REPORTS.** The CONTRACTOR shall complete a daily report indicating total manpower for each construction trade, major equipment on site, each Subcontractor's manpower, weather conditions, etc., involved in the performance of the WORK. The daily report shall be completed on forms provided by the ARCHITECT and shall be submitted to the ARCHITECT at the conclusion of each WORK day. The report should comment on the daily progress and status of the WORK within each major component of the WORK. These components will be decided by the ARCHITECT. The CONTRACTOR shall record the name, affiliation, time of arrival and departure, and reason for visit for all visitors to the location of the WORK.
- 6.16 **ASSIGNMENT OF CONTRACT.** The CONTRACTOR shall not assign, sublet, sell, transfer, or otherwise dispose of the contract or any portion thereof, or its right, title, or interest therein, or obligations thereunder, without the written consent of the OWNER except as imposed by law. If the CONTRACTOR violates this provision, the contract may be terminated at the option of the OWNER. In such event, the OWNER shall be relieved of all liability and obligations to the CONTRACTOR and to its assignee or transferee, growing out of such termination.
- 6.17 **CONTRACTOR'S RESPONSIBILITY FOR UTILITY PROPERTY AND SERVICES.** It is understood that any turn-on, or turn-off line locates and any other WORK or assistance necessary by the CBJ Water Utilities Division, will be at the CONTRACTOR's expense unless otherwise stated in the bid documents. All cost must be agreed to prior to any related actions, and will be considered incidental to the Project cost. Billing to the CONTRACTOR will be direct from the CBJ Water Utilities Division.
- 6.18 **OPERATING WATER SYSTEM VALVES**
- A. The CONTRACTOR shall submit a written request, to the ARCHITECT, for approval to operate any valve on any in-service section of the CBJ water system. The request must be submitted at least 24-hours prior to operating any valves. The CBJ Water Utilities Division reserves the right to approve or deny the request. The request shall specifically identify each valve to be operated, the time of operation, and the operation to be performed. The CONTRACTOR shall obtain the written approval of the ARCHITECT for any scheduled operation before operating any valve.

SECTION 00700 - GENERAL CONDITIONS

- B. The CONTRACTOR shall be responsible for all damages, both direct and consequential, to the OWNER or any other party, caused by unauthorized operation of any valve of the CBJ water system.
- 6.19 CONTRACTOR'S WORK SCHEDULE LIMITATIONS. Construction of Buildings and Projects. It is unlawful to operate any pile driver, power shovel, pneumatic hammer, derrick, power hoist, or similar heavy construction equipment before 7:00 a.m. or after 10:00 p.m., Monday through Friday, or before 9:00 a.m. or after 10:00 p.m., Saturday and Sunday, unless a permit shall first be obtained from the City and Borough Building Official. Such permit shall be issued by the Building Official only upon a determination that such operation during hours not otherwise permitted hereunder is necessary and will not result in unreasonable disturbance to surrounding residents.

ARTICLE 7 OTHER WORK

7.1 RELATED WORK AT SITE

- A. The OWNER may perform other work related to the Project at the site by the OWNER's own forces, have other work performed by utility owners, or let other direct contracts therefor which may contain General Conditions similar to these. If the fact that such other work is to be performed was not noted in the Contract Documents, written notice thereof will be given to the CONTRACTOR prior to starting any such other work.
 - B. The CONTRACTOR shall afford each other contractor who is a party to such a direct contract and each utility owner (or the OWNER, if the OWNER is performing the additional work with the OWNER's employees) proper and safe access to the site and a reasonable opportunity for the introduction and storage of materials and equipment and the execution of such work, and shall properly connect and coordinate with their WORK. The CONTRACTOR shall do all cutting, fitting, and patching of the WORK that may be required to make its several parts come together properly and integrate with such other work. The CONTRACTOR shall not endanger any work of others by cutting, excavating, or otherwise altering their work and will only cut or alter their work with the written consent of the ARCHITECT and the others whose work will be affected.
 - C. If the proper execution or results of any part of the CONTRACTOR's WORK depends upon the work of any such other contractor or utility owner (or OWNER), the CONTRACTOR shall inspect and report to the ARCHITECT in writing any delays, defects, or deficiencies in such other work that render it unavailable or unsuitable for such proper execution and results. The CONTRACTOR's failure to report such delays, defects, or deficiencies will constitute an acceptance of the other work as fit and proper for integration with the CONTRACTOR's WORK except for latent or nonapparent defects and deficiencies in the other work.
- 7.2 COORDINATION. If the OWNER contracts with others for the performance of other work on the Project at the site, the person or organization who will have authority and responsibility for coordination of the activities among the various prime contractors will be identified in the Supplementary General Conditions, and the specific matters to be covered by such authority and responsibility will be itemized and the extent of such authority and responsibilities will be provided in the Supplementary General Conditions.

SECTION 00700 - GENERAL CONDITIONS

ARTICLE 8 OWNER'S RESPONSIBILITIES

8.1 COMMUNICATIONS

- A. The OWNER shall issue all its communications to the CONTRACTOR through the ARCHITECT.
- B. The CONTRACTOR shall issue all its communications to the OWNER through the ARCHITECT.

8.2 **PAYMENTS.** The OWNER shall make payments to the CONTRACTOR as provided in Paragraphs 14.5, 14.8, 14.9 and 14.10.

8.3 **LANDS, EASEMENTS, AND SURVEYS.** The OWNER's duties in respect of providing lands and easements and providing surveys to establish reference points are set forth in Paragraphs 4.1 and 4.5.

8.4 **CHANGE ORDERS.** The OWNER shall execute Change Orders as indicated in Paragraph 10.1F.

8.5 **INSPECTIONS AND TESTS.** The OWNER's responsibility in respect of inspections, tests, and approvals is set forth in Paragraph 13.3.

8.6 **SUSPENSION OF WORK.** In connection with the OWNER's right to stop WORK or suspend WORK, see Paragraphs 13.4 and 15.1.

8.7 **TERMINATION OF AGREEMENT.** Paragraphs 15.2 and 15.3 deal with the OWNER's right to terminate services of the CONTRACTOR.

ARTICLE 9 ARCHITECT'S STATUS DURING CONSTRUCTION

9.1 **OWNER'S REPRESENTATIVE.** The ARCHITECT will be the OWNER's representative during the construction period. The duties and responsibilities and the limitations of authority of the ARCHITECT as the OWNER's representative during construction are set forth in the Contract Documents.

9.2 **VISITS TO SITE.** The ARCHITECT will make visits to the site during construction to observe the progress and quality of the WORK and to determine, in general, if the WORK is proceeding in accordance with the Contract Documents. Exhaustive or continuous on-site inspections to check the quality or quantity of the WORK will not be required of the ARCHITECT. The ARCHITECT will not, during such visits, or as a result of such observations of the CONTRACTOR's WORK in progress, supervise, direct, or have control over the CONTRACTOR's WORK.

9.3 **PROJECT REPRESENTATION.** The ARCHITECT may furnish an Inspector to assist in observing the performance of the WORK. The duties, responsibilities, and limitations of authority of any such Inspector and assistants will be as provided in the Supplementary General Conditions.

9.4 **CLARIFICATIONS AND INTERPRETATIONS.** The ARCHITECT will issue with reasonable promptness such written clarifications or interpretations of the requirements of the Contract Documents (in the form of Drawings or otherwise) as the ARCHITECT may determine necessary, which shall be consistent with or reasonably inferable from the overall intent of the Contract Documents.

SECTION 00700 - GENERAL CONDITIONS

- 9.5 AUTHORIZED VARIATIONS IN WORK. The ARCHITECT may authorize variations in the WORK from the requirements of the Contract Documents. These may be accomplished by a Field Order and will require the CONTRACTOR to perform the WORK involved in a manner that minimizes the impact to the WORK and the contract completion date. If the CONTRACTOR believes that a Field Order justifies an increase in the Contract Price or an extension of the Contract Time, the CONTRACTOR may make a claim therefor as provided in Article 11 or 12.
- 9.6 REJECTING OR ACCEPTING DEFECTIVE WORK. The ARCHITECT will have authority to reject or accept WORK which the ARCHITECT believes to be defective and will also have authority to require special inspection or testing of the WORK as provided in Paragraph 13.3G, whether or not the WORK is fabricated, installed, or completed.
- 9.7 CONTRACTOR SUBMITTALS, CHANGE ORDERS, AND PAYMENTS
- A. In accordance with the procedures set forth in the General Requirements, the ARCHITECT will review all CONTRACTOR submittals, including Shop Drawings, samples, substitutes, or "or equal" items, etc., in order to determine if the items covered by the submittals will, after installation or incorporation in the WORK, conform to the requirements of the Contract Documents and be compatible with the design concept of the completed Project as a functioning whole as indicated by the Contract Documents. The ARCHITECT's review will not extend to means, methods, techniques, sequences or procedures of construction or to safety precautions or programs incident thereto.
 - B. In connection with the ARCHITECT's responsibilities as to Change Orders, see Articles 10, 11, and 12.
 - C. In connection with the ARCHITECT's responsibilities in respect of Applications for Payment, see Article 14.
- 9.8 DECISIONS ON DISPUTES
- A. The ARCHITECT will be the initial interpreter of the requirements of the Contract Documents and judge of the acceptability of the WORK thereunder. Claims, disputes, and other matters relating to the acceptability of the WORK; the interpretation of the requirements of the Contract Documents pertaining to the performance of the WORK; and those claims under Articles 11 and 12 in respect to changes in the Contract Price or Contract Time will be referred initially to the ARCHITECT in writing with a request for formal decision in accordance with this paragraph, which the ARCHITECT will render in writing within 30 days of receipt of the request. Written notice of each such claim, dispute, and other matter will be delivered by the CONTRACTOR to the ARCHITECT promptly (but in no event later than 30 days) after the occurrence of the event giving rise thereto. Written supporting data will be submitted to the ARCHITECT within 60 days after such occurrence unless the ARCHITECT allows an additional period of time to ascertain more accurate data in support of the claim.
 - B. The rendering of a decision by the ARCHITECT with respect to any such claim, dispute, or other matter (except any which have been waived by the making or acceptance of final payment as provided in Paragraph 14.12) will be a condition precedent to any exercise by the OWNER or the CONTRACTOR of such rights or remedies as either may otherwise have under the Contract Documents or by Law or Regulations in respect of any such claim, dispute, or other matter.

SECTION 00700 - GENERAL CONDITIONS

9.9 LIMITATION ON ARCHITECT'S RESPONSIBILITIES

- A. Neither the ARCHITECT's authority to act under this Article or other provisions of the Contract Documents nor any decision made by the ARCHITECT in good faith either to exercise or not exercise such authority shall give rise to any duty or responsibility of the ARCHITECT to the CONTRACTOR, any Subcontractor, any Supplier, any surety for any of them, or any other person or organization performing any of the WORK.
- B. Whenever in the Contract Documents the terms "as ordered," "as directed," "as required," "as allowed," "as reviewed," "as approved," or terms of like effect or import are used, or the adjectives "reasonable," "suitable," "acceptable," "proper," or "satisfactory" or adjectives of like effect or import are used to describe a requirement, direction, review, or judgment of the ARCHITECT as to the WORK, it is intended that such requirement, direction, review, or judgment will be solely to evaluate the WORK for compliance with the requirements of the Contract Documents, and conformance with the design concept of the completed Project as a functioning whole as indicated by the Contract Documents, unless there is a specific statement indicating otherwise. The use of any such term or adjective shall not be effective to assign to the ARCHITECT any duty or authority to supervise or direct the performance of the WORK or any duty or authority to undertake responsibility contrary to the provisions of Paragraph 9.9C or 9.9D.
- C. The ARCHITECT will not supervise, direct, control, or have authority over or be responsible for the CONTRACTOR's means, methods, techniques, sequences, or procedures of construction, or the safety precautions and programs incident thereto, or for any failure of the CONTRACTOR to comply with Laws and Regulations, applicable to the performance of the WORK. The ARCHITECT will not be responsible for the CONTRACTOR's failure to perform the WORK in accordance with the Contract Documents.
- D. The ARCHITECT will not be responsible for the acts or omissions of the CONTRACTOR nor of any Subcontractor, Supplier, or any other person or organization performing any of the WORK.

ARTICLE 10 CHANGES IN THE WORK

10.1 GENERAL

- A. Without invalidating the Agreement and without notice to any surety, the OWNER may at any time or from time to time, order additions, deletions, or revisions in the WORK; these will be authorized by a written Field Order and/or a Change Order issued by the ARCHITECT.
- B. If the CONTRACTOR believes that it is entitled to an increase or decrease in the Contract Price, or an extension or shortening in the Contract Time as the result of a Field Order, a claim may be made as provided in Articles 11 and 12.
- C. If the OWNER and CONTRACTOR agree on the value of any WORK, or the amount of Contract Time that should be allowed as a result of a Field Order, upon receiving written notice from the ARCHITECT, the CONTRACTOR shall proceed so as to minimize the impact on and delays to the WORK pending the issuance of a Change Order.
- D. If the OWNER and the CONTRACTOR are unable to agree as to the extent, if any, of an increase or decrease in the Contract Price or an extension or shortening of the Contract Time that should be

SECTION 00700 - GENERAL CONDITIONS

allowed as a result of a Field Order, the ARCHITECT can direct the CONTRACTOR to proceed on the basis of Time and Materials so as to minimize the impact on and delays to the WORK, and a claim may be made therefor as provided in Articles 11 and 12.

- E. The CONTRACTOR shall not be entitled to an increase in the Contract Price nor an extension of the Contract Time with respect to any WORK performed that is not required by the Contract Documents as amended, modified, supplemented by Change Order, except in the case of an emergency and except in the case of uncovering WORK as provided in Paragraph 13.3G.
- F. The OWNER and the CONTRACTOR shall execute appropriate Change Orders covering:
 - 1. changes in the WORK which are ordered by the OWNER pursuant to Paragraph 10.1A;
 - 2. changes required because of acceptance of Defective WORK under Paragraph 13.7;
 - 3. changes in the Contract Price or Contract Time which are agreed to by the parties; or
 - 4. changes in the Contract Price or Contract Time which embody the substance of any written decision rendered by the ARCHITECT pursuant to Paragraph 9.8.
- G. If notice of any change is required by the provisions of any Bond to be given to a surety, the giving of any such notice will be the CONTRACTOR's responsibility, and the amount of each applicable Bond shall be adjusted accordingly.

10.2 ALLOWABLE QUANTITY VARIATIONS

- A. In the event of an increase or decrease in bid item quantity of a unit price contract, the total amount of WORK actually done or materials or equipment furnished shall be paid for according to the unit price established for such WORK under the Contract Documents, wherever such unit price has been established; provided, that an adjustment in the Contract Price may be made for changes which result in an increase or decrease in excess of 25% of the estimated quantity of any major item of the WORK. Major Item is defined as any bid item amount that is ten percent (10%) or more of the total contract amount.
- B. In the event a part of the WORK is to be entirely eliminated and no lump sum or unit price is named in the Contract Documents to cover such eliminated WORK, the price of the eliminated WORK shall be agreed upon in writing by the OWNER and the CONTRACTOR. If the OWNER and the CONTRACTOR fail to agree upon the price of the eliminated WORK, said price shall be determined in accordance with the provisions of Article 11.

ARTICLE 11 CHANGE OF CONTRACT PRICE

11.1 GENERAL

- A. The Contract Price constitutes the total compensation payable to the CONTRACTOR for performing the WORK. All duties, responsibilities, and obligations assigned to or undertaken by the CONTRACTOR to complete the WORK shall be at its expense without change in the Contract Price.
- B. The Contract Price may only be changed by a Change Order. Any claim for an increase in the Contract Price shall be based on written notice delivered by the CONTRACTOR to the ARCHITECT promptly (but in no event later than 30 days) after the start of the occurrence or the event giving rise

SECTION 00700 - GENERAL CONDITIONS

to the claim and stating the general nature of the claim. Notice of the amount of the claim with supporting data shall be delivered within 60 days after such occurrence (unless the ARCHITECT allows an additional period of time to ascertain more accurate data in support of the claim) and shall be accompanied by the CONTRACTOR's written statement that the amount claimed covers all known amounts (direct, indirect, and consequential) to which the CONTRACTOR is entitled as a result of said occurrence or event. All claims for adjustment in the Contract Price shall be determined by the ARCHITECT in accordance with Paragraph 9.8A if the OWNER and the CONTRACTOR cannot otherwise agree on the amount involved. No claim for an adjustment in the Contract Price will be valid if not submitted in accordance with this Paragraph 11.1B.

- C. The value of any WORK covered by a Change Order or of any claim for an increase or decrease in the Contract Price shall be determined in one of the following ways:
1. Where the WORK involved is covered by unit prices contained in the Contract Documents, by application of unit prices to the quantities of the items involved.
 2. By mutual acceptance of a lump sum, which may include an allowance for overhead and profit not necessarily in accordance with Paragraph 11.4.
 3. On the basis of the "Cost of WORK" (determined as provided in Paragraphs 11.3) plus a CONTRACTOR's fee for overhead and profit (determined as provided in Paragraph 11.4).

11.2 COSTS RELATING TO WEATHER. The CONTRACTOR shall have no claims against the OWNER for damages for any injury to WORK, materials, or equipment, resulting from the action of the elements. If, however, in the opinion of the ARCHITECT, the CONTRACTOR has made all reasonable efforts to protect the materials, equipment and WORK, the CONTRACTOR may be granted a reasonable extension of Contract Time to make proper repairs, renewals, and replacements of the WORK, materials, or equipment.

11.3 COST OF WORK (BASED ON TIME AND MATERIALS)

- A. General. The term "Cost of WORK" means the sum of all costs necessarily incurred and paid by the CONTRACTOR for labor, materials, and equipment in the proper performance of extra WORK. Except as otherwise may be agreed to in writing by the OWNER, such costs shall be in amounts no higher than those prevailing in the locality of the Project; shall include only the following items, and shall not include any of the costs itemized in Paragraph 11.5 EXCLUDED COSTS.
- B. Labor. The costs of labor will be the actual cost for wages prevailing for each craft or type of workers performing the extra WORK at the time the extra WORK is done, plus employer payments of payroll taxes, worker's compensation insurance, liability insurance, health and welfare, pension, vacation, apprenticeship funds, and other direct costs resulting from Federal, State or local laws, as well as assessments or benefits required by lawful collective bargaining agreements. Labor costs for equipment operators and helpers shall be paid only when such costs are not included in the invoice for equipment rental. The labor costs for forepersons shall be proportioned to all of their assigned WORK and only that applicable to extra WORK shall be paid. Non-direct labor costs including superintendence shall be considered part of the mark-up set out in paragraph 11.4.
- C. Materials. The cost of materials reported shall be at invoice or lowest current price at which materials are locally available and delivered to the job in the quantities involved, plus the cost of freight, delivery and storage, subject to the following:

SECTION 00700 - GENERAL CONDITIONS

1. Trade discounts available to the purchaser shall be credited to the OWNER notwithstanding the fact that such discounts may not have been taken by the CONTRACTOR.
 2. For materials secured by other than a direct purchase and direct billing to the purchaser, the cost shall be deemed to be the price paid to the actual supplier as determined by the ARCHITECT. Mark-up except for actual costs incurred in the handling of such materials will not be allowed.
 3. Payment for materials from sources owned wholly or in part by the purchaser shall not exceed the price paid by the purchaser for similar materials from said sources on extra WORK items or the current wholesale price for such materials delivered to the WORK site, whichever price is lower.
 4. If in the opinion of the ARCHITECT the cost of material is excessive, or the CONTRACTOR does not furnish satisfactory evidence of the cost of such material, then the cost shall be deemed to be the lowest current wholesale price for the quantity concerned delivered to the WORK site less trade discount. The OWNER reserves the right to furnish materials for the extra WORK and no claim shall be allowed by the CONTRACTOR for costs and profit on such materials.
- D. Equipment. The CONTRACTOR will be paid for the use of equipment at the rental rate listed for such equipment specified in the Supplementary General Conditions. Such rental rate will be used to compute payments for equipment whether the equipment is under the CONTRACTOR's control through direct ownership, leasing, renting, or another method of acquisition. The rental rate to be applied for use of each item of equipment shall be the rate resulting in the least total cost to the OWNER for the total period of use. If it is deemed necessary by the CONTRACTOR to use equipment not listed in the publication specified in the Supplementary General Conditions, an equitable rental rate for the equipment will be established by the ARCHITECT. The CONTRACTOR may furnish cost data which might assist the ARCHITECT in the establishment of the rental rate.
1. All equipment shall, in the opinion of the ARCHITECT, be in good working condition and suitable for the purpose for which the equipment is to be used.
 2. Before construction equipment is used on the extra WORK, the CONTRACTOR shall plainly stencil or stamp an identifying number thereon at a conspicuous location, and shall furnish to the ARCHITECT, in duplicate, a description of the equipment and its identifying number.
 3. Unless otherwise specified, manufacturer's ratings and manufacturer approved modifications shall be used to classify equipment for the determination of applicable rental rates. Equipment which has no direct power unit shall be powered by a unit of at least the minimum rating recommended by the manufacturer.
 4. Individual pieces of equipment or tools having a replacement value of \$200 or less, whether or not consumed by use, shall be considered to be small tools and no payment will be made therefor.
 5. Rental time will not be allowed while equipment is inoperative due to breakdowns.
 6. Equipment. Unless otherwise agreed to in writing, the CONTRACTOR will be paid for the use of equipment at the rental rate listed for such equipment specified in the current edition of the following reference publication: "Rental Rate Blue Book" available on-line at <http://www.equipmentwatch.com/rbb.htm> or contact Equipment Watch at (800) 669-3282.
- E. Equipment on the WORK Site. The rental time to be paid for equipment on the WORK site shall be the time the equipment is in productive operation on the extra WORK being performed and, in addition, shall include the time required to move the equipment to the location of the extra WORK and return it to the original location or to another location requiring no more time than that required

SECTION 00700 - GENERAL CONDITIONS

to return it to its original location; except, that moving time will not be paid if the equipment is used on other than the extra WORK, even though located at the site of the extra WORK. Loading and transporting costs will be allowed, in lieu of moving time, when the equipment is moved by means other than its own power, except that no payment will be made for loading and transporting costs when the equipment is used at the site of the extra WORK on other than the extra WORK. The following shall be used in computing the rental time of equipment on the WORK site.

1. When hourly rates are listed, any part of an hour less than 30 minutes of operation shall be considered to be 1/2-hour of operation, and any part of an hour in excess of 30 minutes will be considered one hour of operation.
 2. When daily rates are listed, any part of a day less than 4 hours operation shall be considered to be 1/2-day of operation. When owner-operated equipment is used to perform extra WORK to be paid for on a time and materials basis, the CONTRACTOR will be paid for the equipment and operator, as set forth in Paragraphs (3), (4), and (5), following.
 3. Payment for the equipment will be made in accordance with the provisions in Paragraph 11.3D, herein.
 4. Payment for the cost of labor and subsistence or travel allowance will be made at the rates paid by the CONTRACTOR to other workers operating similar equipment already on the WORK site, or in the absence of such labor, established by collective bargaining agreements for the type of worker and location of the extra WORK, whether or not the operator is actually covered by such an agreement. A labor surcharge will be added to the cost of labor described herein in accordance with the provisions of Paragraph 11.3B, herein, which surcharge shall constitute full compensation for payments imposed by state and federal laws and all other payments made to or on behalf of workers other than actual wages.
 5. To the direct cost of equipment rental and labor, computed as provided herein, will be added the allowances for equipment rental and labor as provided in Paragraph 11.4, herein.
- F. Specialty WORK. Specialty WORK is defined as that WORK characterized by extraordinary complexity, sophistication, or innovation or a combination of the foregoing attributes which are unique to the construction industry. The following shall apply in making estimates for payment for specialty WORK:
1. Any bid item of WORK to be classified as Specialty WORK shall be listed as such in the Supplementary General Conditions. Specialty WORK shall be performed by an entity especially skilled in the work to be performed. After validation of invoices and determination of market values by the ARCHITECT, invoices for Specialty WORK based upon the current fair market value thereof may be accepted without complete itemization of labor, material, and equipment rental costs.
 2. When the CONTRACTOR is required to perform WORK necessitating special fabrication or machining process in a fabrication or a machine shop facility away from the job site, the charges for that portion of the WORK performed at the off-site facility may, by agreement, be accepted as Specialty WORK and accordingly, the invoices for the WORK may be accepted without detailed itemization.
 3. All invoices for specialty WORK will be adjusted by deducting all trade discounts offered or available, whether the discounts were taken or not. In lieu of the allowances for overhead and profit specified in Paragraph 11.4, herein, an allowance of 5 percent will be added to invoices for specialty WORK.

SECTION 00700 - GENERAL CONDITIONS

- G. Sureties. All WORK performed hereunder shall be subject to all of the provisions of the Contract Documents and the CONTRACTOR's sureties shall be bound with reference thereto as under the original Agreement. Copies of all amendments to surety Bonds or supplemental surety Bonds shall be submitted to the OWNER for review prior to the performance of any WORK hereunder.

11.4 CONTRACTOR'S FEE

- A. Extra WORK ordered on the basis of time and materials will be paid for at the actual necessary cost as determined by the ARCHITECT, plus allowances for overhead and profit. The allowance for overhead and profit shall include full compensation for superintendence, Bond and insurance premiums, taxes, field office expense, extended overhead, home office overhead, and all other items of expense or cost not included in the cost of labor, materials, or equipment provided for under Paragraph 11.3. The allowance for overhead and profit will be made in accordance with the following schedule:

Actual Overhead and Profit Allowance

Labor	15 percent
Materials	10 percent
Equipment.....	10 percent

To the sum of the costs and mark-ups provided for in this Article, one (1) percent shall be added as compensation for Bonds.

- B. It is understood that labor, materials, and equipment may be furnished by the CONTRACTOR or by the Subcontractor on behalf of the CONTRACTOR. When all or any part of the extra WORK is performed by a Subcontractor, the allowance specified herein shall be applied to the labor, materials, and equipment costs of the Subcontractor, to which the CONTRACTOR may add five (5) percent of the Subcontractor's total cost for the extra WORK. Regardless of the number of hierarchical tiers of Subcontractors, the five (5) percent increase above the Subcontractor's total cost which includes the allowances for overhead and profit specified herein may be applied one time only.

11.5 EXCLUDED COSTS.

- A. The term "Cost of the WORK" shall not include any of the following:
 - 1. Payroll costs and other compensation of CONTRACTOR's officers, executives, principals (of partnership and sole proprietorships), general managers, architects, estimators, attorneys' auditors, accountants, purchasing and contracting agents, expenditures, timekeepers, clerks and other personnel employed by CONTRACTOR whether at the site or in CONTRACTOR's principal or a branch office for general administration of the WORK, or not specifically covered by paragraph 11.3, all of which are to be considered administrative costs covered by the CONTRACTOR's fee.
 - 2. Expenses of CONTRACTOR's principal and branch offices other than CONTRACTOR's office at the site.
 - 3. Any part of CONTRACTOR's capital expenses, including interest on CONTRACTOR's capital employed for the WORK and charges against CONTRACTOR for delinquent payments.

SECTION 00700 - GENERAL CONDITIONS

4. Cost of premiums for all Bonds and for all insurance whether or not CONTRACTOR is required by the Contract Documents to purchase and maintain the same (except for the cost of premiums covered by paragraph 11.4 above).
5. Costs due to the negligence of CONTRACTOR, any Subcontractor, or anyone directly or indirectly employed by any of them or for whose acts any of them may be liable, including but not limited to, the correction of Defective WORK, disposal of materials or equipment wrongly supplied and making good any damage to property.
6. Other overhead or general expense costs of any kind and the cost of any item not specifically and expressly included in paragraph 11.4.

ARTICLE 12 CHANGE OF CONTRACT TIME

12.1 GENERAL

- A. The Contract Time may only be changed by a Change Order. Any claim for an extension of the Contract Time (or Milestones) shall be based on written notice delivered by the CONTRACTOR to the ARCHITECT promptly (but in no event later than 30 days) after the occurrence of the event giving rise to the claim and stating the general nature of the claim. Notice of the extent of the claim with supporting data shall be delivered within 60 days after such occurrence (unless the ARCHITECT allows an additional period of time to ascertain more accurate data in support of the claim) and shall be accompanied by the CONTRACTOR's written statement that the adjustment claimed is the entire adjustment to which the CONTRACTOR has reason to believe it is entitled as a result of the occurrence of said event. All claims for adjustment in the Contract Time shall be determined by the ARCHITECT in accordance with Paragraph 9.8 if the OWNER and the CONTRACTOR cannot otherwise agree. No claim for an adjustment in the Contract Time will be valid if not submitted in accordance with the requirements of this paragraph. An increase in Contract Time does not mean that the CONTRACTOR is due an increase in Contract Price. Only Compensable time extensions will result in an increase in Contract Price.
- B. All time limits stated in the Contract Documents are of the essence of the Agreement.
- C. Where CONTRACTOR is prevented from completing any part of the WORK within the Contract Times (or Milestones) due to delay beyond the control of CONTRACTOR, the Contract Times (or Milestones) will be extended in an amount equal to the time lost on the critical path of the Project due to such delay if a claim is made therefor as provided in paragraph 12.1. Delays beyond the control of CONTRACTOR shall include, but not be limited to, acts or neglect by OWNER, acts or neglect of utility owners or other contractors performing other work as contemplated by Article 7, fires, floods, epidemics, unprecedented weather conditions or acts of God. Delays attributable to and within the control of a Subcontractor or Supplier shall be deemed to be delays within the control of CONTRACTOR.
- D. Where CONTRACTOR is prevented from completing any part of the WORK within the Contract Times (or Milestones) due to delay beyond the control of both OWNER and CONTRACTOR, an extension of the Contract Times (or Milestones) in an amount equal to the time lost on the critical path of the Project due to such delay shall be CONTRACTOR's sole and exclusive remedy for such delay. In no event shall the OWNER be liable to CONTRACTOR, any Subcontractor, any Supplier, or any other person or organization, or to any surety for or employee or agent of any of them, for damages arising out of or resulting from (i) delays caused by or within the control of

SECTION 00700 - GENERAL CONDITIONS

CONTRACTOR, or (ii) delays beyond the control of both parties including but not limited to fires, floods, epidemics abnormal weather conditions, acts of God or acts or neglect by utility owners or other contractors performing other work as contemplated by Article 7.

- 12.2 EXTENSIONS OF TIME FOR DELAY DUE TO WEATHER. Contract time may be extended by the ARCHITECT because of delays in completion of the WORK due to unusually severe weather, provided that the CONTRACTOR shall, within 10 days of the beginning of any such delay, notify the ARCHITECT in writing of the cause of delay and request an extension of contract time. The ARCHITECT will ascertain the facts and the extent of the delay and extend the time for completing the WORK when, in the ARCHITECT's judgment, the findings of fact justify such an extension. Unprecedented, abnormal, or unusually severe weather will be defined as an event, or events, with a greater than 50-year recurrence interval, as determined by the National Weather Service, or equivalent state or federal agency.

ARTICLE 13 WARRANTY AND GUARANTEE; TESTS AND INSPECTIONS; CORRECTION, REMOVAL, OR ACCEPTANCE OF DEFECTIVE WORK

- 13.1 WARRANTY AND GUARANTEE. The CONTRACTOR warrants and guarantees to the OWNER and the ARCHITECT that all WORK will be in accordance with the Contract Documents and will not be defective. Prompt notice of defects known to the OWNER or ARCHITECT shall be given to the CONTRACTOR. All Defective WORK, whether or not in place, may be rejected, corrected, or accepted as provided in this Article 13.
- 13.2 ACCESS TO WORK. The OWNER, ARCHITECT, Architect of Record, their consultants, sub-consultants, other representatives and personnel of OWNER, independent testing laboratories and governmental agencies with jurisdictional interests will have access to the WORK at reasonable times for their observation, inspecting and testing. CONTRACTOR shall provide them proper and safe conditions for such access and advise them of CONTRACTOR's site safety procedures and programs so that they may comply therewith as applicable.
- 13.3 INSPECTIONS AND TESTS
- A. The CONTRACTOR shall give the ARCHITECT timely notice of readiness of the WORK for all required inspections, tests, or approvals, and shall cooperate with inspection and testing personnel to facilitate required inspections or tests.
 - B. If Laws or Regulations of any public body having jurisdiction other than the OWNER require any WORK to specifically be inspected, tested, or approved, the CONTRACTOR shall pay all costs in connection therewith. The CONTRACTOR shall also be responsible for and shall pay all costs in connection with any inspection or testing required in connection with the OWNER's or the ARCHITECT's acceptance of a Supplier of materials or equipment proposed as a substitution or (or-equal) to be incorporated in the WORK, or of materials or equipment submitted for review prior to the CONTRACTOR's purchase thereof for incorporation in the WORK. The cost of all inspections, tests, and approvals in addition to the above which are required by the Contract Documents shall be paid by the OWNER (unless otherwise specified).
 - C. The ARCHITECT will make, or have made, such inspections and tests as the ARCHITECT deems necessary to see that the WORK is being accomplished in accordance with the requirements of the Contract Documents. Unless otherwise specified in the Supplementary General Conditions, the cost

SECTION 00700 - GENERAL CONDITIONS

of such inspection and testing will be borne by the OWNER. In the event such inspections or tests reveal non-compliance with the requirements of the Contract Documents, the CONTRACTOR shall bear the cost of corrective measures deemed necessary by the ARCHITECT, as well as the cost of subsequent re-inspection and retesting. Neither observations by the ARCHITECT nor inspections, tests, or approvals by others shall relieve the CONTRACTOR from the CONTRACTOR's obligation to perform the WORK in accordance with the Contract Documents.

- D. All inspections, tests, or approvals other than those required by Laws or Regulations of any public body having jurisdiction shall be performed by organizations acceptable to the ARCHITECT and the CONTRACTOR.
 - E. If any WORK (including the work of others anticipated under paragraph 7.1) that is to be inspected, tested, or approved is covered without written concurrence of the ARCHITECT, it must, if requested by the ARCHITECT, be uncovered for observation. Such uncovering shall be at the CONTRACTOR's expense unless the CONTRACTOR has given the ARCHITECT timely notice of the CONTRACTOR's intention to perform such test or to cover the same and the ARCHITECT has not acted with reasonable promptness in response to such notice.
 - F. If any WORK is covered contrary to the written request of the ARCHITECT, it must, if requested by the ARCHITECT, be uncovered for the ARCHITECT's observation and recovered at the CONTRACTOR's expense.
 - G. If the ARCHITECT considers it necessary or advisable that covered WORK be observed by the ARCHITECT or inspected or tested by others, the CONTRACTOR, at the ARCHITECT's request, shall uncover, expose, or otherwise make available for observation, inspection, or testing as the ARCHITECT may require, that portion of the WORK in question, furnishing all necessary labor, material, and equipment. If it is found that such WORK is defective, the CONTRACTOR shall bear all direct, indirect, and consequential costs and damages of such uncovering, exposure, observation, inspection, and testing and of satisfactory reconstruction, including but not limited to fees and charges of Architects of Record, attorneys, and other professionals. However, if such WORK is not found to be defective, the CONTRACTOR shall be allowed an increase in the Contract Price or an extension of the Contract Time, or both, directly attributable to such uncovering, exposure, observation, inspection, testing, and reconstruction; and, if the parties are unable to agree as to the amount or extent thereof, the CONTRACTOR may make a claim therefor as provided in Articles 11 and 12.
- 13.4 OWNER MAY STOP THE WORK. If the WORK is defective, or the CONTRACTOR fails to perform WORK in such a way that the completed WORK will conform to the Contract Documents, the OWNER may order the CONTRACTOR to stop the WORK, or any portion thereof, until the cause for such order has been eliminated; however, this right of the OWNER to stop the WORK shall not give rise to any duty on the part of the OWNER to exercise this right for the benefit of the CONTRACTOR or any other party.
- 13.5 CORRECTION OR REMOVAL OF DEFECTIVE WORK. If required by the ARCHITECT, the CONTRACTOR shall promptly, either correct all Defective WORK, whether or not fabricated, installed, or completed, or, if the WORK has been rejected by the ARCHITECT, remove it from the site and replace it with non-defective WORK. The CONTRACTOR shall bear all direct, indirect and consequential costs and damages of such correction or removal, including but not limited to fees and charges of Architects of Record, attorneys, and other professionals made necessary thereby.

SECTION 00700 - GENERAL CONDITIONS

13.6 ONE YEAR CORRECTION PERIOD

- A. If within one year after the date of Substantial Completion or such longer period of time as may be prescribed by Laws or Regulations or by the terms of any applicable special guarantee required by the Contract Documents or by any specific provision of the Contract Documents, any WORK is found to be defective, the CONTRACTOR shall promptly, without cost to the OWNER and in accordance with OWNER's written notification, (i) correct such Defective WORK, or, if it has been rejected by the OWNER, remove it from the site and replace it with non-defective WORK, and (ii) satisfactorily correct or remove and replace any damage to other work of others resulting therefrom. If the CONTRACTOR does not promptly comply with such notification, or in an emergency where delay would cause serious risk of loss or damage, the OWNER may have the Defective WORK corrected or the rejected WORK removed and replaced, and all direct, indirect, and consequential costs and damages of such removal and replacement including but not limited to fees and charges of Architects of Record, attorneys and other professionals will be paid by the CONTRACTOR.
- B. Where Defective WORK (and damage to other WORK resulting therefrom) has been corrected, removed or replaced under this paragraph 13.6, the correction period hereunder with respect to such WORK will be extended for an additional period of one year after such correction or removal and replacement has been satisfactorily completed.

13.7 ACCEPTANCE OF DEFECTIVE WORK. If, instead of requiring correction or removal and replacement of Defective WORK, the OWNER prefers to accept the WORK, the OWNER may do so. The CONTRACTOR shall bear all direct, indirect, and consequential costs attributable to the OWNER's evaluation of and determination to accept such Defective WORK. If any such acceptance occurs prior to final payment, a Change Order will be issued incorporating the necessary revisions in the Contract Documents with respect to the WORK, and the OWNER shall be entitled to an appropriate decrease in the Contract Price.

ARTICLE 14 PAYMENTS TO CONTRACTOR AND COMPLETION

14.1 SCHEDULE OF VALUES (LUMP SUM PRICE BREAKDOWN). The Schedule of Values or lump sum price breakdown established as provided in the General Requirements shall serve as the basis for progress payments and will be incorporated into a form of Application for Payment acceptable to the ARCHITECT.

14.2 UNIT PRICE BID SCHEDULE. Progress payments on account of Unit Price WORK will be based on the number of units completed.

14.3 APPLICATION FOR PROGRESS PAYMENT

- A. Unless otherwise prescribed by law, on the 25th of each month, the CONTRACTOR shall submit to the ARCHITECT for review, an Application for Payment filled out and signed by the CONTRACTOR covering the WORK completed as of the date of the Application and accompanied by such supporting documentation as is required by the Contract Documents.
- B. The Application for Payment shall identify, as a sub-total, the amount of the CONTRACTOR's Total Earnings to Date, plus the Value of Materials Stored at the Site which have not yet been incorporated in the WORK, and less a deductive adjustment for materials installed which were not previously

SECTION 00700 - GENERAL CONDITIONS

incorporated in the WORK, but for which payment was allowed under the provisions for payment for Materials Stored at the Site, but not yet incorporated in the WORK.

- C. The Net Payment Due the CONTRACTOR shall be the above-mentioned subtotal from which shall be deducted the total amount of all previous payments made to the CONTRACTOR. Progress payments will be paid in full in accordance with Article 14 of the General Conditions until 90% of the contract amount has been paid. The remaining 10% of the contract amount shall be retained until:

1. final inspection has been made;
2. completion of the project;
3. acceptance of the project by the OWNER and;
4. the OWNER has received notification from the Alaska Department of Labor that the CONTRACTOR has no outstanding wage/hour violations.

- D. The Value of Materials Stored at the Site shall be an amount equal to the specified percent of the value of such materials as set forth in the Supplementary General Conditions. Said amount shall be based upon the value of all acceptable materials and equipment not incorporated in the WORK but delivered and suitably stored at the Project site or at another location agreed to in writing; provided, each such individual item has a value of more than \$5000 and will become a permanent part of the WORK. The Application for Payment shall also be accompanied by a bill of sale, invoice, or other documentation warranting that the CONTRACTOR has received the materials and equipment free and clear of all liens, charges, security interests, and encumbrances (which are hereinafter in these General Conditions referred to as "Liens") and evidence that the materials and equipment are covered by appropriate property insurance and other arrangements to protect the OWNER's interest therein, all of which will be satisfactory to the OWNER.

14.4 CONTRACTOR'S WARRANTY OF TITLE. The CONTRACTOR warrants and guarantees that title to all WORK, materials, and equipment covered by an Application for Payment, whether incorporated in the WORK or not, will pass to the OWNER no later than the time of payment free and clear of all liens.

14.5 REVIEW OF APPLICATIONS FOR PROGRESS PAYMENT

- A. The ARCHITECT will, within seven (7) days after receipt of each Application for Payment, either indicate in writing a recommendation of payment and present the Application to the OWNER, or return the Application to the CONTRACTOR indicating in writing the ARCHITECT's reasons for refusing to recommend payment. In the later case, the CONTRACTOR may make the necessary corrections and resubmit the Application. If the ARCHITECT still disagrees with a portion of the Application, it will submit the Application recommending the undisputed portion of the Application to the OWNER for review and provide reasons for recommending non-payment of the disputed amount. Thirty days after presentation of the Application for Payment with the ARCHITECT's recommendation, the amount recommended will (subject to the provisions of Paragraph 14.5B) become due and when due will be paid by the OWNER to the CONTRACTOR.
- B. The OWNER may refuse to make payment of the full amount recommended by the ARCHITECT because claims have been made against the OWNER on account of the CONTRACTOR's performance of the WORK or Liens have been filed in connection with the WORK or there are other items entitling the OWNER to a credit against the amount recommended, but the OWNER must give

SECTION 00700 - GENERAL CONDITIONS

the CONTRACTOR written notice within seven (7) days (with a copy to the ARCHITECT) stating the reasons for such action.

SECTION 00700 - GENERAL CONDITIONS

14.6 PARTIAL UTILIZATION

- A. The OWNER shall have the right to utilize or place into service any item of equipment or other usable portion of the WORK prior to completion of the WORK. Whenever the OWNER plans to exercise said right, the CONTRACTOR will be notified in writing by the OWNER, identifying the specific portion or portions of the WORK to be so utilized or otherwise placed into service.
- B. It shall be understood by the CONTRACTOR that until such written notification is issued, all responsibility for care and maintenance of all of the WORK shall be borne by the CONTRACTOR. Upon issuance of said written notice of partial utilization, the OWNER will accept responsibility for the protection and maintenance of all such items or portions of the WORK described in the written notice.
- C. The CONTRACTOR shall retain full responsibility for satisfactory completion of the WORK, regardless of whether a portion thereof has been partially utilized by the OWNER and the CONTRACTOR's one year correction period shall commence only after the date of Substantial Completion for the WORK.

14.7 SUBSTANTIAL COMPLETION. When the CONTRACTOR considers the WORK ready for its intended use the CONTRACTOR shall notify the OWNER and the ARCHITECT in writing that the WORK is substantially complete. The CONTRACTOR will attach to this request a list of all WORK items that remain to be completed and a request that the ARCHITECT prepare a Notice of Completion. Within a reasonable time thereafter, the OWNER, the CONTRACTOR, and the ARCHITECT shall make an inspection of the WORK to determine the status of completion. If the ARCHITECT does not consider the WORK substantially complete, or the list of remaining WORK items to be comprehensive, the ARCHITECT will notify the CONTRACTOR in writing giving the reasons thereof. If the ARCHITECT considers the WORK substantially complete, the ARCHITECT will prepare and deliver to the OWNER, for its execution and recording, the Notice of Completion signed by the ARCHITECT and CONTRACTOR, which shall fix the date of Substantial Completion.

14.8 FINAL APPLICATION FOR PAYMENT. After the CONTRACTOR has completed all of the remaining WORK items referred to in Paragraph 14.7 and delivered all maintenance and operating instructions, schedules, guarantees, Bonds, certificates of inspection, record as-built documents (as provided in the General Requirements) and other documents, all as required by the Contract Documents, and after the ARCHITECT has indicated that the WORK is acceptable, the CONTRACTOR may make application for final payment following the procedure for progress payments. The final Application for Payment shall be accompanied by all documentation called for in the Contract Documents, together with complete and legally effective releases or waivers (satisfactory to the OWNER) of all liens arising out of or filed in connection with the WORK.

14.9 FINAL PAYMENT AND ACCEPTANCE

- A. If, on the basis of the ARCHITECT's observation of the WORK during construction and final inspection, and the ARCHITECT's review of the final Application for Payment and accompanying documentation, all as required by the Contract Documents, the ARCHITECT is satisfied that the WORK has been completed and the CONTRACTOR's other obligations under the Contract Documents have been fulfilled, the ARCHITECT will, within 14 days after receipt of the final Application for Payment, indicate in writing the ARCHITECT's recommendation of payment and present the Application to the OWNER for payment.

SECTION 00700 - GENERAL CONDITIONS

- B. After acceptance of the WORK by the OWNER's governing body, the OWNER will make final payment to the CONTRACTOR of the amount remaining after deducting all prior payments and all amounts to be kept or retained under the provisions of the Contract Documents, including the following items:
1. Liquidated damages, as applicable.
 2. Two times the value of outstanding items of correction WORK or punch list items yet uncompleted or uncorrected, as applicable. All such WORK shall be completed or corrected to the satisfaction of the OWNER within the time stated on the Notice of Completion, otherwise the CONTRACTOR does hereby waive any and all claims to all monies withheld by the OWNER to cover the value of all such uncompleted or uncorrected items.

14.10 RELEASE OF RETAINAGE AND OTHER DEDUCTIONS

- A. After executing the necessary documents to initiate the lien period, and not more than 45 days thereafter (based on a 30-day lien filing period and 15-day processing time), the OWNER will release to the CONTRACTOR the retainage funds withheld pursuant to the Agreement, less any deductions to cover pending claims against the OWNER pursuant to Paragraph 14.5B.
- B. After filing of the necessary documents to initiate the lien period, the CONTRACTOR shall have 30 days to complete any outstanding items of correction WORK remaining to be completed or corrected as listed on a final punch list made a part of the Notice of Completion. Upon expiration of the 45 days, referred to in Paragraph 14.10A, the amounts withheld pursuant to the provisions of Paragraph 14.9B herein, for all remaining WORK items will be returned to the CONTRACTOR; provided, that said WORK has been completed or corrected to the satisfaction of the OWNER within said 30 days. Otherwise, the CONTRACTOR does hereby waive any and all claims for all monies withheld by the OWNER under the contract to cover 2 times the value of such remaining uncompleted or uncorrected items.

14.11 CONTRACTOR'S CONTINUING OBLIGATION. The CONTRACTOR's obligation to perform and complete the WORK in accordance with the Contract Documents shall be absolute. Neither recommendation of any progress or final payment by the ARCHITECT, nor the issuance of a Notice of Completion, nor any payment by the OWNER to the CONTRACTOR under the Contract Documents, nor any use or occupancy of the WORK or any part thereof by the OWNER, nor any act of acceptance by the OWNER nor any failure to do so, nor any review of a Shop Drawing or sample submittal, will constitute an acceptance of WORK not in accordance with the Contract Documents or a release of the CONTRACTOR's obligation to perform the WORK in accordance with the Contract Documents.

14.12 FINAL PAYMENT TERMINATES LIABILITY OF OWNER. Final payment is defined as the last progress payment made to the CONTRACTOR for earned funds, less monies withheld as applicable, pursuant to Paragraph 14.10A. The acceptance by the CONTRACTOR of the final payment referred to in Paragraph 14.9 herein, shall be a release of the OWNER and its agents from all claims of liability to the CONTRACTOR for anything done or furnished for, or relating to, the WORK or for any act of neglect of the OWNER or of any person relating to or affecting the WORK, except demands against the OWNER for the remainder, if any, of the amounts kept or retained under the provisions of Paragraph 14.9 herein; and excepting pending, unresolved claims filed prior to the date of the Notice of Completion.

SECTION 00700 - GENERAL CONDITIONS

ARTICLE 15 SUSPENSION OF WORK AND TERMINATION

- 15.1 SUSPENSION OF WORK BY OWNER. The OWNER, acting through the ARCHITECT, may, at any time and without cause, suspend the WORK or any portion thereof for a period of not more than 90 days by notice in writing to the CONTRACTOR. The CONTRACTOR shall resume the WORK on receipt from the ARCHITECT of a notice of resumption of WORK. The CONTRACTOR shall be allowed an increase in the Contract Price or an extension of the Contract Time, or both, directly attributable to any suspension if the CONTRACTOR makes an approved claim therefor as provided in Articles 11 and 12.
- 15.2 TERMINATION OF AGREEMENT BY OWNER (CONTRACTOR DEFAULT)
- A. In the event of default by the CONTRACTOR, the OWNER may give 10 days written notice to the CONTRACTOR of OWNER's intent to terminate the Agreement and provide the CONTRACTOR an opportunity to remedy the conditions constituting the default. It shall be considered a default by the CONTRACTOR whenever CONTRACTOR shall: (1) declare bankruptcy, become insolvent, or assign its assets for the benefit of its creditors; (2) fail to provide materials or quality of WORK meeting the requirements of the Contract Documents; (3) disregard or violate provisions of the Contract Documents or ARCHITECT's instructions; (4) fail to prosecute the WORK according to the approved progress schedule; or, (5) fail to provide a qualified superintendent, competent workers, or materials or equipment meeting the requirements of the Contract Documents. If the CONTRACTOR fails to remedy the conditions constituting default within the time allowed, the OWNER may then issue the Notice of Termination.
- B. In the event the Agreement is terminated in accordance with Paragraph 15.2A, herein, the OWNER may take possession of the WORK and may complete the WORK by whatever method or means the OWNER may select. The cost of completing the WORK shall be deducted from the balance which would have been due the CONTRACTOR had the Agreement not been terminated and the WORK completed in accordance with the Contract Documents. If such cost exceeds the balance which would have been due, the CONTRACTOR shall pay the excess amount to the OWNER. If such cost is less than the balance which would have been due, the CONTRACTOR shall not have claim to the difference.
- 15.3 TERMINATION OF AGREEMENT BY OWNER (FOR CONVENIENCE). The OWNER may terminate the Agreement at any time if it is found that reasons beyond the control of either the OWNER or CONTRACTOR make it impossible or against the OWNER's interests to complete the WORK. In such a case, the CONTRACTOR shall have no claims against the OWNER except: (1) for the value of WORK performed up to the date the Agreement is terminated; and, (2) for the cost of materials and equipment on hand, in transit, or on definite commitment, as of the date the Agreement is terminated, which would be needed in the WORK and which meet the requirements of the Contract Documents. The value of WORK performed and the cost of materials and equipment delivered to the site, as mentioned above, shall be determined by the ARCHITECT in accordance with the procedure prescribed for the making of the final Application for Payment and payment under Paragraphs 14.8 and 14.9.
- 15.4 TERMINATION OF AGREEMENT BY CONTRACTOR. The CONTRACTOR may terminate the Agreement upon 10 days written notice to the OWNER, whenever: 1) the WORK has been suspended under the provisions of Paragraph 15.1, herein, for more than 90 consecutive days through

SECTION 00700 - GENERAL CONDITIONS

no fault or negligence of the CONTRACTOR, and notice to resume WORK or to terminate the Agreement has not been received from the OWNER within this time period; or, 2) the OWNER should fail to pay the CONTRACTOR any monies due to the CONTRACTOR in accordance with the terms of the Contract Documents and within 60 days after presentation to the OWNER by the CONTRACTOR of a request therefor, unless within said 10-day period the OWNER shall have remedied the condition upon which the payment delay was based. In the event of such termination, the CONTRACTOR shall have no claims against the OWNER except for those claims specifically enumerated in Paragraph 15.3, herein, and as determined in accordance with the requirements of said paragraph.

ARTICLE 16 MISCELLANEOUS

- 16.1 GIVING NOTICE. Whenever any provision of the Contract Documents requires the giving of written notice, it will be deemed to have been validly given if delivered in person to the individual or to a member of the firm or to an officer of the corporation for whom it is intended, or if delivered at or sent by registered or certified mail, postage prepaid, to the last business address known to the giver of the notice.
- 16.2 RIGHTS IN AND USE OF MATERIALS FOUND ON THE WORK
- A. The CONTRACTOR may use on the Project, with ARCHITECT's approval, such stone, gravel, sand, or other material determined suitable by the ARCHITECT, as may be found in the excavation. The CONTRACTOR will be paid for the excavation of such material at the corresponding contract unit price. No additional payment will be made for utilizing the material from excavation as borrow, or select borrow.
 - B. The CONTRACTOR shall replace, at its own expense, with other acceptable material, all of that portion of the excavated material so removed and used which was needed for use on the Project. No charge for the materials so used will be made against the CONTRACTOR except that the CONTRACTOR shall be responsible for payment of any royalties required.
 - C. The CONTRACTOR shall not excavate or remove any material from within the Project location which is not within the grading limits, as indicated by the slope and grade lines, without written authorization from the ARCHITECT.
 - D. In the event the CONTRACTOR has processed materials from OWNER-furnished sources in excess of the quantities required for performance of this contract, including any waste material produced as a by-product, the CBJ may retain possession of such materials without obligation to reimburse the CONTRACTOR for the cost of their production. When such materials are in a stockpile, the ARCHITECT may require: that it remain in stockpile; the CONTRACTOR level such stockpile(s); or that the CONTRACTOR remove such materials and restore the premises to a satisfactory condition at the CONTRACTOR's expense. This provision shall not preclude the CBJ from arranging with the CONTRACTOR to produce material over and above the contract needs, payment for which shall be by written agreement between the CBJ and the CONTRACTOR.
 - E. Unless otherwise provided, the material from any existing old structure may be used temporarily by the CONTRACTOR in the erection of the new structure. Such material shall not be cut or otherwise damaged except with the approval of the ARCHITECT.

SECTION 00700 - GENERAL CONDITIONS

- 16.3 **RIGHT TO AUDIT.** If the CONTRACTOR submits a claim to the OWNER for additional compensation, the OWNER shall have the right, as a condition to considering the claim, and as a basis for evaluation of the claim, and until the claim has been settled, to audit the CONTRACTOR's books to the extent they are relevant. This right shall include the right to examine books, records, documents, and other evidence and accounting procedures and practices, sufficient to discover and verify all direct and indirect costs of whatever nature claimed to have been incurred or anticipated to be incurred and for which the claim has been submitted. The right to audit shall include the right to inspect the CONTRACTOR's plants, or such parts thereof, as may be or have been engaged in the performance of the WORK. The CONTRACTOR further agrees that the right to audit encompasses all subcontracts and is binding upon Subcontractors. The rights to examine and inspect herein provided for shall be exercisable through such representatives as the OWNER deems desirable during the CONTRACTOR's normal business hours at the office of the CONTRACTOR. The CONTRACTOR shall make available to the OWNER for auditing, all relevant accounting records and documents, and other financial data, and upon request, shall submit true copies of requested records to the OWNER.
- 16.4 **ARCHAEOLOGICAL OR HISTORICAL DISCOVERIES.** When the CONTRACTOR's operation encounters prehistoric artifacts, burials, remains of dwelling sites, paleontological remains, such as shell heaps, land or sea mammal bones or tusks, or other items of historical significance, the CONTRACTOR shall cease operations immediately and notify the ARCHITECT. No artifacts or specimens shall be further disturbed or removed from the ground and no further operations shall be performed at the site until so directed. Should the ARCHITECT order suspension of the CONTRACTOR's operations in order to protect an archaeological or historical finding, or order the CONTRACTOR to perform extra WORK, such order(s) shall be covered by an appropriate contract change document.
- 16.5 **CONSTRUCTION OVER OR ADJACENT TO NAVIGABLE WATERS.** All WORK over, on, or adjacent to navigable waters shall be so conducted that free navigation of the waterways will not be interfered with and the existing navigable depths will not be impaired, except as allowed by permit issued by the U.S. Coast Guard and/or the U.S. Army Corps of Engineers, as applicable.
- 16.6 **GRATUITY AND CONFLICT OF INTEREST.** The CONTRACTOR agrees to not extend any loan, gratuity or gift of money of any form whatsoever to any employee or elected official of the OWNER, nor will the CONTRACTOR rent or purchase any equipment or materials from any employee or elected official of the OWNER, or to the best of the CONTRACTOR's knowledge, from any agent of any employee or elected official of the OWNER. Before final payment, the CONTRACTOR shall execute and furnish the OWNER an affidavit certifying that the CONTRACTOR has complied with the above provisions of the contract.
- 16.7 **SUITS OF LAW CONCERNING THE WORK**
- A. Should a suit of law be entered into, either by the CONTRACTOR (or the CONTRACTOR's surety) against the OWNER, or by the OWNER against the CONTRACTOR (or the CONTRACTOR's surety), the suit of law shall be tried in the First Judicial District of Alaska.
 - B. If one of the questions at issue is the satisfactory performance of the WORK by the CONTRACTOR and should the appropriate court of law judge the WORK of the CONTRACTOR to be unsatisfactory, then the CONTRACTOR (or the CONTRACTOR's surety) shall reimburse the

SECTION 00700 - GENERAL CONDITIONS

OWNER for all legal and all other expenses (as may be allowed and set by the court) incurred by the OWNER because of the suit of the law and, further, it is agreed that the OWNER may deduct such expense from any sum or sums then, or any that become due the CONTRACTOR under the contract.

16.8 CERTIFIED PAYROLLS

- A. All CONTRACTORS or Subcontractor who perform work on a public construction contract for the OWNER shall file a Certified Payroll with the Alaska Department of Labor every two weeks. Before the second Friday, each CONTRACTOR and Subcontractor must file Certified Payrolls with Statements of Compliance for the previous two weeks. (Section 14-2-4 ACLA 1949; am Section 4 ch 142 SLA 1972).
- B. In lieu of submitting the State payroll form, the CONTRACTOR's standard payroll form may be submitted, provided it contains the information required by AS 36.05.040 and a statement that the CONTRACTOR is complying with AS 36.10.010.
- C. Any CONTRACTOR or Subcontractor, who performs work on public construction in the State, as defined by AS 36.95.010(3), shall pay not less than the current prevailing rate of wages as issued by the Alaska Department of Labor before the end of the pay period. (AS 36.05.010).

16.9 PREVAILING WAGE RATES

- A. Wage rates for Laborers and Mechanics on Public Contracts, AS 36.05.070. The CONTRACTOR, or Subcontractors, shall pay all employees unconditionally and not less than once a week. Wages may not be less than those stated in Paragraph 16.8C, regardless of the contractual relationship between the CONTRACTOR or Subcontractors and laborers, mechanics, or field surveyors. The scale of wages to be paid shall be posted by the CONTRACTOR in a prominent, easily accessible place at the site of the WORK.
- B. Failure to Pay Agreed Wages, AS 36.05.080. If it is found that a laborer, mechanic, or field surveyor employed by the CONTRACTOR or Subcontractor has been, or is being, paid a rate or wages less than the established rate, the OWNER may, by written notice, terminate the CONTRACTOR or Subcontractors right to proceed with the WORK. The OWNER may prosecute the WORK to completion by contract or otherwise, and the CONTRACTOR and sureties will be held liable to the OWNER for excess costs for completing the WORK. (Section 2 ch 52 SLA 1959).
- C. Listing CONTRACTORS Who Violate contracts, AS 36.05.090. In addition, a list giving the names of persons who have disregarded the rights of their employees shall be distributed to all departments of State government and all political subdivisions. No person appearing on this list, and no firm, corporation, partnership or association in which the person has an interest, may WORK as a CONTRACTOR or Subcontractor on a public construction contract for the State, or a political subdivision of the state, until three years after the date of publication of the list. (Section 3 ch 52 SLA 1959; am Section 9 ch 142 SLA).

16.10 EMPLOYMENT REFERENCE. Workers employed in the execution of the contract by the CONTRACTOR or by any Subcontractor under this contract shall not be required or permitted to labor more than 8 hours a day or 40 hours per week in violation of the provisions of the Alaska Wage and Hour Act, Section 23.10.060.

SECTION 00700 - GENERAL CONDITIONS

16.11 COST REDUCTION INCENTIVE

- A. At any time within 45 days after the date of the Notice of Award, the CONTRACTOR may submit to the ARCHITECT in writing, proposals for modifying the plans, specifications, or other requirements of this contract for the sole purpose of reducing the total cost of construction. The cost reduction proposal shall not impair in any manner the essential functions or characteristics of the project, including but not limited to, service life, economy of operation, ease of maintenance, desired appearance or design and safety standards.
- B. The cost reduction proposal shall contain the following information:
 - 1. Description of both the existing contract requirements for performing the WORK and the proposed changes.
 - 2. An itemization of the contract requirements that must be changed if the proposal is adopted.
 - 3. A detailed estimate of the time required and the cost of performing the WORK under both the existing contract and the proposed change.
 - 4. A statement of the date by which the CONTRACTOR must receive the decision from the OWNER on the cost reduction proposal.
 - 5. The contract items of WORK effected by the proposed changes including any quantity variations.
 - 6. A description and estimate of costs the OWNER may incur in implementing the proposed changes, such as test and evaluation and operating and support costs.
 - 7. A prediction of any effects the proposed change would have on future operations and maintenance costs to the OWNER.
- C. The provisions of this section shall not be construed to require the OWNER to consider any cost reduction proposal which may be submitted; nor will the OWNER be liable to the CONTRACTOR for failure to accept or act upon any cost reduction proposal submitted, or for delays to the WORK attributable to the consideration or implementation of any such proposal.
- D. If a cost reduction proposal is similar to a change in the plans or Specifications for the Project under consideration by the OWNER at the time the proposal is submitted, the OWNER will not accept such proposal and reserves the right to make such changes without compensation to the CONTRACTOR under the provisions of this section.
- E. The CONTRACTOR shall continue to perform the WORK in accordance with the requirements of the contract until an executed Change Order incorporating the cost reduction proposal has been issued. If any executed Change Order has not been issued by the date upon which the CONTRACTOR's cost reduction proposal specifies that a decision should be made by the OWNER, in writing, the cost reduction proposal shall be considered rejected.
- F. The OWNER, shall be the sole judge of the acceptability of a cost reduction proposal and of the estimated net savings in Contract Time and construction costs resulting from the adoption of all or any part of such proposal. Should the CONTRACTOR disagree with OWNER's decision on the cost reduction proposal, there is no further consideration. The OWNER reserves the right to make final determination.
- G. If the CONTRACTOR's cost reduction proposal is accepted in whole or in part, such acceptance will be made by a Contract Change Order, which specifically states that the change is executed pursuant

SECTION 00700 - GENERAL CONDITIONS

to this cost reduction proposal section. Such Change Order shall incorporate the changes in the plans and Specifications which are necessary to permit the cost reduction proposal or such part of it as has been accepted to be put into effect and shall include any conditions upon which the OWNER's approval is based, if such approval is conditional. The Change Order shall also describe the estimated net savings in the cost of performing the WORK attributable to the cost reduction proposal, and shall further provide that the contract cost be adjusted by crediting the OWNER with the estimated net savings amount.

- H. Acceptance of the cost reduction proposal and performance of the WORK does not extend the time of completion of the contract, unless specifically provided in the Change Order authorizing the use of the submitted proposal. Should the adoption of the cost reduction proposal result in a Contract Time savings, the total Contract Time shall be reduced by an amount equal to the time savings realized.
- I. The amount specified to the CONTRACTOR in the Change Order accepted in the cost reduction proposal shall constitute full compensation for the performance of WORK. No claims for additional costs as a result of the changes specified in the cost reduction proposal shall be allowed.
- J. The OWNER reserves the right to adopt and utilize any approved cost reduction proposal for general use on any contract administered when it is determined suitable for such application. Cost reduction proposals identical, similar, or previously submitted will not be accepted for consideration if acceptance and compensation has previously been approved. The OWNER reserves the right to use all or part of any cost reduction proposal without obligation or compensation of any kind to the CONTRACTOR.
- K. The CONTRACTOR shall bear the costs, if any, to revise all Bonds and insurance requirements for the Project, to include the cost reduction WORK.

END OF SECTION

SECTION 00800 - SUPPLEMENTARY GENERAL CONDITIONS

GENERAL. These Supplementary General Conditions make additions, deletions, or revisions to the General Conditions as indicated herein. All provisions which are not so added, deleted, or revised remain in full force and effect. Terms used in these Supplementary General Conditions which are defined in the General Conditions have the meanings assigned to them in the General Conditions.

SGC 1 DEFINITIONS. *Remove* the definition for Contract Documents and *replace* with the following:

Contract Documents – The Table of Contents, Notice Inviting Bids, Instructions to Bidders, Bid Forms (including the Bid, Bid Schedule(s), Subcontractor Report, Bid Bond, and all required certificates and affidavits), Agreement, Performance Bond, Payment Bond, General Conditions, Supplementary General Conditions, Alaska Labor Standards, Reporting, and Prevailing Wage Rate Determination, Special Provisions, Standard Specifications, Technical Specifications, Drawings, Permits, and all Addenda, and Change Orders executed pursuant to the provisions of the Contract Documents.

SGC 2.2 COPIES OF DOCUMENTS. *Add* the following:

The OWNER shall furnish to the CONTRACTOR two (2) hard copies of the Contract Documents which will include bound reduced Drawings and one (1) electronic copy (pdf format) on CD-ROM. Additional copies of contract documents are the responsibility of the contractor.

SGC 3.2 ORDER OF PRECEDENCE OF CONTRACT DOCUMENTS. *Remove* No. 12. Technical Specifications and No. 13. Drawings, and *add* the following:

12. Special Provisions Section
13. Standard Specifications for Civil Engineering Projects and Subdivision Improvements
December 2003 Edition with current Errata Sheets.
14. Drawings.

SGC 4.2 PHYSICAL CONDITIONS - SUBSURFACE AND EXISTING STRUCTURES. *Add* the following:

- C. In the preparation of the Contract Documents, the Engineer of Record has relied upon field measurements and visual inspection of the existing structures and surface conditions.

SGC - 4.6 USE OF THE CBJ/STATE LEMON CREEK GRAVEL PIT. *Add* the following.

The CBJ/State Lemon Creek Gravel Pit is not available for this Project.

SGC 5.1 PERFORMANCE, PAYMENT, AND OTHER BONDS. The Contractor shall furnish Performance and Payment Bonds in the amount of 100% of the Bid.

SGC 5.2 INSURANCE AMOUNTS. The limits of liability for the insurance required by Paragraph 5.2 of the General Conditions shall provide coverage for not less than the following amounts or greater where required by Laws and Regulations. The CONTRACTOR must provide certification of proper insurance coverage and amendatory endorsements or copies of the applicable policy language affecting coverage required in this agreement to the City and Borough of Juneau. All certificates of insurance supplied to the OWNER shall state that the OWNER is named as **“Additional Insured for any and all work performed for the City & Borough of Juneau” for the Commercial General Liability policy and any other policies, if required in this Section.** NOTE: This requirement has changed. The OWNER no longer requires certificates of insurance referencing project names and contract numbers.

SECTION 00800 - SUPPLEMENTARY GENERAL CONDITIONS

Delete paragraph C and *Replace* with the following paragraph C:

- C. The CONTRACTOR shall furnish the OWNER with certificates showing the type, amount, class of operations covered, effective dates and dates of expiration of policies. Failure of CBJ to demand such certificate or other evidence of full compliance with these insurance requirements or failure of CBJ to identify a deficiency from evidence that is provided shall not be construed as a waiver of the obligation of the Contractor to maintain the insurance required by this contract. The coverage afforded will not be cancelled, reduced in coverage, or renewal refused until at least 30 days' prior written notice has been given to the OWNER by the CONTRACTOR. **All such insurance required herein (except for Workers' Compensation and Employer's Liability) shall name the OWNER, its Consultants and subconsultants and their officers, directors, agents, and employees as "additional insureds" under the policies.**

The CONTRACTOR shall purchase and maintain the following insurance:

1. Workers' Compensation and Employer's Liability. This insurance shall protect the CONTRACTOR against all claims under applicable state workers' compensation laws. The CONTRACTOR shall also be protected against claims for injury, disease, or death of employees which, for any reason, may not fall within the provisions of a Workers' Compensation law. The CONTRACTOR shall require each Subcontractor similarly to provide Workers' Compensation Insurance for all of the latter's employees to be engaged in such work unless such employees are covered by the protection afforded by the CONTRACTOR's Workers' Compensation Insurance. In case any class of employees is not protected, under the Workers' Compensation Statute, the CONTRACTOR shall provide and shall cause each subcontractor to provide adequate employer's liability insurance for the protection of such of its employees as are not otherwise protected. **The CONTRACTOR grants a waiver of any right to subrogation against the OWNER by virtue of the payment of any loss under such insurance.** This provision applies regardless of whether or not the OWNER has received a waiver of subrogation endorsement from the insurer.

Workers' Compensation: (under Paragraph 5.2C.1 of the General Conditions) as in accordance with AS 23.30.045:

- a. State: Statutory
- b. Applicable Federal (e.g., Longshore): Statutory

Note: If the WORK called for in the Contract Documents involves work in or on any navigable waters, the CONTRACTOR shall provide Workers' Compensation coverage which shall include coverage under the Longshore and Harbor Workers' Compensation Act, the Jones Act, and any other coverage required under Federal or State laws pertaining to workers in or on navigable waters.

- a. Employers Liability

Bodily Injury by Accident:	\$100,000.00	Each Accident
Bodily Injury by Disease:	\$100,000.00	Each Employee
Bodily Injury by Disease:	\$500,000.00	Policy Limit

1. CONTRACTOR agrees to waive all rights of subrogation against the OWNER for WORK performed under contract.
2. If CONTRACTOR directly utilizes labor outside of the State of Alaska in the

SECTION 00800 - SUPPLEMENTARY GENERAL CONDITIONS

prosecution of the WORK, "Other States" endorsement shall be required as a condition of the contract.

- 2. Commercial General Liability (CGL), including products and completed operations, property damage, bodily injury and personal and advertising injury, with limits no less than \$1,000,000 each occurrence and \$2,000,000 aggregate. (under Paragraph 5.2C.2 of the General Conditions) **This insurance policy is to contain, or be endorsed to contain, additional insured status for the CBJ, its officers, officials, employees, and volunteers.** If Additional insured status is provided in the form of an endorsement to the Contractor's insurance, the endorsement shall be at least as broad as ISO Form CG 20 10 11 85 or **both** CG 20 10, CG 20 26, CG 20 33, or CG 20 38; **and** CG 20 37 forms if later revisions used).
- 3. Commercial Automobile Liability: (under Paragraph 5.2C.3 of the General Conditions) including Owned, Hired, and Non-Owned Vehicles:

Combined Single Limit, Bodily Injury and Property Damage	\$1,000,000.00
--	----------------

This insurance policy is to contain, or be endorsed to contain, additional insured status for the CBJ, its officers, officials, employees, and volunteers The CONTRACTOR shall require each Subcontractor similarly to provide Commercial Automobile Liability Insurance for all of the latter's employees to be engaged in such WORK unless such employees are covered by the protection afforded by the CONTRACTOR's Commercial Automobile Liability Insurance.

Add the following paragraphs:

- C. Builder's Risk: CONTRACTOR is not required to obtain a Builder's Risk insurance policy for this project. The OWNER carries Builder's Risk insurance. If a Builder's Risk claim is filed for this project, the CONTRACTOR will be responsible for the first \$10,000 of the policy's deductible, and the OWNER will be responsible for the remaining deductible.
- D. All Subcontractors are required to secure and maintain the insurance coverages listed above, unless otherwise noted.
- E. If the CONTRACTOR maintains higher limits than the minimums shown above, the OWNER requires and shall be entitled to coverage for the higher limits maintained by the CONTRACTOR. Any available insurance proceeds in excess of the specified minimum limits of insurance and coverage shall be available to the OWNER.
- F. Policies shall also specify insurance provided by CONTRACTOR will be considered primary and not contributory to any other insurance available to the OWNER.
- G. Should any of the policies described above be cancelled before the expiration date thereof, notice will be delivered in accordance with the policy provisions.

SECTION 00800 - SUPPLEMENTARY GENERAL CONDITIONS

SGC 6.5 CONCERNING SUBCONTRACTORS, SUPPLIERS, AND OTHERS. *Add* the following:

B. The CONTRACTOR shall perform not less than 40% of the WORK with its own forces (i.e., without subcontracting). The 40% requirement shall be understood to mean that the CONTRACTOR shall perform, with its own organization, WORK amounting to at least 40% of the original contract amount. The 40% requirement will be calculated based upon the total of the subcontract amounts submitted for Contract Award, and any other information requested by the OWNER from the apparent low Bidder.

SGC 6.5 CONCERNING SUBCONTRACTORS, SUPPLIERS, AND OTHERS, *Add* the following paragraph:

C. CONTRACTOR must pay Subcontractors and/or Suppliers within 30 days of receiving payment from the OWNER, if that payment was made for Work performed by the Subcontractor and/or materials received. Failure to pay Subcontractors within 30 days of receiving payment from which Subcontractor and/or Supplier is to be paid may result in the OWNER initiating debarment proceedings as prescribed in the City and Borough of Juneau Purchasing Code. *The 30 day City and Borough of Juneau requirement does not supersede AS 36.90.210.*

SGC 6.6 PERMITS, *Add* the following paragraph:

D. Contractor is responsible for obtaining a Hot Works permit from the CBJ Permit Center, if performing work which requires such a permit. Work requiring a Hot Works Permit includes but is not limited to the following: cutting, welding, Thermit welding, brazing, soldering, grinding, thermal spraying, thawing pipe, installation of torch-applied roof systems or any other similar activity.

SGC 11.1 CHANGE OF CONTRACT PRICE. *Change* paragraph C., subparagraph 2, to read:

2. By mutual acceptance of a lump sum, which includes a maximum allowance For overhead and profit in accordance with Paragraph 11.4.

SGC 14.3 APPLICATION FOR PROGRESS PAYMENT. Paragraph D.

D. The Value of Materials Stored at the site shall be an amount equal to 85%.

SGC 14.9 FINAL PAYMENT AND ACCEPTANCE. *Add* the following paragraph:

C. Prior to the final payment the CONTRACTOR shall contact the Alaska Department of Labor and Workforce Development (ADOL) and provide the OWNER with clearance from the ADOL for the CONTRACTOR and all Subcontractors that have worked on the Project. This clearance shall indicate that all Employment Security Taxes have been paid. A sample form for this purpose is at the end of this section. The CONTRACTOR shall also submit a "NOTICE OF COMPLETION OF PUBLIC WORKS" signed by ADOL.

SGC 16.8 CERTIFIED PAYROLLS. *Change* paragraph A. to read:

A. All CONTRACTORS or Subcontractors who perform work on a public construction contract for the OWNER shall file a certified payroll with Alaska Department of Labor. See Section 00830 - Alaska Labor Standards, Reporting, and Prevailing Wage Rate Determination.



Tax Clearance Request Form for Contractors

Date of request: _____

Business name of the contractor a Tax Clearance is being requested for: _____

Business address: _____

Business contact phone number: _____

Federal Identification Number: _____

Alaska Employer Account Number: _____

Specific time period a tax clearance is being requested for (*i.e. beginning and ending date of a subcontract agreement*):

Subcontract project name: _____

Name and address of the person this Tax Clearance is to be returned to: _____

Comments or additional information: _____

For agency use only:

- Tax Clearance is granted
- Tax Clearance is not granted (*please have employer contact the department*)
- No account on file, liability unknown (*please have employer contact the department*)
- Employer has stated no employees, Tax Clearance not required.

Agency representative signature: _____ Date: _____

Agency representative title: _____

We are an equal opportunity employer/program. Auxiliary aids and services are available upon request to individuals with disabilities. labor.alaska.gov/estax

**SECTION 00830 - ALASKA LABOR STANDARDS, REPORTING, AND
PREVAILING WAGE RATE DETERMINATION**

State of Alaska, Department of Labor, Laborers' and Mechanics' Minimum Rates of Pay, AS 36.05.010 and AS 36.05.050, Wage and Hour Administration Pamphlet No. 600, the latest edition published by the State of Alaska, Department of Labor inclusive, is provided in its entirety in SECTION 00830 – APPENDIX A.

The CONTRACTOR is responsible for contacting the Alaska Department of Labor to determine compliance with current regulations.

Correspondence regarding Title 36 requirements may be submitted electronically or paper copies can be submitted by mail. To submit Title 36 documents electronically, go to <https://myalaska.state.ak.us/home/app>. If filing electronically, submit certified payrolls to ADOL at the website above and email a copy of all certified payrolls to Greg Smith at the email address below. If Contractor elects to submit paper copies, they should be submitted to the physical addresses below.

Within 10 Days of "Notice of Award/Notice to Proceed" make a list of **all** Subcontractors. Include their name, address, phone, estimated subcontract amount, and estimated start and finish dates. Send this list to the Wage and Hour Section (contact information below).

Certified Payrolls must be submitted every two weeks. Before the second Friday, each CONTRACTOR and Subcontractor must file Certified Payrolls with Statements of Compliance for the previous two weeks. Indicate "**Start**" on your first payroll, and "**Final**" on your last payroll for this Project.

As part of the **final payment request package**, CONTRACTOR must submit a "NOTICE OF COMPLETION OF PUBLIC WORKS" form signed by ADOL personnel.

Contact Information:

Wage and Hour Section
State of Alaska
Department of Labor and Workforce Development
Labor Standards and Safety Division and
Wage and Hour Administration
P.O. Box 11149
Juneau, AK 99811-1149
907-465-4842
<http://labor.state.ak.us/lss/home.htm>

Greg Smith, Contract Administrator
City and Borough of Juneau
155 S. Seward Street
Juneau, AK 99801
(907) 586-0873
Greg.Smith@juneau.org

END OF SECTION

SECTION 00830

APPENDIX A

Laborers' & Mechanics'
Minimum Rates of Pay

Pamphlet 600

Effective April 3, 2020

A photograph of a worker in a hard hat and respirator operating a crane hook in an industrial setting. The worker is wearing a grey long-sleeved shirt and is holding a red crane hook. The background shows a large industrial structure with a curved metal surface.

Laborers' and Mechanics' MINIMUM RATES OF PAY

Effective April 3, 2020
Issue 40

PAMPHLET No. 600

Title 36. Public Contracts
AS 36.05

**DEPARTMENT OF LABOR
AND WORKFORCE DEVELOPMENT**

Wage and Hour Administration

- This page intentionally left blank -



April 3, 2020

TO ALL CONTRACTING AGENCIES:

At the Alaska Department of Labor and Workforce Development, our goal is putting Alaskans to work. This pamphlet is designed to help contractors awarded public construction contracts understand the most significant laws of the State of Alaska pertaining to prevailing wage.

This pamphlet identifies current prevailing wage rates for public construction contracts (any construction projects awarded for the State of Alaska or its political subdivisions, such as local governments and certain non-profit organizations). Because these rates may change in a subsequent determination, please be sure you are using the appropriate rates. The rates published in this edition become effective April 3, 2020.

The prevailing wage rates contained in this pamphlet are applicable to public construction projects with a final bid date of April 13, 2020, or later. As the law now provides, these rates will remain stable during the life of a contract or for 24 calendar months, whichever is shorter. **The 24-month period begins on the date the prime contract is awarded.** Upon expiration of the initial 24-month period, the latest wage rates issued by the department shall become effective for a subsequent 24-month period or until the original contract is completed, whichever occurs first. This process shall be repeated until the original contract is completed.

The term "original contract" means the signed contract that resulted from the original bid and any amendments, including changes of work scope, additions, extensions, change orders, and other instruments agreed to by the parties that have not been subject to subsequent open bid procedures.

If a higher federal rate is required due to partial federal funding or other federal participation, the higher rate must be paid.

For additional copies of this pamphlet go to: <http://labor.state.ak.us/lss/pamp600.htm>

For questions regarding prevailing wage or employment preference requirements, please contact the nearest Wage and Hour office. These offices are listed on Page x.

Sincerely,

A handwritten signature in black ink that reads "Tamika L. Ledbetter".

Dr. Tamika L. Ledbetter
Commissioner

- This page intentionally left blank -

Table of Contents

Excerpts from Alaska Law

Sec. 36.05.005. Applicability.....	iv
Sec. 36.05.010. Wage rates on public construction.	iv
Sec. 36.05.040. Filing schedule of employees, wages paid and other information	iv
Sec. 36.05.045. Notice of work and completion; withholding of payment	iv
Sec. 36.05.060. Penalty for violation of this chapter	v
Sec. 36.05.070. Wage rates in specifications and contracts for public works	v
Sec. 36.05.080. Failure to pay agreed wages.....	v
Sec. 36.05.090. Payment of wages from withheld payments and listing contractors who violate contracts	v
Sec. 36.05.900. Definition.. ..	vi

Excerpts from Alaska Administrative Code

8 AAC 30.051. Purpose	vi
8 AAC 30.052. Board and lodging; remote sites	vi
8 AAC 30.054. Per diem instead of board and lodging	vi
8 AAC 30.056. Alternative arrangement	vii
8 AAC 30.900. General definitions (selected excerpts).....	vii

Additional Information

Per Diem	vii
Laborer Classification Clarification.....	viii
Apprentice Rates.....	viii
Fringe Benefit Plans.....	viii
Special Prevailing Wage Rate Determination.....	ix
Alaska Employment Preference Information.....	ix
Labor Standards and Safety Notice Requests	x
Debarment List	x

Wage Rates Pages 1-26

Note to Readers: The statutes and administrative regulations listed in this publication were taken from the official codes, as of the effective date of the publication. However, there may be errors or omissions that have not been identified and changes that occurred after the publication was printed. This publication is intended as an informational guide only and is not intended to serve as a precise statement of the statutes and regulations of the State of Alaska. To be certain of current laws and regulations, please refer to the official codes.

EXCERPTS FROM ALASKA LAW

Sec. 36.05.005. Applicability.

This chapter applies only to a public construction contract that exceeds \$25,000.

Sec. 36.05.010. Wage rates on public construction.

A contractor or subcontractor who performs work on a public construction contract in the state shall pay not less than the current prevailing rate of wages for work of a similar nature in the region in which the work is done. The current prevailing rate of wages is that contained in the latest determination of prevailing rate of wages issued by the Department of Labor and Workforce Development at least 10 days before the final date for submission of bids for the contract. The rate shall remain in effect for the life of the contract or for 24 calendar months, whichever is shorter. At the end of the initial 24-month period, if new wage determinations have been issued by the department, the latest wage determination shall become effective for the next 24-month period or until the contract is completed, whichever occurs first. This process shall be repeated until the contract is completed.

Sec. 36.05.040. Filing schedule of employees, wages paid, and other information.

All contractors or subcontractors who perform work on a public construction contract for the state or for a political subdivision of the state shall, before the Friday of every second week, file with the Department of Labor and Workforce Development a sworn affidavit for the previous reporting period, setting out in detail the number of persons employed, wages paid, job classification of each employee, hours worked each day and week, and other information on a form provided by the Department of Labor and Workforce Development.

Sec. 36.05.045. Notice of work and completion; withholding of payment.

- (a) Before commencing work on a public construction contract, the person entering into the contract with a contracting agency shall designate a primary contractor for purposes of this section. Before work commences, the primary contractor shall file a notice of work with the Department of Labor and Workforce Development. The notice of work must list work to be performed under the public construction contract by each contractor who will perform any portion of work on the contract and the contract price being paid to each contractor. The primary contractor shall pay all filing fees for each contractor performing work on the contract, including a filing fee based on the contract price being paid for work performed by the primary contractor's employees. The filing fee payable shall be the sum of all fees calculated for each contractor. The filing fee shall be one percent of each contractor's contract price. The total filing fee payable by the primary contractor under this subsection may not exceed \$5,000. In this subsection, "contractor" means an employer who is using employees to perform work on the public construction contract under the contract or a subcontract.
- (b) Upon completion of all work on the public construction contract, the primary contractor shall file with the Department of Labor and Workforce Development a notice of completion together with payment of any additional filing fees owed due to increased contract amounts. Within 30 days after the department's receipt of the primary contractor's notice of completion, the department shall inform the contracting agency of the amount, if any, to be withheld from the final payment.
- (c) A contracting agency
 - (1) may release final payment of a public construction contract to the extent that the agency has received verification from the Department of Labor and Workforce Development that
 - (A) the primary contractor has complied with (a) and (b) of this section;
 - (B) the Department of Labor and Workforce Development is not conducting an investigation under this title; and
 - (C) the Department of Labor and Workforce Development has not issued a notice of a violation of this chapter to the primary contractor or any other contractors working on the public construction contract; and

- (2) shall withhold from the final payment an amount sufficient to pay the department's estimate of what may be needed to compensate the employees of any contractors under investigation on this construction contract, and any unpaid filing fees.
- (d) The notice and filing fee required under (a) of this section may be filed after work has begun if
 - (1) The public construction contract is for work undertaken in immediate response to an emergency; and
 - (2) The notice and fees are filed not later than 14 days after the work has begun.
- (e) A false statement made on a notice required by this section is punishable under AS 11.56.210.

Sec. 36.05.060. Penalty for violation of this chapter.

A contractor who violates this chapter is guilty of a misdemeanor and upon conviction is punishable by a fine of not less than \$100 nor more than \$1,000, or by imprisonment for not less than 10 days nor more than 90 days, or by both. Each day a violation exists constitutes a separate offense.

Sec. 36.05.070. Wage rates in specifications and contracts for public works.

- (a) The advertised specifications for a public construction contract that requires or involves the employment of mechanics, laborers, or field surveyors must contain a provision stating the minimum wages to be paid various classes of laborers, mechanics, or field surveyors and that the rate of wages shall be adjusted to the wage rate under AS 36.05.010.
- (b) Repealed by §17 ch 142 SLA 1972.
- (c) A public construction contract under (a) of this section must contain provisions that
 - (1) the contractor or subcontractors of the contractor shall pay all employees unconditionally and not less than once a week;
 - (2) wages may not be less than those stated in the advertised specifications, regardless of the contractual relationship between the contractor or subcontractors and laborers, mechanics, or field surveyors;
 - (3) the scale of wages to be paid shall be posted by the contractor in a prominent and easily accessible place at the site of the work;
 - (4) the state or a political subdivision shall withhold so much of the accrued payments as is necessary to pay to laborers, mechanics, or field surveyors employed by the contractor or subcontractors the difference between
 - (A) the rates of wages required by the contract to be paid laborers, mechanics, or field surveyors on the work; and
 - (B) the rates of wages in fact received by laborers, mechanics, or field surveyors.

Sec. 36.05.080. Failure to pay agreed wages.

Every contract within the scope of AS 36.05.070 shall contain a provision that if it is found that a laborer, mechanic, or field surveyor employed by the contractor or subcontractor has been or is being paid a rate of wages less than the rate of wages required by the contract to be paid, the state or its political subdivision may, by written notice to the contractor, terminate the contractor's right to proceed with the work or the part of the work for which there is a failure to pay the required wages and to prosecute the work to completion by contract or otherwise, and the contractor and the contractor's sureties are liable to the state or its political subdivision for excess costs for completing the work.

Sec. 36.05.090. Payment of wages from withheld payments and listing contractors who violate contracts.

- (a) The state disbursing officer in the case of a state public construction contract and the local fiscal officer in the case of a political subdivision public construction contract shall pay directly to laborers, mechanics, or field surveyors from accrued payments withheld under the terms of the contract the wages due laborers, mechanics, or field surveyors under AS 36.05.070.
- (b) The state disbursing officer or the local fiscal officer shall distribute to all departments of the state government and to all political subdivisions of the state a list giving the names of persons who have disregarded their obligations to employees. A person appearing on this list and a firm, corporation, partnership, or association in which the person has an interest may not work as a contractor or

subcontractor on a public construction contract for the state or a political subdivision of the state until three years after the date of publication of the list. If the accrued payments withheld under the contract are insufficient to reimburse all the laborers, mechanics, or field surveyors with respect to whom there has been a failure to pay the wages required under AS 36.05.070, the laborers, mechanics, or field surveyors have the right of action or intervention or both against the contractor and the contractor's sureties conferred by law upon persons furnishing labor or materials, and in the proceedings it is not a defense that the laborers, mechanics, or field surveyors accepted or agreed to accept less than the required rate of wages or voluntarily made refunds.

Sec. 36.05.900. Definition.

In this chapter, "contracting agency" means the state or a political subdivision of the state that has entered into a public construction contract with a contractor.

EXCERPTS FROM ALASKA ADMINISTRATIVE CODE

*****Notice:** Regulations relating to board and lodging and per diem went into effect on November 25, 2018. The new regulations are excerpted here***

8 AAC 30.051. Purpose. The purpose of 8 AAC 30.052 – 8 AAC 30.056 is to ensure that wages paid to laborers, mechanics, and field surveyors do not fall below the prevailing rate of pay.

8 AAC 30.052. Board and lodging; remote sites. (a) A contractor on a public construction project located 65 or more road miles from the international airport closest to the project area in either Fairbanks, Juneau, or Anchorage, or that is inaccessible by road in a two-wheel drive vehicle, shall provide adequate board and lodging to each laborer, mechanic, or field surveyor while the person is employed on the project. If commercial lodging facilities are not available, the contractor shall provide temporary lodging facilities. Lodging facilities must comply with all applicable state and federal laws. For a highway project, the location of the project is measured from the midpoint of the project.

(b) A contractor is not required to provide board and lodging:

(1) to a laborer, mechanic, or field surveyor who is a domiciled resident of the project area; or

(2) on a laborer, mechanic, or field surveyor's scheduled days off, when the person can reasonably travel between the project and the person's permanent residence; for the purposes of this paragraph, "scheduled day off" means a day in which a person does not perform work on-site, is not required to remain at or near the job location for the benefit of the contractor, and is informed of the day off at least seven days before the day off.

(c) Upon a contractor's written request, the commissioner may waive the requirements of (a) of this section where:

(1) the project is inaccessible by road in a two-wheel drive vehicle, but the laborer, mechanic, or field surveyor can reasonably travel between the project and the person's permanent residence within one hour; or

(2) a laborer, mechanic, or field surveyor is not a domiciled resident of the project area, but has established permanent residence, with the intent to remain indefinitely, within 65 road miles of the project, or for a highway project, the mid-point of the project.

8 AAC 30.054. Per diem instead of board and lodging. (a) A contractor may pay a laborer, mechanic, or field surveyor per diem instead of providing board and lodging, when the following conditions are met:

(1) the department determines that per diem instead of board and lodging is an established practice for the work classification; the department shall publish and periodically revise its determinations in the pamphlet *Laborers' and Mechanics' Minimum Rates of Pay*;

(2) the contractor pays each laborer, mechanic, or field surveyor the appropriate per diem rate as published and periodically revised in the pamphlet *Laborers' and Mechanics' Minimum Rates of Pay*; and

(3) the contractor pays the per diem to each laborer, mechanic, or field surveyor on the same day that wages are paid.

(b) A contractor may not pay per diem instead of board and lodging on a highway project located

- (1) west of Livengood on the Elliot Highway, AK-2;
- (2) on the Dalton Highway, AK-11;
- (3) north of milepost 20 on the Taylor Highway, AK-5;
- (4) east of Chicken on the Top of the World Highway; or
- (5) south of Tetlin Junction to the Alaska-Canada border on the Alaska Highway, AK-2.

8 AAC 30.056. Alternative arrangement. Upon a contractor’s written request, the commissioner may approve an alternative board and lodging or per diem arrangement, provided

- (1) the arrangement does not reduce the laborer, mechanic, or field surveyor’s wages below the prevailing wage rate; and
- (2) the laborer, mechanic, or field surveyor voluntarily enters into and signs the written arrangement; a labor organization representing laborers, mechanics, or field surveyors may enter into the written agreement on their behalf.

8 AAC 30.900. General definitions (selected excerpts only):

In this chapter and in AS 36

- (22) “domiciled resident” means a person living within 65 road miles of a public construction project, or in the case of a highway project, the mid-point of the project, for at least 12 consecutive months prior to the award of the public construction project;
- (23) “employed on the project” means the time period from the date the laborer, mechanic, or field surveyor first reports on-site to the project through the final date the person reports on-site to the project.

ADDITIONAL INFORMATION

PER DIEM

Notice: New regulations relating to board and lodging and per diem went into effect on November 25, 2018. The regulations provide a comprehensive set of requirements for the provision of board and lodging or per diem for workers on remote projects. Please refer to Alaska Administrative Code 8 AAC Chapter 30 and read the chapter carefully.

The Alaska Department of Labor and Workforce Development has determined that per diem is an established work practice for certain work classifications. These classifications are indicated throughout the Pamphlet by an asterisk (*) under the classification title. If all of the conditions of 8 AAC 30.054 are met, an employer may pay workers in these classifications per diem instead of providing board and lodging on a remote project.

Per Diem Rate: As of May 1st, 2019, the minimum per diem rate is \$100.00 per day, or part thereof, the worker is employed on the project. In the event that a contractor provides lodging facilities, but no meals, the department will accept a payment of \$48 per day for meals to meet the per diem requirements.

LABORER CLASSIFICATION CLARIFICATION

The laborer rates categorized in class code S1201-S1206 apply in one area of Alaska; the area that is south of N63 latitude and west of W138 Longitude. The laborer rates categorized in class code N1201-N1206 apply in two areas of Alaska; the Alaska areas north of N63 latitude and east of W138 longitude. The following graphic representations should assist with clarifying the applicable wage rate categories:

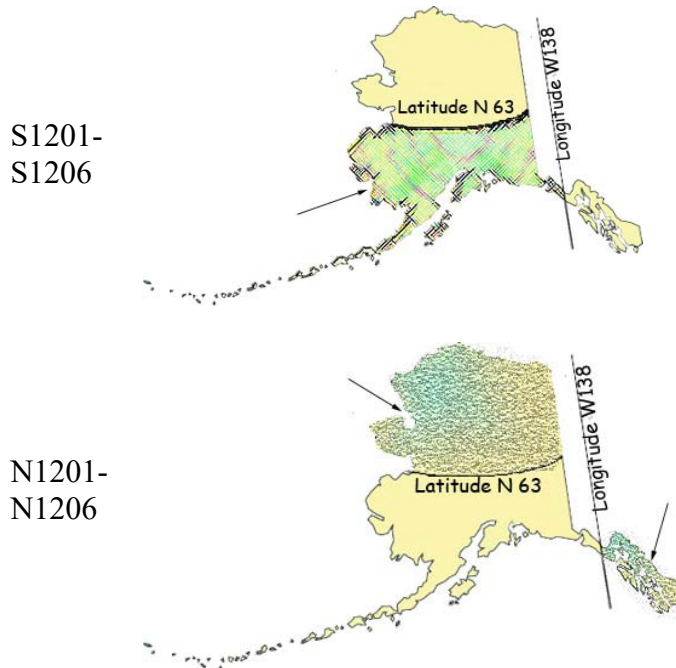

APPRENTICE RATES

Apprentice rates at less than the minimum prevailing rates may be paid to apprentices according to an apprentice program which has been registered and approved by the Commissioner of the Alaska Department of Labor and Workforce Development in writing or according to a bona fide apprenticeship program registered with the U.S. Department of Labor, Office of Apprenticeship Training. **Any employee listed on a payroll at an apprentice wage rate who is not registered as above shall be paid the journeyman prevailing minimum wage in that work classification.** Wage rates are based on prevailing crew makeup practices in Alaska and apply to work performed regardless of either the quality of the work performed by the employee or the titles or classifications which may be assigned to individual employees.

FRINGE BENEFIT PLANS

Contractors/subcontractors may compensate fringe benefits to their employees in any one of three methods. The fringe benefits may be paid into a union trust fund, into an approved benefit plan, or paid directly on the paycheck as gross wages.

Where fringe benefits are paid into approved plans, funds, or programs including union trust funds, the payments must be contributed at least monthly. If contractors submit their own payroll forms and are paying fringe benefits into approved plans, funds, or programs, the employer's certification must include, in addition to those requirements of 8 AAC 30.020(c), a statement that fringe benefit payments have been or will be paid at least monthly. Contractors who pay fringe benefits to a plan must ensure the plan is one approved by the Internal Revenue Service and that the plan meets the requirements of 8 AAC 30.025 (eff. 3/2/08) in order for payments to be credited toward the prevailing wage obligation.

SPECIAL PREVAILING WAGE RATE DETERMINATION

Special prevailing wage rate determinations may be requested for special projects or a special worker classification if the work to be performed does not conform to traditional public construction for which a prevailing wage rate has been established under 8 AAC 30.050(a) of this section. Requests for special wage rate determinations must be in writing and filed with the Commissioner at least 30 days before the award of the contract. An applicant for a special wage rate determination shall have the responsibility to support the necessity for the special rate. An application for a special wage rate determination filed under this section must contain:

- (1) a specification of the contract or project on which the special rates will apply and a description of the work to be performed;
- (2) a brief narrative explaining why special wage rates are necessary;
- (3) the job class or classes involved;
- (4) the special wage rates the applicant is requesting, including survey or other relevant wage data to support the requested rates;
- (5) the approximate number of employees who would be affected; and
- (6) any other information which might be helpful in determining if special wage rates are appropriate.

Requests made pursuant to the above should be addressed to:

Director
Alaska Department of Labor and Workforce Development
Labor Standards and Safety Division
Wage and Hour Administration
P.O. Box 111149
Juneau, AK 99811-1149

-or-

Email: statewide.wagehour@alaska.gov

EMPLOYMENT PREFERENCE INFORMATION

In October 2019, the Alaska Attorney General issued a formal opinion stating that the Alaska Statutes 36.10.150 of the State’s 90% Employment Preference law, also known as the Alaska Resident Hire law, violates both the U.S. and Alaska Constitutions. As a result, the state has stopped all enforcement activity.

A copy of the Attorney General opinion is found here:

http://law.alaska.gov/pdf/opinions/opinions_2019/19-005_AK-hire.pdf

Alaska Department of Labor and Workforce Development
Labor Standards and Safety Division
Wage and Hour Administration
Web site: <http://labor.state.ak.us/lss/pamp600.htm>

Anchorage

1251 Muldoon Road, Suite 113
Anchorage, Alaska 99504-2098
Phone: (907) 269-4900

Email:
statewide.wagehour@alaska.gov

Juneau

PO Box 111149
Juneau, Alaska 99811
Phone: (907) 465-4842

Email:
statewide.wagehour@alaska.gov

Fairbanks

Regional State Office Building
675 7th Ave., Station J-1
Fairbanks, Alaska 99701-4593
Phone: (907) 451-2886

Email:
statewide.wagehour@alaska.gov

LABOR STANDARDS AND SAFETY NOTICE REQUESTS

If you would like to receive Wage and Hour Administration or Mechanical Inspection **regulation notices** or **publications information**, they are available via electronic mail, by signing up in the GovDelivery System, <https://public.govdelivery.com/accounts/AKDOL/subscriber/new> and selecting topics *LSS – Wage and Hour – Forms and Publications*, *LSS – Mechanical Inspection Regulations*, or *LSS – Wage and Hour Regulations*.

Publications are also available online at <http://labor.alaska.gov/lss/home.htm>

DEBARMENT LIST

AS 36.05.090(b) states that “the state disbursing officer or the local fiscal officer shall distribute to all departments of the state government and to all political subdivisions of the state a list giving the names of persons who have disregarded their obligations to employees.”

A person appearing on the following debarment list and a firm, corporation, partnership, or association in which the person has an interest may not work as a contractor or subcontractor on a public construction contract for the state or a political subdivision of the state for three years from the date of debarment.

Company Name

Debarment Expires

Tim Banach, Individual
Boulder Creek Electric

February 23, 2021
February 23, 2021

Laborers' & Mechanics' Minimum Rates of Pay

Class Code	Classification of Laborers & Mechanics	BHR	H&W	PEN	TRN	Other	Benefits	THR
------------	--	-----	-----	-----	-----	-------	----------	-----

Boilermakers

*See per diem note on last page

A0101	Boilermaker (journeyman)	46.08	8.57	16.72	1.65	VAC 3.50	SAF 0.34	76.86
--------------	--------------------------	-------	------	-------	------	----------	----------	-------

Bricklayers & Blocklayers

*See per diem note on last page

A0201	Blocklayer	42.13	9.83	8.50	0.55	L&M 0.15	0.87	62.03
--------------	------------	-------	------	------	------	----------	------	-------

Bricklayer
 Marble or Stone Mason
 Refractory Worker (Firebrick, Plastic, Castable, and Gunitite Refractory Applications)
 Terrazzo Worker
 Tile Setter

A0202	Tuck Pointer Caulker	42.13	9.83	8.50	0.55	L&M 0.15	0.87	62.03
--------------	----------------------	-------	------	------	------	----------	------	-------

Cleaner (PCC)

A0203	Marble & Tile Finisher	35.96	9.83	8.50	0.55	L&M 0.15	0.87	55.86
--------------	------------------------	-------	------	------	------	----------	------	-------

Terrazzo Finisher

A0204	Torginal Applicator	40.10	9.83	8.50	0.55	L&M 0.15	0.87	60.00
--------------	---------------------	-------	------	------	------	----------	------	-------

Carpenters, Region I (North of 63 latitude)

*See per diem note on last page

N0301	Carpenter (journeyman)	38.34	10.08	15.23	1.10	L&M 0.10	SAF 0.10	64.95
--------------	------------------------	-------	-------	-------	------	----------	----------	-------

Lather/Drywall/Acoustical

Carpenters, Region II (South of N63 latitude)

*See per diem note on last page

S0301	Carpenter (journeyman)	38.34	10.08	15.77	1.10	L&M 0.10	SAF 0.10	65.49
--------------	------------------------	-------	-------	-------	------	----------	----------	-------

Lather/Drywall/Acoustical

Cement Masons

*See per diem note on last page

Wage benefits key: BHR=basic hourly rate; H&W=health and welfare; IAF=industry advancement fund; LEG=legal fund; L&M=labor/management fund; PEN=pension fund; SAF=safety; SUI=supplemental unemployment insurance; S&L=SUI & LEG combined; TRN=training; THR=total hourly rate; VAC=vacation

Cement Masons

*See per diem note on last page

A0401	Group I, including:	38.38	8.70	11.80	1.43		L&M 0.10	60.41
--------------	---------------------	-------	------	-------	------	--	------------------------	-------

- Application of Sealing Compound
- Application of Underlayment
- Building, General
- Cement Mason (journeyman)
- Concrete
- Concrete Paving
- Curb & Gutter, Sidewalk
- Curing of All Concrete
- Grouting & Caulking of Tilt-Up Panels
- Grouting of All Plates
- Patching Concrete
- Screed Pin Setter
- Spackling/Skim Coating

A0402	Group II, including:	38.38	8.70	11.80	1.43		L&M 0.10	60.41
--------------	----------------------	-------	------	-------	------	--	------------------------	-------

- Form Setter

A0403	Group III, including:	38.38	8.70	11.80	1.43		L&M 0.10	60.41
--------------	-----------------------	-------	------	-------	------	--	------------------------	-------

- Concrete Saw (self-powered)
- Curb & Gutter Machine
- Floor Grinder
- Pneumatic Power Tools
- Power Chipping & Bushing
- Sand Blasting Architectural Finish
- Screed & Rodding Machine Operator
- Troweling Machine Operator

A0404	Group IV, including:	38.38	8.70	11.80	1.43		L&M 0.10	60.41
--------------	----------------------	-------	------	-------	------	--	------------------------	-------

- Application of All Composition Mastic
- Application of All Epoxy Material
- Application of All Plastic Material
- Finish Colored Concrete
- Gunite Nozzleman
- Hand Powered Grinder
- Tunnel Worker

A0405	Group V, including:	38.38	8.70	11.80	1.43		L&M 0.10	60.41
--------------	---------------------	-------	------	-------	------	--	------------------------	-------

- Plasterer

Wage benefits key: BHR=basic hourly rate; H&W=health and welfare; IAF=industry advancement fund; LEG=legal fund; L&M=labor/management fund; PEN=pension fund; SAF=safety; SUI=supplemental unemployment insurance; S&L=SUI & LEG combined; TRN=training; THR=total hourly rate; VAC=vacation

Class Code	Classification of Laborers & Mechanics	BHR	H&W	PEN	TRN	Other	Benefits	THR
------------	--	-----	-----	-----	-----	-------	----------	-----

Culinary Workers

A0501	Baker/Cook	28.37	7.31	7.56			LEG	43.24
A0503	General Helper	25.05	7.31	7.56			LEG	39.92
	Housekeeper							
	Janitor							
	Kitchen Helper							
A0504	Head Cook	28.97	7.31	7.56			LEG	43.84
A0505	Head Housekeeper	25.45	7.31	7.56			LEG	40.32
	Head Kitchen Help							

Dredgemen
*See per diem note on last page

A0601	Assistant Engineer	40.76	10.35	13.00	1.00	0.10	0.05	L&M 65.26
	Craneman							
	Electrical Generator Operator (primary pump/power barge/dredge)							
	Engineer							
	Welder							
A0602	Assistant Mate (deckhand)	39.60	10.35	13.00	1.00	0.10	0.05	L&M 64.10
A0603	Fireman	40.04	10.35	13.00	1.00	0.10	0.05	L&M 64.54
A0605	Leverman Clamshell	43.29	10.35	13.00	1.00	0.10	0.05	L&M 67.79
A0606	Leverman Hydraulic	41.53	10.35	13.00	1.00	0.10	0.05	L&M 66.03
A0607	Mate & Boatman	40.76	10.35	13.00	1.00	0.10	0.05	L&M 65.26
A0608	Oiler (dredge)	40.04	10.35	13.00	1.00	0.10	0.05	L&M 64.54

Electricians
*See per diem note on last page

A0701	Inside Cable Splicer	41.27	13.90	13.88	0.95	0.20	0.15	L&M LEG 70.35
--------------	----------------------	-------	-------	-------	------	------	------	------------------------------------

Wage benefits key: BHR=basic hourly rate; H&W=health and welfare; IAF=industry advancement fund; LEG=legal fund; L&M=labor/management fund; PEN=pension fund; SAF=safety; SUI=supplemental unemployment insurance; S&L=SUI & LEG combined; TRN=training; THR=total hourly rate; VAC=vacation

Class Code	Classification of Laborers & Mechanics	BHR	H&W	PEN	TRN	Other	Benefits	THR	
Electricians									
*See per diem note on last page									
A0702	Inside Journeyman Wireman, including: Technicians (including use of drones in electrical construction)	40.94	13.90	14.12	0.95		L&M 0.20	LEG 0.15	70.26
A0703	Power Cable Splicer	57.79	13.90	18.92	0.95		L&M 0.20	LEG 0.15	91.91
A0704	Tele Com Cable Splicer	50.53	13.90	16.17	0.95		L&M 0.20	LEG 0.15	81.90
A0705	Power Journeyman Lineman, including: Power Equipment Operator Technician (including use of drones in electrical construction)	56.04	13.90	18.87	0.95		L&M 0.20	LEG 0.15	90.11
A0706	Tele Com Journeyman Lineman, including: Technician (including use of drones in telecommunications construction) Tele Com Equipment Operator	48.78	13.90	16.11	0.95		L&M 0.20	LEG 0.15	80.09
A0707	Straight Line Installer - Repairman	48.78	13.90	16.11	0.95		L&M 0.20	LEG 0.15	80.09
A0708	Powderman	54.04	13.90	18.81	0.95		L&M 0.20	LEG 0.15	88.05
A0710	Material Handler	26.57	13.33	4.80	0.15		L&M 0.15	LEG 0.15	45.15
A0712	Tree Trimmer Groundman	28.37	13.90	12.59	0.15		L&M 0.15	LEG 0.15	55.31
A0713	Journeyman Tree Trimmer	37.30	13.90	12.86	0.15		L&M 0.15	LEG 0.15	64.51
A0714	Vegetation Control Sprayer	40.85	13.90	12.97	0.15		L&M 0.15	LEG 0.15	68.17
A0715	Inside Journeyman Communications CO/PBX	39.52	13.90	13.83	0.95		L&M 0.20	LEG 0.15	68.55

Elevator Workers
*See per diem note on last page

A0802	Elevator Constructor	41.38	15.73	18.41	0.63		L&M 0.48	VAC 4.59	81.22
A0803	Elevator Constructor Mechanic	59.11	15.73	18.41	0.63		L&M 0.48	VAC 6.56	100.92

Wage benefits key: BHR=basic hourly rate; H&W=health and welfare; IAF=industry advancement fund; LEG=legal fund; L&M=labor/management fund; PEN=pension fund; SAF=safety; SUI=supplemental unemployment insurance; S&L=SUI & LEG combined; TRN=training; THR=total hourly rate; VAC=vacation

Class Code	Classification of Laborers & Mechanics	BHR	H&W	PEN	TRN	Other	Benefits	THR
------------	--	-----	-----	-----	-----	-------	----------	-----

Heat & Frost Insulators/Asbestos Workers

*See per diem note on last page

A0902	Asbestos Abatement-Mechanical Systems	38.68	9.24	11.01	1.20		SAF 0.12	60.25
A0903	Asbestos Abatement/General Demolition All Systems	38.68	9.24	11.01	1.20		SAF 0.12	60.25
A0904	Insulator, Group II	38.68	9.24	11.01	1.20		SAF 0.12	60.25
A0905	Fire Stop	38.68	9.24	11.01	1.20		SAF 0.12	60.25

IronWorkers

*See per diem note on last page

A1101	Ironworkers, including:	38.75	9.03	22.88	0.72		L&M 0.20	IAF 0.36	71.94
	Bender Operators								
	Bridge & Structural								
	Hangar Doors								
	Hollow Metal Doors								
	Industrial Doors								
	Machinery Mover								
	Ornamental								
	Reinforcing								
	Rigger								
	Sheeter								
	Signalman								
	Stage Rigger								
	Toxic Haz-Mat Work								
	Welder								
A1102	Helicopter	39.75	9.03	22.88	0.72		L&M 0.20	IAF 0.36	72.94
	Tower (energy producing windmill type towers to include nacelle and blades)								
A1103	Fence/Barrier Installer	35.25	9.03	22.53	0.72		L&M 0.20	IAF 0.36	68.09
A1104	Guard Rail Layout Man	35.99	9.03	22.53	0.72		L&M 0.20	IAF 0.36	68.83
A1105	Guard Rail Installer	36.25	9.03	22.53	0.72		L&M 0.20	IAF 0.36	69.09

Laborers (The Alaska areas north of N63 latitude and east of W138 longitude)

*See per diem note on last page

Wage benefits key: BHR=basic hourly rate; H&W=health and welfare; IAF=industry advancement fund; LEG=legal fund; L&M=labor/management fund; PEN=pension fund; SAF=safety; SUI=supplemental unemployment insurance; S&L=SUI & LEG combined; TRN=training; THR=total hourly rate; VAC=vacation

Laborers (The Alaska areas north of N63 latitude and east of W138 longitude)

*See per diem note on last page

						L&M	LEG	
N1201	Group I, including:	31.71	8.95	17.81	1.30	0.20	0.20	60.17
	Asphalt Worker (shovelman, plant crew)							
	Brush Cutter							
	Camp Maintenance Laborer							
	Carpenter Tender or Helper							
	Choke Setter, Hook Tender, Rigger, Signalman							
	Concrete Labor (curb & gutter, chute handler, curing, grouting, screeding)							
	Crusher Plant Laborer							
	Demolition Laborer							
	Ditch Digger							
	Dumpman							
	Environmental Laborer (hazard/toxic waste, oil spill)							
	Fence Installer							
	Fire Watch Laborer							
	Flagman							
	Form Stripper							
	General Laborer							
	Guardrail Laborer, Bridge Rail Installer							
	Hydro-seeder Nozzleman							
	Laborer, Building							
	Landscaper or Planter							
	Laying of Mortarless Decorative Block (retaining walls, flowered decorative block 4 feet or less - highway or landscape work)							
	Material Handler							
	Pneumatic or Power Tools							
	Portable or Chemical Toilet Serviceman							
	Pump Man or Mixer Man							
	Railroad Track Laborer							
	Sandblast, Pot Tender							
	Saw Tender							
	Slurry Work							
	Steam Cleaner Operator							
	Steam Point or Water Jet Operator							
	Storm Water Pollution Protection Plan Worker (SWPPP Worker - erosion and sediment control Laborer)							
	Tank Cleaning							
	Utiliwalk & Utilidor Laborer							
	Watchman (construction projects)							
	Window Cleaner							

						L&M	LEG	
N1202	Group II, including:	32.71	8.95	17.81	1.30	0.20	0.20	61.17

Burning & Cutting Torch

Wage benefits key: BHR=basic hourly rate; H&W=health and welfare; IAF=industry advancement fund; LEG=legal fund; L&M=labor/management fund; PEN=pension fund; SAF=safety; SUI=supplemental unemployment insurance; S&L=SUI & LEG combined; TRN=training; THR=total hourly rate; VAC=vacation

Laborers (The Alaska areas north of N63 latitude and east of W138 longitude)

*See per diem note on last page

						L&M	LEG	
N1202	Group II, including:	32.71	8.95	17.81	1.30	0.20	0.20	61.17
	Cement or Lime Dumper or Handler (sack or bulk)							
	Certified Erosion Sediment Control Lead (CESCL Laborer)							
	Choker Splicer							
	Chucktender (wagon, air-track & hydraulic drills)							
	Concrete Laborer (power buggy, concrete saws, pumpcrete nozzleman, vibratorman)							
	Culvert Pipe Laborer							
	Cured Inplace Pipelayer							
	Environmental Laborer (asbestos, marine work)							
	Floor Preparation, Core Drilling							
	Foam Gun or Foam Machine Operator							
	Green Cutter (dam work)							
	Guniting Operator							
	Hod Carrier							
	Jackhammer/Chipping Gun or Pavement Breaker							
	Laser Instrument Operator							
	Laying of Mortarless Decorative Block (retaining walls, flowered decorative block over 4 feet - highway or landscape work)							
	Mason Tender & Mud Mixer (sewer work)							
	Pilot Car							
	Pipelayer Helper							
	Plasterer, Bricklayer & Cement Finisher Tender							
	Powderman Helper							
	Power Saw Operator							
	Railroad Switch Layout Laborer							
	Sandblaster							
	Scaffold Building & Erecting							
	Sewer Caulker							
	Sewer Plant Maintenance Man							
	Thermal Plastic Applicator							
	Timber Faller, Chainsaw Operator, Filer							
	Timberman							

						L&M	LEG	
N1203	Group III, including:	33.61	8.95	17.81	1.30	0.20	0.20	62.07
	Bit Grinder							
	Camera/Tool/Video Operator							
	Guardrail Machine Operator							
	High Rigger & Tree Topper							
	High Scaler							
	Multiplate							
	Plastic Welding							

Wage benefits key: BHR=basic hourly rate; H&W=health and welfare; IAF=industry advancement fund; LEG=legal fund; L&M=labor/management fund; PEN=pension fund; SAF=safety; SUI=supplemental unemployment insurance; S&L=SUI & LEG combined; TRN=training; THR=total hourly rate; VAC=vacation

Class Code	Classification of Laborers & Mechanics	BHR	H&W	PEN	TRN	Other	Benefits	THR
------------	--	-----	-----	-----	-----	-------	----------	-----

Laborers (The Alaska areas north of N63 latitude and east of W138 longitude)

*See per diem note on last page

N1203	Group III, including:	33.61	8.95	17.81	1.30	L&M	LEG	62.07
--------------	-----------------------	-------	------	-------	------	----------------	------------	-------

- Slurry Seal Squeegee Man
- Traffic Control Supervisor
- Welding Certified (in connection with laborer's work)

N1204	Group IIIA	36.89	8.95	17.81	1.30	L&M	LEG	65.35
--------------	------------	-------	------	-------	------	----------------	------------	-------

- Asphalt Raker, Asphalt Belly Dump Lay Down
- Drill Doctor (in the field)
- Driller (including, but not limited to wagon drills, air-track drills, hydraulic drills)
- Pioneer Drilling & Drilling Off Tugger (all type drills)
- Pipelayers
- Powderman (Employee Possessor)
- Storm Water Pollution Protection Plan Specialist (SWPPP Specialist)
- Traffic Control Supervisor, DOT Qualified

N1205	Group IV	21.28	8.95	17.81	1.30	L&M	LEG	49.74
--------------	----------	-------	------	-------	------	----------------	------------	-------

- Final Building Cleanup
- Permanent Yard Worker

N1206	Group IIIB	40.68	6.24	17.81	1.30	L&M	LEG	66.43
--------------	------------	-------	------	-------	------	----------------	------------	-------

- Driller (including, but not limited to wagon drills, air-track drills, hydraulic drills)(over 5,000 hours)
- Federal Powderman (Responsible Person in Charge)
- Grade Checking (setting or transferring of grade marks, line and grade, GPS, drones)
- Pioneer Drilling & Drilling Off Tugger (all type drills)(over 5,000 hours)
- Stake Hopper

Laborers (The area that is south of N63 latitude and west of W138 longitude)

*See per diem note on last page

S1201	Group I, including:	31.71	8.95	17.81	1.30	L&M	LEG	60.17
--------------	---------------------	-------	------	-------	------	----------------	------------	-------

- Asphalt Worker (shovelman, plant crew)
- Brush Cutter
- Camp Maintenance Laborer
- Carpenter Tender or Helper
- Choke Setter, Hook Tender, Rigger, Signalman
- Concrete Labor (curb & gutter, chute handler, curing, grouting, screeding)
- Crusher Plant Laborer
- Demolition Laborer

Wage benefits key: BHR=basic hourly rate; H&W=health and welfare; IAF=industry advancement fund; LEG=legal fund; L&M=labor/management fund; PEN=pension fund; SAF=safety; SUI=supplemental unemployment insurance; S&L=SUI & LEG combined; TRN=training; THR=total hourly rate; VAC=vacation

Laborers (The area that is south of N63 latitude and west of W138 longitude)

*See per diem note on last page

						L&M	LEG	
S1201	Group I, including:	31.71	8.95	17.81	1.30	0.20	0.20	60.17
	Ditch Digger							
	Dumpman							
	Environmental Laborer (hazard/toxic waste, oil spill)							
	Fence Installer							
	Fire Watch Laborer							
	Flagman							
	Form Stripper							
	General Laborer							
	Guardrail Laborer, Bridge Rail Installer							
	Hydro-seeder Nozzleman							
	Laborer, Building							
	Landscaper or Planter							
	Laying of Mortarless Decorative Block (retaining walls, flowered decorative block 4 feet or less - highway or landscape work)							
	Material Handler							
	Pneumatic or Power Tools							
	Portable or Chemical Toilet Serviceman							
	Pump Man or Mixer Man							
	Railroad Track Laborer							
	Sandblast, Pot Tender							
	Saw Tender							
	Slurry Work							
	Steam Cleaner Operator							
	Steam Point or Water Jet Operator							
	Storm Water Pollution Protection Plan Worker (SWPPP Worker - erosion and sediment control Laborer)							
	Tank Cleaning							
	Utiliwalk & Utilidor Laborer							
	Watchman (construction projects)							
	Window Cleaner							

						L&M	LEG	
S1202	Group II, including:	32.71	8.95	17.81	1.30	0.20	0.20	61.17
	Burning & Cutting Torch							
	Cement or Lime Dumper or Handler (sack or bulk)							
	Certified Erosion Sediment Control Lead (CESCL Laborer)							
	Choker Splicer							
	Chucktender (wagon, air-track & hydraulic drills)							
	Concrete Laborer (power buggy, concrete saws, pumpcrete nozzleman, vibratorman)							
	Culvert Pipe Laborer							
	Cured Inplace Pipelayer							

Wage benefits key: BHR=basic hourly rate; H&W=health and welfare; IAF=industry advancement fund; LEG=legal fund; L&M=labor/management fund; PEN=pension fund; SAF=safety; SUI=supplemental unemployment insurance; S&L=SUI & LEG combined; TRN=training; THR=total hourly rate; VAC=vacation

Laborers (The area that is south of N63 latitude and west of W138 longitude)

*See per diem note on last page

						L&M	LEG	
S1202	Group II, including:	32.71	8.95	17.81	1.30	0.20	0.20	61.17

- Environmental Laborer (asbestos, marine work)
- Floor Preparation, Core Drilling
- Foam Gun or Foam Machine Operator
- Green Cutter (dam work)
- Gunite Operator
- Hod Carrier
- Jackhammer/Chipping Gun or Pavement Breaker
- Laser Instrument Operator
- Laying of Mortarless Decorative Block (retaining walls, flowered decorative block over 4 feet - highway or landscape work)
- Mason Tender & Mud Mixer (sewer work)
- Pilot Car
- Pipelayer Helper
- Plasterer, Bricklayer & Cement Finisher Tender
- Powderman Helper
- Power Saw Operator
- Railroad Switch Layout Laborer
- Sandblaster
- Scaffold Building & Erecting
- Sewer Caulker
- Sewer Plant Maintenance Man
- Thermal Plastic Applicator
- Timber Faller, Chainsaw Operator, Filer
- Timberman

						L&M	LEG	
S1203	Group III, including:	33.61	8.95	17.81	1.30	0.20	0.20	62.07

- Bit Grinder
- Camera/Tool/Video Operator
- Guardrail Machine Operator
- High Rigger & Tree Topper
- High Scaler
- Multiplate
- Plastic Welding
- Slurry Seal Squeegee Man
- Traffic Control Supervisor
- Welding Certified (in connection with laborer's work)

						L&M	LEG	
S1204	Group IIIA	36.89	8.95	17.81	1.30	0.20	0.20	65.35

- Asphalt Raker, Asphalt Belly Dump Lay Down
- Drill Doctor (in the field)

Wage benefits key: BHR=basic hourly rate; H&W=health and welfare; IAF=industry advancement fund; LEG=legal fund; L&M=labor/management fund; PEN=pension fund; SAF=safety; SUI=supplemental unemployment insurance; S&L=SUI & LEG combined; TRN=training; THR=total hourly rate; VAC=vacation

Class Code	Classification of Laborers & Mechanics	BHR	H&W	PEN	TRN	Other	Benefits	THR
------------	--	-----	-----	-----	-----	-------	----------	-----

Laborers (The area that is south of N63 latitude and west of W138 longitude)

*See per diem note on last page

S1204	Group IIIA	36.89	8.95	17.81	1.30	L&M	LEG	65.35
--------------	------------	-------	------	-------	------	----------------	------------	-------

- Driller (including, but not limited to wagon drills, air-track drills, hydraulic drills)
- Pioneer Drilling & Drilling Off Tugger (all type drills)
- Pipelayers
- Powderman (Employee Possessor)
- Storm Water Pollution Protection Plan Specialist (SWPPP Specialist)
- Traffic Control Supervisor, DOT Qualified

S1205	Group IV	21.28	8.95	17.81	1.30	L&M	LEG	49.74
--------------	----------	-------	------	-------	------	----------------	------------	-------

- Final Building Cleanup
- Permanent Yard Worker

S1206	Group IIIB	40.68	6.24	17.81	1.30	L&M	LEG	66.43
--------------	------------	-------	------	-------	------	----------------	------------	-------

- Driller (including, but not limited to wagon drills, air-track drills, hydraulic drills)(over 5,000 hours)
- Federal Powderman (Responsible Person in Charge)
- Grade Checking (setting or transferring of grade marks, line and grade, GPS, drones)
- Pioneer Drilling & Drilling Off Tugger (all type drills)(over 5,000 hours)
- Stake Hopper

Millwrights

*See per diem note on last page

A1251	Millwright (journeyman)	37.64	10.08	12.28	1.10	L&M	0.05	61.55
--------------	-------------------------	-------	-------	-------	------	----------------	------	-------

A1252	Millwright Welder	38.64	10.08	12.28	1.10	L&M	0.05	62.55
--------------	-------------------	-------	-------	-------	------	----------------	------	-------

Painters, Region I (North of N63 latitude)

*See per diem note on last page

N1301	Group I, including:	33.11	8.59	13.50	1.08	L&M	0.07	56.35
--------------	---------------------	-------	------	-------	------	----------------	------	-------

- Brush
- General Painter
- Hand Taping
- Hazardous Material Handler
- Lead-Based Paint Abatement
- Roll

Wage benefits key: BHR=basic hourly rate; H&W=health and welfare; IAF=industry advancement fund; LEG=legal fund; L&M=labor/management fund; PEN=pension fund; SAF=safety; SUI=supplemental unemployment insurance; S&L=SUI & LEG combined; TRN=training; THR=total hourly rate; VAC=vacation

Painters, Region I (North of N63 latitude)

*See per diem note on last page

						L&M	
N1302	Group II, including:	33.63	8.59	13.50	1.08	0.07	56.87
	Bridge Painter						
	Epoxy Applicator						
	General Drywall Finisher						
	Hand/Spray Texturing						
	Industrial Coatings Specialist						
	Machine/Automatic Taping						
	Pot Tender						
	Sandblasting						
	Specialty Painter						
	Spray						
	Structural Steel Painter						
	Wallpaper/Vinyl Hanger						

N1304	Group IV, including:	39.76	8.59	16.37	1.05	0.05	65.82
	Glazier						
	Storefront/Automatic Door Mechanic						

N1305	Group V, including:	28.75	8.59	5.02	0.83	0.07	43.26
	Carpet Installer						
	Floor Coverer						
	Heat Weld/Cove Base						
	Linoleum/Soft Tile Installer						

Painters, Region II (South of N63 latitude)

*See per diem note on last page

						L&M	
S1301	Group I, including :	30.45	8.59	14.15	1.08	0.07	54.34
	Brush						
	General Painter						
	Hand Taping						
	Hazardous Material Handler						
	Lead-Based Paint Abatement						
	Roll						
	Spray						

						L&M	
S1302	Group II, including :	31.70	8.59	14.15	1.08	0.07	55.59
	General Drywall Finisher						
	Hand/Spray Texturing						
	Machine/Automatic Taping						

Wage benefits key: BHR=basic hourly rate; H&W=health and welfare; IAF=industry advancement fund; LEG=legal fund; L&M=labor/management fund; PEN=pension fund; SAF=safety; SUI=supplemental unemployment insurance; S&L=SUI & LEG combined; TRN=training; THR=total hourly rate; VAC=vacation

Class Code	Classification of Laborers & Mechanics	BHR	H&W	PEN	TRN	Other	Benefits	THR	
Painters, Region II (South of N63 latitude)									
*See per diem note on last page									
S1302	Group II, including :	31.70	8.59	14.15	1.08		L&M 0.07	55.59	
	Wallpaper/Vinyl Hanger								
S1303	Group III, including :	31.80	8.59	14.15	1.08		L&M 0.07	55.69	
	Bridge Painter								
	Epoxy Applicator								
	Industrial Coatings Specialist								
	Pot Tender								
	Sandblasting								
	Specialty Painter								
	Structural Steel Painter								
S1304	Group IV, including:	39.97	8.59	15.41	1.08		L&M 0.07	65.12	
	Glazier								
	Storefront/Automatic Door Mechanic								
S1305	Group V, including:	28.75	8.59	5.02	0.83		L&M 0.07	43.26	
	Carpet Installer								
	Floor Coverer								
	Heat Weld/Cove Base								
	Linoleum/Soft Tile Installer								
Piledrivers									
*See per diem note on last page									
A1401	Piledriver	38.34	10.08	15.23	1.10		L&M 0.10	IAF 0.10	64.95
	Assistant Dive Tender								
	Carpenter/Piledriver								
	Rigger								
	Sheet Stabber								
	Skiff Operator								
A1402	Piledriver-Welder/Toxic Worker	39.34	10.08	15.23	1.10		L&M 0.10	IAF 0.10	65.95
A1403	Remotely Operated Vehicle Pilot/Technician	42.65	10.08	15.23	1.10		L&M 0.10	IAF 0.10	69.26
	Single Atmosphere Suit, Bell or Submersible Pilot								
A1404	Diver (working) **See note on last page	82.45	10.08	15.23	1.10		L&M 0.10	IAF 0.10	109.06

Wage benefits key: BHR=basic hourly rate; H&W=health and welfare; IAF=industry advancement fund; LEG=legal fund; L&M=labor/management fund; PEN=pension fund; SAF=safety; SUI=supplemental unemployment insurance; S&L=SUI & LEG combined; TRN=training; THR=total hourly rate; VAC=vacation

Class Code	Classification of Laborers & Mechanics	BHR	H&W	PEN	TRN	Other	Benefits	THR
------------	--	-----	-----	-----	-----	-------	----------	-----

Piledrivers
*See per diem note on last page

A1405	Diver (standby) **See note on last page	42.65	10.08	15.23	1.10	L&M	IAF	69.26
A1406	Dive Tender **See note on last page	41.65	10.08	15.23	1.10	L&M	IAF	68.26
A1407	Welder (American Welding Society, Certified Welding Inspector)	43.90	10.08	15.23	1.10	L&M	IAF	70.51

Plumbers, Region I (North of N63 latitude)
*See per diem note on last page

N1501	Journeyman Pipefitter	41.46	9.75	17.00	1.40	L&M	S&L	70.26
	Plumber							
	Welder							

Plumbers, Region II (South of N63 latitude)
*See per diem note on last page

S1501	Journeyman Pipefitter	40.00	10.73	15.02	1.45	L&M		67.40
	Plumber							
	Welder							

Plumbers, Region IIA (1st Judicial District)
*See per diem note on last page

X1501	Journeyman Pipefitter	38.82	13.37	11.75	2.50	L&M		66.68
	Plumber							
	Welder							

Power Equipment Operators
*See per diem note on last page

A1601	Group I, including:	41.53	10.35	13.00	1.00	L&M		66.03
	Asphalt Roller: Breakdown, Intermediate, and Finish							
	Back Filler							
	Barrier Machine (Zipper)							
	Beltcrete with Power Pack & similar conveyors							
	Bending Machine							
	Boat Coxswain							
	Bulldozer							
	Cableways, Highlines & Cablecars							

Wage benefits key: BHR=basic hourly rate; H&W=health and welfare; IAF=industry advancement fund; LEG=legal fund; L&M=labor/management fund; PEN=pension fund; SAF=safety; SUI=supplemental unemployment insurance; S&L=SUI & LEG combined; TRN=training; THR=total hourly rate; VAC=vacation

Power Equipment Operators

*See per diem note on last page

							L&M		
A1601	Group I, including:	41.53	10.35	13.00	1.00	0.10	0.05	66.03	
	Cleaning Machine								
	Coating Machine								
	Concrete Hydro Blaster								
	Cranes (45 tons & under or 150 feet of boom & under (including jib & attachments))								
	(a) Hydralifts or Transporters, (all track or truck type)								
	(b) Derricks								
	(c) Overhead								
	Crushers								
	Deck Winches, Double Drum								
	Ditching or Trenching Machine (16 inch or over)								
	Drag Scraper, Yarder, and similar types								
	Drilling Machines, Core, Cable, Rotary and Exploration								
	Finishing Machine Operator, Concrete Paving, Laser Screed, Sidewalk, Curb & Gutter Machine								
	Grade Checker and/or Line and Grade including Drone								
	Helicopters								
	Hover Craft, Flex Craft, Loadmaster, Air Cushion, All-Terrain Vehicle, Rollagon, Bargecable, Nodwell, & Snow Cat								
	Hydro Ax, Feller Buncher & similar								
	Hydro Excavation (Vac-Truck and Similar)								
	Loaders (2 1/2 yards through 5 yards, including all attachments):								
	(a) Forklifts (with telescopic boom & swing attachment)								
	(b) Front End & Overhead, (2-1/2 yards through 5 yards)								
	(c) Loaders, (with forks or pipe clamp)								
	(d) Loaders, (elevating belt type, Euclid & similar types)								
	Material Transfer Vehicle (Elevating Grader, Pickup Machine, and similar types)								
	Mechanic, Welder, Bodyman, Electrical, Camp & Maintenance Engineer								
	Micro Tunneling Machine								
	Mixers: Mobile type with hoist combination								
	Motor Patrol Grader								
	Mucking Machine: Mole, Tunnel Drill, Horizontal/Directional Drill Operator and/or Shield								
	Off-Road Hauler (including Articulating and Haul Trucks)								
	Operator on Dredges								
	Piledriver Engineer, L.B. Foster, Puller or similar paving breaker								
	Plant Operator (Asphalt & Concrete)								
	Power Plant, Turbine Operator 200 k.w & over (power plants or combination of power units over 300 k.w.)								
	Remote Controlled Equipment								
	Scraper (through 40 yards)								

Wage benefits key: BHR=basic hourly rate; H&W=health and welfare; IAF=industry advancement fund; LEG=legal fund; L&M=labor/management fund; PEN=pension fund; SAF=safety; SUI=supplemental unemployment insurance; S&L=SUI & LEG combined; TRN=training; THR=total hourly rate; VAC=vacation

Power Equipment Operators

*See per diem note on last page

A1601	Group I, including:	41.53	10.35	13.00	1.00	0.10	0.05	66.03
--------------	---------------------	-------	-------	-------	------	------	------	-------

- Service Oiler/Service Engineer
- Shot Blast Machine
- Shovels, Backhoes, Excavators with all attachments, and Gradealls (3 yards & under)
- Sideboom (under 45 tons)
- Sub Grader (Gurries & similar types)
- Tack Tractor
- Truck Mounted Concrete Pump, Conveyor/Tele-belt, & Creter
- Wate Kote Machine

A1602	Group IA, including:	43.29	10.35	13.00	1.00	0.10	0.05	67.79
--------------	----------------------	-------	-------	-------	------	------	------	-------

- Camera/Tool/Video Operator (Slipline)
- Certified Welder, Electrical Mechanic, Camp Maintenance Engineer, Mechanic (over 10,000 hours)
- Cranes (over 45 tons or 150 feet including jib & attachments)
 - (a) Clamshells & Draglines (over 3 yards)
 - (b) Tower Cranes
- Licensed Water/Waste Water Treatment Operator
- Loaders (over 5 yards)
- Motor Patrol Grader, Dozer, Grade Tractor (finish: when finishing to final grade and/or to hubs, or for asphalt)
- Power Plants (1000 k.w. & over)
- Profiler, Reclaimer, and Roto-Mill
- Quad
- Scrapers (over 40 yards)
- Screed
- Shovels, Backhoes, Excavators with all attachments (over 3 yards)
- Sidebooms (over 45 tons)
- Slip Form Paver, C.M.I. & similar types
- Topside (Asphalt Paver, Slurry machine, Spreaders, and similar types)

A1603	Group II, including:	40.76	10.35	13.00	1.00	0.10	0.05	65.26
--------------	----------------------	-------	-------	-------	------	------	------	-------

- Boiler - Fireman
- Cement Hogs & Concrete Pump Operator
- Conveyors (except those listed in Group I)
- Hoists on Steel Erection, Towermobiles & Air Tuggers
- Horizontal/Directional Drill Locator
- Locomotives, Rod & Geared Engines
- Mixers
- Screening, Washing Plant
- Sideboom (cradling rock drill, regardless of size)

Wage benefits key: BHR=basic hourly rate; H&W=health and welfare; IAF=industry advancement fund; LEG=legal fund; L&M=labor/management fund; PEN=pension fund; SAF=safety; SUI=supplemental unemployment insurance; S&L=SUI & LEG combined; TRN=training; THR=total hourly rate; VAC=vacation

Power Equipment Operators
 *See per diem note on last page

A1603	Group II, including:	40.76	10.35	13.00	1.00	0.10	0.05	65.26
	Skidder							
	Trenching Machines (under 16 inches)							
	Water/Waste Water Treatment Operator							

A1604	Group III, including:	40.04	10.35	13.00	1.00	0.10	0.05	64.54
	"A" Frame Trucks, Deck Winches							
	Bombardier (tack or tow rig)							
	Boring Machine							
	Brooms, Power (sweeper, elevator, vacuum, or similar)							
	Bump Cutter							
	Compressor							
	Farm Tractor							
	Forklift, Industrial Type							
	Gin Truck or Winch Truck (with poles when used for hoisting)							
	Hoists, Air Tuggers, Elevators							
	Loaders:							
	(a) Elevating-Athey, Barber Greene & similar types							
	(b) Forklifts or Lumber Carrier (on construction job sites)							
	(c) Forklifts, (with tower)							
	(d) Overhead & Front End, (under 2-1/2 yards)							
	Locomotives: Dinkey (air, steam, gas & electric) Speeders							
	Mechanics, Light Duty							
	Oil, Blower Distribution							
	Posthole Digger, Mechanical							
	Pot Fireman (power agitated)							
	Power Plant, Turbine Operator, (under 200 k.w.)							
	Pumps, Water							
	Roller (other than Asphalt)							
	Saws, Concrete							
	Skid Hustler							
	Skid Steer (with all attachments)							
	Stake Hopper							
	Straightening Machine							
	Tow Tractor							

A1605	Group IV, including:	33.83	10.35	13.00	1.00	0.10	0.05	58.33
	Crane Assistant Engineer/Rig Oiler							
	Drill Helper							
	Parts & Equipment Coordinator							
	Spotter							

Wage benefits key: BHR=basic hourly rate; H&W=health and welfare; IAF=industry advancement fund; LEG=legal fund; L&M=labor/management fund; PEN=pension fund; SAF=safety; SUI=supplemental unemployment insurance; S&L=SUI & LEG combined; TRN=training; THR=total hourly rate; VAC=vacation

Power Equipment Operators
 *See per diem note on last page

A1605	Group IV, including:	33.83	10.35	13.00	1.00		L&M	
	Steam Cleaner					0.10	0.05	58.33
	Swamper (on trenching machines or shovel type equipment)							

Roofers
 *See per diem note on last page

A1701	Roofer & Waterproofer	44.62	11.75	3.91	0.81		L&M	
						0.10	0.06	61.25
A1702	Roofer Material Handler	31.23	11.75	3.91	0.81		L&M	
						0.10	0.06	47.86

Sheet Metal Workers, Region I (North of N63 latitude)
 *See per diem note on last page

N1801	Sheet Metal Journeyman	48.04	11.20	13.61	1.65		L&M	
	Air Balancing and duct cleaning of HVAC systems					0.12		74.62
	Brazing, soldering or welding of metals							
	Demolition of sheet metal HVAC systems							
	Fabrication and installation of exterior wall sheathing, siding, metal roofing, flashing, decking and architectural sheet metal work							
	Fabrication and installation of heating, ventilation and air conditioning ducts and equipment							
	Fabrication and installation of louvers and hoods							
	Fabrication and installation of sheet metal lagging							
	Fabrication and installation of stainless steel commercial or industrial food service equipment							
	Manufacture, fabrication assembly, installation and alteration of all ferrous and nonferrous metal work							
	Metal lavatory partitions							
	Preparation of drawings taken from architectural and engineering plans required for fabrication and erection of sheet metal work							
	Sheet Metal shelving							
	Sheet Metal venting, chimneys and breaching							
	Skylight installation							

Sheet Metal Workers, Region II (South of N63 latitude)
 *See per diem note on last page

S1801	Sheet Metal Journeyman	42.70	11.20	13.89	1.68		L&M	
	Air Balancing and duct cleaning of HVAC systems					0.43		69.90
	Brazing, soldering or welding of metals							

Wage benefits key: BHR=basic hourly rate; H&W=health and welfare; IAF=industry advancement fund; LEG=legal fund; L&M=labor/management fund; PEN=pension fund; SAF=safety; SUI=supplemental unemployment insurance; S&L=SUI & LEG combined; TRN=training; THR=total hourly rate; VAC=vacation

Class Code	Classification of Laborers & Mechanics	BHR	H&W	PEN	TRN	Other	L&M	THR
------------	--	-----	-----	-----	-----	-------	-----	-----

Sheet Metal Workers, Region II (South of N63 latitude)

*See per diem note on last page

S1801	Sheet Metal Journeyman	42.70	11.20	13.89	1.68		L&M 0.43	69.90
--------------	------------------------	-------	-------	-------	------	--	------------------------	-------

- Demolition of sheet metal HVAC systems
- Fabrication and installation of exterior wall sheathing, siding, metal roofing, flashing, decking and architectural sheet metal work
- Fabrication and installation of heating, ventilation and air conditioning ducts and equipment
- Fabrication and installation of louvers and hoods
- Fabrication and installation of sheet metal lagging
- Fabrication and installation of stainless steel commercial or industrial food service equipment
- Manufacture, fabrication assembly, installation and alteration of all ferrous and nonferrous metal work
- Metal lavatory partitions
- Preparation of drawings taken from architectural and engineering plans required for fabrication and erection of sheet metal work
- Sheet Metal shelving
- Sheet Metal venting, chimneys and breaching
- Skylight installation

Sprinkler Fitters

*See per diem note on last page

A1901	Sprinkler Fitter	47.35	10.23	16.15	0.52		L&M 0.25	74.50
--------------	------------------	-------	-------	-------	------	--	------------------------	-------

Surveyors

*See per diem note on last page

A2001	Chief of Parties	44.16	11.43	12.64	1.15		L&M 0.10	69.48
--------------	------------------	-------	-------	-------	------	--	------------------------	-------

A2002	Party Chief	42.57	11.43	12.64	1.15		L&M 0.10	67.89
--------------	-------------	-------	-------	-------	------	--	------------------------	-------

A2003	Line & Grade Technician/Office Technician/GPS, Drones	41.97	11.43	12.64	1.15		L&M 0.10	67.29
--------------	---	-------	-------	-------	------	--	------------------------	-------

A2004	Associate Party Chief (including Instrument Person & Head Chain Person)/Stake Hop/Grademan	39.85	11.43	12.64	1.15		L&M 0.10	65.17
--------------	--	-------	-------	-------	------	--	------------------------	-------

A2006	Chain Person (for crews with more than 2 people)	35.51	11.43	12.64	1.15		L&M 0.10	60.83
--------------	--	-------	-------	-------	------	--	------------------------	-------

Truck Drivers

*See per diem note on last page

Wage benefits key: BHR=basic hourly rate; H&W=health and welfare; IAF=industry advancement fund; LEG=legal fund; L&M=labor/management fund; PEN=pension fund; SAF=safety; SUI=supplemental unemployment insurance; S&L=SUI & LEG combined; TRN=training; THR=total hourly rate; VAC=vacation

Truck Drivers

*See per diem note on last page

						L&M	
A2101	Group I, including:	40.94	11.43	12.64	1.15	0.10	66.26
	Air/Sea Traffic Controllers						
	Ambulance/Fire Truck Driver (EMT certified)						
	Boat Coxswain						
	Captains & Pilots (air & water)						
	Deltas, Commanders, Rollagons, & similar equipment (when pulling sleds, trailers or similar equipment)						
	Dump Trucks (including rockbuggy, side dump, belly dump, & trucks with pups) over 40 yards up to & including 60 yards						
	Helicopter Transporter						
	Liquid Vac Truck/Super Vac Truck						
	Material Coordinator or Purchasing Agent						
	Ready-mix (over 12 yards up to & including 15 yards) (over 15 yards to be negotiated)						
	Semi with Double Box Mixer						
	Tireman, Heavy Duty/Fueler						
	Water Wagon (250 Bbls and above)						
A2102	Group 1A including:	42.21	11.43	12.64	1.15	0.10	67.53
	Dump Trucks (including rockbuggy, side dump, belly dump & trucks with pups) over 60 yards up to & including 100 yards (over 100 yards to be negotiated)						
	Jeeps (driver under load)						
	Lowboys, including tractor attached trailers & jeeps, up to & including 12 axles (over 12 axles or 150 tons to be negotiated)						
A2103	Group II, including:	39.68	11.43	12.64	1.15	0.10	65.00
	All Deltas, Commanders, Rollagons, & similar equipment						
	Batch Trucks (8 yards & up)						
	Batch Trucks (up to & including 7 yards)						
	Boom Truck/Knuckle Truck (over 5 tons)						
	Cacasco Truck/Heat Stress Truck						
	Construction and Material Safety Technician						
	Dump Trucks (including rockbuggy, side dump, belly dump, & trucks with pups) over 20 yards up to & including 40 yards						
	Gin Pole Truck, Winch Truck, Wrecker (truck mounted "A" frame manufactured rating over 5 tons)						
	Mechanics						
	Oil Distributor Driver						
	Partsman						
	Ready-mix (up to & including 12 yards)						
	Stringing Truck						

Wage benefits key: BHR=basic hourly rate; H&W=health and welfare; IAF=industry advancement fund; LEG=legal fund; L&M=labor/management fund; PEN=pension fund; SAF=safety; SUI=supplemental unemployment insurance; S&L=SUI & LEG combined; TRN=training; THR=total hourly rate; VAC=vacation

Truck Drivers

*See per diem note on last page

A2103	Group II, including:	39.68	11.43	12.64	1.15		L&M 0.10	65.00
--------------	----------------------	-------	-------	-------	------	--	------------------------	-------

Turn-O-Wagon or DW-10 (not self loading)

A2104	Group III, including:	38.86	11.43	12.64	1.15		L&M 0.10	64.18
--------------	-----------------------	-------	-------	-------	------	--	------------------------	-------

- Boom Truck/Knuckle Truck (up to & including 5 tons)
- Dump Trucks (including rockbuggy, side dump, belly dump, & trucks with pups) over 10 yards up to & including 20 yards
- Expeditor (electrical & pipefitting materials)
- Gin Pole Truck, Winch Truck, Wrecker (truck mounted "A" frame manufactured rating 5 tons & under)
- Greaser - Shop
- Semi or Truck & Trailer
- Thermal Plastic Layout Technician
- Traffic Control Technician
- Trucks/Jeeps (push or pull)

A2105	Group IV, including:	38.28	11.43	12.64	1.15		L&M 0.10	63.60
--------------	----------------------	-------	-------	-------	------	--	------------------------	-------

- Air Cushion or similar type vehicle
- All Terrain Vehicle
- Buggymobile
- Bull Lift & Fork Lift, Fork Lift with Power Boom & Swing Attachment (over 5 tons)
- Bus Operator (over 30 passengers)
- Cement Spreader, Dry
- Combination Truck-Fuel & Grease
- Compactor (when pulled by rubber tired equipment)
- Dump Trucks (including rockbuggy, side dump, belly dump, & trucks with pups) up to & including 10 yards
- Dumpster
- Expeditor (general)
- Fire Truck/Ambulance Driver
- Flat Beds, Dual Rear Axle
- Foam Distributor Truck Dual Axle
- Front End Loader with Fork
- Grease Truck
- Hydro Seeder, Dual Axle
- Hyster Operators (handling bulk aggregate)
- Loadmaster (air & water operations)
- Lumber Carrier
- Ready-mix, (up to & including 7 yards)
- Rigger (air/water/oilfield)
- Tireman, Light Duty

Wage benefits key: BHR=basic hourly rate; H&W=health and welfare; IAF=industry advancement fund; LEG=legal fund; L&M=labor/management fund; PEN=pension fund; SAF=safety; SUI=supplemental unemployment insurance; S&L=SUI & LEG combined; TRN=training; THR=total hourly rate; VAC=vacation

Truck Drivers
 *See per diem note on last page

						L&M	
A2105	Group IV, including:	38.28	11.43	12.64	1.15	0.10	63.60
	Track Truck Equipment						
	Truck Vacuum Sweeper						
	Warehouseperson						
	Water Truck (Below 250 Bbls)						
	Water Truck (straight)						
	Water Wagon, Semi						

						L&M	
A2106	Group V, including:	37.52	11.43	12.64	1.15	0.10	62.84
	Buffer Truck						
	Bull Lifts & Fork Lifts, Fork Lifts with Power Boom & Swing Attachments (up to & including 5 tons)						
	Bus Operator (up to 30 passengers)						
	Farm Type Rubber Tired Tractor (when material handling or pulling wagons on a construction project)						
	Flat Beds, Single Rear Axle						
	Foam Distributor Truck Single Axle						
	Fuel Handler (station/bulk attendant)						
	Gear/Supply Truck						
	Gravel Spreader Box Operator on Truck						
	Hydro Seeders, Single axle						
	Pickups (pilot cars & all light-duty vehicles)						
	Rigger/Swamper						
	Tack Truck						
	Team Drivers (horses, mules, & similar equipment)						

Tunnel Workers, Laborers (The Alaska areas north of N63 latitude and east of W138 longitude)
 *See per diem note on last page

						L&M	LEG	
N2201	Group I, including:	34.88	8.95	17.81	1.30	0.20	0.20	63.34
	Brakeman							
	Mucker							
	Nipper							
	Storm Water Pollution Protection Plan Worker (SWPPP Worker - erosion and sediment control Laborer)							
	Topman & Bull Gang							
	Tunnel Track Laborer							

						L&M	LEG	
N2202	Group II, including:	35.98	8.95	17.81	1.30	0.20	0.20	64.44
	Burning & Cutting Torch							
	Certified Erosion Sediment Control Lead (CESCL Laborer)							

Wage benefits key: BHR=basic hourly rate; H&W=health and welfare; IAF=industry advancement fund; LEG=legal fund; L&M=labor/management fund; PEN=pension fund; SAF=safety; SUI=supplemental unemployment insurance; S&L=SUI & LEG combined; TRN=training; THR=total hourly rate; VAC=vacation

Tunnel Workers, Laborers (The Alaska areas north of N63 latitude and east of W138 longitude)
 *See per diem note on last page

N2202 Group II, including:	35.98	8.95	17.81	1.30		L&M	LEG	64.44
						0.20	0.20	

- Concrete Laborer
- Floor Preparation, Core Drilling
- Jackhammer/Chipping Gun or Pavement Breaker
- Laser Instrument Operator
- Nozzle men, Pumpcrete or Shotcrete
- Pipelayer Helper

N2203 Group III, including:	36.97	8.95	17.81	1.30		L&M	LEG	65.43
						0.20	0.20	

- Miner
- Retimberman

N2204 Group IIIA, including:	40.58	8.95	17.81	1.30		L&M	LEG	69.04
						0.20	0.20	

- Asphalt Raker, Asphalt Belly Dump Lay Down
- Drill Doctor (in the field)
- Driller (including, but not limited to wagon drills, air-track drills, hydraulic drills)
- Pioneer Drilling & Drilling Off Tugger (all type drills)
- Pipelayer
- Powderman (Employee Possessor)
- Storm Water Pollution Protection Plan Specialist (SWPPP Specialist)
- Traffic Control Supervisor, DOT Qualified

N2206 Group IIIB, including:	44.75	6.24	17.81	1.30		L&M	LEG	70.50
						0.20	0.20	

- Driller (including, but not limited to wagon drills, air-track drills, hydraulic drills)(over 5,000 hours)
- Federal Powderman (Responsible Person in Charge)
- Grade Checking (setting or transferring of grade marks, line and grade, GPS, drones)
- Pioneer Drilling & Drilling Off Tugger (all type drills)(over 5,000 hours)
- Stake Hopper

Tunnel Workers, Laborers (The area that is south of N63 latitude and west of W138 longitude)
 *See per diem note on last page

S2201 Group I, including:	34.88	8.95	17.81	1.30		L&M	LEG	63.34
						0.20	0.20	

- Brakeman
- Mucker
- Nipper
- Storm Water Pollution Protection Plan Worker (SWPPP Worker - erosion and sediment control Laborer)

Wage benefits key: BHR=basic hourly rate; H&W=health and welfare; IAF=industry advancement fund; LEG=legal fund; L&M=labor/management fund; PEN=pension fund; SAF=safety; SUI=supplemental unemployment insurance; S&L=SUI & LEG combined; TRN=training; THR=total hourly rate; VAC=vacation

Tunnel Workers, Laborers (The area that is south of N63 latitude and west of W138 longitude)
 *See per diem note on last page

S2201	Group I, including:	34.88	8.95	17.81	1.30		L&M	LEG	63.34
	Topman & Bull Gang								
	Tunnel Track Laborer								

S2202	Group II, including:	35.98	8.95	17.81	1.30		L&M	LEG	64.44
	Burning & Cutting Torch								
	Certified Erosion Sediment Control Lead (CESCL Laborer)								
	Concrete Laborer								
	Floor Preparation, Core Drilling								
	Jackhammer/Chipping Gun or Pavement Breaker								
	Laser Instrument Operator								
	Nozzlemen, Pumpcrete or Shotcrete								
	Pipelayer Helper								

S2203	Group III, including:	36.97	8.95	17.81	1.30		L&M	LEG	65.43
	Miner								
	Retimberman								

S2204	Group IIIA, including:	40.58	8.95	17.81	1.30		L&M	LEG	69.04
	Asphalt Raker, Asphalt Belly Dump Lay Down								
	Drill Doctor (in the field)								
	Driller (including, but not limited to wagon drills, air-track drills, hydraulic drills)								
	Pioneer Drilling & Drilling Off Tugger (all type drills)								
	Pipelayer								
	Powderman (Employee Possessor)								
	Storm Water Pollution Protection Plan Specialist (SWPPP Specialist)								
	Traffic Control Supervisor, DOT Qualified								

S2206	Group IIIB, including:	44.75	6.24	17.81	1.30		L&M	LEG	70.50
	Driller (including, but not limited to wagon drills, air-track drills, hydraulic drills)(over 5,000 hours)								
	Federal Powderman (Responsible Person in Charge)								
	Grade Checking (setting or transferring of grade marks, line and grade, GPS, drones)								
	Pioneer Drilling & Drilling Off Tugger (all type drills)(over 5,000 hours)								
	Stake Hopper								

Tunnel Workers, Power Equipment Operators
 *See per diem note on last page

Wage benefits key: BHR=basic hourly rate; H&W=health and welfare; IAF=industry advancement fund; LEG=legal fund; L&M=labor/management fund; PEN=pension fund; SAF=safety; SUI=supplemental unemployment insurance; S&L=SUI & LEG combined; TRN=training; THR=total hourly rate; VAC=vacation

Class Code	Classification of Laborers & Mechanics	BHR	H&W	PEN	TRN	Other	Benefits	THR
------------	--	-----	-----	-----	-----	-------	----------	-----

Tunnel Workers, Power Equipment Operators

*See per diem note on last page

A2207	Group I	45.68	10.35	13.00	1.00	L&M	0.10	0.05	70.18
A2208	Group IA	47.62	10.35	13.00	1.00	L&M	0.10	0.05	72.12
A2209	Group II	44.84	10.35	13.00	1.00	L&M	0.10	0.05	69.34
A2210	Group III	44.04	10.35	13.00	1.00	L&M	0.10	0.05	68.54
A2211	Group IV	37.21	10.35	13.00	1.00	L&M	0.10	0.05	61.71

* Per diem is an established practice for this classification. This means that per diem is an allowable alternative to board and lodging if all criteria are met. See 8 AAC 30.051-08 AAC 30.056, and the per diem information on page vii of this Pamphlet.

** Work in combination of classifications: Employees working in any combination of classifications within the diving crew (working diver, standby diver, and tender) in a shift are paid in the classification with the highest rate for a minimum of 8 hours per shift.

Wage benefits key: BHR=basic hourly rate; H&W=health and welfare; IAF=industry advancement fund; LEG=legal fund; L&M=labor/management fund; PEN=pension fund; SAF=safety; SUI=supplemental unemployment insurance; S&L=SUI & LEG combined; TRN=training; THR=total hourly rate; VAC=vacation

SECTION 011000 - SUMMARY

PART 1 - GENERAL

1.1 RELATED DOCUMENTS

- A. Drawings and general provisions of the Contract, including General and Supplementary Conditions and other Division 01 Specification Sections, apply to this Section.

1.2 SUMMARY

A. Section Includes:

1. Project information.
2. Work covered by Contract Documents.
3. Construction Period.
4. Access to site.
5. Coordination with occupants.
6. Work restrictions.
7. Specification and drawing conventions.
8. Miscellaneous Provisions.

B. Related Requirements:

1. Section 015000 "Temporary Facilities and Controls" for limitations and procedures governing temporary use of Owner's facilities.

1.3 PROJECT INFORMATION

- A. Project Identification: City & Borough of Juneau, Douglas Library, Meeting Room Renovation, BE20-259

1. Project Location:
 - a. 1016 3rd Street, Douglas, Alaska

- B. Owner: City and Borough of Juneau.

1. Owner's Representative;& CBJ Project Manager: Lisa EaganLagerquist, Project Manager 586-0893

- C. Architect/Engineer: Jensen Yorba Wall, Inc.

- D. Architect's Consultants: Architect has retained the following design professionals who have prepared designated portions of the Contract Documents:

1. Begenyi Engineering, Barry Begenyi

SECTION 011000 - SUMMARY

1.4 WORK COVERED BY CONTRACT DOCUMENTS

- A. The Work of Project is defined by the Contract Documents and consists of the following:
 - 1. Replace wood flooring with vinyl flooring and base; replace acoustical ceiling panels; patch and repair wall surfaces; paint walls; minor electrical work and patching, and other Work indicated in the Contract Documents.

- B. Type of Contract:
 - 1. Project will be constructed under a single prime contract.

1.5 ACCESS TO SITE

- A. General: Contractor shall have limited use of Project site for construction operations as indicated on Drawings by the Contract limits and as indicated by requirements of this Section.

- B. Use of Site: Limit use of premises to work areas and areas within the Contract limits indicated. Do not disturb portions of premises beyond areas in which the Work is indicated.
 - 1. Contractor Staging Area and construction area: Owner shall make **two parking spaces** below the library available for contractor parking or staging.

 - 2. Driveways, Walkways and Entrances: Keep driveways loading areas, and entrances serving premises clear and available to Users, Owner, Owner's employees and emergency vehicles at all times.
 - a. Schedule deliveries to minimize use of driveways and entrances by construction operations.
 - b. Schedule deliveries to minimize space and time requirements for storage of materials and equipment on-site.

 - 3. Owner Occupancy: Allow for limited Owner occupancy of the premises during construction.

The meeting room must be available for public use on August 17 & 18, 2020, for elections.

 - 4. Construction Debris: Construction debris shall be stored in dumpster or similar container when stored on the premises. During library operating hours the lobby must remain safe for the public. It's recommended that Construction Debris be removed during non-operational hours.

- C. Condition of Existing Building: Maintain portions of existing building affected by construction operations in a weather-tight condition throughout construction period. Repair damage caused by construction operations.

SECTION 011000 - SUMMARY

- D. Site Security: The Contractor shall be responsible for building security and protecting the site from theft, vandalism, and unauthorized entry during the construction period.

1.6 COORDINATION WITH OCCUPANTS

- A. Partial Owner Occupancy: Owner may occupy the portions of site and adjacent existing structures during the construction period, with the exception of areas under construction. Cooperate with Owner during construction operations to minimize conflicts and facilitate Owner usage. Perform the Work so as not to interfere with Owner's operations.

- 1. Provide not less than 72 hours' notice to Owner of activities that will affect Owner's operations.
- 2. Douglas Library hours of operation are:

Sunday	1-5 PM
Monday	2-8 PM
Tuesday	2-8 PM
Wednesday	2-8 PM
Thursday	11-5 PM
Friday	1-5 PM
Saturday	1-5 PM

Current COVID -19 Schedule library is only open Sunday – Wednesday.

1.7 WORK RESTRICTIONS

- A. Work Restrictions, General: Comply with limitations on use of public streets and with other requirements of authorities having jurisdiction.
- B. On-Site Work Hours: Limit work in the existing building to normal business working hours of 7:00 a.m. to 7:00 p.m., unless otherwise indicated.
- C. Existing Utility Interruptions: Do not interrupt utilities serving facilities occupied by Owner or others unless permitted under the following conditions and then only after providing temporary utility services according to requirements indicated:
 - 1. Notify Owner not less than 72 hours in advance of proposed utility interruptions.
 - 2. Obtain Owner's written permission before proceeding with utility interruptions.
- D. Noise, Vibration, and Odors: Coordinate operations that may result in high levels of noise and vibration, odors, or other disruption to Owner occupancy with Owner.
 - 1. Notify Owner not less than two days in advance of proposed disruptive operations.
 - 2. Obtain Owner's written permission before proceeding with disruptive operations.

SECTION 011000 - SUMMARY

- E. Controlled Substances: Use of tobacco products and controlled substances on Project site is not permitted.

1.8 SPECIFICATION AND DRAWING CONVENTIONS

- A. Specification Content: The Specifications use certain conventions for the style of language and the intended meaning of certain terms, words, and phrases when used in particular situations. These conventions are as follows:
 - 1. Imperative mood and streamlined language are generally used in the Specifications. The words "shall," "shall be," or "shall comply with," depending on the context, are implied where a colon (:) is used within a sentence or phrase.
 - 2. Specification requirements are to be performed by Contractor unless specifically stated otherwise.
- B. Division 01 General Requirements: Requirements of Sections in Division 01 apply to the Work of all Sections in the Specifications.
- C. Drawing Coordination: Requirements for materials and products identified on Drawings are described in detail in the Specifications. One or more of the following are used on Drawings to identify materials and products:
 - 1. Terminology: Materials and products are identified by the typical generic terms used in the individual Specifications Sections.

1.9 MISCELLANEOUS PROVISIONS

- A. All references in specifications to Engineer and Architect shall be facilitated and coordinated with the CBJ Project Manager.
- B. All references in the specifications to Owner or Owner's representative shall mean CBJ Project Manager.

END OF SECTION

SECTION 012300 - ALTERNATES

PART 1 - GENERAL

1.1 RELATED DOCUMENTS

- A. Drawings and general provisions of the Contract, including General and Supplementary Conditions and other Division 01 Specification Sections, apply to this Section.

1.2 SUMMARY

- A. Section includes administrative and procedural requirements for alternates.

1.3 DEFINITIONS

- A. Alternate: An amount proposed by bidders and stated on the Bid Form for certain work defined in the bidding requirements that may be added to deducted from the base bid amount if Owner decides to accept a corresponding change either in the amount of construction to be completed or in the products, materials, equipment, systems, or installation methods described in the Contract Documents.
 - 1. Alternates described in this Section are part of the Work only if enumerated in the Agreement.
 - 2. The cost or credit for each alternate is the net addition to or deduction from the Contract Sum to incorporate alternate into the Work. No other adjustments are made to the Contract Sum.

1.4 PROCEDURES

- A. All alternates will be Additive Alternates.
- B. Coordination: Revise or adjust affected adjacent work as necessary to completely integrate work of the alternate into Project.
 - 1. Include as part of each alternate, miscellaneous devices, accessory objects, and similar items incidental to or required for a complete installation whether or not indicated as part of alternate.
- C. Notification: Immediately following award of the Contract, notify each party involved, in writing, of the status of each alternate. Indicate if alternates have been accepted, rejected, or deferred for later consideration. Include a complete description of negotiated revisions to alternates.
- D. Execute accepted alternates under the same conditions as other work of the Contract.
- E. Schedule: A schedule of alternates is included at the end of this Section. Specification Sections referenced in schedule contain requirements for materials necessary to achieve the work described under each alternate.

SECTION 012300 - ALTERNATES

PART 2 - PRODUCTS (Not Used)

PART 3 - EXECUTION

3.1 SCHEDULE OF ADDITIVE ALTERNATES

- A. Alternate No. 1: Remove ceiling grid and dividing wall ceiling track. Provide ceiling grid.

END OF SECTION

SECTION 012500 - SUBSTITUTION PROCEDURES

PART 1 - GENERAL

1.1 RELATED DOCUMENTS

- A. Drawings and general provisions of the Contract, including General and Supplementary Conditions and other Division 01 Specification Sections, apply to this Section.

1.2 SUMMARY

- A. Section includes administrative and procedural requirements for substitutions.
- B. Related Requirements:
 - 1. Section 016000 "Product Requirements" for requirements for submitting comparable product submittals for products by listed manufacturers.

1.3 DEFINITIONS

- A. Substitutions: Changes in products, materials, equipment, and methods of construction from those required by the Contract Documents and proposed by Contractor.
 - 1. Substitutions for Cause: Changes proposed by Contractor that are required due to changed Project conditions, such as unavailability of product, regulatory changes, or unavailability of required warranty terms.
 - 2. Substitutions for Convenience: Changes proposed by Contractor or Owner that are not required in order to meet other Project requirements but may offer advantage to Contractor or Owner.

1.4 ACTION SUBMITTALS

- A. Substitution Requests: Submit electronic pdf file document of each request for consideration. Identify product or fabrication or installation method to be replaced. Include Specification Section number and title and Drawing numbers and titles.
 - 1. Substitution Request Form: Use CSI Form 13.1A or a similar form
 - 2. Documentation: Show compliance with requirements for substitutions and the following, as applicable:
 - a. Statement indicating why specified product or fabrication or installation cannot be provided.
 - b. Coordination information, including a list of changes or revisions needed to other parts of the Work and to construction performed by Owner and separate contractors that will be necessary to accommodate proposed substitution.

SECTION 012500 - SUBSTITUTION PROCEDURES

- c. Detailed comparison of significant qualities of proposed substitution with those of the Work specified. Include annotated copy of applicable Specification Section. Significant qualities may include attributes such as performance, weight, size, durability, visual effect, sustainable design characteristics, warranties, and specific features and requirements indicated. Indicate deviations, if any, from the Work specified.
 - d. Product Data, including drawings and descriptions of products and fabrication and installation procedures.
 - e. Samples, where applicable or requested.
 - f. Certificates and qualification data, where applicable or requested.
 - g. List of similar installations for completed projects with project names and addresses and names and addresses of architects and owners.
 - h. Material test reports from a qualified testing agency indicating and interpreting test results for compliance with requirements indicated.
 - i. Research reports evidencing compliance with building code in effect for Project, from ICC-ES.
 - j. Detailed comparison of Contractor's construction schedule using proposed substitution with products specified for the Work, including effect on the overall Contract Time. If specified product or method of construction cannot be provided within the Contract Time, include letter from manufacturer, on manufacturer's letterhead, stating date of receipt of purchase order, lack of availability, or delays in delivery.
 - k. Cost information, including a proposal of change, if any, in the Contract Sum.
 - l. Contractor's certification that proposed substitution complies with requirements in the Contract Documents except as indicated in substitution request, is compatible with related materials, and is appropriate for applications indicated.
 - m. Contractor's waiver of rights to additional payment or time that may subsequently become necessary because of failure of proposed substitution to produce indicated results.
3. Architect's Action: If necessary, Architect will request additional information or documentation for evaluation within seven days of receipt of a request for substitution. Architect will notify Contractor of acceptance or rejection of proposed substitution within 7 days of receipt of request, or seven days of receipt of additional information or documentation, whichever is later.
 - a. Forms of Acceptance: Change Order, Construction Change Directive, or Architect's Supplemental Instructions for minor changes in the Work.
 - b. Use product specified if Architect does not issue a decision on use of a proposed substitution within time allocated.

1.5 QUALITY ASSURANCE

- A. Compatibility of Substitutions: Investigate and document compatibility of proposed substitution with related products and materials. Engage a qualified testing agency to perform compatibility tests recommended by manufacturers.

SECTION 012500 - SUBSTITUTION PROCEDURES

1.6 PROCEDURES

- A. Coordination: Revise or adjust affected work as necessary to integrate work of the approved substitutions.

PART 2 - PRODUCTS

2.1 SUBSTITUTIONS

- A. Substitutions for Cause: Submit requests for substitution immediately on discovery of need for change, but not later than 15 days prior to time required for preparation and review of related submittals.

- 1. Conditions: Architect will consider Contractor's request for substitution when the following conditions are satisfied. If the following conditions are not satisfied, Architect will return requests without action, except to record noncompliance with these requirements:

- a. Requested substitution is consistent with the Contract Documents and will produce indicated results.
- b. Substitution request is fully documented and properly submitted.
- c. Requested substitution will not adversely affect Contractor's construction schedule.
- d. Requested substitution has received necessary approvals of authorities having jurisdiction.
- e. Requested substitution is compatible with other portions of the Work.
- f. Requested substitution has been coordinated with other portions of the Work.
- g. Requested substitution provides specified warranty.
- h. If requested substitution involves more than one contractor, requested substitution has been coordinated with other portions of the Work, is uniform and consistent, is compatible with other products, and is acceptable to all contractors involved.

- B. Substitutions for Convenience: Architect will consider requests for substitution if received within 30 days after the Notice to Proceed. Requests received after that time will not be considered.

- 1. Conditions: Architect will consider Contractor's request for substitution when the following conditions are satisfied. If the following conditions are not satisfied, Architect will return requests without action, except to record noncompliance with these requirements:

- a. Requested substitution offers Owner a substantial advantage in cost, time, energy conservation, or other considerations, after deducting additional responsibilities Owner must assume. Owner's additional responsibilities may include compensation to Architect for redesign and evaluation services, increased cost of other construction by Owner, and similar considerations.
- b. Requested substitution does not require extensive revisions to the Contract Documents.
- c. Requested substitution is consistent with the Contract Documents and will produce indicated results.

SECTION 012500 - SUBSTITUTION PROCEDURES

- d. Substitution request is fully documented and properly submitted.
- e. Requested substitution will not adversely affect Contractor's construction schedule.
- f. Requested substitution has received necessary approvals of authorities having jurisdiction.
- g. Requested substitution is compatible with other portions of the Work.
- h. Requested substitution has been coordinated with other portions of the Work.
- i. Requested substitution provides specified warranty.
- j. If requested substitution involves more than one contractor, requested substitution has been coordinated with other portions of the Work, is uniform and consistent, is compatible with other products, and is acceptable to all contractors involved.

PART 3 - EXECUTION (Not Used)

END OF SECTION

SECTION 012600 - CONTRACT MODIFICATION PROCEDURES

PART 1 - GENERAL

1.1 RELATED DOCUMENTS

- A. Drawings and general provisions of the Contract, including General and Supplementary Conditions and other Division 01 Specification Sections, apply to this Section.

1.2 SUMMARY

- A. Section includes administrative and procedural requirements for handling and processing Contract modifications.
- B. Related Requirements:
 - 1. Section 012500 "Substitution Procedures" for administrative procedures for handling requests for substitutions made after the Contract award.
- C. Contractor fees shall not exceed fees defined in Section 00700 General Conditions, Article 11.4 Contractor Fees. This includes all WORK CHANGE PROPOSAL REQUESTS.

1.3 PROPOSAL REQUESTS

- A. Owner-Initiated Proposal Requests: Owner's Representative will issue a detailed description of proposed changes in the Work that may require adjustment to the Contract Sum or the Contract Time. If necessary, the description will include supplemental or revised Drawings and Specifications.
 - 1. Work Change Proposal Requests issued, are not instructions either to stop work in progress or to execute the proposed change.
 - 2. Within time specified in Proposal Request or 10 days, when not otherwise specified, after receipt of Proposal Request, submit a quotation estimating cost adjustments to the Contract Sum and the Contract Time necessary to execute the change.
 - a. Include a list of quantities of products required or eliminated and unit costs, with total amount of purchases and credits to be made. If requested, furnish survey data to substantiate quantities.
 - b. Indicate applicable taxes, delivery charges, equipment rental, and amounts of trade discounts.
 - c. Include costs of labor and supervision directly attributable to the change.
 - d. Include an updated Contractor's construction schedule that indicates the effect of the change, including, but not limited to, changes in activity duration, start and finish times, and activity relationship. Use available total float before requesting an extension of the Contract Time.
 - e. Quotation Form: Use forms acceptable to Architect.
- B. Contractor-Initiated Proposals: If latent or changed conditions require modifications to the Contract, Contractor may initiate a claim by submitting a request for a change to Owner's Representative.

SECTION 012600 - CONTRACT MODIFICATION PROCEDURES

1. Include a statement outlining reasons for the change and the effect of the change on the Work. Provide a complete description of the proposed change. Indicate the effect of the proposed change on the Contract Sum and the Contract Time.
2. Include a list of quantities of products required or eliminated and unit costs, with total amount of purchases and credits to be made. If requested, furnish survey data to substantiate quantities.
3. Indicate applicable taxes, delivery charges, equipment rental, and amounts of trade discounts.
4. Include costs of labor and supervision directly attributable to the change.
5. Include an updated Contractor's construction schedule that indicates the effect of the change, including, but not limited to, changes in activity duration, start and finish times, and activity relationship. Use available total float before requesting an extension of the Contract Time.
6. Comply with requirements in Section 012500 "Substitution Procedures" if the proposed change requires substitution of one product or system for product or system specified.
7. Proposal Request Form: Use form acceptable to Architect.

1.4 CHANGE ORDER PROCEDURES

- A. On Owner's approval of a Work Changes Proposal Request, Owner's Representative will issue a Change Order for signatures of Owner and Contractor.
- B. Owner will group approved Work Changes into a formal Change Order every three months for formal inclusion into the Construction Agreement.

1.5 CONSTRUCTION CHANGE DIRECTIVE

- A. Construction Change Directive: Owner's Representative may issue a Construction Change Directive on AIA Document G714 or a similar form. Construction Change Directive instructs Contractor to proceed with a change in the Work when there is not time for a Work Change Proposal request or a lump sum cannot be agreed on, for subsequent inclusion in a Change Order.
 1. Construction Change Directive contains a complete description of change in the Work. It also designates method to be followed to determine change in the Contract Sum or the Contract Time.
- B. Documentation: Maintain detailed records on a time and material basis of work required by the Construction Change Directive.
 1. After completion of change, submit an itemized account and supporting data necessary to substantiate cost and time adjustments to the Contract.

PART 2 - PRODUCTS (Not Used)

PART 3 - EXECUTION (Not Used)

END OF SECTION

SECTION 012900 – PAYMENT PROCEDURES

PART 1 - GENERAL

1.1 RELATED DLOCUMENTS

- A. Drawings and general provisions of the Contract, including General and Supplementary Conditions and other Division 01 Specification Sections, apply to this Section.

1.2 SUMMAY

- A. Section includes administrative provisions for submitting Schedule of Values and Pay Applications
- B. Related Requirements:
 - 1. Section 013100 "Project Management and Coordination" for requirements for submitting Pay Applications.
 - 2. Section 017700 "Closeout Procedures" for requirements for submitting final Pay Application.

1.3 SCHEDULE OF VALUES

- A. Coordination: Coordinate preparation of the schedule of values with preparation of Contractor's construction schedule.
 - 1. Coordinate line items in the schedule of values with other required administrative forms and schedules, including the following:
 - a. Application for Payment forms with continuation sheets.
 - b. Submittal schedule.
 - c. Items required to be indicated as separate activities in Contractor's construction schedule.
 - 2. Submit the schedule of values to Architect at earliest possible date, but no later than 14 days before the date scheduled for submittal of initial Applications for Payment.
- B. Format and Content: Use Project Manual table of contents as a guide to establish line items for the schedule of values. Provide at least one line item for each Specification Section.
 - 1. Identification: Include the following Project identification on the schedule of values:
 - a. Project name and location.
 - b. Name of Architect.
 - c. Architect's project number.
 - d. Contractor's name and address.
 - e. Date of submittal.

SECTION 012900 – PAYMENT PROCEDURES

2. Arrange the schedule of values in tabular form with separate columns to indicate the following for each item listed:
 - a. Related Specification Section or Division.
 - b. Description of the Work.
 - c. Name of subcontractor, manufacturer, fabricator, or supplier.
 - d. Change Orders (numbers) that affect value.
 - e. Dollar value of the following, as a percentage of the Contract Sum to nearest one-hundredth percent, adjusted to total 100 percent.
 - 1) Labor.
 - 2) Materials.
 - 3) Equipment.
 - 4) Work completed from previous application
 - 5) Work completed, This Period
 - 6) Materials presently stored
 - 7) Percent completed
 - 8) Balance to finish
 3. Provide a breakdown of the Contract Sum in enough detail to facilitate continued evaluation of Applications for Payment and progress reports. Coordinate with Project Manual table of contents.
 4. Round amounts to nearest whole dollar; total shall equal the Contract Sum.
 5. Provide a separate line item in the schedule of values for each part of the Work where Applications for Payment may include materials or equipment purchased or fabricated and stored, but not yet installed.
 - a. Differentiate between items stored on-site and items stored off-site. If required, include evidence of insurance.
 6. Each item in the schedule of values and Applications for Payment shall be complete. Include total cost and proportionate share of general overhead and profit for each item.
 - a. Temporary facilities and other major cost items that are not direct cost of actual work-in-place may be shown either as separate line items in the schedule of values or distributed as general overhead expense, at Contractor's option.
 7. Schedule Updating: Update and resubmit the schedule of values before the next Applications for Payment when Change Orders or Construction Change Directives result in a change in the Contract Sum.
- C. Final Payment – Submit final Application for Payment in conjunction with other closeout documentation as noted in SECTION 017700 “Closeout Procedures”. Final payment shall be for no less than 5% of the contract total and will be released when all closeout documentation and actions are complete.

SECTION 012900 – PAYMENT PROCEDURES

1.4 APPLICATION AND CERTIFICATION FOR PAYMENT

- A. Format and Content: Use AIA G702 Application and Certificate for Payment or equal.

PART 2 – PRODUCTS (Not Used)

PART 3 – EXECUTION (Not Used)

END OF SECTION

SECTION 013100 - PROJECT MANAGEMENT AND COORDINATION

PART 1 - GENERAL

1.1 RELATED DOCUMENTS

- A. Drawings and general provisions of the Contract, including General and Supplementary Conditions and other Division 01 Specification Sections, apply to this Section.

1.2 SUMMARY

- A. Section includes administrative provisions for coordinating construction operations on Project including, but not limited to, the following:
 - 1. General coordination procedures.
 - 2. Coordination drawings.
 - 3. Requests for Information (RFIs).
 - 4. Design clarifications (DC's)
 - 5. Project meetings.
- B. Each contractor shall participate in coordination requirements. Certain areas of responsibility are assigned to a specific contractor.
- C. Related Requirements:
 - 1. Section 013200 "Construction Progress Documentation" for preparing and submitting Contractor's construction schedule.
 - 2. Section 017300 "Execution" for procedures for coordinating general installation and field-engineering services, including establishment of benchmarks and control points.
 - 3. Section 017700 "Closeout Procedures" for coordinating closeout of the Contract.

1.3 DEFINITIONS

- A. RFI: Request from Owner, Architect, or Contractor seeking information required by or clarifications of the Contract Documents.
- B. DC: Document issued by Design team providing clarification of design intent or interpretation of the Contract Documents.

1.4 INFORMATIONAL SUBMITTALS

- A. Subcontract List: Within 15 day of Notice To Proceed, submit a written summary identifying individuals or firms proposed for each portion of the Work, including those who are to furnish products or equipment fabricated to a special design. Include the following information in tabular form:
 - 1. Name, address, and telephone number of entity performing subcontract or supplying products.

SECTION 013100 - PROJECT MANAGEMENT AND COORDINATION

2. Number and title of related Specification Section(s) covered by subcontract.
- B. Key Personnel Names: Within 15 days of Notice To Proceed, submit a list of key personnel assignments, including superintendent and other personnel in attendance at Project site. Identify individuals and their duties and responsibilities; list addresses and telephone numbers, including office and cellular telephone numbers and e-mail addresses. Provide names, addresses, and telephone numbers of individuals assigned as alternates in the absence of individuals assigned to Project.
1. Post copies of list in project meeting room, in temporary field office, and by each temporary telephone once on site work commences. Keep list current at all times.

1.5 GENERAL COORDINATION PROCEDURES

- A. Coordination: Coordinate construction operations included in different Sections of the Specifications to ensure efficient and orderly installation of each part of the Work. Coordinate construction operations, included in different Sections that depend on each other for proper installation, connection, and operation.
1. Schedule construction operations in sequence required to obtain the best results where installation of one part of the Work depends on installation of other components, before or after its own installation.
 2. Coordinate installation of different components to ensure maximum performance and accessibility for required maintenance, service, and repair.
 3. Make adequate provisions to accommodate items scheduled for later installation.
- B. Prepare memoranda for distribution to each party involved, outlining special procedures required for coordination. Include such items as required notices, reports, and list of attendees at meetings.
1. Prepare similar memoranda for Owner and separate contractors if coordination of their Work is required.
- C. Administrative Procedures: Coordinate scheduling and timing of required administrative procedures with other construction activities to avoid conflicts and to ensure orderly progress of the Work. Such administrative activities include, but are not limited to, the following:
1. Preparation of Contractor's construction schedule.
 2. Preparation of the schedule of values.
 3. Installation and removal of temporary facilities and controls.
 4. Delivery and processing of submittals.
 5. Progress meetings.
 6. Preinstallation conferences.
 7. Project closeout activities.
 8. Startup and adjustment of systems.
- D. Salvage materials and equipment involved in performance of, but not actually incorporated into, the Work. See other Sections for disposition of salvaged materials that are designated as Owner's property.

SECTION 013100 - PROJECT MANAGEMENT AND COORDINATION

1.6 REQUESTS FOR INFORMATION (RFIs)

- A. General: Immediately on discovery of the need for additional information or interpretation of the Contract Documents, Contractor shall prepare and submit an RFI in the form specified.
1. Architect will return RFIs submitted to Architect by other entities controlled by Contractor with no response.
 2. Coordinate and submit RFIs in a prompt manner so as to avoid delays in Contractor's work or work of subcontractors.
- B. Content of the RFI: Include a detailed, legible description of item needing information or interpretation and the following:
1. Project name.
 2. Project number.
 3. Date.
 4. Name of Contractor.
 5. Name of Architect.
 6. RFI number, numbered sequentially.
 7. RFI subject.
 8. Specification Section number and title and related paragraphs, as appropriate.
 9. Drawing number and detail references, as appropriate.
 10. Field dimensions and conditions, as appropriate.
 11. Contractor's suggested resolution. If Contractor's suggested resolution impacts the Contract Time or the Contract Sum, Contractor shall state impact in the RFI.
 12. Contractor's signature.
 13. Attachments: Include sketches, descriptions, measurements, photos, Product Data, Shop Drawings, coordination drawings, and other information necessary to fully describe items needing interpretation.
 - a. Include dimensions, thicknesses, structural grid references, and details of affected materials, assemblies, and attachments on attached sketches.
- C. RFI Forms: AIA Document G716 or other approved form.
1. Form and Attachments shall be electronic files in Adobe Acrobat PDF format.
- D. Architect's Action: Architect will review each RFI, determine action required, and respond. Allow seven working days for Architect's response for each RFI.
1. The following Contractor-generated RFIs will be returned without action:
 - a. Requests for approval of submittals.
 - b. Requests for approval of substitutions.
 - c. Requests for approval of Contractor's means and methods.
 - d. Requests for coordination information already indicated in the Contract Documents.
 - e. Requests for adjustments in the Contract Time or the Contract Sum.
 - f. Requests for interpretation of Architect's actions on submittals.
 - g. Incomplete RFIs or inaccurately prepared RFIs.

SECTION 013100 - PROJECT MANAGEMENT AND COORDINATION

2. Architect's action may include a request for additional information, in which case Architect's time for response will date from time of receipt of additional information.
 3. Architect's action on RFIs that may result in a change to the Contract Time or the Contract Sum may be eligible for Contractor to submit Change Proposal according to Section 012600 "Contract Modification Procedures."
 - a. If Contractor believes the RFI response warrants change in the Contract Time or the Contract Sum, notify Architect in writing within 5 days of receipt of the RFI response.
- E. RFI Log: Prepare, maintain, and submit a tabular log of RFIs organized by the RFI number. Submit log weekly. Include the following:
1. Project name.
 2. RFI number including RFIs that were returned without action or withdrawn.
 3. RFI description.
 4. Date the RFI was submitted.
 5. Date Architect's response was received.
- F. On receipt of Architect's action, update the RFI log and immediately distribute the RFI response to affected parties. Review response and notify Architect within 5 days if Contractor disagrees with response.
- 1.7 DESIGN CLARIFICATIONS (DCs)
- A. On receipt of Design Clarification immediately distribute the DC to affected parties.
1. Architect's action on DCs that may result in a change to the Contract Time or the Contract Sum may be eligible for Contractor to submit Proposal Request according to Section 012600 "Contract Modification Procedures."
 - a. If Contractor believes the DC warrants change in the Contract Time or the Contract Sum, notify Architect in writing within 7 days of receipt of the DC.
- 1.8 PROJECT MEETINGS
- A. General: Owner's representative to schedule and conduct meetings and conferences at Project site unless otherwise indicated.
1. Attendees: Inform participants and others involved, and individuals whose presence is required, of date and time of each meeting.
 2. Agenda: Owner's representative to prepare the meeting agenda. Distribute the agenda to all invited attendees.
 3. Minutes: Entity responsible for conducting meeting will record and distribute meeting minutes.
- B. Preconstruction Conference: Owner's Representative will schedule and conduct a preconstruction conference before starting construction, at a time convenient to Owner and Architect, but no later than 15 days of Notice to Proceed.

SECTION 013100 - PROJECT MANAGEMENT AND COORDINATION

1. Conduct the conference to review responsibilities and personnel assignments.
 2. Attendees: Authorized representatives of Owner Architect, and their consultants; Contractor and its superintendent; major subcontractors; suppliers; and other concerned parties shall attend the conference. Participants at the conference shall be familiar with Project and authorized to conclude matters relating to the Work.
 3. Agenda: Discuss items of significance that could affect progress, including the following:
 - a. Designation of key personnel and their duties.
 - b. Lines of communications.
 - c. Tentative construction schedule.
 - d. Critical work sequencing and long-lead items.
 - e. Distribution of the Contract Documents.
 - f. Procedures for processing field decisions, Proposal Requests, and Change Orders and Construction Change Directives. (Include discussion on Overhead: GC 11.4 & 012600 1.2 C)
 - g. Procedures for RFIs & DC's.
 - h. Procedures for testing and inspecting.
 - i. Procedures for processing Applications for Payment.
 - j. Procedure for submitting Certified Payroll
 - k. Procedures for submitting Daily Construction reports
 - l. Submittal procedures.
 - m. Use of the premises and existing building.
 - n. Work restrictions.
 - o. Working hours.
 - p. Owner's occupancy requirements.
 - q. Responsibility for temporary facilities and controls.
 - r. Procedures for disruptions and shutdowns.
 - s. Construction waste management and recycling.
 - t. Parking availability.
 - u. Office, work, and storage areas.
 - v. Equipment deliveries and priorities.
 - w. First aid.
 - x. Security.
 - y. Progress cleaning.
 - z. Progress meetings
- C. Pre-installation Conferences: Contractor shall conduct a pre-installation conference at Project site before each construction activity that requires coordination with other construction.
1. Attendees: Installer and representatives of manufacturers and fabricators involved in or affected by the installation and its coordination or integration with other materials and installations that have preceded or will follow, shall attend the meeting. Advise Owner's Representative, Architect, and Owner's Commissioning Authority of scheduled meeting dates.
 2. Agenda: Review progress of other construction activities and preparations for the particular activity under consideration, including requirements for the following:
 - a. Contract Documents.
 - b. Options.

SECTION 013100 - PROJECT MANAGEMENT AND COORDINATION

- c. Related RFIs & DC's.
 - d. Related Change Orders.
 - e. Submittals.
 - f. Possible conflicts.
 - g. Compatibility requirements.
 - h. Manufacturer's written instructions.
 - i. Warranty requirements.
 - j. Compatibility of materials.
 - k. Acceptability of substrates.
 - l. Temporary facilities and controls.
 - m. Space and access limitations.
 - n. Regulations of authorities having jurisdiction.
 - o. Installation procedures.
 - p. Coordination with other work.
 - q. Protection of adjacent work.
3. Record significant conference discussions, agreements, and disagreements, including required corrective measures and actions.
 4. Do not proceed with installation if the conference cannot be successfully concluded. Initiate whatever actions are necessary to resolve impediments to performance of the Work and reconvene the conference at earliest feasible date.
- D. Progress Meetings: Owner's representative to conduct progress meetings at weekly intervals.
1. Attendees: In addition to representatives of Owner and Architect, each contractor, subcontractor, supplier, and other entity concerned with current progress or involved in planning, coordination, or performance of future activities shall be represented at these meetings. All participants at the meeting shall be familiar with Project and authorized to conclude matters relating to the Work.
 2. Agenda: Review and correct or approve minutes of previous progress meeting. Review other items of significance that could affect progress. Include topics for discussion as appropriate to status of Project.
 - a. Contractor's Construction Schedule: Review progress since the last meeting. Determine whether each activity is on time, ahead of schedule, or behind schedule, in relation to Contractor's construction schedule. Determine how construction behind schedule will be expedited; secure commitments from parties involved to do so. Discuss whether schedule revisions are required to ensure that current and subsequent activities will be completed within the Contract Time.
 - 1) Review schedule for next period.
 - 2) Review off site fabrication/materials & lead times.
 - b. Review present and future needs of each entity present, including the following:
 - 1) Sequence of operations.
 - 2) Coordination with owner.
 - 3) Status of submittals.
 - 4) Status of correction of deficient items.
 - 5) Field observations.
 - 6) Status of RFIs & DC's.

SECTION 013100 - PROJECT MANAGEMENT AND COORDINATION

- 7) Status of proposal requests.
 - 8) Pending changes.
 - 9) Status of Change Orders.
 - 10) Pending claims and disputes.
 - 11) Status of record drawings.
 - 12) Documentation of information for payment requests.
- c. Schedule Updating: Contractor shall revise construction schedule after each progress meeting where revisions to the schedule have been made or recognized. Issue revised schedule prior to next meeting.

PART 2 - PRODUCTS (Not Used)

PART 3 - EXECUTION (Not Used)

END OF SECTION

SECTION 013200 - CONSTRUCTION PROGRESS DOCUMENTATION

PART 1 - GENERAL

1.1 RELATED DOCUMENTS

- A. Drawings and general provisions of the Contract, including General and Supplementary Conditions and other Division 01 Specification Sections, apply to this Section.

1.2 SUMMARY

- A. Section includes administrative and procedural requirements for documenting the progress of construction during performance of the Work, including the following:
 - 1. Contractor's construction schedule.
 - 2. Construction schedule updating reports.
 - 3. Daily construction reports.
 - 4. Site condition reports.
 - 5. Special reports.
- B. Related Requirements:
 - 1. Section 013300 "Submittal Procedures" for submitting schedules and reports.
 - 2. Section 014000 "Quality Requirements" for submitting a schedule of tests and inspections.

1.3 DEFINITIONS

- A. Activity: A discrete part of a project that can be identified for planning, scheduling, monitoring, and controlling the construction project. Activities included in a construction schedule consume time and resources.
 - 1. Critical Activity: An activity on the critical path that must start and finish on the planned early start and finish times.
 - 2. Predecessor Activity: An activity that precedes another activity in the network.
 - 3. Successor Activity: An activity that follows another activity in the network.
- B. CPM: Critical path method, which is a method of planning and scheduling a construction project where activities are arranged based on activity relationships. Network calculations determine when activities can be performed and the critical path of Project.
- C. Critical Path: The longest connected chain of interdependent activities through the network schedule that establishes the minimum overall Project duration and contains no float.
- D. Event: The starting or ending point of an activity.
- E. Float: The measure of leeway in starting and completing an activity.

SECTION 013200 - CONSTRUCTION PROGRESS DOCUMENTATION

1. Float time is not for the exclusive use or benefit of either Owner or Contractor, but is a jointly owned, expiring Project resource available to both parties as needed to meet schedule milestones and Contract completion date.
2. Free float is the amount of time an activity can be delayed without adversely affecting the early start of the successor activity.
3. Total float is the measure of leeway in starting or completing an activity without adversely affecting the planned Project completion date.

1.4 INFORMATIONAL SUBMITTALS

- A. Format for Submittals: Submit required submittals in the following format:
 1. Working electronic copy of schedule file, where indicated.
 2. PDF electronic file.
- B. Contractor's Construction Schedule: Initial schedule, of size required to display entire schedule for entire construction period.
- C. Construction Schedule Updating Reports: Submit with Applications for Payment.
- D. Daily Construction Reports: Submit at daily or weekly intervals.
- E. Site Condition Reports: Submit at time of discovery of differing conditions.
- F. Special Reports: Submit at time of unusual event.

PART 2 - PRODUCTS

2.1 CONTRACTOR'S CONSTRUCTION SCHEDULE, GENERAL

- A. CPM Schedule: Prepare and submit Contractor's construction schedule no later than 15 days after date established for the Notice to Proceed.
 1. Activities: Indicate the estimated time duration, sequence requirements, and relationship of each activity in relation to other activities.
 2. Critical Path Activities: Identify critical path activities; scheduled start and completion dates shall be consistent with Contract milestone dates.
- B. Contract Modifications: For each proposed contract modification and concurrent with its submission, prepare a time-impact analysis using a network fragment to demonstrate the effect of the proposed change on the overall project schedule.
- C. Time Frame: Extend schedule from date established for the Notice to Proceed to date of Substantial Completion and Final completion of project.
 1. Contract completion date shall not be changed by submission of a schedule that shows an early completion date, unless specifically authorized by Change Order.

SECTION 013200 - CONSTRUCTION PROGRESS DOCUMENTATION

- D. Activities: At a minimum, provide a separate numbered activity for each specification section and main element of the Work. Comply with the following:
1. Activity Duration: Define activities so no activity is longer than 10 days, unless specifically allowed by Architect.
 2. Activity Grouping: Group activities by separate project areas to provide a standalone schedule for each project area. Coordinate activities between project areas.
 3. Submittal Activities: Include submittal process activities.
 4. Procurement Activities: Include procurement process activities for the following long lead items and major items requiring a cycle of more than 60 days, as separate activities in schedule. Procurement cycle activities include, but are not limited to, submittals, approvals, purchasing, fabrication, and delivery.
 5. Startup and Testing Time: Include no fewer than 5 days for startup and testing.
 6. Substantial Completion: Indicate completion in advance of date established for Substantial Completion, and allow time for Architect's administrative procedures necessary for certification of Substantial Completion.
 7. Punch List and Final Completion: Include not more than 10 days for completion of punch list items and final completion.
- E. Constraints: Include constraints and work restrictions indicated in the Contract Documents and as follows in schedule, and show how the sequence of the Work is affected.
1. Construction Areas: Identify each major area of construction for each major portion or phase of the Work.
- F. Milestones: Include milestones indicated in the Contract Documents in schedule, including, but not limited to, the Notice to Proceed, Substantial Completion, and final completion for each project area and dates of building occupancy.
- G. Recovery Schedule: When periodic update indicates the Work is 7 or more calendar days behind the current approved schedule, submit a separate recovery schedule indicating means by which Contractor intends to regain compliance with the schedule. Indicate changes to working hours, working days, crew sizes, and equipment required to achieve compliance, and date by which recovery will be accomplished.
- H. Computer Scheduling Software: Prepare schedules using current version of a program that has been developed specifically to manage construction schedules.

2.2 REPORTS

- A. Daily Construction Reports: Prepare a daily construction report recording the following information concerning events at Project site:
1. List of subcontractors at Project site.
 2. List of separate contractors at Project site.
 3. Approximate count of personnel at Project site.
 4. Equipment at Project site.
 5. Material deliveries.

SECTION 013200 - CONSTRUCTION PROGRESS DOCUMENTATION

6. High and low temperatures and general weather conditions, including presence of rain or snow.
 7. Accidents.
 8. Stoppages, delays, shortages, and losses.
 9. Emergency procedures.
 10. Orders and requests of authorities having jurisdiction.
 11. Services connected and disconnected.
 12. Equipment or system tests and startups.
- B. Site Condition Reports: Immediately on discovery of a difference between site conditions and the Contract Documents, prepare and submit a detailed report. Submit with a Request for Information. Include a detailed description of the differing conditions, together with recommendations for changing the Contract Documents.

2.3 SPECIAL REPORTS

- A. General: Submit special reports directly to Owner within one day of an occurrence. Distribute copies of report to parties affected by the occurrence.
- B. Reporting Unusual Events: When an event of an unusual and significant nature occurs at Project site, whether or not related directly to the Work, prepare and submit a special report.

PART 3 - EXECUTION

3.1 CONTRACTOR'S CONSTRUCTION SCHEDULE

- A. Contractor's Construction Schedule Updating: At weekly intervals, update schedule to reflect actual construction progress and activities. Issue schedule two days before each regularly scheduled weekly progress meeting.
- B. Distribution: Distribute copies of approved schedule to Architect, Owner, separate contractors, testing and inspecting agencies, and other parties identified by Contractor with a need-to-know schedule responsibility.

END OF SECTION

SECTION 013300 - SUBMITTAL PROCEDURES

PART 1 - GENERAL

1.1 RELATED DOCUMENTS

- A. Drawings and general provisions of the Contract, including General and Supplementary Conditions and other Division 01 Specification Sections, apply to this Section.

1.2 SUMMARY

- A. Section includes requirements for the submittal schedule and administrative and procedural requirements for submitting Shop Drawings, Product Data, Samples, and other submittals.
- B. Related Requirements:
 - 1. Section 013200 "Construction Progress Documentation" for submitting schedules and reports, including Contractor's construction schedule.
 - 2. Section 017823 "Operation and Maintenance Data" for submitting operation and maintenance manuals.
 - 3. Section 017839 "Project Record Documents" for submitting record Drawings, record Specifications, and record Product Data.

1.3 DEFINITIONS

- A. Action Submittals: Written and graphic information and physical samples that require Architect's responsive action. Action submittals are those submittals indicated in individual Specification Sections as "action submittals."
- B. Informational Submittals: Written and graphic information and physical samples that do not require Architect's responsive action. Submittals may be rejected for not complying with requirements. Informational submittals are those submittals indicated in individual Specification Sections as "informational submittals."
- C. File Transfer Protocol (FTP): Communications protocol that enables transfer of files to and from another computer over a network and that serves as the basis for standard Internet protocols. An FTP site is a portion of a network located outside of network firewalls within which internal and external users are able to access files.
- D. Portable Document Format (PDF): An open standard file format licensed by Adobe Systems used for representing documents in a device-independent and display resolution-independent fixed-layout document format.

1.4 SUBMITTAL ADMINISTRATIVE REQUIREMENTS

- A. Architect's Digital Data Files: Electronic digital data files of the Contract Drawings will be provided by Owner for Contractor's use in preparing submittals.

SECTION 013300 - SUBMITTAL PROCEDURES

1. Owner will furnish Contractor one set of digital data drawing files of the Contract Drawings for use in preparing Shop Drawings.
 - a. Architect makes no representations as to the accuracy or completeness of digital data drawing files as they relate to the Contract Drawings.
- B. Coordination: Coordinate preparation and processing of submittals with performance of construction activities. Architect reserves the right to withhold action on a submittal requiring coordination with other submittals until related submittals are received.
- C. Processing Time: Allow time for submittal review, including time for resubmittals, as follows: 15 days for each review. Time for review shall commence on Architect's receipt of submittal. No extension of the Contract Time will be authorized because of failure to transmit submittals enough in advance of the Work to permit processing, including resubmittals.
- D. All submittals to be submitted electronically with the exception of physical samples.
- E. Paper Submittals (Where electronic submittal is impossible or owner request a paper submittal): Place a permanent label or title block on each submittal item for identification.
 1. Indicate name of firm or entity that prepared each submittal on label or title block.
 2. Provide a space approximately 6 by 8 inches (150 by 200 mm) on label or beside title block to record Contractor's review and approval markings and action taken by Architect.
 3. Include the following information for processing and recording action taken:
 - a. Project name.
 - b. Date.
 - c. Name of Contractor.
 - d. Name of subcontractor.
 - e. Name of supplier.
 - f. Name of manufacturer.
 - g. Submittal number or other unique identifier, including revision identifier.
 - 1) Submittal number shall use project number followed by Specification Section number followed by a decimal point and then a sequential number (e.g., 061000.01). Resubmittals shall include an alphabetic suffix after another decimal point (e.g., 061000.01.A).
 - h. Number and title of appropriate Specification Section.
 - i. Drawing number and detail references, as appropriate.
 - j. Location(s) where product is to be installed, as appropriate.
 - k. Other necessary identification.
4. Additional Paper Copies: Unless additional copies are required for final submittal, and unless Architect observes noncompliance with provisions in the Contract Documents, initial submittal may serve as final submittal.
5. Transmittal for Paper Submittals: Assemble each submittal individually and appropriately for transmittal and handling. Transmit each submittal using a transmittal form. Architect will discard submittals received from sources other than Contractor.

SECTION 013300 - SUBMITTAL PROCEDURES

- a. Transmittal Form for Paper Submittals: Use AIA Document G810 or a similar document.
- F. Electronic Submittals: Identify and incorporate information in each electronic submittal file as follows:
1. Provide a single Adobe Acrobat .PDF file for each specification section. Provide a transmittal form as first page of the submittal file. Provide bookmarks enabling navigation within the file to each submittal item. Incomplete submittals will be rejected.
 2. File name shall use Specification Section Number and Title and date submitted as YYMMDD. Resubmittals shall identify version of submittal by application of suffix "v" and the number of the resubmittal. (For example a second submittal of Section 96813 Tile Carpeting submitted on Jan 25, 2019 should be saved as "96813v2 Tile Carpeting 190125")
 3. Provide means for insertion to permanently record Contractor's review and approval markings and action taken by Architect.
 4. Transmittal Form for Electronic Submittals: Use electronic form acceptable to Owner, containing the following information:
 - a. Project name.
 - b. Date.
 - c. Name of Contractor.
 - d. Name of firm or entity that prepared submittal.
 - e. Names of subcontractor, manufacturer, and supplier.
 - f. Category and type of submittal.
 - g. Submittal purpose and description.
- G. Options: Identify options requiring selection by Architect.
- H. Deviations and Additional Information: On an attached separate sheet, prepared on Contractor's letterhead, record relevant information, requests for data, revisions other than those requested by Architect on previous submittals, and deviations from requirements in the Contract Documents, including minor variations and limitations. Include same identification information as related submittal.
- I. Resubmittals: Make resubmittals in same form and number of copies as initial submittal.
1. Note date and content of previous submittal.
 2. Note date and content of revision in label or title block and clearly indicate extent of revision.
 3. Resubmit submittals until they are marked with approval notation from Architect's action stamp.
 4. Resubmittals shall be complete and partial resubmittals of corrected or additional information will not be accepted. Resubmittals shall contain all submittal information required for the specification section.
- J. Distribution: Furnish copies of final submittals to manufacturers, subcontractors, suppliers, fabricators, installers, authorities having jurisdiction, and others as necessary for performance of construction activities. Show distribution on transmittal forms.

SECTION 013300 - SUBMITTAL PROCEDURES

- K. Use for Construction: Retain complete copies of submittals on Project site. Use only final action submittals that are marked with approval notation from Architect's action stamp.

PART 2 - PRODUCTS

2.1 SUBMITTAL PROCEDURES

- A. General Submittal Procedure Requirements: Prepare and submit submittals required by individual Specification Sections. Types of submittals are indicated in individual Specification Sections or Drawings.
 - 1. Post electronic submittals as PDF electronic files directly to designated site with automatic email notification to Architect or Submit electronic submittals via email as PDF electronic files.
 - a. Architect will return annotated file. Annotate and retain one copy of file as an electronic Project record document file.
 - 2. Action Submittals: Submit as PDF electronic file unless directed otherwise by the owner.
 - 3. Informational Submittals: Submit as PDF electronic file unless directed otherwise by the owner.
 - 4. Certificates and Certifications Submittals: Provide a statement that includes signature of entity responsible for preparing certification. Certificates and certifications shall be signed by an officer or other individual authorized to sign documents on behalf of that entity.
 - a. Provide a notarized statement on original paper copy certificates and certifications where indicated.
- B. Product Data: Provide product data for all specified products.
- C. Shop Drawings: Prepare Project-specific information, drawn accurately to scale for all custom fabrication work. Do not base Shop Drawings on reproductions of the Contract Documents or standard printed data.
 - 1. Preparation: Fully illustrate requirements in the Contract Documents. Include the following information, as applicable:
 - a. Identification of products.
 - b. Schedules.
 - c. Compliance with specified standards.
 - d. Notation of coordination requirements.
 - e. Notation of dimensions established by field measurement.
 - f. Relationship and attachment to adjoining construction clearly indicated.
 - g. Seal and signature of professional engineer if specified.
- D. Samples: Submit Samples for review of kind, color, pattern, and texture for a check of these characteristics with other elements and for a comparison of these characteristics between submittal and actual component as delivered and installed.

SECTION 013300 - SUBMITTAL PROCEDURES

1. Transmit each submittal using a transmittal form. Architect will discard submittals received from sources other than Contractor.
 - a. Transmittal Form for Sample Submittals: Use AIA Document G810 or a similar document.
2. Samples for Initial Selection: Submit manufacturer's color charts consisting of units or sections of units showing the full range of colors, textures, and patterns available.
 - a. Number of Samples: Submit one full set of available choices where color, pattern, texture, or similar characteristics are required to be selected from manufacturer's product line. Architect will return submittal with options selected.
3. Samples for Verification: Submit full-size units or Samples of size indicated, prepared from same material to be used for the Work, cured and finished in manner specified, and physically identical with material or product proposed for use, and that show full range of color and texture variations expected.
 - a. Number of Samples: Submit three sets of Samples. Architect will retain one Sample sets; remainder will be returned. Mark up and retain one returned Sample set as a project record sample.
- E. Coordination Drawing Submittals: Comply with requirements specified in Section 013100 "Project Management and Coordination."
- F. Contractor's Construction Schedule: Comply with requirements specified in Section 013200 "Construction Progress Documentation."
- G. Test and Inspection Reports and Schedule of Tests and Inspections Submittals: Comply with requirements specified in Section 014000 "Quality Requirements."
- H. Closeout Submittals and Maintenance Material Submittals: Comply with requirements specified in Section 017700 "Closeout Procedures."
- I. Maintenance Data: Comply with requirements specified in Section 017823 "Operation and Maintenance Data."
- J. Qualification Data: Prepare written information that demonstrates capabilities and experience of firm or person. Include lists of completed projects with project names and addresses, contact information of architects and owners, and other information specified.
- K. Welding Certificates: Prepare written certification that welding procedures and personnel comply with requirements in the Contract Documents. Submit record of Welding Procedure Specification and Procedure Qualification Record on AWS forms. Include names of firms and personnel certified.
- L. Installer Certificates: Submit written statements on manufacturer's letterhead certifying that Installer complies with requirements in the Contract Documents and, where required, is authorized by manufacturer for this specific Project.

SECTION 013300 - SUBMITTAL PROCEDURES

- M. Manufacturer Certificates: Submit written statements on manufacturer's letterhead certifying that manufacturer complies with requirements in the Contract Documents. Include evidence of manufacturing experience where required.
- N. Product Certificates: Submit written statements on manufacturer's letterhead certifying that product complies with requirements in the Contract Documents.
- O. Material Certificates: Submit written statements on manufacturer's letterhead certifying that material complies with requirements in the Contract Documents.
- P. Material Test Reports: Submit reports written by a qualified testing agency, on testing agency's standard form, indicating and interpreting test results of material for compliance with requirements in the Contract Documents.
- Q. Product Test Reports: Submit written reports indicating that current product produced by manufacturer complies with requirements in the Contract Documents. Base reports on evaluation of tests performed by manufacturer and witnessed by a qualified testing agency, or on comprehensive tests performed by a qualified testing agency.
- R. Research Reports: Submit written evidence, from a model code organization acceptable to authorities having jurisdiction, that product complies with building code in effect for Project.
- S. Preconstruction Test Reports: Submit reports written by a qualified testing agency, on testing agency's standard form, indicating and interpreting results of tests performed before installation of product, for compliance with performance requirements in the Contract Documents.
- T. Compatibility Test Reports: Submit reports written by a qualified testing agency, on testing agency's standard form, indicating and interpreting results of compatibility tests performed before installation of product. Include written recommendations for primers and substrate preparation needed for adhesion.
- U. Field Test Reports: Submit written reports indicating and interpreting results of field tests performed either during installation of product or after product is installed in its final location, for compliance with requirements in the Contract Documents.
- V. Design Data: Prepare and submit written and graphic information, including, but not limited to, performance and design criteria, list of applicable codes and regulations, and calculations. Include list of assumptions and other performance and design criteria and a summary of loads. Include load diagrams if applicable. Provide name and version of software, if any, used for calculations. Include page numbers.

2.2 DELEGATED-DESIGN SERVICES

- A. Performance and Design Criteria: Where professional design services or certifications by a design professional are specifically required of Contractor by the Contract Documents, provide products and systems complying with specific performance and design criteria indicated.
 - 1. If criteria indicated are not sufficient to perform services or certification required, submit a written request for additional information to Architect.

SECTION 013300 - SUBMITTAL PROCEDURES

- B. Delegated-Design Services Certification: In addition to Shop Drawings, Product Data, and other required submittals, submit digitally signed PDF electronic file copies of certificate, signed and sealed by the responsible design professional, for each product and system specifically assigned to Contractor to be designed or certified by a design professional.
 - 1. Indicate that products and systems comply with performance and design criteria in the Contract Documents. Include list of codes, loads, and other factors used in performing these services.

PART 3 - EXECUTION

3.1 GENERAL

- A. The contractor is responsible to assure submittals are correct and complete prior to submission for review. A maximum of two reviews by the design team is expected to be adequate to obtain approval. At the owner's discretion, costs for additional submittal review (in excess of two reviews) may be charged to the contractor. Charges will be withheld from contractor payments.

3.2 CONTRACTOR'S REVIEW

- A. Action and Informational Submittals: Review each submittal and check for coordination with other Work of the Contract and for compliance with the Contract Documents. Note corrections and field dimensions. Mark with approval stamp before submitting to Architect.
- B. Project Closeout and Maintenance Material Submittals: See requirements in Section 017700 "Closeout Procedures."
- C. Approval Stamp: Stamp each submittal with a uniform, approval stamp. Include Project name and location, submittal number, Specification Section title and number, name of reviewer, date of Contractor's approval, and statement certifying that submittal has been reviewed, checked, and approved for compliance with the Contract Documents.

3.3 ARCHITECT'S ACTION

- A. Action Submittals: Architect will review each submittal, make marks to indicate corrections or revisions required, and return it. Architect will stamp each submittal with an action stamp and will mark stamp appropriately to indicate action.
- B. Informational Submittals: Architect will review each submittal and will not return it, or will return it if it does not comply with requirements. Architect will forward each submittal to appropriate party.
- C. Partial submittals prepared for a portion of the Work will only be reviewed when use of partial submittals has received prior approval from Architect.
- D. Incomplete submittals are unacceptable, will be considered nonresponsive, and will be returned for resubmittal without review.

SECTION 013300 - SUBMITTAL PROCEDURES

- E. Submittals not required by the Contract Documents may be returned by the Architect without action.
- F. Approval of a submittal that deviates from the Construction Documents does not relieve the Contractor of their responsibility to perform the Work in accordance with the Construction Documents.

END OF SECTION

SECTION 014000 - QUALITY REQUIREMENTS

PART 1 - GENERAL

1.1 RELATED DOCUMENTS

- A. Drawings and general provisions of the Contract, including General and Supplementary Conditions and other Division 01 Specification Sections, apply to this Section.

1.2 SUMMARY

- A. Section includes administrative and procedural requirements for quality assurance and quality control.
- B. Testing and inspecting services are required to verify compliance with requirements specified or indicated. These services do not relieve Contractor of responsibility for compliance with the Contract Document requirements.
 - 1. Specific quality-assurance and -control requirements for individual construction activities are specified in the Sections that specify those activities. Requirements in those Sections may also cover production of standard products.
 - 2. Specified tests, inspections, and related actions do not limit Contractor's other quality-assurance and -control procedures that facilitate compliance with the Contract Document requirements.
 - 3. Requirements for Contractor to provide quality-assurance and -control services required by Architect, Owner, Commissioning Authority, or authorities having jurisdiction are not limited by provisions of this Section.
 - 4. Specific test and inspection requirements are not specified in this Section.

1.3 DEFINITIONS

- A. Quality-Assurance Services: Activities, actions, and procedures performed before and during execution of the Work to guard against defects and deficiencies and substantiate that proposed construction will comply with requirements.
- B. Quality-Control Services: Tests, inspections, procedures, and related actions during and after execution of the Work to evaluate that actual products incorporated into the Work and completed construction comply with requirements. Services do not include contract enforcement activities performed by Architect or Owner's Representative.
- C. Preconstruction Testing: Tests and inspections performed specifically for Project before products and materials are incorporated into the Work, to verify performance or compliance with specified criteria.
- D. Product Testing: Tests and inspections that are performed by an NRTL, an NVLAP, or a testing agency qualified to conduct product testing and acceptable to authorities having jurisdiction, to establish product performance and compliance with specified requirements.

SECTION 014000 - QUALITY REQUIREMENTS

- E. Source Quality-Control Testing: Tests and inspections that are performed at the source, e.g., plant, mill, factory, or shop.
- F. Field Quality-Control Testing: Tests and inspections that are performed on-site for installation of the Work and for completed Work.
- G. Testing Agency: An entity engaged to perform specific tests, inspections, or both. Testing laboratory shall mean the same as testing agency.
- H. Installer/Applicator/Erector: Contractor or another entity engaged by Contractor as an employee, Subcontractor, or Sub-subcontractor, to perform a particular construction operation, including installation, erection, application, and similar operations.
 - 1. Use of trade-specific terminology in referring to a trade or entity does not require that certain construction activities be performed by accredited or unionized individuals, or that requirements specified apply exclusively to specific trade(s).
- I. Experienced: When used with an entity or individual, "experienced" means having successfully completed a minimum of five previous projects similar in nature, size, and extent to this Project; being familiar with special requirements indicated; and having complied with requirements of authorities having jurisdiction.

1.4 CONFLICTING REQUIREMENTS

- A. Referenced Standards: If compliance with two or more standards is specified and the standards establish different or conflicting requirements for minimum quantities or quality levels, comply with the most stringent requirement. Refer conflicting requirements that are different, but apparently equal, to Architect for a decision before proceeding.
- B. Minimum Quantity or Quality Levels: The quantity or quality level shown or specified shall be the minimum provided or performed. The actual installation may comply exactly with the minimum quantity or quality specified, or it may exceed the minimum within reasonable limits. To comply with these requirements, indicated numeric values are minimum or maximum, as appropriate, for the context of requirements. Refer uncertainties to Architect for a decision before proceeding.

1.5 REPORTS AND DOCUMENTS

- A. Test and Inspection Reports: Prepare and submit certified written reports specified in other Sections. Include the following:
 - 1. Date of issue.
 - 2. Project title and number.
 - 3. Name, address, and telephone number of testing agency.
 - 4. Dates and locations of samples and tests or inspections.
 - 5. Names of individuals making tests and inspections.
 - 6. Description of the Work and test and inspection method.
 - 7. Identification of product and Specification Section.
 - 8. Complete test or inspection data.

SECTION 014000 - QUALITY REQUIREMENTS

9. Test and inspection results and an interpretation of test results.
10. Record of temperature and weather conditions at time of sample taking and testing and inspecting.
11. Comments or professional opinion on whether tested or inspected Work complies with the Contract Document requirements.
12. Name and signature of laboratory inspector.
13. Recommendations on retesting and reinspecting.

- B. Permits, Licenses, and Certificates: For Owner's records, submit copies of permits, licenses, certifications, inspection reports, releases, jurisdictional settlements, notices, receipts for fee payments, judgments, correspondence, records, and similar documents, established for compliance with standards and regulations bearing on performance of the Work.

1.6 QUALITY ASSURANCE

- A. General: Qualifications paragraphs in this article establish the minimum qualification levels required; individual Specification Sections specify additional requirements.
- B. Manufacturer Qualifications: A firm experienced in manufacturing products or systems similar to those indicated for this Project and with a record of successful in-service performance, as well as sufficient production capacity to produce required units.
- C. Fabricator Qualifications: A firm experienced in producing products similar to those indicated for this Project and with a record of successful in-service performance, as well as sufficient production capacity to produce required units.
- D. Installer Qualifications: A firm or individual experienced in installing, erecting, or assembling work similar in material, design, and extent to that indicated for this Project, whose work has resulted in construction with a record of successful in-service performance.
- E. Specialists: Certain Specification Sections require that specific construction activities shall be performed by entities who are recognized experts in those operations. Specialists shall satisfy qualification requirements indicated and shall be engaged for the activities indicated.
1. Requirements of authorities having jurisdiction shall supersede requirements for specialists.
- F. Manufacturer's Technical Representative Qualifications: An authorized representative of manufacturer who is trained and approved by manufacturer to observe and inspect installation of manufacturer's products that are similar in material, design, and extent to those indicated for this Project.
- G. Factory-Authorized Service Representative Qualifications: An authorized representative of manufacturer who is trained and approved by manufacturer to inspect installation of manufacturer's products that are similar in material, design, and extent to those indicated for this Project.
- H. Preconstruction Testing: Where testing agency is indicated to perform preconstruction testing for compliance with specified requirements for performance and test methods, comply with the following:

SECTION 014000 - QUALITY REQUIREMENTS

1. Contractor responsibilities include the following:
 - a. Provide test specimens representative of proposed products and construction.
 - b. Submit specimens in a timely manner with sufficient time for testing and analyzing results to prevent delaying the Work.
 - c. Provide sizes and configurations of test assemblies, mockups, and laboratory mockups to adequately demonstrate capability of products to comply with performance requirements.
 - d. Build laboratory mockups at testing facility using personnel, products, and methods of construction indicated for the completed Work.
 - e. When testing is complete, remove test specimens, assemblies, and mockups; do not reuse products on Project.
2. Testing Agency Responsibilities: Submit a certified written report of each test, inspection, and similar quality-assurance service to Architect and Commissioning Authority, through Owner's Representative, with copy to Contractor. Interpret tests and inspections and state in each report whether tested and inspected work complies with or deviates from the Contract Documents.

1.7 QUALITY CONTROL

- A. Owner Responsibilities: Where quality-control services are indicated as Owner's responsibility, Owner will engage a qualified testing agency to perform these services.
 1. Owner will furnish Contractor with names, addresses, and telephone numbers of testing agencies engaged and a description of types of testing and inspecting they are engaged to perform.
 2. Costs for retesting and reinspecting construction that replaces or is necessitated by work that failed to comply with the Contract Documents will be charged to Contractor, and the Contract Sum will be adjusted by Change Order.
- B. Contractor Responsibilities: Tests and inspections not explicitly assigned to Owner are Contractor's responsibility. Perform additional quality-control activities required to verify that the Work complies with requirements, whether specified or not.
 1. Unless otherwise indicated, provide quality-control services specified and those required by authorities having jurisdiction. Perform quality-control services required of Contractor by authorities having jurisdiction, whether specified or not.
 2. Where services are indicated as Contractor's responsibility, engage a qualified testing agency to perform these quality-control services.
 3. Notify testing agencies at least 24 hours in advance of time when Work that requires testing or inspecting will be performed.
 4. Where quality-control services are indicated as Contractor's responsibility, submit a certified written report, in duplicate, of each quality-control service.
 5. Testing and inspecting requested by Contractor and not required by the Contract Documents are Contractor's responsibility.
 6. Submit additional copies of each written report directly to authorities having jurisdiction, when they so direct.

SECTION 014000 - QUALITY REQUIREMENTS

- C. Retesting/Reinspecting: Regardless of whether original tests or inspections were Contractor's responsibility, provide quality-control services, including retesting and reinspecting, for construction that replaced Work that failed to comply with the Contract Documents.
- D. Schedule of Tests and Inspections: Prepare a schedule of tests, inspections, and similar quality-control services required by the Contract Documents. Coordinate and submit concurrently with Contractor's construction schedule. Update as the Work progresses.
 - 1. Distribution: Distribute schedule to Owner, Architect, Commissioning Authority, testing agencies, and each party involved in performance of portions of the Work where tests and inspections are required.

1.8 SPECIAL TESTS AND INSPECTIONS

- A. Special Tests and Inspections: Unless otherwise noted, the Owner will engage a qualified special inspector to conduct special tests and inspections required by authorities having jurisdiction as follows:
 - 1. Notifying Architect and Contractor through Owner's Representative promptly of irregularities and deficiencies observed in the Work during performance of its services.
 - 2. Submitting a certified written report of each test, inspection, and similar quality-control service to Architect through Owner's Representative with copy to Contractor and to authorities having jurisdiction.
 - 3. Submitting a final report of special tests and inspections at Substantial Completion, which includes a list of unresolved deficiencies.
 - 4. Interpreting tests and inspections and stating in each report whether tested and inspected work complies with or deviates from the Contract Documents.
 - 5. Retesting and reinspecting corrected work.

PART 2 - PRODUCTS (Not Used)

PART 3 - EXECUTION

3.1 TEST AND INSPECTION LOG

- A. Test and Inspection Log: Prepare a record of tests and inspections. Include the following:
 - 1. Date test or inspection was conducted.
 - 2. Description of the Work tested or inspected.
 - 3. Date test or inspection results were transmitted to Architect.
 - 4. Identification of testing agency or special inspector conducting test or inspection.
- B. Maintain log at Project site. Post changes and revisions as they occur. Provide access to test and inspection log for Architect's reference during normal working hours.

SECTION 014000 - QUALITY REQUIREMENTS

3.2 REPAIR AND PROTECTION

- A. General: On completion of testing, inspecting, sample taking, and similar services, repair damaged construction and restore substrates and finishes.
 - 1. Provide materials and comply with installation requirements specified in other Specification Sections or matching existing substrates and finishes. Restore patched areas and extend restoration into adjoining areas with durable seams that are as invisible as possible. Comply with the Contract Document requirements for cutting and patching in Section 017300 "Execution."
- B. Protect construction exposed by or for quality-control service activities.
- C. Repair and protection are Contractor's responsibility, regardless of the assignment of responsibility for quality-control services.

END OF SECTION

SECTION 014200 - REFERENCES

PART 1 - GENERAL

1.1 RELATED DOCUMENTS

- A. Drawings and general provisions of the Contract, including General and Supplementary Conditions and other Division 01 Specification Sections, apply to this Section.

1.2 DEFINITIONS

- A. General: Basic Contract definitions are included in the Conditions of the Contract.
- B. "Approved": When used to convey Architect's action on Contractor's submittals, applications, and requests, "approved" is limited to Architect's duties and responsibilities as stated in the Conditions of the Contract.
- C. "Conforms to Design": When used to convey Architect's action on Contractor's submittals, applications, and requests, "conforms to design" is limited to Architect's duties and responsibilities as stated in the Conditions of the Contract.
- D. "Directed": A command or instruction by Architect. Other terms including "requested," "authorized," "selected," "required," and "permitted" have the same meaning as "directed."
- E. "Indicated": Requirements expressed by graphic representations or in written form on Drawings, in Specifications, and in other Contract Documents. Other terms including "shown," "noted," "scheduled," and "specified" have the same meaning as "indicated."
- F. "Regulations": Laws, ordinances, statutes, and lawful orders issued by authorities having jurisdiction, and rules, conventions, and agreements within the construction industry that control performance of the Work.
- G. "Furnish": Supply and deliver to Project site, ready for unloading, unpacking, assembly, installation, and similar operations.
- H. "Install": Operations at Project site including unloading, temporarily storing, unpacking, assembling, erecting, placing, anchoring, applying, working to dimension, finishing, curing, protecting, cleaning, and similar operations.
- I. "Provide": Furnish and install, complete and ready for the intended use.
- J. "Project Site": Space available for performing construction activities. The extent of Project site is shown on Drawings and may or may not be identical with the description of the land on which Project is to be built.

1.3 INDUSTRY STANDARDS

- A. Applicability of Standards: Unless the Contract Documents include more stringent requirements, applicable construction industry standards have the same force and effect as if

SECTION 014200 - REFERENCES

bound or copied directly into the Contract Documents to the extent referenced. Such standards are made a part of the Contract Documents by reference.

- B. Publication Dates: Comply with standards in effect as of date of the Contract Documents unless otherwise indicated.
- C. Copies of Standards: Each entity engaged in construction on Project should be familiar with industry standards applicable to its construction activity. Copies of applicable standards are not bound with the Contract Documents.
 - 1. Where copies of standards are needed to perform a required construction activity, obtain copies directly from publication source.

1.4 ABBREVIATIONS AND ACRONYMS

- A. Industry Organizations: Where abbreviations and acronyms are used in Specifications or other Contract Documents, they shall mean the recognized name of the entities indicated in Thomson Gale's "Encyclopedia of Associations" or in Columbia Books' "National Trade & Professional Associations of the U.S."
- B. Code Agencies: Where abbreviations and acronyms are used in Specifications or other Contract Documents, they shall mean the recognized name of the entities in the following list. Names, telephone numbers, and Web sites are subject to change and are believed to be accurate and up-to-date as of the date of the Contract Documents.
- C. Federal Government Agencies: Where abbreviations and acronyms are used in Specifications or other Contract Documents, they shall mean the recognized name of the entities in the following list. Names, telephone numbers, and Web sites are subject to change and are believed to be accurate and up-to-date as of the date of the Contract Documents.
- D. Standards and Regulations: Where abbreviations and acronyms are used in Specifications or other Contract Documents, they shall mean the recognized name of the standards and regulations in the following list. Names, telephone numbers, and Web sites are subject to change and are believed to be accurate and up-to-date as of the date of the Contract Documents.
- E. State Government Agencies: Where abbreviations and acronyms are used in Specifications or other Contract Documents, they shall mean the recognized name of the entities in the following list. Names, telephone numbers, and Web sites are subject to change and are believed to be accurate and up-to-date as of the date of the Contract Documents.

PART 2 - PRODUCTS (Not Used)

PART 3 - EXECUTION (Not Used)

END OF SECTION

SECTION 015000 - TEMPORARY FACILITIES AND CONTROLS

PART 1 - GENERAL

1.1 RELATED DOCUMENTS

- A. Drawings and general provisions of the Contract, including General and Supplementary Conditions and other Division 01 Specification Sections, apply to this Section.

1.2 SUMMARY

- A. Section includes requirements for temporary utilities, support facilities, and security and protection facilities.
- B. Related Requirements:
 - 1. Section 011000 "Summary" for work restrictions and limitations on utility interruptions.

1.3 USE CHARGES

- A. Electric Power Service: Contractor may use existing building power as long as their use does not interrupt occupants use or damage any systems.
- B. Water and Sewer Service: Contractor may use existing building's water for construction operations as long as their use does not interrupt occupants use or damage any systems.

1.4 SUBMITTALS

- A. Site Plan: Provide a site plan that shows locations of utility connections, location of temporary HVAC or filters at supply and return grills, staging areas, and parking areas for construction personnel. Should construction sequencing or phasing alter the locations of the above, then secondary plans showing revised locations are required. Coordinate this site plan with the Contract Drawings.

1.5 QUALITY ASSURANCE

- A. Electric Service: Comply with NECA, NEMA, and UL standards and regulations for temporary electric service. Install service to comply with NFPA 70.
- B. Tests, Permits, & Inspections: Obtain required permits, tests, and inspections from authorities having jurisdiction for each temporary utility prior to use.

SECTION 015000 - TEMPORARY FACILITIES AND CONTROLS

1.6 PROJECT CONDITIONS

- A. Temporary Use of Permanent Facilities: Installer of each permanent service shall assume responsibility for operation, maintenance, and protection of each permanent service during its use as a construction facility before Owner's acceptance, regardless of previously assigned responsibilities.

PART 2 - PRODUCTS

2.1 MATERIALS

- A. Portable Chain-Link Fencing: Minimum 2-inch, 0.148-inch- thick, galvanized-steel, chain-link fabric fencing; minimum 6 feet high with galvanized-steel pipe posts; minimum 2-3/8-inch- OD line posts and 2-7/8-inch- OD corner and pull posts, with 1-5/8-inch- OD top and bottom rails. Provide galvanized-steel bases for supporting posts.

2.2 EQUIPMENT

- A. Fire Extinguishers: Portable, UL rated; with class and extinguishing agent as required by locations and classes of fire exposures.
- B. HVAC Equipment: Unless Owner authorizes use of permanent HVAC system, provide vented, self-contained, liquid-propane-gas or fuel-oil heaters with individual space thermostatic control.
 - 1. Use of gasoline-burning space heaters, open-flame heaters, or salamander-type heating units is prohibited.
 - 2. Heating Units: Listed and labeled for type of fuel being consumed, by a qualified testing agency acceptable to authorities having jurisdiction, and marked for intended location and application.
 - 3. Permanent HVAC System: Use of permanent HVAC systems during construction is prohibited. Isolated short term use can occur if approved in writing by the Owners representative. If Owner authorizes use of permanent HVAC system for temporary use during construction, provide filter with MERV of 8 at each return-air grille in system and remove at end of construction and clean HVAC system as required in Section 017700 "Closeout Procedures".
- C. Air-Filtration Units: Primary and secondary HEPA-filter-equipped portable units with four-stage filtration. Provide single switch for emergency shutoff. Configure to run continuously.

SECTION 015000 - TEMPORARY FACILITIES AND CONTROLS

PART 3 - EXECUTION

3.1 INSTALLATION, GENERAL

- A. Locate facilities where they will serve Project adequately and result in minimum interference with performance of the Work. Relocate and modify facilities as required by progress of the Work.

3.2 TEMPORARY UTILITY INSTALLATION

- A. General: Install temporary service or connect to existing service.
 - 1. Arrange with utility company, Owner, and existing users for time when service can be interrupted, if necessary, to make connections for temporary services.
- B. Sanitary Facilities: The Contractor may use public restrooms on a keep clean basis.
- C. Heating and Cooling: Provide temporary heating and cooling required by construction activities for curing or drying of completed installations or for protecting installed construction from adverse effects of low temperatures or high humidity. Select equipment that will not have a harmful effect on completed installations or elements being installed.
- D. Ventilation and Humidity Control: Provide temporary ventilation required by construction activities for curing or drying of completed installations or for protecting installed construction from adverse effects of high humidity. Select equipment that will not have a harmful effect on completed installations or elements being installed. Coordinate ventilation requirements to produce ambient condition required and minimize energy consumption. **Note: All existing ventilation and lighting shall be protected during all demolition and construction activities.**
- E. Electric Power Service: Provide electric power service and distribution system of sufficient size, capacity, and power characteristics required for construction operations.
- F. Lighting: Provide temporary lighting with local switching that provides adequate illumination for construction operations, observations, inspections, and traffic conditions.
 - 1. Install and operate temporary lighting that fulfills security and protection requirements without operating entire system.

3.3 SUPPORT FACILITIES INSTALLATION

- A. General: Comply with the following:
 - 1. Maintain support facilities until Architect schedules Substantial Completion inspection. Remove before Substantial Completion. Personnel remaining after Substantial

SECTION 015000 - TEMPORARY FACILITIES AND CONTROLS

Completion will be permitted to use permanent facilities, under conditions acceptable to Owner.

- B. Traffic Controls: Comply with requirements of authorities having jurisdiction.
 - 1. Maintain access for fire-fighting equipment and access to fire hydrants.
- C. Parking: Limit parking to areas designated as contractor staging areas.
- D. Waste Disposal Facilities: Provide waste-collection containers in sizes adequate to handle waste from construction operations. Comply with requirements of authorities having jurisdiction. Comply with progress cleaning requirements in Section 017300 "Execution."

3.4 SECURITY AND PROTECTION FACILITIES INSTALLATION

- A. Environmental Protection: Comply with requirements specified in Division 31 Section "Temporary Environmental Controls."
 - 1. Comply with work restrictions specified in Division 1 Section "Summary."
- B. Security Enclosure and Lockup: Install substantial temporary enclosure around partially completed areas of construction. Provide lockable entrances to prevent unauthorized entrance, vandalism, theft, and similar violations of security.
- C. Barricades, Warning Signs, and Lights: Comply with requirements of authorities having jurisdiction for erecting structurally adequate barricades, including warning signs and lighting.
- D. Temporary Enclosures: Provide temporary enclosures for protection of construction, in progress and completed, from exposure, foul weather, other construction operations, and similar activities. Provide temporary weathertight enclosure for building exterior.
 - 1. Where heating or cooling is needed and permanent enclosure is not complete, insulate temporary enclosures.
- E. Temporary Fire Protection: Install and maintain temporary fire-protection facilities of types needed to protect against reasonably predictable and controllable fire losses. Comply with NFPA 241.
 - 1. Prohibit smoking in construction areas.
 - 2. Supervise welding operations, combustion-type temporary heating units, and similar sources of fire ignition according to requirements of authorities having jurisdiction.
 - 3. Develop and supervise an overall fire-prevention and -protection program for personnel at Project site. Review needs with local fire department and establish procedures to be followed. Instruct personnel in methods and procedures. Post warnings and information.
 - 4. Provide temporary standpipes and hoses for fire protection. Hang hoses with a warning sign stating that hoses are for fire-protection purposes only and are not to be removed. Match hose size with outlet size and equip with suitable nozzles.

SECTION 015000 - TEMPORARY FACILITIES AND CONTROLS

- F. Protection of Existing Facilities: Protect existing, equipment, structures, utilities, and other improvements at Project site and on adjacent properties, except those indicated to be removed or altered. Repair damage to existing facilities.

3.5 MOISTURE AND MOLD CONTROL

- A. Contractor's Moisture-Protection Plan: Avoid trapping water in finished work. Document visible signs of mold that may appear during construction.
- B. Exposed Construction Phase: Before installation of weather barriers, when materials are subject to wetting and exposure and to airborne mold spores, protect as follows:
 - 1. Protect porous materials from water damage.
 - 2. Protect stored and installed material from flowing or standing water.
 - 3. Keep porous and organic materials from coming into prolonged contact with concrete.
 - 4. Remove standing water from decks.
 - 5. Keep deck openings covered or dammed.

3.6 OPERATION, TERMINATION, AND REMOVAL

- A. Supervision: Enforce strict discipline in use of temporary facilities. To minimize waste and abuse, limit availability of temporary facilities to essential and intended uses.
- B. Maintenance: Maintain facilities in good operating condition until removal.
 - 1. Maintain operation of temporary enclosures, heating, cooling, humidity control, ventilation, and similar facilities on a 24-hour basis where required to achieve indicated results and to avoid possibility of damage.
 - 2. Maintain Owner's onsite field office as required to allow full use of the facility for the duration of the project.
- C. Temporary Facility Changeover: Do not change over from using temporary security and protection facilities to permanent facilities until Substantial Completion.
- D. Termination and Removal: Remove each temporary facility when need for its service has ended, when it has been replaced by authorized use of a permanent facility, or no later than Substantial Completion. Complete or, if necessary, restore permanent construction that may have been delayed because of interference with temporary facility. Repair damaged Work, clean exposed surfaces, and replace construction that cannot be satisfactorily repaired.
 - 1. Materials and facilities that constitute temporary facilities are property of Contractor. Owner reserves right to take possession of Project identification signs.
 - 2. At Substantial Completion, repair, renovate, and clean permanent facilities used during construction period. Comply with final cleaning requirements specified in Section 017700 "Closeout Procedures."

END OF SECTION

SECTION 016000 - PRODUCT REQUIREMENTS

PART 1 - GENERAL

1.1 RELATED DOCUMENTS

- A. Drawings and general provisions of the Contract, including General and Supplementary Conditions and other Division 01 Specification Sections, apply to this Section.

1.2 SUMMARY

- A. Section includes administrative and procedural requirements for selection of products for use in Project; product delivery, storage, and handling; manufacturers' standard warranties on products; special warranties; and comparable products.
- B. Related Requirements:
 - 1. Section 012500 "Substitution Procedures" for requests for substitutions.

1.3 DEFINITIONS

- A. Products: Items obtained for incorporating into the Work, whether purchased for Project or taken from previously purchased stock. The term "product" includes the terms "material," "equipment," "system," and terms of similar intent.
 - 1. Named Products: Items identified by manufacturer's product name, including make or model number or other designation shown or listed in manufacturer's published product literature, that is current as of date of the Contract Documents.
 - 2. New Products: Items that have not previously been incorporated into another project or facility. Products salvaged or recycled from other projects are not considered new products.
 - 3. Comparable Product: Product that is demonstrated and approved through submittal process to have the indicated qualities related to type, function, dimension, in-service performance, physical properties, appearance, and other characteristics that equal or exceed those of specified product.
- B. Basis-of-Design Product Specification: A specification in which a specific manufacturer's product is named and accompanied by the words "basis-of-design product," including make or model number or other designation, to establish the significant qualities related to type, function, dimension, in-service performance, physical properties, appearance, and other characteristics for purposes of evaluating comparable products of additional manufacturers named in the specification.

1.4 ACTION SUBMITTALS

- A. Comparable Product Requests: Submit request for consideration of each comparable product. Identify product or fabrication or installation method to be replaced. Include Specification Section number and title and Drawing numbers and titles.

SECTION 016000 - PRODUCT REQUIREMENTS

1. Include data to indicate compliance with the requirements specified in "Comparable Products" Article.
2. Architect's Action: If necessary, Architect will request additional information or documentation for evaluation within one week of receipt of a comparable product request. Architect will notify Contractor through Owner's Representative of approval or rejection of proposed comparable product request within 15 days of receipt of request, or seven days of receipt of additional information or documentation, whichever is later.
 - a. Form of Approval: As specified in Section 013300 "Submittal Procedures."
 - b. Use product specified if Architect does not issue a decision on use of a comparable product request within time allocated.
- B. Basis-of-Design Product Specification Submittal: Comply with requirements in Section 013300 "Submittal Procedures." Show compliance with requirements.

1.5 PRODUCT DELIVERY, STORAGE, AND HANDLING

- A. Deliver, store, and handle products using means and methods that will prevent damage, deterioration, and loss, including theft and vandalism. Comply with manufacturer's written instructions.
- B. Delivery and Handling:
 1. Schedule delivery to minimize long-term storage at Project site and to prevent overcrowding of construction spaces.
 2. Coordinate delivery with installation time to ensure minimum holding time for items that are flammable, hazardous, easily damaged, or sensitive to deterioration, theft, and other losses.
 3. Deliver products to Project site in an undamaged condition in manufacturer's original sealed container or other packaging system, complete with labels and instructions for handling, storing, unpacking, protecting, and installing.
 4. Inspect products on delivery to determine compliance with the Contract Documents and to determine that products are undamaged and properly protected.
- C. Storage:
 1. Store products to allow for inspection and measurement of quantity or counting of units.
 2. Store materials in a manner that will not endanger Project structure.
 3. Store products that are subject to damage by the elements, under cover in a weather tight enclosure above ground, with ventilation adequate to prevent condensation.
 4. Protect foam plastic from exposure to sunlight, except to extent necessary for period of installation and concealment.
 5. Comply with product manufacturer's written instructions for temperature, humidity, ventilation, and weather-protection requirements for storage.
 6. Protect stored products from damage and liquids from freezing.

SECTION 016000 - PRODUCT REQUIREMENTS

1.6 PRODUCT WARRANTIES

- A. Warranties specified in other Sections shall be in addition to, and run concurrent with, other warranties required by the Contract Documents. Manufacturer's disclaimers and limitations on product warranties do not relieve Contractor of obligations under requirements of the Contract Documents.
 - 1. Manufacturer's Warranty: Written warranty furnished by individual manufacturer for a particular product and specifically endorsed by manufacturer to Owner.
 - 2. Special Warranty: Written warranty required by the Contract Documents to provide specific rights for Owner.
- B. Special Warranties: Prepare a written document that contains appropriate terms and identification, ready for execution.
 - 1. Manufacturer's Standard Form: Modified to include Project-specific information and properly executed.
 - 2. Specified Form: When specified forms are included with the Specifications, prepare a written document using indicated form properly executed.
 - 3. See other Sections for specific content requirements and particular requirements for submitting special warranties.
- C. Submittal Time: Comply with requirements in Section 017700 "Closeout Procedures."

PART 2 - PRODUCTS

2.1 PRODUCT SELECTION PROCEDURES

- A. General Product Requirements: Provide products that comply with the Contract Documents, are undamaged and, unless otherwise indicated, are new at time of installation.
 - 1. Provide products complete with accessories, trim, finish, fasteners, and other items needed for a complete installation and indicated use and effect.
 - 2. Standard Products: If available, and unless custom products or nonstandard options are specified, provide standard products of types that have been produced and used successfully in similar situations on other projects.
 - 3. Owner reserves the right to limit selection to products with warranties not in conflict with requirements of the Contract Documents.
 - 4. Where products are accompanied by the term "as selected," Architect will make selection.
 - 5. Descriptive, performance, and reference standard requirements in the Specifications establish salient characteristics of products.
 - 6. Or Equal: For products specified by name and accompanied by the term "or equal," or "or approved equal," or "or approved," comply with requirements in "Comparable Products" Article to obtain approval for use of an unnamed product.
- B. Product Selection Procedures:

SECTION 016000 - PRODUCT REQUIREMENTS

1. Product: Where Specifications name a single manufacturer and product, provide the named product that complies with requirements. Comparable products or substitutions for Contractor's convenience will not be considered.
 2. Manufacturer/Source: Where Specifications name a single manufacturer or source, provide a product by the named manufacturer or source that complies with requirements. Comparable products or substitutions for Contractor's convenience will not be considered.
 3. Products:
 - a. Restricted List: Where Specifications include a list of names of both manufacturers and products, provide one of the products listed that complies with requirements. Comparable products or substitutions for Contractor's convenience will not be considered unless otherwise indicated.
 - b. Nonrestricted List: Where Specifications include a list of names of both available manufacturers and products, provide one of the products listed, or an unnamed product, that complies with requirements. Comply with requirements in "Comparable Products" Article for consideration of an unnamed product.
 4. Manufacturers:
 - a. Restricted List: Where Specifications include a list of manufacturers' names, provide a product by one of the manufacturers listed that complies with requirements. Comparable products or substitutions for Contractor's convenience will not be considered unless otherwise indicated.
 - b. Nonrestricted List: Where Specifications include a list of available manufacturers, provide a product by one of the manufacturers listed, or a product by an unnamed manufacturer, that complies with requirements. Comply with requirements in "Comparable Products" Article for consideration of an unnamed manufacturer's product.
 5. Basis-of-Design Product: Where Specifications name a product, or refer to a product indicated on Drawings, and include a list of manufacturers, provide the specified or indicated product or a comparable product by one of the other named manufacturers. Drawings and Specifications indicate sizes, profiles, dimensions, and other characteristics that are based on the product named. Comply with requirements in "Comparable Products" Article for consideration of an unnamed product by one of the other named manufacturers.
- C. Visual Matching Specification: Where Specifications require "match Architect's sample", provide a product that complies with requirements and matches Architect's sample. Architect's decision will be final on whether a proposed product matches.
1. If no product available within specified category matches and complies with other specified requirements, comply with requirements in Section 012500 "Substitution Procedures" for proposal of product.
- D. Visual Selection Specification: Where Specifications include the phrase "as selected by Architect from manufacturer's full range" or similar phrase, select a product that complies with requirements. Architect will select color, gloss, pattern, density, or texture from manufacturer's product line that includes both standard and premium items.

SECTION 016000 - PRODUCT REQUIREMENTS

2.2 COMPARABLE PRODUCTS

- A. Conditions for Consideration: Architect will consider Contractor's request for comparable product when the following conditions are satisfied. If the following conditions are not satisfied, Architect may return requests without action, except to record noncompliance with these requirements:
1. Evidence that the proposed product does not require revisions to the Contract Documents, that it is consistent with the Contract Documents and will produce the indicated results, and that it is compatible with other portions of the Work.
 2. Detailed comparison of significant qualities of proposed product with those named in the Specifications. Significant qualities include attributes such as performance, weight, size, durability, visual effect, and specific features and requirements indicated.
 3. Evidence that proposed product provides specified warranty.
 4. List of similar installations for completed projects with project names and addresses and names and addresses of architects and owners, if requested.
 5. Samples, if requested.

PART 3 - EXECUTION (Not Used)

END OF SECTION

SECTION 017300 - EXECUTION

PART 1 - GENERAL

1.1 RELATED DOCUMENTS

- A. Drawings and general provisions of the Contract, including General and Supplementary Conditions and other Division 01 Specification Sections, apply to this Section.

1.2 SUMMARY

- A. Section includes general administrative and procedural requirements governing execution of the Work including, but not limited to, the following:
 - 1. Installation of the Work.
 - 2. Cutting and patching.
 - 3. Progress cleaning.
 - 4. Starting and adjusting.
 - 5. Protection of installed construction.
 - 6. Correction of the Work.
- B. Related Requirements:
 - 1. Section 011000 "Summary" for limits on use of Project site.

1.3 DEFINITIONS

- A. Cutting: Removal of in-place construction necessary to permit installation or performance of other work.
- B. Patching: Fitting and repair work required to restore construction to original conditions after installation of other work.

PART 2 - PRODUCTS

2.1 MATERIALS

- A. In-Place Materials: Use materials for patching identical to in-place materials. For exposed surfaces, use materials that visually match in-place adjacent surfaces to the fullest extent possible.
 - 1. If identical materials are unavailable or cannot be used, use materials that, when installed, will provide a match acceptable to Architect for the visual and functional performance of in-place materials.

SECTION 017300 - EXECUTION

PART 3 - EXECUTION

3.1 EXAMINATION

- A. Existing Conditions: The existence and location of underground and other utilities and construction indicated as existing are not guaranteed. Before beginning work, investigate and verify the existence and location of mechanical and electrical systems, and other construction affecting the Work.
 - 1. Before construction, verify the location and invert elevation at points of connection of sanitary sewer and water-service piping and other utilities.
- B. Examination and Acceptance of Conditions: Before proceeding with each component of the Work, examine substrates, areas, and conditions, with Installer or Applicator present where indicated, for compliance with requirements for installation tolerances and other conditions affecting performance. Record observations.
 - 1. Examine roughing-in for mechanical and electrical systems to verify actual locations of connections before equipment and fixture installation.
 - 2. Examine walls, floors, and roofs for suitable conditions where products and systems are to be installed.
 - 3. Verify compatibility with and suitability of substrates, including compatibility with existing finishes or primers.
- C. Proceed with installation only after unsatisfactory conditions have been corrected. Proceeding with the Work indicates acceptance of surfaces and conditions.

3.2 PREPARATION

- A. Field Measurements: Take field measurements as required to fit the Work properly. Recheck measurements before installing each product. Where portions of the Work are indicated to fit to other construction, verify dimensions of other construction by field measurements before fabrication. Coordinate fabrication schedule with construction progress to avoid delaying the Work. Where construction schedule does not allow field measurement prior to fabrication layout work according to coordination drawings allowing tolerances needed to assure proper fit of Work.
- B. Space Requirements: Verify space requirements and dimensions of items shown diagrammatically on Drawings.
- C. Review of Contract Documents and Field Conditions: Immediately on discovery of the need for clarification of the Contract Documents caused by differing field conditions outside the control of Contractor, submit a request for information to Architect according to requirements in Section 013100 "Project Management and Coordination."

SECTION 017300 - EXECUTION

3.3 INSTALLATION

- A. General: Locate the Work and components of the Work accurately, in correct alignment and elevation, as indicated.
 - 1. Make vertical work plumb and make horizontal work level.
 - 2. Where space is limited, install components to maximize space available for maintenance and ease of removal for replacement.
 - 3. Conceal pipes, ducts, conduit and wiring in finished areas unless otherwise indicated.
- B. Comply with manufacturer's written instructions and recommendations for installing products in applications indicated.
- C. Install products at the time and under conditions that will ensure the best possible results. Maintain conditions required for product performance until Substantial Completion.
- D. Conduct construction operations so no part of the Work is subjected to damaging operations or loading in excess of that expected during normal conditions of occupancy.
- E. Sequence the Work and allow adequate clearances to accommodate movement of construction items on site and placement in permanent locations.
- F. Tools and Equipment: Do not use tools or equipment that produce harmful noise levels.
- G. Templates: Obtain and distribute to the parties involved templates for work specified to be factory prepared and field installed. Check Shop Drawings of other work to confirm that adequate provisions are made for locating and installing products to comply with indicated requirements.
- H. Attachment: Provide blocking and attachment plates and anchors and fasteners of adequate size and number to securely anchor each component in place, accurately located and aligned with other portions of the Work. Where size and type of attachments are not indicated, verify size and type required for load conditions.
 - 1. Mounting Heights: Where mounting heights are not indicated, mount components at heights directed by Architect.
 - 2. Allow for building movement, including thermal expansion and contraction.
 - 3. Coordinate installation of anchorages. Furnish setting drawings, templates, and directions for installing anchorages, including sleeves, concrete inserts, anchor bolts, and items with integral anchors, that are to be embedded in concrete or masonry. Deliver such items to Project site in time for installation.
- I. Joints: Make joints of uniform width. Where joint locations in exposed work are not indicated, arrange joints for the best visual effect. Fit exposed connections together to form hairline joints.
- J. Hazardous Materials: Use products, cleaners, and installation materials that are not considered hazardous.

SECTION 017300 - EXECUTION

3.4 CUTTING AND PATCHING

- A. Cutting and Patching, General: Employ skilled workers to perform cutting and patching. Proceed with cutting and patching at the earliest feasible time, and complete without delay.
 - 1. Cut in-place construction to provide for installation of other components or performance of other construction, and subsequently patch as required to restore surfaces to their original condition.
- B. Temporary Support: Provide temporary support of work to be cut.
- C. Protection: Protect in-place construction during cutting and patching to prevent damage. Provide protection from adverse weather conditions for portions of Project that might be exposed during cutting and patching operations.
- D. Adjacent Occupied Areas: Where interference with use of adjoining areas or interruption of free passage to adjoining areas is unavoidable, coordinate cutting and patching according to requirements in Section 011000 "Summary."
- E. Existing Utility Services and Mechanical/Electrical Systems: Where existing services/systems are required to be removed, relocated, or abandoned, bypass such services/systems before cutting to minimize interruption to occupied areas.
- F. Cutting: Cut in-place construction by sawing, drilling, breaking, chipping, grinding, and similar operations, including excavation, using methods least likely to damage elements retained or adjoining construction. If possible, review proposed procedures with original Installer; comply with original Installer's written recommendations.
 - 1. In general, use hand or small power tools designed for sawing and grinding, not hammering and chopping. Cut holes and slots neatly to minimum size required, and with minimum disturbance of adjacent surfaces. Temporarily cover openings when not in use.
 - 2. Finished Surfaces: Cut or drill from the exposed or finished side into concealed surfaces.
 - 3. Concrete: Cut using a cutting machine, such as an abrasive saw or a diamond-core drill.
 - 4. Excavating and Backfilling: Comply with requirements in applicable Sections where required by cutting and patching operations.
 - 5. Mechanical and Electrical Services: Cut off pipe or conduit in walls or partitions to be removed. Cap, valve, or plug and seal remaining portion of pipe or conduit to prevent entrance of moisture or other foreign matter after cutting.
 - 6. Proceed with patching after construction operations requiring cutting are complete.
- G. Patching: Patch construction by filling, repairing, refinishing, closing up, and similar operations following performance of other work. Patch with durable seams that are as invisible as practicable. Provide materials and comply with installation requirements specified in other Sections, where applicable.
 - 1. Inspection: Where feasible, test and inspect patched areas after completion to demonstrate physical integrity of installation.
 - 2. Exposed Finishes: Restore exposed finishes of patched areas and extend finish restoration into retained adjoining construction in a manner that will minimize evidence of patching and refinishing.

SECTION 017300 - EXECUTION

- a. Clean piping, conduit, and similar features before applying paint or other finishing materials.
 - b. Restore damaged pipe covering to its original condition.
3. Floors and Walls: Where walls or partitions that are removed extend one finished area into another, patch and repair floor and wall surfaces in the new space. Provide an even surface of uniform finish, color, texture, and appearance. Remove in-place floor and wall coverings and replace with new materials, if necessary, to achieve uniform color and appearance.
- a. Where patching occurs in a painted surface, prepare substrate and apply primer and intermediate paint coats appropriate for substrate over the patch, and apply final paint coat over entire unbroken surface containing the patch. Provide additional coats until patch blends with adjacent surfaces.
4. Ceilings: Patch, repair, or rehang in-place ceilings as necessary to provide an even-plane surface of uniform appearance.
5. Exterior Building Enclosure: Patch components in a manner that restores enclosure to a weather tight condition and ensures thermal and moisture integrity of building enclosure.
- H. Cleaning: Clean areas and spaces where cutting and patching are performed. Remove paint, mortar, oils, putty, and similar materials from adjacent finished surfaces.

3.5 PROGRESS CLEANING

- A. General: Clean Project site and work areas daily, including common areas. Enforce requirements strictly. Dispose of materials lawfully.
1. Comply with requirements in NFPA 241 for removal of combustible waste materials and debris.
 2. Do not hold waste materials more than seven days during normal weather or three days if the temperature is expected to rise above 80 deg F (27 deg C).
 3. Containerize hazardous and unsanitary waste materials separately from other waste. Mark containers appropriately and dispose of legally, according to regulations.
 - a. Use containers intended for holding waste materials of type to be stored.
 4. Coordinate progress cleaning for joint-use areas where Contractor and other contractors are working concurrently.
- B. Site: Maintain Project site free of waste materials and debris.
- C. Work Areas: Clean areas where work is in progress to the level of cleanliness necessary for proper execution of the Work.
1. Remove liquid spills promptly.
 2. Where dust would impair proper execution of the Work, broom-clean or vacuum the entire work area, as appropriate.

SECTION 017300 - EXECUTION

- D. **Installed Work:** Keep installed work clean. Clean installed surfaces according to written instructions of manufacturer or fabricator of product installed, using only cleaning materials specifically recommended. If specific cleaning materials are not recommended, use cleaning materials that are not hazardous to health or property and that will not damage exposed surfaces.
- E. **Concealed Spaces:** Remove debris from concealed spaces before enclosing the space.
- F. **Exposed Surfaces in Finished Areas:** Clean exposed surfaces and protect as necessary to ensure freedom from damage and deterioration at time of Substantial Completion.
- G. **Waste Disposal:** Do not bury or burn waste materials on-site. Do not wash waste materials down sewers or into waterways. Comply with waste disposal requirements in Section 015000 "Temporary Facilities and Controls."
- H. **During handling and installation,** clean and protect construction in progress and adjoining materials already in place. Apply protective covering where required to ensure protection from damage or deterioration at Substantial Completion.
- I. **Clean and provide maintenance on completed construction** as frequently as necessary through the remainder of the construction period. Adjust and lubricate operable components to ensure operability without damaging effects.
- J. **Limiting Exposures:** Supervise construction operations to assure that no part of the construction, completed or in progress, is subject to harmful, dangerous, damaging, or otherwise deleterious exposure during the construction period.

3.6 PROTECTION OF INSTALLED CONSTRUCTION

- A. **Provide final protection and maintain conditions that ensure installed Work is without damage or deterioration at time of Substantial Completion.**
- B. **Provide protection and maintain conditions that ensure existing finishes are without damage or deterioration at time of Substantial Completion.**
- C. **Comply with manufacturer's written instructions for temperature and relative humidity.**

END OF SECTION

SECTION 017700 - CLOSEOUT PROCEDURES

PART 1 - GENERAL

1.1 RELATED DOCUMENTS

- A. Drawings and general provisions of the Contract, including General and Supplementary Conditions and other Division 01 Specification Sections, apply to this Section.

1.2 SUMMARY

- A. Section includes administrative and procedural requirements for contract closeout, including, but not limited to, the following:
 - 1. Substantial Completion procedures.
 - 2. Final completion procedures.
 - 3. Warranties.
 - 4. Final cleaning.
 - 5. Repair of the Work.
- B. Related Requirements:
 - 1. Section 017300 "Execution" for progress cleaning of Project site.
 - 2. Section 017823 "Operation and Maintenance Data" for operation and maintenance manual requirements.

1.3 ACTION SUBMITTALS

- A. Product Data: For cleaning agents.
- B. Contractor's List of Incomplete Items: Initial submittal at Substantial Completion.
- C. Certified List of Incomplete Items: Final submittal at Final Completion.

1.4 FINAL ACCEPTANCE

- A. Before requesting inspection for certification of final acceptance and final payment, complete and submit the following:
 - 1. Submit final payment request.
 - 2. Submit a final Change Order request.
 - 3. Submit a copy of the final inspection list stating that each item has been completed or otherwise resolved for acceptance.
 - 4. Submit final meter readings for utilities, a record of stored fuel, and similar data as of Substantial Completion.
 - 5. Submit consent of surety to final payment.
 - 6. Submit evidence of continuing insurance coverage complying with insurance requirements.

SECTION 017700 - CLOSEOUT PROCEDURES

7. Written guarantees where required.
8. Maintenance stock items; spare parts; special tools, where required.
9. Certificates of final inspection and acceptance by local governing agencies having jurisdiction.
10. Completed CBJ Certificate of Compliance and Release form attached with this section.
11. Final Subcontractor list complete with final subcontract amounts and include all equipment rentals (with operators).
12. Alaska Department of Revenue Corporate Income Tax Clearance letter for the CONTRACTOR.
13. Before final payment can be made, the CONTRACTOR shall supply a copy of the "Notice of Completion of Public Works" form approved by Wage and Hour Administration of the Labor Standards and Safety Division of the Alaska Department of Labor and Workforce Development.
14. Alaska Department of Labor Employment Security Tax Clearance letter for the CONTRACTOR and all Subcontractors, a copy of which is located at the end of Section 00800 – Supplementary General Conditions.
15. Submit original items 11, 12, 13 and 14 to Contracts Administrator, CBJ Engineering.

1.5 SUBSTANTIAL COMPLETION PROCEDURES

- A. Contractor's List of Incomplete Items: Prepare and submit a list of items to be completed and corrected (Contractor's punch list), indicating all Work that is incomplete.
- B. Submittals Prior to Substantial Completion: Complete the following a minimum of 5 days prior to requesting inspection for determining date of Substantial Completion. List items below that are incomplete at time of request.
 1. Certificates of Release: Obtain and submit releases from authorities having jurisdiction permitting Owner unrestricted use of the Work and access to services and utilities. Include occupancy permits, operating certificates, and similar releases.
 2. Submit closeout submittals specified in other Division 01 Sections, including project record documents, operation and maintenance manuals, final completion construction photographic documentation, damage or settlement surveys, property surveys, and similar final record information for each phase.
 3. Submit closeout submittals specified in individual Sections, including specific warranties, workmanship bonds, maintenance service agreements, final certifications, and similar documents.
 4. Submit maintenance material submittals specified in individual Sections, including tools, spare parts, extra materials, and similar items, and deliver to location designated by Owner's Representative. Label with manufacturer's name and model number where applicable.
 5. Submit test/adjust/balance records.
 6. Submit changeover information related to Owner's occupancy, use, operation, and maintenance.
- C. Procedures Prior to Substantial Completion: Complete the following a minimum of 5 days prior to requesting inspection for determining date of Substantial Completion. List items below that are incomplete at time of request.
 1. Advise Owner of pending insurance changeover requirements.

SECTION 017700 - CLOSEOUT PROCEDURES

2. Make final changeover of permanent locks and deliver keys to Owner. Advise Owner's personnel of changeover in security provisions.
3. Complete startup and testing of systems and equipment.
4. Perform preventive maintenance on equipment used prior to Substantial Completion.
5. Terminate and remove temporary facilities from Project site, along with mockups, construction tools, and similar elements.
6. Complete final cleaning requirements, including touchup painting.
7. Touch up and otherwise repair and restore marred exposed finishes to eliminate visual defects.

D. Inspection: Submit a written request for inspection to determine Substantial Completion a minimum of 5 days prior to date the work will be completed and ready for final inspection and tests. On receipt of request, Architect and Owner's Representative will either proceed with inspection or notify Contractor of unfulfilled requirements. Architect will prepare the Certificate of Substantial Completion after inspection or will notify Contractor of items, either on Contractor's list or additional items identified by Architect, that must be completed or corrected before certificate will be issued.

1. Reinspection: Request reinspection when the Work identified in previous inspections as incomplete is completed or corrected.
2. Results of completed inspection will form the basis of requirements for final completion.

1.6 FINAL COMPLETION PROCEDURES

A. Submittals Prior to Final Completion: Before requesting final inspection for determining final completion, complete items listed in 1.4 FINAL ACCEPTANCE:

B. Inspection: Submit a written request for final inspection to determine acceptance a minimum of 10 days prior to date the work will be completed and ready for final inspection and tests. On receipt of request, Architect and Owner's Representative will either proceed with inspection or notify Contractor of unfulfilled requirements. Architect will prepare a final Certificate for Payment after inspection or will notify Contractor of construction that must be completed or corrected before certificate will be issued.

1. Reinspection: Request reinspection when the Work identified in previous inspections as incomplete is completed or corrected.

1.7 LIST OF INCOMPLETE ITEMS (PUNCH LIST)

A. Organization of List: Include name and identification of each space and area affected by construction operations for incomplete items and items needing correction including, if necessary, areas disturbed by Contractor that are outside the limits of construction.

1. Organize list of spaces in sequential order, starting with exterior areas first and proceeding from lowest floor to highest floor.
2. Organize items applying to each space by major element, including categories for ceiling, individual walls, floors, equipment, and building systems.
3. Include the following information at the top of each page:

SECTION 017700 - CLOSEOUT PROCEDURES

- a. Project name.
 - b. Date.
 - c. Name of Architect.
 - d. Name of Contractor.
 - e. Page number.
4. Submit list of incomplete items in the following format:
- a. PDF electronic file. Architect through Owner's Representative will return annotated file.

1.8 SUBMITTAL OF PROJECT WARRANTIES

- A. Time of Submittal: Submit written warranties on request of Architect for designated portions of the Work where commencement of warranties other than date of Substantial Completion is indicated, or when delay in submittal of warranties might limit Owner's rights under warranty.
- B. Partial Occupancy: Submit properly executed warranties within 15 days of completion of designated portions of the Work that are completed and occupied or used by Owner during construction period by separate agreement with Contractor.
- C. Organize warranty documents into an orderly sequence based on the table of contents of Project Manual.
 1. Bind warranties and bonds in heavy-duty, three-ring, vinyl-covered, loose-leaf binders, thickness as necessary to accommodate contents, and sized to receive 8-1/2-by-11-inch (215-by-280-mm) paper.
 2. Provide heavy paper dividers with plastic-covered tabs for each separate warranty. Mark tab to identify the product or installation. Provide a typed description of the product or installation, including the name of the product and the name, address, and telephone number of Installer.
 3. Identify each binder on the front and spine with the typed or printed title "WARRANTIES," Project name, and name of Contractor.
 4. Provide electronic PDF copy of all warranty documents.
- D. Provide additional copies and scans of each warranty to include in operation and maintenance manuals.

PART 2 - PRODUCTS

2.1 MATERIALS

- A. Cleaning Agents: Use cleaning materials and agents recommended by manufacturer or fabricator of the surface to be cleaned. Do not use cleaning agents that are potentially hazardous to health or property or that might damage finished surfaces.

SECTION 017700 - CLOSEOUT PROCEDURES

1. Use cleaning products that comply with Green Seal's GS-37, or if GS-37 is not applicable, use products that comply with the California Code of Regulations maximum allowable VOC levels.

PART 3 - EXECUTION

3.1 FINAL CLEANING

- A. General: Perform final cleaning. Conduct cleaning and waste-removal operations to comply with local laws and ordinances and Federal and local environmental and antipollution regulations.
- B. Cleaning: Employ experienced workers or professional cleaners for final cleaning. Clean each surface or unit to condition expected in an average commercial building cleaning and maintenance program. Comply with manufacturer's written instructions.
 1. Complete the following cleaning operations before requesting inspection for certification of Substantial Completion for entire Project or for a designated portion of Project:
 - a. Clean Project site, yard, and grounds, in areas disturbed by construction activities, including landscape development areas, of rubbish, waste material, litter, and other foreign substances.
 - b. Sweep paved areas broom clean. Remove petrochemical spills, stains, and other foreign deposits.
 - c. Rake grounds that are neither planted nor paved to a smooth, even-textured surface.
 - d. Remove tools, construction equipment, machinery, and surplus material from Project site.
 - e. Clean exposed exterior and interior hard-surfaced finishes to a dirt-free condition, free of stains, films, and similar foreign substances. Avoid disturbing natural weathering of exterior surfaces. Restore reflective surfaces to their original condition.
 - f. Remove debris and surface dust from limited access spaces, including roofs, plenums, shafts, trenches, equipment vaults, manholes, attics, and similar spaces.
 - g. Sweep concrete floors broom clean in unoccupied spaces.
 - h. Vacuum carpet and similar soft surfaces, removing debris and excess nap; clean according to manufacturer's recommendations if visible soil or stains remain.
 - i. Clean transparent materials, including mirrors and glass in doors and windows. Remove glazing compounds and other noticeable, vision-obscuring materials. Polish mirrors and glass, taking care not to scratch surfaces.
 - j. Remove labels that are not permanent.
 - k. Wipe surfaces of mechanical and electrical equipment, elevator equipment, and similar equipment. Remove excess lubrication, paint and mortar droppings, and other foreign substances.
 - l. Clean plumbing fixtures to a sanitary condition, free of stains, including stains resulting from water exposure.
 - m. Replace disposable air filters and clean permanent air filters. Clean exposed surfaces of diffusers, registers, and grills.

SECTION 017700 - CLOSEOUT PROCEDURES

- n. Clean ducts, blowers, and coils if units were operated without filters during construction or that display contamination with particulate matter on inspection.
 - 1) Clean HVAC system in compliance with NADCA Standard 1992-01. Provide written report on completion of cleaning.
 - o. Clean light fixtures, lamps, globes, and reflectors to function with full efficiency.
 - p. Leave Project clean and ready for occupancy.
- C. Construction Waste Disposal: Comply with waste disposal requirements in Section 015000 "Temporary Facilities and Controls."

3.2 REPAIR OF THE WORK

- A. Complete repair and restoration operations before requesting inspection for determination of Substantial Completion.
- B. Repair or remove and replace defective construction. Repairing includes replacing defective parts, refinishing damaged surfaces, touching up with matching materials, and properly adjusting operating equipment. Where damaged or worn items cannot be repaired or restored, provide replacements. Remove and replace operating components that cannot be repaired. Restore damaged construction and permanent facilities used during construction to specified condition.
 - 1. Remove and replace chipped, scratched, and broken glass, reflective surfaces, and other damaged transparent materials.
 - 2. Touch up and otherwise repair and restore marred or exposed finishes and surfaces. Replace finishes and surfaces that already show evidence of repair or restoration.
 - a. Do not paint over "UL" and other required labels and identification, including mechanical and electrical nameplates. Remove paint applied to required labels and identification.
 - 3. Replace parts subject to operating conditions during construction that may impede operation or reduce longevity.
 - 4. Replace burned-out bulbs, bulbs noticeably dimmed by hours of use, and defective and noisy starters in fluorescent and mercury vapor fixtures to comply with requirements for new fixtures.

SECTION 017700 - CLOSEOUT PROCEDURES

COMPLIANCE CERTIFICATE AND RELEASE FORM

PROJECT: CBJ Douglas Library Meeting Room Renovation
CONTRACT NO: BE20-259

The **CONTRACTOR** must complete and submit this form to the Contract Administrator with respect to the entire contract and submit completed Subcontractor Compliance forms for each Subcontractor used on the Contract and listed on the Subcontractor report.

Completed forms shall be submitted upon completion of the Project. All requirements and submittals must be met before final payment will be made to the **CONTRACTOR**.

I certify that the following and any referenced attachments are true:

- All WORK has been performed, materials supplied, and requirements met in accordance with the applicable Drawings, Specifications, and Contract Documents.
- All payments to Subcontractors and Suppliers have been made in accordance with Alaska Statute 36.90.210. If not, please provide written explanation, for each case, why and the specific mutual payment agreement reached with the Supplier or Subcontractor.
- CHECK ONE:
 - All Suppliers and Subcontractors have been paid in full with no claims for labor, materials or other services outstanding.
 - The following Suppliers and Subcontractors are due final payment which will be made upon the release of the final payment by the CBJ. List the Suppliers and Subcontractors and the amount they are due below (attach separate sheet if necessary) :

	Supplier or Subcontractor	Amount Owed
1.		\$
2.		\$
3.		\$
4.		\$
5.		\$
6.		\$
7.		\$

SECTION 017700 - CLOSEOUT PROCEDURES

- All employees have been paid not less than the current prevailing wage rates set by the State of Alaska (or U.S. Department of Labor, as applicable).
- All equal employment opportunity, certified payroll and other reports have been filed in accordance with the prime contract.
- The attached list of Subcontractors is complete (required from CONTRACTOR). The City Engineer was advised and approved of all Subcontractors before WORK was performed and has approved any substitutions of Subcontractors.
- All DBE firms listed as a precondition of the prime contract award must have performed a commercially useful function in order for the WORK to count to a DBE goal. All DBE firms performed the WORK stated and have received at least the amount claimed for credit in the Contract Documents.
- All DBE Subcontractors must attach a signed statement of the payment amount received, the nature of WORK performed, whether any balance is outstanding, and indicate that no rebates are involved.
- If the amount paid is less than the amount originally claimed for DBE credit, the CONTRACTOR has attached approval from the City Engineer for underutilization.

I understand it is unlawful to misrepresent information in order to receive a payment which would otherwise be withheld if these conditions were not met. I am an authorized agent of this firm and sign this freely and voluntarily. The foregoing statements are true and apply to the following project contractor.

_____ Capacity: CONTRACTOR
Firm Name

Signature

Printed Name and Title

Date

Return completed form to: Engineering Contracts Division, City and Borough of Juneau, 155 South Seward Street, Juneau, AK 99801 or by email to: contracts@juneau.org

Call (907) 586-0873 if we can be of further assistance or if you have any questions.

SECTION 017700 - CLOSEOUT PROCEDURES

SUBCONTRACTOR COMPLIANCE CERTIFICATE AND RELEASE FORM

PROJECT: CBJ Douglas Library Meeting Room Renovation
CONTRACT NO: BE20-259

Each **SUBCONTRACTOR** must complete and submit this form to the Contract Administrator, through the General Contractor, with respect to the entire contract.

Completed forms shall be submitted upon completion of the Project. All requirements and submittals must be met before final payment will be made to the **CONTRACTOR**.

I certify that the following and any referenced attachments are true:

- All **WORK** has been performed, materials supplied, and requirements met in accordance with the applicable Drawings, Specifications, and Contract Documents.
- _____(name of firm) has been paid by the Contractor in accordance with Alaska Statute 36.90.210. (If not, please provide written explanation on an attached sheet, for each case. Provide specific details why payment was not made and the specific mutual payment agreement reached with the Contractor if it is still unresolved.)
- **CHECK ONE:**
 - I / WE have been paid in full by the Contractor, with no claims for labor, materials or other services outstanding.
 - I / WE are due the following amount from the Contractor which is included in the Contractors Request for Final Payment. WE are due a total of \$ _____ for the following individual items that have yet to be paid (attach separate sheet if necessary).

	Outstanding Payment Item	Outstanding Amount Owed
1.		\$
2.		\$
3.		\$
4.		\$
5.		\$
6.		\$
7.		\$

SECTION 017700 - CLOSEOUT PROCEDURES

- All employees have been paid not less than the current prevailing wage rates set by the State of Alaska (or U.S. Department of Labor, as applicable).
- All equal employment opportunity, certified payroll and other reports have been filed in accordance with the prime contract.

I understand it is unlawful to misrepresent information in order to receive a payment which would otherwise be withheld if these conditions were not met. I am an authorized agent of this firm and sign this freely and voluntarily. The foregoing statements are true and apply to the following project contractor.

Firm Name Capacity: SUBCONTRACTOR

Signature Printed Name and Title _____
Date

Prime Contractor shall return completed form to: Engineering Contracts Division, City and Borough of Juneau, 155 South Seward Street, Juneau, AK 99801 or email: greg.smith@juneau.org Call (907) 586-0873 if we can be of further assistance or if you have any questions.

END OF SECTION

SECTION 017823 - OPERATION AND MAINTENANCE DATA

PART 1 - GENERAL

1.1 RELATED DOCUMENTS

- A. Drawings and general provisions of the Contract, including General and Supplementary Conditions and other Division 01 Specification Sections, apply to this Section.

1.2 SUMMARY

- A. Section includes administrative and procedural requirements for preparing operation and maintenance manuals, including the following:
 - 1. Operation and maintenance documentation directory.
 - 2. Operation manuals for systems, subsystems, and equipment.
 - 3. Product maintenance manuals.
- B. Related Requirements:
 - 1. Section 013300 "Submittal Procedures" for submitting copies of submittals for operation and maintenance manuals.

1.3 DEFINITIONS

- A. System: An organized collection of parts, equipment, or subsystems united by regular interaction.
- B. Subsystem: A portion of a system with characteristics similar to a system.

1.4 CLOSEOUT SUBMITTALS

- A. Manual Content: Operations and maintenance manual for each item specified in individual Specification Sections. Submit operations and maintenance manual content formatted and organized as required by this Section.
- B. Format: Submit operations and maintenance manuals in both of the following formats:
 - 1. Adobe Acrobat .PDF electronic file. Assemble each manual into a composite electronically indexed file. Submit on digital media acceptable to Architect. Provide review submittals in PDF format and final corrected submittal in PDF format.
 - a. Name each indexed document file in composite electronic index with applicable item name. Include a complete electronically linked operation and maintenance directory.
 - b. Enable inserted reviewer comments on draft submittals.

SECTION 017823 - OPERATION AND MAINTENANCE DATA

2. Two paper copies. Include a complete operation and maintenance directory. Enclose title pages and directories in clear plastic sleeves. Provide paper copies for final submittal only.
- C. Initial Manual Submittal: Submit draft copy of each manual at least 15 days before commencing demonstration and training. Architect and Commissioning Agent will comment on whether general scope and content of manual are acceptable.
- D. Final Manual Submittal: Submit each manual in final form prior to requesting inspection for Final Completion and at least 10 days before commencing demonstration and training. Architect and Commissioning Agent will return copy with comments.
1. Correct or revise each manual to comply with Architect's and Commissioning Authority's comments. Submit copies of each corrected manual within 10 days of receipt of Architect's and Commissioning Agent's comments and prior to commencing demonstration and training.

PART 2 - PRODUCTS

2.1 OPERATION AND MAINTENANCE DOCUMENTATION DIRECTORY

- A. Directory: Prepare a single, comprehensive directory of emergency, operation, and maintenance data and materials, listing items and their location to facilitate ready access to desired information. Include a section in the directory for each of the following:
1. List of documents.
 2. List of systems.
 3. List of equipment.
 4. Table of contents.
- B. List of Systems and Subsystems: List systems alphabetically. Include references to operation and maintenance manuals that contain information about each system.
- C. List of Equipment: List equipment for each system, organized alphabetically by system. For pieces of equipment not part of system, list alphabetically in separate list.
- D. Tables of Contents: Include a table of contents for each emergency, operation, and maintenance manual.
- E. Identification: In the documentation directory and in each operation and maintenance manual, identify each system, subsystem, and piece of equipment with same designation used in the Contract Documents. If no designation exists, assign a designation according to ASHRAE Guideline 4, "Preparation of Operating and Maintenance Documentation for Building Systems."

SECTION 017823 - OPERATION AND MAINTENANCE DATA

2.2 REQUIREMENTS FOR OPERATION, AND PRODUCT MAINTENANCE MANUALS

- A. Organization: Unless otherwise indicated, organize each manual into a separate section for each system and subsystem, and a separate section for each piece of equipment not part of a system. Each manual shall contain the following materials, in the order listed:
1. Title page.
 2. Table of contents.
 3. Manual contents.
- B. Title Page: Include the following information:
1. Subject matter included in manual.
 2. Name and address of Project.
 3. Name and address of Owner.
 4. Date of submittal.
 5. Name and contact information for Contractor.
 6. Name and contact information for Construction Manager.
 7. Name and contact information for Architect.
 8. Name and contact information for Commissioning Authority.
 9. Names and contact information for major consultants to the Architect that designed the systems contained in the manuals.
 10. Cross-reference to related systems in other operation and maintenance manuals.
- C. Table of Contents: List each product included in manual, identified by product name, indexed to the content of the volume, and cross-referenced to Specification Section number in Project Manual.
1. If operation or maintenance documentation requires more than one volume to accommodate data, include comprehensive table of contents for all volumes in each volume of the set.
- D. Manual Contents: Organize into sets of manageable size. Arrange contents alphabetically by system, subsystem, and equipment. If possible, assemble instructions for subsystems, equipment, and components of one system into a single binder.
- E. Manuals, Electronic Files: Submit manuals in the form of a multiple file composite electronic PDF file for each manual type required.
1. Electronic Files: Use electronic files prepared by manufacturer where available. Where scanning of paper documents is required, configure scanned file for minimum readable file size.
 2. File Names and Bookmarks: Enable bookmarking of individual documents based on file names. Name document files to correspond to system, subsystem, and equipment names used in manual directory and table of contents. Group documents for each system and subsystem into individual composite bookmarked files, then create composite manual, so that resulting bookmarks reflect the system, subsystem, and equipment names in a readily navigated file tree. Configure electronic manual to display bookmark panel on opening file.
- F. Manuals, Paper Copy: Submit manuals in the form of hard copy, bound and labeled volumes.

SECTION 017823 - OPERATION AND MAINTENANCE DATA

1. Binders: Heavy-duty, three-ring, vinyl-covered, loose-leaf binders, in thickness necessary to accommodate contents, sized to hold 8-1/2-by-11-inch paper; with clear plastic sleeve on spine to hold label describing contents and with pockets inside covers to hold folded oversize sheets.
 - a. If two or more binders are necessary to accommodate data of a system, organize data in each binder into groupings by subsystem and related components. Cross-reference other binders if necessary to provide essential information for proper operation or maintenance of equipment or system.
 - b. Identify each binder on front and spine, with printed title "OPERATION AND MAINTENANCE MANUAL," Project title or name, and subject matter of contents. Indicate volume number for multiple-volume sets.
2. Dividers: Heavy-paper dividers with plastic-covered tabs for each section of the manual. Mark each tab to indicate contents. Include typed list of products and major components of equipment included in the section on each divider, cross-referenced to Specification Section number and title of Project Manual.
3. Protective Plastic Sleeves: Transparent plastic sleeves designed to enclose diagnostic software storage media for computerized electronic equipment.
4. Supplementary Text: Prepared on 8-1/2-by-11-inch white bond paper.
5. Drawings: Attach reinforced, punched binder tabs on drawings and bind with text.
 - a. If oversize drawings are necessary, fold drawings to same size as text pages and use as foldouts.
 - b. If drawings are too large to be used as foldouts, fold and place drawings in labeled envelopes and bind envelopes in rear of manual. At appropriate locations in manual, insert typewritten pages indicating drawing titles, descriptions of contents, and drawing locations.

2.3 PRODUCT MAINTENANCE MANUALS

- A. Content: Organize manual into a separate section for each product, material, and finish. Include source information, product information, maintenance procedures, repair materials and sources, and warranties and bonds, as described below.
- B. Source Information: List each product included in manual, identified by product name and arranged to match manual's table of contents. For each product, list name, address, and telephone number of Installer or supplier and maintenance service agent, and cross-reference Specification Section number and title in Project Manual and drawing or schedule designation or identifier where applicable.
- C. Product Information: Include the following, as applicable:
 1. Product name and model number.
 2. Manufacturer's name.
 3. Color, pattern, and texture.
 4. Material and chemical composition.
 5. Reordering information for specially manufactured products.
- D. Maintenance Procedures: Include manufacturer's written recommendations and the following:

SECTION 017823 - OPERATION AND MAINTENANCE DATA

1. Inspection procedures.
 2. Types of cleaning agents to be used and methods of cleaning.
 3. List of cleaning agents and methods of cleaning detrimental to product.
 4. Schedule for routine cleaning and maintenance.
 5. Repair instructions.
- E. Repair Materials and Sources: Include lists of materials and local sources of materials and related services.
- F. Warranties and Bonds: Include copies of warranties and bonds and lists of circumstances and conditions that would affect validity of warranties or bonds.
1. Include procedures to follow and required notifications for warranty claims.

PART 3 - EXECUTION

3.1 MANUAL PREPARATION

- A. Product Maintenance Manual: Assemble a complete set of maintenance data indicating care and maintenance of each product, material, and finish incorporated into the Work.
- B. Manufacturers' Data: Where manuals contain manufacturers' standard printed data, include only sheets pertinent to product or component installed. Mark each sheet to identify each product or component incorporated into the Work. If data include more than one item in a tabular format, identify each item using appropriate references from the Contract Documents. Identify data applicable to the Work and delete references to information not applicable.
1. Prepare supplementary text if manufacturers' standard printed data are not available and where the information is necessary for proper operation and maintenance of equipment or systems.
- C. Drawings: Prepare drawings supplementing manufacturers' printed data to illustrate the relationship of component parts of equipment and systems and to illustrate control sequence and flow diagrams. Coordinate these drawings with information contained in record Drawings to ensure correct illustration of completed installation.
1. Do not use original project record documents as part of operation and maintenance manuals.
 2. Comply with requirements of newly prepared record Drawings in Section 017839 "Project Record Documents."
- D. Comply with Section 017700 "Closeout Procedures" for schedule for submitting operation and maintenance documentation.

END OF SECTION

SECTION 017839 - PROJECT RECORD DOCUMENTS

PART 1 - GENERAL

1.1 SUMMARY

- A. Section includes administrative and procedural requirements for project record documents, including the following:
 - 1. Record Drawings.
 - 2. Record Specifications.
 - 3. Record Product Data.
- B. Related Requirements:
 - 1. Section 017823 "Operation and Maintenance Data" for operation and maintenance manual requirements.

1.2 CLOSEOUT SUBMITTALS

- A. Record Drawings: Comply with the following:
 - 1. Number of Copies: Submit copies of record Drawings as follows:
 - a. Initial Submittal:
 - 1) Submit PDF electronic files of scanned marked-up record prints.
 - 2) Architect will review for completeness and accuracy.
 - b. Final Submittal:
 - 1) Submit one paper-copy set(s) of marked-up record prints.
 - 2) Submit PDF electronic files of scanned marked-up record prints.
- B. Record Specifications: Submit one paper copy of Project's Specifications, including addenda and contract modifications.
- C. Record Product Data: Submit one paper copy of each submittal.

PART 2 - PRODUCTS

2.1 RECORD DRAWINGS

- A. Record Prints: Maintain one set of marked-up paper copies of the Contract Drawings and Shop Drawings, incorporating new and revised Drawings as modifications are issued.
 - 1. Preparation: Mark record prints to show the actual installation where installation varies from that shown originally. Require individual or entity who obtained record data,

SECTION 017839 - PROJECT RECORD DOCUMENTS

whether individual or entity is Installer, subcontractor, or similar entity, to provide information for preparation of corresponding marked-up record prints.

- a. Give particular attention to information on concealed elements that would be difficult to identify or measure and record later.
 - b. Record data as soon as possible after obtaining it.
 - c. Record and check the markup before enclosing concealed installations.
2. Mark the Contract Drawings and Shop Drawings completely and accurately. Use personnel proficient at recording graphic information in production of marked-up record prints.
 3. Mark record sets with erasable, red-colored pencil. Use other colors to distinguish between changes for different categories of the Work at same location.
 4. Note Construction Change Directive numbers, alternate numbers, Change Order numbers, and similar identification, where applicable.
- B. Format: Identify and date each record Drawing; include the designation "PROJECT RECORD DRAWING" in a prominent location.
1. Record Prints: Organize record prints and newly prepared record Drawings into manageable sets. Bind each set with durable paper cover sheets. Include identification on cover sheets.
 2. Format: Annotated PDF electronic file with comment function enabled.
 3. Record Digital Data Files: Organize digital data information into separate electronic files that correspond to each sheet of the Contract Drawings. Name each file with the sheet identification. Include identification in each digital data file.
 4. Identification: As follows:
 - a. Project name.
 - b. Date.
 - c. Designation "PROJECT RECORD DRAWINGS."
 - d. Name of Architect.
 - e. Name of Contractor.

2.2 RECORD SPECIFICATIONS

- A. Preparation: Mark Specifications to indicate the actual product installation where installation varies from that indicated in Specifications, addenda, and contract modifications.
1. Give particular attention to information on concealed products and installations that cannot be readily identified and recorded later.
 2. Mark copy with the proprietary name and model number of products, materials, and equipment furnished, including substitutions and product options selected.
 3. Record the name of manufacturer, supplier, Installer, and other information necessary to provide a record of selections made.
 4. Note related Change Orders, record Product Data, and record Drawings where applicable.
- B. Format: Submit record Specifications as annotated PDF electronic file or paper copy.

SECTION 017839 - PROJECT RECORD DOCUMENTS

2.3 MISCELLANEOUS RECORD SUBMITTALS

- A. Assemble miscellaneous records required by other Specification Sections for miscellaneous record keeping and submittal in connection with actual performance of the Work. Bind or file miscellaneous records and identify each, ready for continued use and reference.
- B. Format: Submit miscellaneous record submittals as PDF electronic file & paper copy.

PART 3 - EXECUTION

3.1 RECORDING AND MAINTENANCE

- A. Recording: Maintain one copy of each submittal during the construction period for project record document purposes. Post changes and revisions to project record documents as they occur; do not wait until end of Project.
- B. Maintenance of Record Documents and Samples: Store record documents and Samples in the field office apart from the Contract Documents used for construction. Do not use project record documents for construction purposes. Maintain record documents in good order and in a clean, dry, legible condition, protected from deterioration and loss. Provide access to project record documents for Architect's reference during normal working hours.

END OF SECTION

SECTION 024119 – SELECTIVE DEMOLITION

SECTION 024119 - SELECTIVE DEMOLITION

PART 1 - GENERAL

1.1 RELATED DOCUMENTS

- A. Drawings and general provisions of the Contract, including General and Supplementary Conditions and Division 01 Specification Sections, apply to this Section.

1.2 SUMMARY

A. Section Includes:

1. Demolition and removal of selected portions of building or structure.
2. Salvage of existing items to be reused or recycled.

B. Related Requirements:

1. Section 011000 "Summary" for restrictions on use of the premises, Owner-occupancy requirements, and phasing requirements.

1.3 DEFINITIONS

- A. Remove: Detach items from existing construction and dispose of them off-site unless indicated to be salvaged or reinstalled.
- B. Remove and Salvage: Detach items from existing construction, in a manner to prevent damage, and store.
- C. Remove and Reinstall: Detach items from existing construction, in a manner to prevent damage, prepare for reuse, and reinstall where indicated.
- D. Existing to Remain: Leave existing items that are not to be removed and that are not otherwise indicated to be salvaged or reinstalled.

1.4 MATERIALS OWNERSHIP

- A. Unless otherwise indicated, demolition waste becomes property of Contractor.

1.5 FIELD CONDITIONS

- A. Owner will occupy portions of building immediately adjacent to selective demolition area. Conduct selective demolition so Owner's operations will not be disrupted.

SECTION 024119 – SELECTIVE DEMOLITION

- B. Conditions existing at time of inspection for bidding purpose will be maintained by Owner as far as practical.
 - 1. Before selective demolition, Owner will remove the following items:
 - a. Freestanding furniture.
- C. Notify Architect of discrepancies between existing conditions and Drawings before proceeding with selective demolition.
- D. Hazardous Materials: It is not expected that hazardous materials will be encountered in the Work.
 - 1. If suspected hazardous materials are encountered, do not disturb; immediately notify Architect and Owner. Hazardous materials will be removed by Owner under a separate contract.
- E. Utility Service: Maintain existing utilities indicated to remain in service and protect them against damage during selective demolition operations.
 - 1. Maintain fire-protection facilities in service during selective demolition operations.

1.6 WARRANTY

- A. Existing Warranties: Remove, replace, patch, and repair materials and surfaces cut or damaged during selective demolition, by methods and with materials and using approved contractors so as not to void existing warranties.

1.7 COORDINATION

- A. Arrange selective demolition schedule so as not to interfere with Owner's operations.

PART 2 - PRODUCTS

PART 3 - EXECUTION

3.1 EXAMINATION

- A. Verify that utilities have been disconnected and capped before starting selective demolition operations.
- B. Review Project Record Documents of existing construction or other existing condition and hazardous material information provided by Owner. Owner does not guarantee that existing conditions are same as those indicated in Project Record Documents.

SECTION 024119 – SELECTIVE DEMOLITION

3.2 UTILITY SERVICES AND MECHANICAL/ELECTRICAL SYSTEMS

- A. Existing Services/Systems to Remain: Maintain services/systems indicated to remain and protect them against damage.
- B. Existing Services/Systems to Be Removed, Relocated, or Abandoned: Locate, identify, disconnect, and seal or cap off utility services and mechanical/electrical systems serving areas to be selectively demolished.
 - 1. If services/systems are required to be removed, relocated, or abandoned, provide temporary services/systems that bypass area of selective demolition and that maintain continuity of services/systems to other parts of building.
 - 2. Disconnect, demolish, and remove fire-suppression systems, plumbing, and HVAC systems, equipment, and components indicated on Drawings to be removed.
 - a. Equipment to Be Removed: Disconnect and cap services and remove equipment.
 - b. Equipment to Be Removed and Reinstalled: Disconnect and cap services and remove, clean, and store equipment; when appropriate, reinstall, reconnect, and make equipment operational.
 - c. Equipment to Be Removed and Salvaged: Disconnect and cap services and remove equipment and deliver to Owner.

3.3 PROTECTION

- A. Temporary Protection: Provide temporary barricades and other protection required to prevent injury to people and damage to adjacent buildings and facilities to remain.
 - 1. Provide protection to ensure safe passage of people around selective demolition area and to and from occupied portions of building.
 - 2. Protect walls, ceilings, floors, and other existing finish work that are to remain or that are exposed during selective demolition operations.
 - 3. Cover and protect furniture, furnishings, and equipment that have not been removed.
- B. Remove temporary barricades and protections where hazards no longer exist.

3.4 SELECTIVE DEMOLITION, GENERAL

- A. General: Demolish and remove existing construction only to the extent required by new construction and as indicated. Use methods required to complete the Work within limitations of governing regulations and as follows:
 - 1. Proceed with selective demolition systematically, from higher to lower level. Complete selective demolition operations above each floor or tier before disturbing supporting members on the next lower level.
 - 2. Neatly cut openings and holes plumb, square, and true to dimensions required. Use cutting methods least likely to damage construction to remain or adjoining construction. Use hand tools or small power tools designed for sawing or grinding, not hammering and chopping. Temporarily cover openings to remain.

SECTION 024119 – SELECTIVE DEMOLITION

3. Cut or drill from the exposed or finished side into concealed surfaces to avoid marring existing finished surfaces.
4. Do not use cutting torches until work area is cleared of flammable materials. At concealed spaces, such as duct and pipe interiors, verify condition and contents of hidden space before starting flame-cutting operations. Maintain portable fire-suppression devices during flame-cutting operations.
5. Remove decayed, vermin-infested, or otherwise dangerous or unsuitable materials and promptly dispose of off-site.
6. Locate selective demolition equipment and remove debris and materials so as not to impose excessive loads on supporting walls, floors, or framing.
7. Dispose of demolished items and materials promptly.

B. Removed and Salvaged Items:

1. Clean salvaged items.
2. Pack or crate items after cleaning. Identify contents of containers.
3. Store items in a secure area until delivery to Owner.
4. Protect items from damage during transport and storage.

C. Removed and Reinstalled Items:

1. Clean and repair items to functional condition adequate for intended reuse.
2. Pack or crate items after cleaning and repairing. Identify contents of containers.
3. Protect items from damage during transport and storage.
4. Reinstall items in locations indicated. Comply with installation requirements for new materials and equipment. Provide connections, supports, and miscellaneous materials necessary to make item functional for use indicated.

D. Existing Items to Remain: Protect construction indicated to remain against damage and soiling during selective demolition. When permitted by Architect, items may be removed to a suitable, protected storage location during selective demolition and cleaned and reinstalled in their original locations after selective demolition operations are complete.

3.5 SELECTIVE DEMOLITION PROCEDURES FOR SPECIFIC MATERIALS

- A. Resilient Floor Coverings: Remove floor coverings and adhesive according to recommendations in RFCI's "Recommended Work Practices for the Removal of Resilient Floor Coverings." Do not use methods requiring solvent-based adhesive strippers.

3.6 DISPOSAL OF DEMOLISHED MATERIALS

- A. Remove demolition waste materials from Project site and dispose of them in an EPA-approved construction and demolition waste landfill acceptable to authorities having jurisdiction.
1. Do not allow demolished materials to accumulate on-site.
 2. Remove and transport debris in a manner that will prevent spillage on adjacent surfaces and areas.

SECTION 024119 – SELECTIVE DEMOLITION

3.7 CLEANING

- A. Clean adjacent structures and improvements of dust, dirt, and debris caused by selective demolition operations. Return adjacent areas to condition existing before selective demolition operations began.

END OF SECTION 024119

SECTION 064600 – WOOD TRIM

SECTION 064600 - WOOD TRIM

PART 1 - GENERAL

1.1 SUMMARY

- A. Section Includes:
 - 1. Interior standing and running trim.

1.2 ACTION SUBMITTALS

- A. Samples:
 - 1. Lumber for transparent finish, for each species and cut, finished on one side and one edge.

PART 2 - PRODUCTS

2.1 INTERIOR STANDING AND RUNNING TRIM FOR TRANSPARENT FINISH

- A. Grade: Custom.
- B. Wood Species and Cut: Match species and cut indicated for other types of transparent-finished architectural woodwork located in same area of building unless otherwise indicated.

2.2 FABRICATION

- A. Fabricate wood trim to dimensions, profiles, and details indicated. Ease edges to radius indicated for the following:
 - 1. Edges of Solid-Wood (Lumber) Members: 1/16 inch (1.5 mm) unless otherwise indicated.
- B. Backout or groove backs of flat trim members and kerf backs of other wide, flat members except for members with ends exposed in finished work.
- C. Assemble casings in shop except where shipping limitations require field assembly.

2.3 SHOP FINISHING

- A. General: Finish wood trim at fabrication shop as specified in this Section. Defer only final touchup, cleaning, and polishing until after installation.

SECTION 064600 – WOOD TRIM

- B. Preparation for Finishing: Comply with referenced quality standard for sanding, filling countersunk fasteners, sealing concealed surfaces, and similar preparations for finishing wood trim, as applicable to each unit of work.
- C. Transparent Finish for Interior Trim:
 - 1. Grade: Custom.
 - 2. Finish: System - 5, conversion varnish.
 - 3. Staining: None required.
 - 4. Open Finish for Open-Grain Woods: Do not apply filler to open-grain woods.
 - 5. Sheen: Satin, 31-45 gloss units measured on 60-degree gloss meter per ASTM D 523.

PART 3 - EXECUTION

3.1 PREPARATION

- A. Before installation, condition wood trim to average prevailing humidity conditions in installation areas.

3.2 INSTALLATION

- A. Grade: Install wood trim to comply with same grade as item to be installed.
- B. Install wood trim level, plumb, true, and straight. Shim as required with concealed shims. Install level and plumb to a tolerance of 1/8 inch in 96 inches (3 mm in 2400 mm).
- C. Scribe and cut wood trim to fit adjoining work, refinish cut surfaces, and repair damaged finish at cuts.
- D. Anchor wood trim to anchors or blocking built in or directly attached to substrates. Secure with countersunk, concealed fasteners and blind nailing. Use fine finishing nails for exposed fastening, countersunk and filled flush with woodwork.
- E. Standing and Running Trim: Install with minimum number of joints possible, using full-length pieces (from maximum length of lumber available) to greatest extent possible. Do not use pieces less than 36 inches (900 mm) long except where shorter single-length pieces are necessary.
- F. All joints to land on a stud.

END OF SECTION 064600

SECTION 092900 – GYPSUM BOARD

SECTION 092900 - GYPSUM BOARD

PART 1 - GENERAL

1.1 SUMMARY

A. Section Includes:

1. Interior gypsum board.

PART 2 - PRODUCTS

2.1 GYPSUM BOARD, GENERAL

- ###### A. Size: Provide maximum lengths and widths available that will minimize joints in each area and that correspond with support system indicated.

2.2 INTERIOR GYPSUM BOARD

A. Gypsum Board, Type X: ASTM C1396/C1396M.

1. Thickness: 5/8 inch (15.9 mm).
2. Long Edges: Tapered.

2.3 TRIM ACCESSORIES

A. Interior Trim: ASTM C1047.

1. Material: Galvanized or aluminum-coated steel sheet, rolled zinc, plastic, or paper-faced galvanized-steel sheet.
2. Shapes:
 - a. Cornerbead.
 - b. Bullnose bead.
 - c. LC-Bead: J-shaped; exposed long flange receives joint compound.

2.4 JOINT TREATMENT MATERIALS

A. General: Comply with ASTM C475/C475M.

B. Joint Tape:

1. Interior Gypsum Board: Paper.

SECTION 092900 – GYPSUM BOARD

- C. Joint Compound for Interior Gypsum Board: For each coat, use formulation that is compatible with other compounds applied on previous or for successive coats.
 - 1. Prefilling: At open joints and damaged surface areas, use setting-type taping compound.
 - 2. Embedding and First Coat: For embedding tape and first coat on joints, fasteners, and trim flanges, use setting-type taping compound.
 - 3. Fill Coat: For second coat, use setting-type, sandable topping compound.
 - 4. Finish Coat: For third coat, use setting-type, sandable topping compound.

2.5 AUXILIARY MATERIALS

- A. Steel Drill Screws: ASTM C1002 unless otherwise indicated.
 - 1. Use screws complying with ASTM C954 for fastening panels to steel members from 0.033 to 0.112 inch (0.84 to 2.84 mm) thick.
- B. Acoustical Sealant: Manufacturer's standard nonsag, paintable, nonstaining latex sealant complying with ASTM C834. Product effectively reduces airborne sound transmission through perimeter joints and openings in building construction as demonstrated by testing representative assemblies according to ASTM E90.
 - 1. Manufacturers: Subject to compliance with requirements, available manufacturers offering products that may be incorporated into the Work include, but are not limited to the following:
 - a. Accumetric LLC.
 - b. Pecora Corporation.
 - c. USG Corporation.

PART 3 - EXECUTION

3.1 APPLYING AND FINISHING PANELS

- A. Examine panels before installation. Reject panels that are wet, moisture damaged, and mold damaged.
- B. Comply with ASTM C840.
- C. Isolate perimeter of gypsum board applied to non-load-bearing partitions at structural abutments. Provide 1/4- to 1/2-inch- (6.4- to 12.7-mm-) wide spaces at these locations and trim edges with edge trim where edges of panels are exposed. Seal joints between edges and abutting structural surfaces with acoustical sealant.
- D. For trim with back flanges intended for fasteners, attach to framing with same fasteners used for panels. Otherwise, attach trim according to manufacturer's written instructions.
- E. Prefill open joints and damaged surface areas.

SECTION 092900 – GYPSUM BOARD

- F. Apply joint tape over gypsum board joints, except for trim products specifically indicated as not intended to receive tape.
- G. Gypsum Board Finish Levels: Finish panels to levels indicated below and according to ASTM C840:
 - 1. Level 4: At panel surfaces that will be exposed to view unless otherwise indicated.
 - a. Primer and its application to surfaces are specified in Section 099123 "Interior Painting."

3.2 PROTECTION

- A. Protect installed products from damage from condensation, direct sunlight, construction, and other causes during remainder of the construction period.
- B. Remove and replace panels that are wet, moisture damaged, and mold damaged.

END OF SECTION 092900

SECTION 095113 – ACOUSTICAL PANEL CEILINGS

SECTION 095113 - ACOUSTICAL PANEL CEILINGS

PART 1 - GENERAL

1.1 SUMMARY

- A. Section includes acoustical panels and exposed suspension systems for interior ceilings.

1.2 ACTION SUBMITTALS

- A. Product Data: For each type of product.

1.3 CLOSEOUT SUBMITTALS

- A. Maintenance data.

PART 2 - PRODUCTS

2.1 ACOUSTICAL PANELS – ACP:

- A. Manufacturers: Basis of Design: Provide the following or approved equal:
 - 1. Armstrong, Ultima High NRC
 - 2. Item No: Coordinate with existing track.
- B. Acoustical Panel Standard: Manufacturer's standard panels according to ASTM E1264.
- C. Classification: Type IV, Form 2, Pattern E, Fire Class A
- D. Color: White.
- E. Light Reflectance (LR): .88
- F. Ceiling Attenuation Class (CAC): 35
- G. Noise Reduction Coefficient (NRC): 0.08
- H. Articulation Class (AC): 170
- I. Edge/Joint Detail: Beveled Tegular
- J. Thickness: 7/8 inch (22 mm).
- K. Modular Size: 24 by 24 inches (610 by 610 mm).

SECTION 095113 – ACOUSTICAL PANEL CEILINGS

2.2 METAL SUSPENSION SYSTEM

- A. Manufacturers: Basis of Design: Provide the following or approved equal:
 - 1. Armstrong, Prelude 15/16”
- B. Metal Suspension-System Standard: Manufacturer's standard, direct-hung, metal suspension system and accessories according to ASTM C635/C635M.
- C. Wide-Face, Capped, Double-Web, Steel Suspension System: Main and cross runners roll formed from cold-rolled steel sheet; prepainted, electrolytically zinc coated, or hot-dip galvanized, G30 (Z90) coating designation; with prefinished 15/16-inch- (24-mm-) wide metal caps on flanges.
 - 1. Structural Classification: Intermediate-duty system.
 - 2. Face Design: Flat, flush.
 - 3. Cap Material: Cold-rolled steel.
 - 4. Cap Finish: Painted white.

2.3 ACCESSORIES

- A. Attachment Devices: Size for five times the design load indicated in ASTM C635/C635M, Table 1, "Direct Hung," unless otherwise indicated. Comply with seismic design requirements.
- B. Hold-Down Clips: Manufacturer's standard hold-down.
- C. Impact Clips: Manufacturer's standard impact-clip system designed to absorb impact forces against acoustical panels.
- D. Seismic Clips: Manufacturer's standard seismic clips designed to secure acoustical panels in place during a seismic event.

2.4 METAL EDGE MOLDINGS AND TRIM

- A. Roll-Formed, Sheet-Metal Edge Moldings and Trim: Type and profile indicated or, if not indicated, manufacturer's standard moldings for edges and penetrations that comply with seismic design requirements; formed from sheet metal of same material, finish, and color as that used for exposed flanges of suspension-system runners.

PART 3 - EXECUTION

3.1 PREPARATION

- A. Measure each ceiling area and establish layout of acoustical panels to balance border widths at opposite edges of each ceiling. Avoid using less-than-half-width panels at borders unless otherwise indicated.
- B. Layout openings for penetrations centered on the penetrating items.

SECTION 095113 – ACOUSTICAL PANEL CEILINGS

3.2 INSTALLATION

- A. Install acoustical panel ceilings according to ASTM C636/C636M, seismic design requirements, and manufacturer's written instructions.
- B. Install edge moldings and trim of type indicated at perimeter of acoustical ceiling area and where necessary to conceal edges of acoustical panels.
 - 1. Apply acoustical sealant in a continuous ribbon concealed on back of vertical legs of moldings before they are installed.
 - 2. Do not use exposed fasteners, including pop rivets, on moldings and trim.
 - 3. Arrange directionally patterned acoustical panels as follows:
 - a. As indicated on reflected ceiling plans.
 - 4. Install hold-down, impact and seismic clips in areas indicated; space according to panel manufacturer's written instructions unless otherwise indicated.

END OF SECTION 095113

SECTION 096513 - RESILIENT BASE AND ACCESSORIES

SECTION 096513 - RESILIENT BASE AND ACCESSORIES

PART 1 - GENERAL

1.1 RELATED DOCUMENTS

- A. Drawings and general provisions of the Contract, including General and Supplementary Conditions and Division 01 Specification Sections, apply to this Section.

1.2 SUMMARY

- A. Section Includes:
 - 1. Thermoset-rubber base.
 - 2. Rubber molding accessories.

1.3 ACTION SUBMITTALS

- A. Product Data: For each type of product.
- B. Samples for Initial Selection: For each type of product indicated.

1.4 MAINTENANCE MATERIAL SUBMITTALS

- A. Furnish extra materials, from the same product run, that match products installed and that are packaged with protective covering for storage and identified with labels describing contents.
 - 1. Furnish not less than 10 linear feet (3 linear m) for every 500 linear feet (150 linear m) or fraction thereof, of each type, color, pattern, and size of resilient product installed.

1.5 DELIVERY, STORAGE, AND HANDLING

- A. Store resilient products and installation materials in dry spaces protected from the weather, with ambient temperatures maintained within range recommended by manufacturer, but not less than 50 deg F (10 deg C) or more than 90 deg F (32 deg C).

1.6 FIELD CONDITIONS

- A. Maintain ambient temperatures within range recommended by manufacturer, but not less than 70 deg F (21 deg C) or more than 95 deg F (35 deg C), in spaces to receive resilient products during the following periods:
 - 1. 48 hours before installation.
 - 2. During installation.

SECTION 096513 - RESILIENT BASE AND ACCESSORIES

3. 48 hours after installation.
- B. After installation and until Substantial Completion, maintain ambient temperatures within range recommended by manufacturer, but not less than 55 deg F (13 deg C) or more than 95 deg F (35 deg C).
- C. Install resilient products after other finishing operations, including painting, have been completed.

PART 2 - PRODUCTS

2.1 THERMOSET-RUBBER BASE – RUB:

- A. Manufacturers: Subject to compliance with requirements, available manufacturers offering products that may be incorporated into the Work include, but are not limited to the following:
 1. Burke Mercer Flooring Products; a division of Burke Industries Inc.
 2. Flexco.
 3. Roppe Corporation, USA.
- B. Product Standard: ASTM F1861, Type TS (rubber, vulcanized thermoset), Group I (solid, homogeneous).
 1. Style:
 - a. Style B, Cove
- C. Thickness: 0.125 inch (3.2 mm).
- D. Height: 4 inches (102 mm).
- E. Lengths: Coils in manufacturer's standard length.
- F. Outside Corners: Job formed.
- G. Inside Corners: Job formed.
- H. Colors: As selected by Architect from manufacturer's full range.

2.2 RUBBER MOLDING ACCESSORY

- A. Description: Rubber reducer strip for resilient floor covering; transition strips.
- B. Profile and Dimensions: As indicated.
- C. Locations: Floor finish transitions.
- D. Colors and Patterns: Match rubber base.

SECTION 096513 - RESILIENT BASE AND ACCESSORIES

2.3 INSTALLATION MATERIALS

- A. Trowelable Leveling and Patching Compounds: Latex-modified, portland-cement-based or blended hydraulic-cement-based formulation provided or approved by resilient-product manufacturer for applications indicated.
- B. Adhesives: Water-resistant type recommended by resilient-product manufacturer for resilient products and substrate conditions indicated.
- C. Metal Edge Strips: Extruded aluminum with mill finish, nominal 2 inches (50.8 mm) wide, of height required to protect exposed edges of flooring, and in maximum available lengths to minimize running joints.

PART 3 - EXECUTION

3.1 EXAMINATION

- A. Examine substrates, with Installer present, for compliance with requirements for maximum moisture content and other conditions affecting performance of the Work.
 - 1. Verify that finishes of substrates comply with tolerances and other requirements specified in other Sections and that substrates are free of cracks, ridges, depressions, scale, and foreign deposits that might interfere with adhesion of resilient products.
- B. Proceed with installation only after unsatisfactory conditions have been corrected.
 - 1. Installation of resilient products indicates acceptance of surfaces and conditions.

3.2 PREPARATION

- A. Prepare substrates according to manufacturer's written instructions to ensure adhesion of resilient products.
- B. Fill cracks, holes, and depressions in substrates with trowelable leveling and patching compound; remove bumps and ridges to produce a uniform and smooth substrate.
- C. Do not install resilient products until materials are the same temperature as space where they are to be installed.
 - 1. At least 48 hours in advance of installation, move resilient products and installation materials into spaces where they will be installed.

3.3 RESILIENT BASE INSTALLATION

- A. Comply with manufacturer's written instructions for installing resilient base.
- B. Apply resilient base to walls, columns, pilasters, casework and cabinets in toe spaces, and other permanent fixtures in rooms and areas where base is required.

SECTION 096513 - RESILIENT BASE AND ACCESSORIES

- C. Install resilient base in lengths as long as practical without gaps at seams and with tops of adjacent pieces aligned.
- D. Tightly adhere resilient base to substrate throughout length of each piece, with base in continuous contact with horizontal and vertical substrates.
- E. Do not stretch resilient base during installation.
- F. On masonry surfaces or other similar irregular substrates, fill voids along top edge of resilient base with manufacturer's recommended adhesive filler material.
- G. Job-Formed Corners:
 - 1. Outside Corners: Use straight pieces of maximum lengths possible and form with returns not less than 3 inches (76 mm) in length.
 - 2. Inside Corners: Use straight pieces of maximum lengths possible and form with returns not less than 3 inches (76 mm) in length.

3.4 RESILIENT ACCESSORY INSTALLATION

- A. Comply with manufacturer's written instructions for installing resilient accessories.
- B. Resilient Molding Accessories: Butt to adjacent materials and tightly adhere to substrates throughout length of each piece. Install reducer strips at edges of floor covering that would otherwise be exposed.

3.5 CLEANING AND PROTECTION

- A. Comply with manufacturer's written instructions for cleaning and protecting resilient products.
- B. Perform the following operations immediately after completing resilient-product installation:
 - 1. Remove adhesive and other blemishes from surfaces.
- C. Protect resilient products from mars, marks, indentations, and other damage from construction operations and placement of equipment and fixtures during remainder of construction period.

END OF SECTION 096513

SECTION 096519 - RESILIENT TILE FLOORING

SECTION 096519 - RESILIENT TILE FLOORING

PART 1 - GENERAL

1.1 RELATED DOCUMENTS

- A. Drawings and general provisions of the Contract, including General and Supplementary Conditions and Division 01 Specification Sections, apply to this Section.

1.2 SUMMARY

- A. Section Includes:
 - 1. Solid vinyl floor tile.

1.3 ACTION SUBMITTALS

- A. Product Data: For each type of product.
- B. Samples for Initial Selection: For each type of floor tile indicated.

1.4 CLOSEOUT SUBMITTALS

- A. Maintenance Data: For each type of floor tile to include in maintenance manuals.

1.5 MAINTENANCE MATERIAL SUBMITTALS

- A. Furnish extra materials, from the same product run, that match products installed and that are packaged with protective covering for storage and identified with labels describing contents.
 - 1. Floor Tile: Furnish one box for every 50 boxes or fraction thereof, of each type, color, and pattern of floor tile installed.

1.6 QUALITY ASSURANCE

- A. Installer Qualifications: An entity that employs installers and supervisors who are competent in techniques required by manufacturer for floor tile installation and seaming method indicated.

1.7 DELIVERY, STORAGE, AND HANDLING

- A. Store floor tile and installation materials in dry spaces protected from the weather, with ambient temperatures maintained within range recommended by manufacturer, but not less than 50 deg F (10 deg C) or more than 90 deg F (32 deg C). Store floor tiles on flat surfaces.

SECTION 096519 - RESILIENT TILE FLOORING

1.8 FIELD CONDITIONS

- A. Maintain ambient temperatures within range recommended by manufacturer, but not less than 70 deg F (21 deg C) or more than 95 deg F (35 deg C), in spaces to receive floor tile during the following periods:
 - 1. 48 hours before installation.
 - 2. During installation.
 - 3. 48 hours after installation.
- B. After installation and until Substantial Completion, maintain ambient temperatures within range recommended by manufacturer, but not less than 55 deg F (13 deg C) or more than 95 deg F (35 deg C).
- C. Close spaces to traffic during floor tile installation.
- D. Close spaces to traffic for 48 hours after floor tile installation.
- E. Install floor tile after other finishing operations, including painting, have been completed.

PART 2 - PRODUCTS

2.1 PERFORMANCE REQUIREMENTS

- A. Fire-Test-Response Characteristics: For resilient floor tile, as determined by testing identical products according to ASTM E648 or NFPA 253 by a qualified testing agency.
 - 1. Critical Radiant Flux Classification: Class I, not less than 0.45 W/sq. cm.

2.2 SOLID VINYL FLOOR TILE – LVT:

- 1. Mohawk, Hot and Heavy Collection
- 2. Series: Bolder
- B. Tile Standard: ASTM F1700.
 - 1. Class: Class III, Printed Film Vinyl Tile.
 - 2. Type: Light Emboss
- C. Thickness: 5 mm
- D. Size: 36 by 36 inches (914 by 914 mm).
- E. Installation Method: Loose lay with perimeter glue.
- F. Colors and Patterns: As selected by Architect from Manufacturer's full range.

SECTION 096519 - RESILIENT TILE FLOORING

2.3 INSTALLATION MATERIALS

- A. Trowelable Leveling and Patching Compounds: Latex-modified, portland-cement-based or blended hydraulic-cement-based formulation provided or approved by floor tile manufacturer for applications indicated.
- B. Adhesives: Water-resistant type recommended by floor tile and adhesive manufacturers to suit floor tile and substrate conditions indicated.

PART 3 - EXECUTION

3.1 EXAMINATION

- A. Examine substrates, with Installer present, for compliance with requirements for maximum moisture content and other conditions affecting performance of the Work.
 - 1. Verify that finishes of substrates comply with tolerances and other requirements specified in other Sections and that substrates are free of cracks, ridges, depressions, scale, and foreign deposits that might interfere with adhesion of floor tile.
- B. Proceed with installation only after unsatisfactory conditions have been corrected.

3.2 PREPARATION

- A. Prepare substrates according to floor tile manufacturer's written instructions to ensure adhesion of resilient products.
- B. Concrete Substrates: Prepare according to ASTM F710.
 - 1. Verify that substrates are dry and free of curing compounds, sealers, and hardeners.
 - 2. Remove substrate coatings and other substances that are incompatible with adhesives and that contain soap, wax, oil, or silicone, using mechanical methods recommended by floor tile manufacturer. Do not use solvents.
 - 3. Alkalinity and Adhesion Testing: Perform tests recommended by floor tile manufacturer. Proceed with installation only after substrate alkalinity falls within range on pH scale recommended by manufacturer in writing.
 - 4. Moisture Testing: Perform tests so that each test area does not exceed 200 sq. ft. (18.6 sq. m), and perform no fewer than three tests in each installation area and with test areas evenly spaced in installation areas, or as recommended by flooring manufacturer, and tests may include:
 - a. Anhydrous Calcium Chloride Test: ASTM F1869. Proceed with installation only after substrates have maximum moisture-vapor-emission rate of 3 lb of water/1000 sq. ft. (1.36 kg of water/92.9 sq. m) in 24 hours.
 - b. Relative Humidity Test: Using in-situ probes, ASTM F2170. Proceed with installation only after substrates have a maximum 95 percent relative humidity level measurement.

SECTION 096519 - RESILIENT TILE FLOORING

- C. Fill cracks, holes, and depressions in substrates with trowelable leveling and patching compound; remove bumps and ridges to produce a uniform and smooth substrate.
- D. Do not install floor tiles until materials are the same temperature as space where they are to be installed.
 - 1. At least 48 hours in advance of installation, move resilient floor tile and installation materials into spaces where they will be installed.
- E. Immediately before installation, sweep and vacuum clean substrates to be covered by resilient floor tile.

3.3 FLOOR TILE INSTALLATION

- A. Comply with manufacturer's written instructions for installing floor tile.
- B. Lay out floor tiles from center marks established with principal walls, discounting minor offsets, so tiles at opposite edges of room are of equal width. Adjust as necessary to avoid using cut widths that equal less than one-half tile at perimeter.
 - 1. Lay tiles square with room axis.
- C. Match floor tiles for color and pattern by selecting tiles from cartons in the same sequence as manufactured and packaged, if so numbered. Discard broken, cracked, chipped, or deformed tiles.
- D. Scribe, cut, and fit floor tiles to butt neatly and tightly to vertical surfaces and permanent fixtures including built-in furniture, cabinets, pipes, outlets, and door frames.
- E. Extend floor tiles into toe spaces, door reveals, closets, and similar openings. Extend floor tiles to center of door openings.
- F. Maintain reference markers, holes, and openings that are in place or marked for future cutting by repeating on floor tiles as marked on substrates. Use chalk or other nonpermanent marking device.
- G. Install floor tiles on covers for telephone and electrical ducts, building expansion-joint covers, and similar items in installation areas. Maintain overall continuity of color and pattern between pieces of tile installed on covers and adjoining tiles. Tightly adhere tile edges to substrates that abut covers and to cover perimeters.
- H. Adhere floor tiles to substrates using a full spread of adhesive applied to substrate to produce a completed installation without open cracks, voids, raising and puckering at joints, telegraphing of adhesive spreader marks, and other surface imperfections.

3.4 CLEANING AND PROTECTION

- A. Comply with manufacturer's written instructions for cleaning and protecting floor tile.
- B. Perform the following operations immediately after completing floor tile installation:

SECTION 096519 - RESILIENT TILE FLOORING

1. Remove adhesive and other blemishes from surfaces.
 2. Sweep and vacuum surfaces thoroughly.
 3. Damp-mop surfaces to remove marks and soil.
- C. Protect floor tile from mars, marks, indentations, and other damage from construction operations and placement of equipment and fixtures during remainder of construction period.
- D. Cover floor tile until Substantial Completion.

END OF SECTION 096519

SECTION 099123 - INTERIOR PAINTING

SECTION 099123 - INTERIOR PAINTING

PART 1 - GENERAL

1.1 SUMMARY

- A. Section includes surface preparation and the application of paint systems on the following interior substrates:
 - 1. Gypsum board.

1.2 DEFINITIONS

- A. MPI Gloss Level 5: 35 to 70 units at 60 degrees, according to ASTM D523.

1.3 ACTION SUBMITTALS

- A. Product Data: For each type of product. Include preparation requirements and application instructions.

PART 2 - PRODUCTS

2.1 MANUFACTURERS

- A. Manufacturers: Subject to compliance with requirements, available manufacturers offering products that may be incorporated into the Work include, but are not limited to the following:
 - 1. Benjamin Moore & Co.
 - 2. Sherwin-Williams Company (The).
- B. Products: Subject to compliance with requirements, available products that may be incorporated into the Work include, but are not limited to products listed in the Interior Painting Schedule for the paint category indicated.

2.2 PAINT, GENERAL

- A. MPI Standards: Products shall comply with MPI standards indicated and shall be listed in its "MPI Approved Products Lists."
- B. Material Compatibility:
 - 1. Materials for use within each paint system shall be compatible with one another and substrates indicated, under conditions of service and application as demonstrated by manufacturer, based on testing and field experience.

SECTION 099123 - INTERIOR PAINTING

2. For each coat in a paint system, products shall be recommended in writing by topcoat manufacturers for use in paint system and on substrate indicated.
- C. Colors: As selected by Architect from manufacturer's full range.

PART 3 - EXECUTION

3.1 EXAMINATION

- A. Examine substrates and conditions, with Applicator present, for compliance with requirements for maximum moisture content and other conditions affecting performance of the Work.
- B. Maximum Moisture Content of Substrates: When measured with an electronic moisture meter as follows:
 1. Gypsum Board: 12 percent.
- C. Verify suitability of substrates, including surface conditions and compatibility with existing finishes and primers.
- D. Proceed with coating application only after unsatisfactory conditions have been corrected.
 1. Application of coating indicates acceptance of surfaces and conditions.

3.2 PREPARATION

- A. Comply with manufacturer's written instructions and recommendations in "MPI Architectural Painting Specification Manual" applicable to substrates and paint systems indicated.
- B. Remove hardware, covers, plates, and similar items already in place that are removable and are not to be painted. If removal is impractical or impossible because of size or weight of item, provide surface-applied protection before surface preparation and painting.
 1. After completing painting operations, use workers skilled in the trades involved to reinstall items that were removed. Remove surface-applied protection if any.

3.3 APPLICATION

- A. Apply paints according to manufacturer's written instructions and recommendations in "MPI Architectural Painting Specification Manual."
- B. Apply paints to produce surface films without cloudiness, spotting, holidays, laps, brush marks, roller tracking, runs, sags, ropiness, or other surface imperfections. Cut in sharp lines and color breaks.

SECTION 099123 - INTERIOR PAINTING

3.4 INTERIOR PAINTING SCHEDULE

A. Gypsum Board Substrates:

1. Institutional Low-Odor/VOC Latex System MPI INT 9.2M:
 - a. Prime Coat: Primer sealer, interior, institutional low odor/VOC, MPI #149. Omit at pre-painted surfaces.
 - b. Intermediate Coat: Latex, interior, institutional low odor/VOC, matching topcoat.
 - c. Topcoat: Latex, interior, institutional low odor/VOC, semi-gloss (MPI Gloss Level 5), MPI #147.

END OF SECTION 099123

CITY & BOROUGH OF JUNEAU

DOUGLAS LIBRARY

MEETING ROOM RENOVATION

JUNEAU, AK

JUNE 1, 2020

CBJ Proj. No. BE20-259

CODE SUMMARY

OCCUPANCY GROUP:

APPARATUS AREA B-2
LIVING QUARTERS R-3
LIBRARY A-3

CURRENT PROJECT:
MEETING ROOM A-3

CONSTRUCTION TYPE:
TYPE II - 1 HR

MEETING ROOM: 920 SF

SHEET INDEX

A001 COVER SHEET/ CODE DATA/ ABBREVIATIONS
A201 MAIN FLOOR - OVERALL PLAN
AD101 ENLARGED DEMO PLAN
A401 ENLARGED RENO PLAN
A601 ENLARGED REFLECTED CEILING PLAN
A901 INTERIOR DETAILS

E201 ELECTRICAL PLANS

CONSULTANTS

ARCHITECT

JENSEN YORBA WALL, INC

522 WEST 10TH STREET
JUNEAU, ALASKA 99801
(907) 586-1070
FAX (844) 350-5352

ELECTRICAL ENGINEER

BEGENYI ENGINEERING, LLC

217 2ND STREET, SUITE 208
JUNEAU, ALASKA, 99801
(907) 586-5900
FAX (907) 586-5901

SYMBOLS

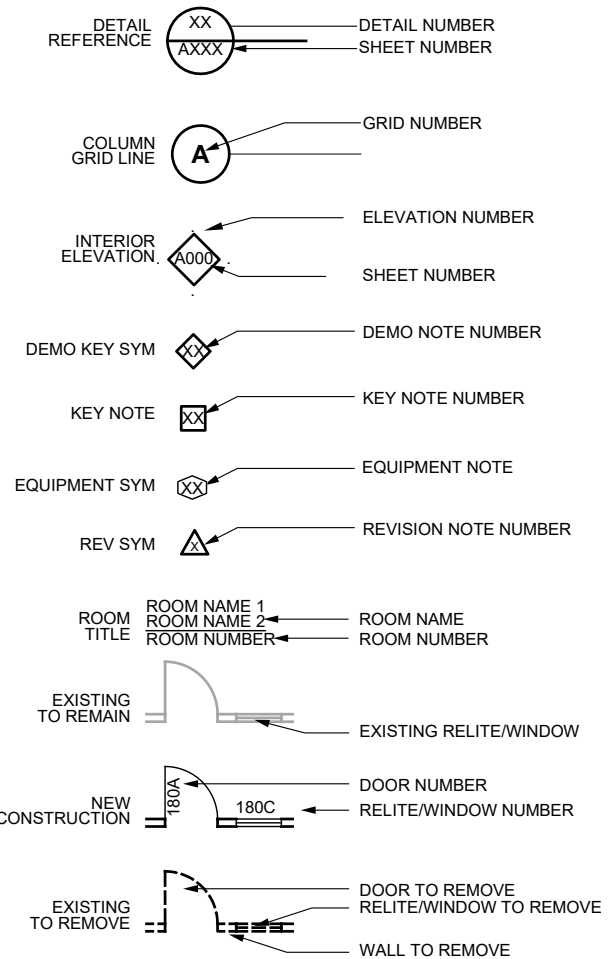

ABBREVIATIONS

ACP	ACOUSTICAL CEILING PANEL	FF	FINISH FLOOR	NTS	NOT TO SCALE
ADJ	ADJUSTABLE	FIN	FINISH FLOOR	OFCI	OWNER FURNISHED CONTRACTOR INSTALLED
AFF	ABOVE FINISH FLOOR	FLR	FLOOR	OFOI	OWNER FURNISHED CONTRACTOR INSTALLED
ARCH	ARCHITECTURAL	FT	FOOT OR FEET	OFD	OWNER INSTALLED OVERFLOW DRAIN
BLDG	BUILDING	GWB	GYPSUM WALL BOARD	REQ	REQUIRED
BLKG	BLOCKING	HM	HOLLOW METAL	RM	ROOM
BOT	BOTTOM	HORIZ	HORIZONTAL	RUB	RUBBER
		HT	HEIGHT	SCHED	SCHEDULE
CLG	CEILING	JAN	JANITOR	SF	SQUARE FOOT
COL	COLUMN	MECH	MECHANICAL	SIM	SIMILAR
CONC	CONCRETE	MFR	MANUFACTURER	STD	STANDARD
CONT	CONTINUOUS	MIN	MINIMUM	STOR	STORAGE
		MISC	MISCELLANEOUS	STRUCT	STRUCTURAL
DBL	DOUBLE	MTL	METAL	TEMP	TEMPORARY
DET	DETAIL	NIC	NOT IN CONTRACT	TYP	TYPICAL
DIA	DIAMETER			UON	UNLESS OTHERWISE NOTED
DIM	DIMENSION			VERT	VERTICAL
DN	DOWN			WD	WOOD
DR	DOOR				
DWG	DRAWING				
EA	EACH				
ELEC	ELECTRICAL				
ELEV	ELEVATOR				
EQ	EQUAL				
EX	EXISTING				

GENERAL NOTES

1. CONTRACTOR VERIFY EX CONDITIONS BEFORE BEGINNING WORK.
2. PROTECT EX FINISHES TO REMAIN DURING DEMO AND RENO WORK.
3. COORDINATE SALVAGE OF EXISTING EQUIPMENT TO BE RE-INSTALLED WITH OWNER.

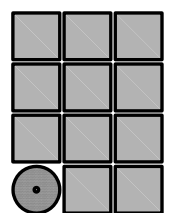

Jensen
Yorba
Wall Inc.

522 West 10th Street
Juneau, Alaska 99801
907.586.1070
AECC137
jensenyorbawall.com

FILE:20014

A001

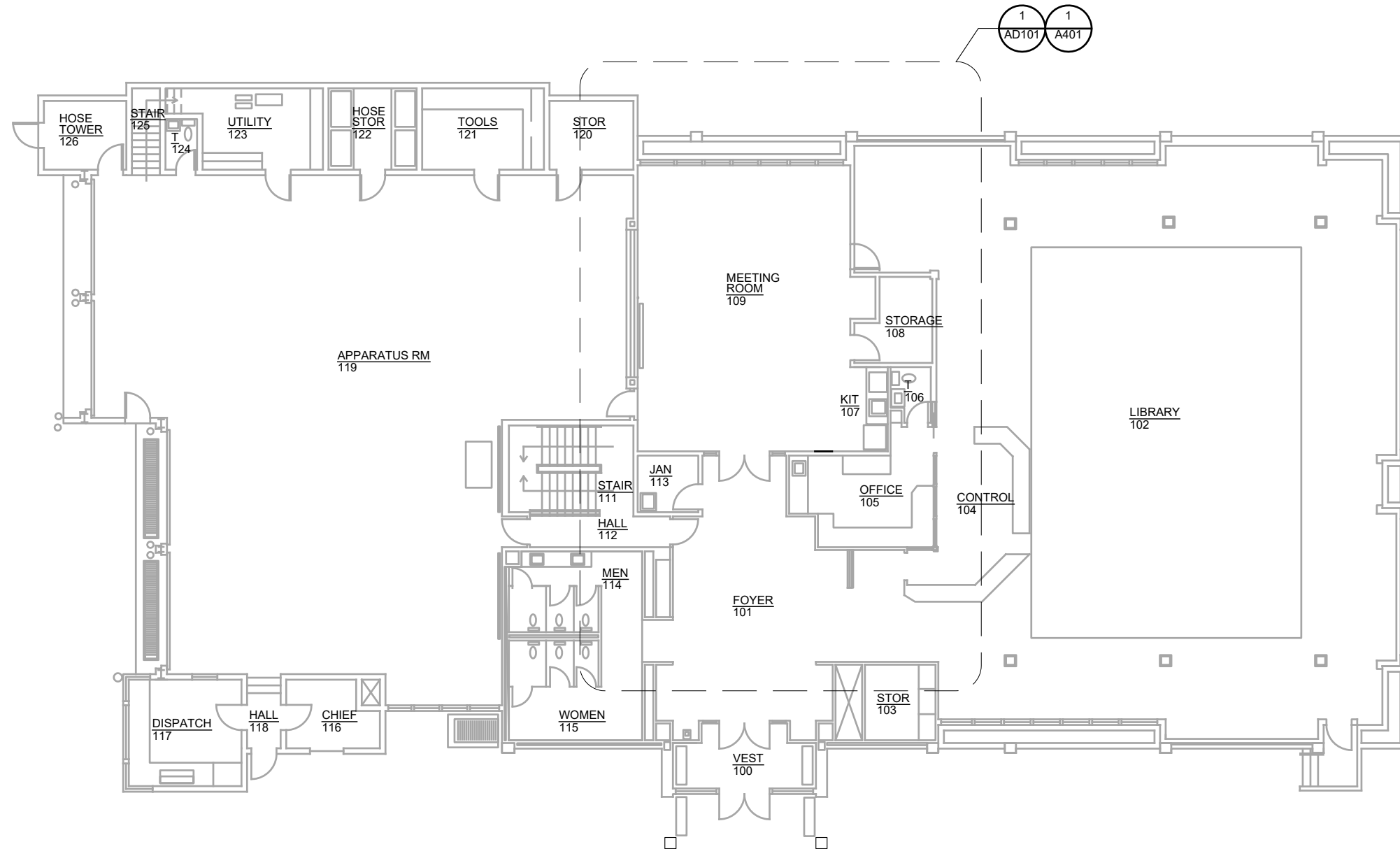

1 MAIN FLOOR - OVERALL PLAN

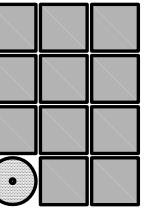
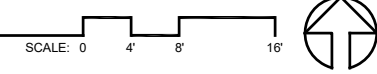

Jensen
Yorba
Wall Inc.

522 West 10th Street
Juneau, Alaska 99801
907.586.1070
AECC137
jensenyorbawall.com

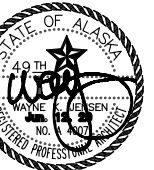

City & Borough of Juneau
Douglas Library
MEETING ROOM RENOVATION
Juneau, Alaska
CBJ PROJ. NO. BE 20-259

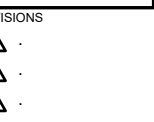

SHEET TITLE
MAIN FLOOR
OVERALL PLAN

DATE: JUNE 1, 2020
FILE: 20014

A201

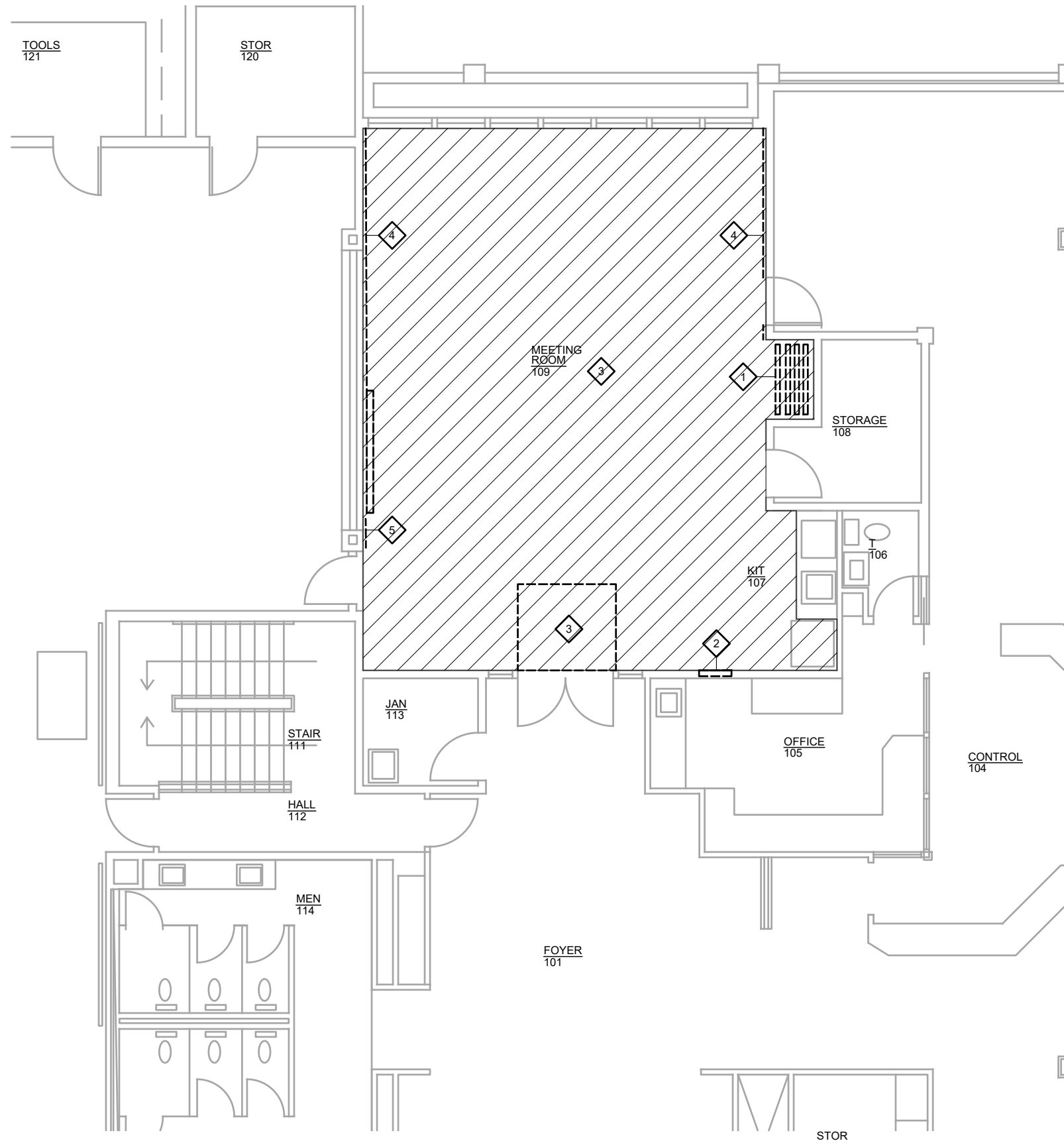

DEMOLITION LEGEND

- PROTECT EX SURFACES DURING DEMOLITION
 - SEE A601 FOR CEILING DEMO AND COORDINATION
 - SALVAGE WALL MOUNTED FIXTURES AND EQUIPMENT AS REQ'D FOR NEW WORK
- 1 REMOVE DIVIDING WALL, AND WALL BUMPER. CEILING TRACK TO REMAIN
 - 2 REMOVE WALL RECESSED FOLD DOWN TABLE
 - 3  REMOVE WOOD FLOORING, CARPET, AND BASE, PREP CONC FOR FLOOR FINISH AS SCHEDULED. SALVAGE DOOR THRESHOLDS
 - 4 REMOVE CONTACT PAPER FROM WALL SURFACE. PREP GWB FOR FINISH AS SCHEDULED
 - 5 REMOVE GWB AS REQ'D FOR ELECTRICAL WORK AT EX WALL

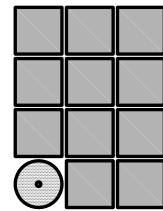

Jensen
Yorba
Wall Inc.

522 West 10th Street
Juneau, Alaska 99801
907.586.1070
AECC137
jensenyorbawall.com

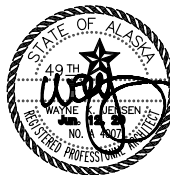

City & Borough of Juneau
Douglas Library
MEETING ROOM RENOVATION
Juneau, Alaska
CBJ PROJ. NO. BE 20-259

REVISIONS



SHEET TITLE

ENLARGED DEMO
PLAN

DATE: JUNE 1, 2020
FILE: 20014

AD101

1 ENLARGED DEMO PLAN

SCALE: 0 2' 4' 8'



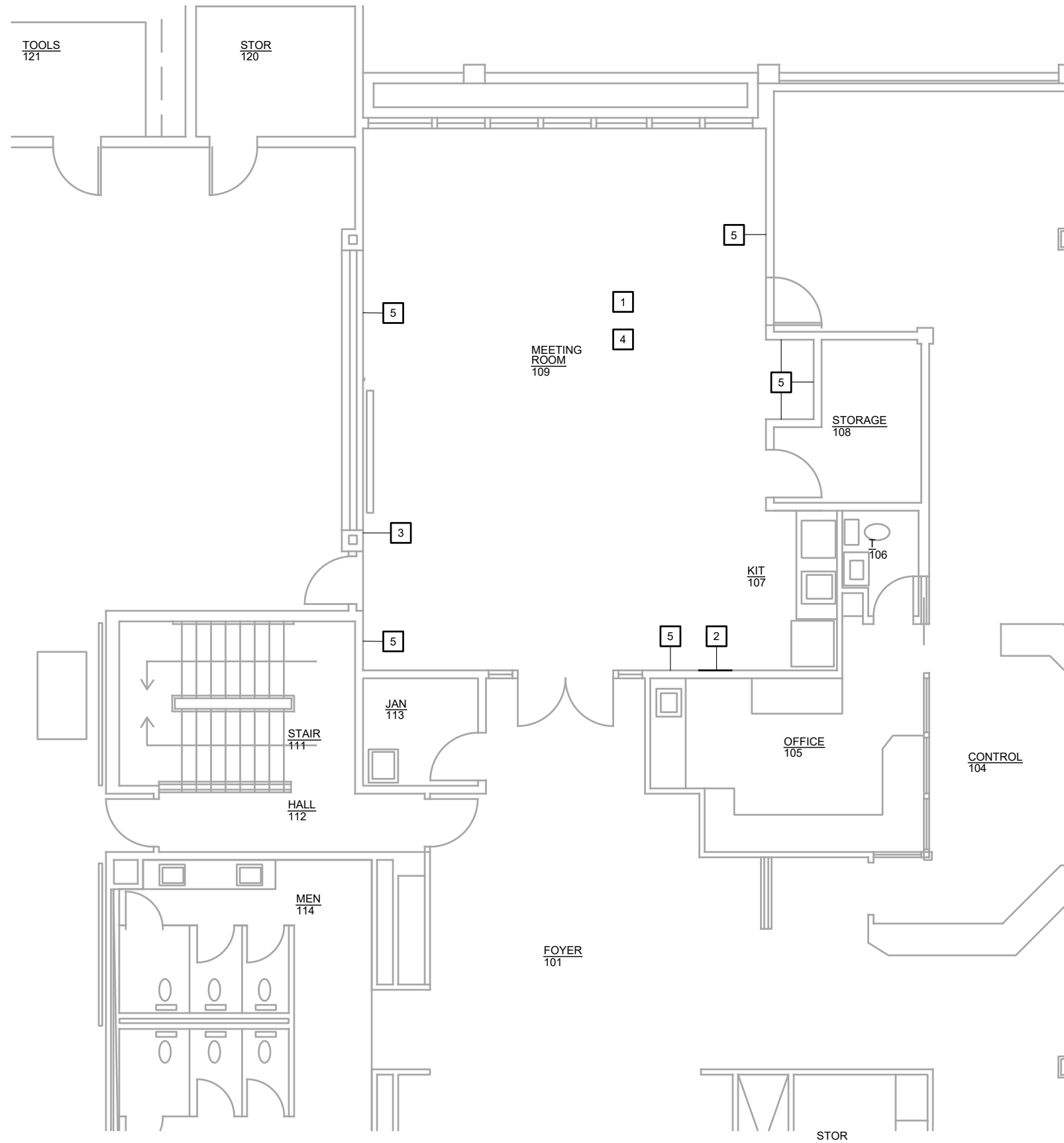

RENOVATION LEGEND

- PATCH SURFACES WHERE DEMO WORK HAS OCCURRED
- FINISH TO MATCH ADJACENT SURFACE
- RE-INSTALL WALL MOUNTED FIXTURES AND EQUIPMENT. COORD WITH OWNER

- 1** PATCH AND PAINT ALL WALLS
- 2** PATCH WALL WHERE TABLE IS REMOVED: 6" MTL STUD WITH 5/8" GWB; FINISH TO MATCH ADJ SURFACE
- 3** PATCH WALL FOR ELECT WORK ; FINISH AS SCHEDULED
- 4** PROVIDE LVT FLOOR FINISH AND RUB BASE. REUSE OR REPLACE THRESHOLDS AT DOORS
- 5** 1x8 HARDWOOD WALL TRIM @ 30" TO CENTERLINE. STAIN NATURAL.

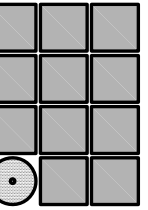

Jensen
Yorba
Wall Inc.

522 West 10th Street
Juneau, Alaska 99801
907.586.1070
AECC137
jensenyorbawall.com



City & Borough of Juneau
Douglas Library
MEETING ROOM RENOVATION
Juneau, Alaska
CBJ PROJ. NO. BE 20-259

REVISIONS



SHEET TITLE
ENLARGED PLAN

DATE: JUNE 1, 2020
FILE: 20014

1 ENLARGED RENO PLAN

SCALE: 0 2' 4' 8'



A401

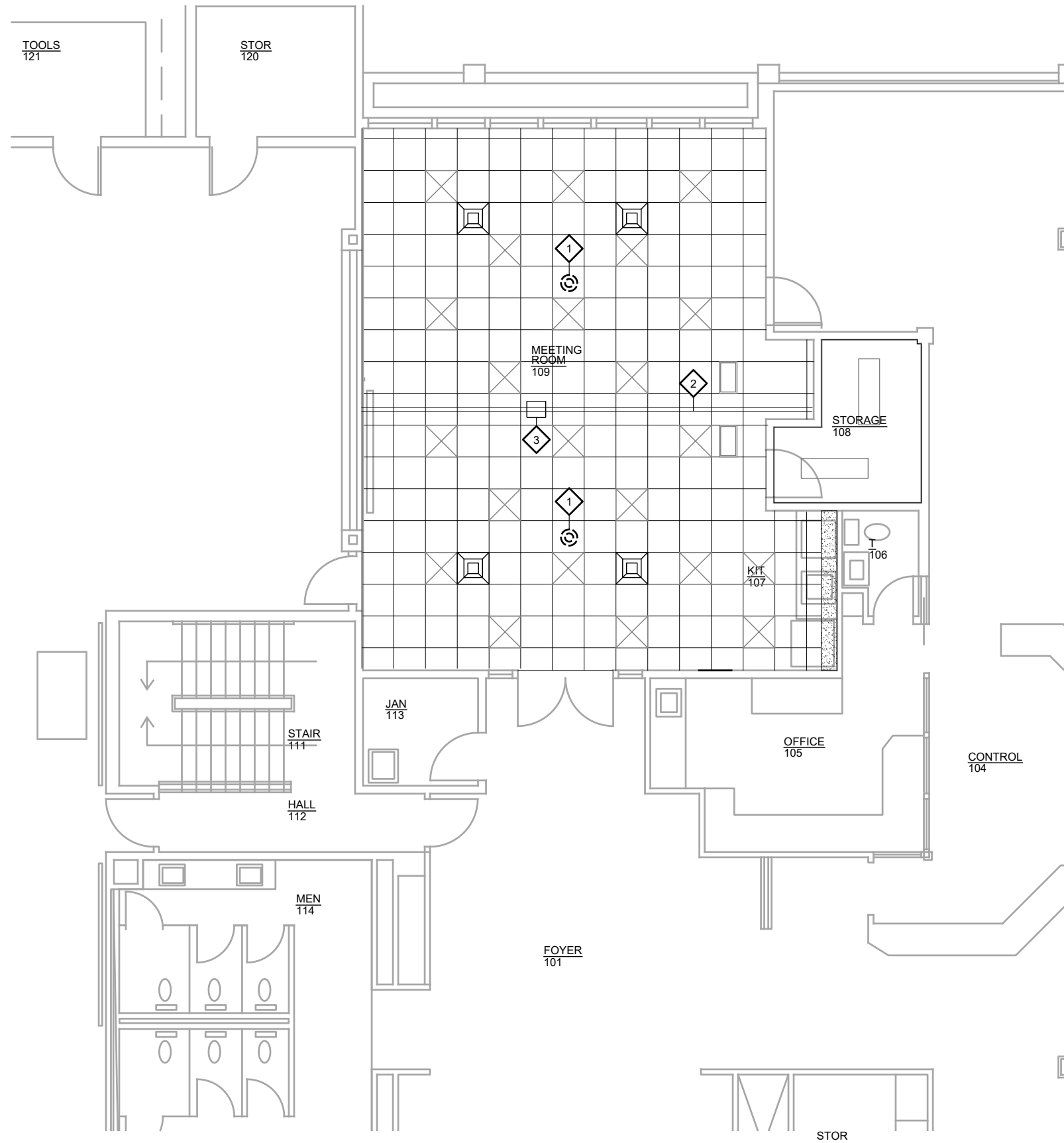

RCP LEGEND

- EX CLG HT 8' - 9" TO REMAIN
- EX CLG FINISHES TO REMAIN OUTSIDE PROJECT AREA.
- EX MECH/ELECT CLG MOUNTED EQUIP IS APPROXIMATE, CONTRACTOR VERIFY BEFORE BEGINNING WORK
- REMOVE AND REINSTALL EX CLG EQUIPMENT AS REQ'D FOR NEW WORK UON. COORD WITH ELECT

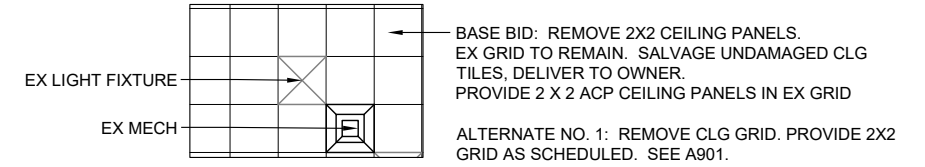

- 1 REMOVE EX SPEAKERS; COORD WITH ELECT
- 2 ALTERNATE NO.1: REMOVE CEILING MOUNTED DIVIDING CURTAIN TRACK
- 3 REMOVE AND REINSTALL CLG MOUNTED PROJECTOR AS REQ'D FOR CLG WORK

1 MAIN FLOOR ENLARGED REFLECTED CEILING PLAN

SCALE: 0 2' 4' 8'

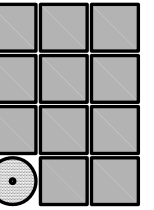

Jensen
Yorba
Wall Inc.

522 West 10th Street
Juneau, Alaska 99801
907.586.1070
AECC137
jensenyorbawall.com

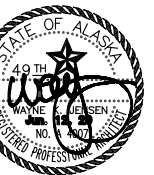

City & Borough of Juneau
Douglas Library
MEETING ROOM RENOVATION
Juneau, Alaska
CBJ PROJ. NO. BE 20-259

REVISIONS



SHEET TITLE
ENLARGED PLAN
REFLECTED CLG

DATE: JUNE 1, 2020
FILE: 20014

A601

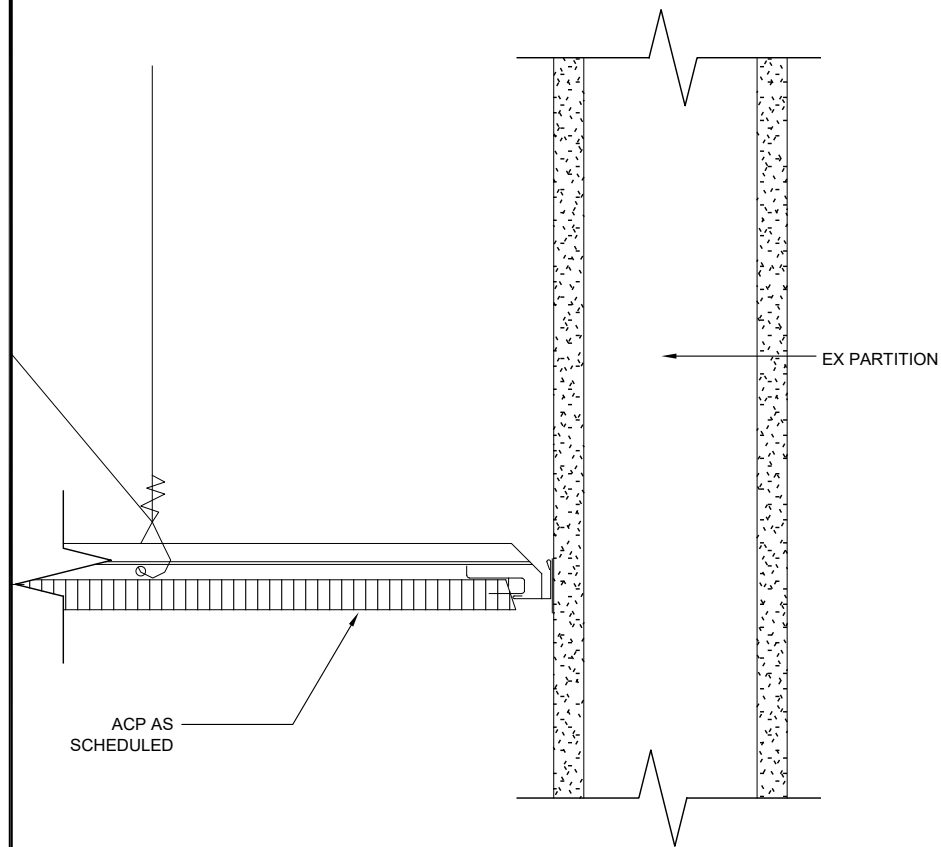

1 ACP @ WALL TYP
20014/A901-1 SCALE: 0 3" 6"

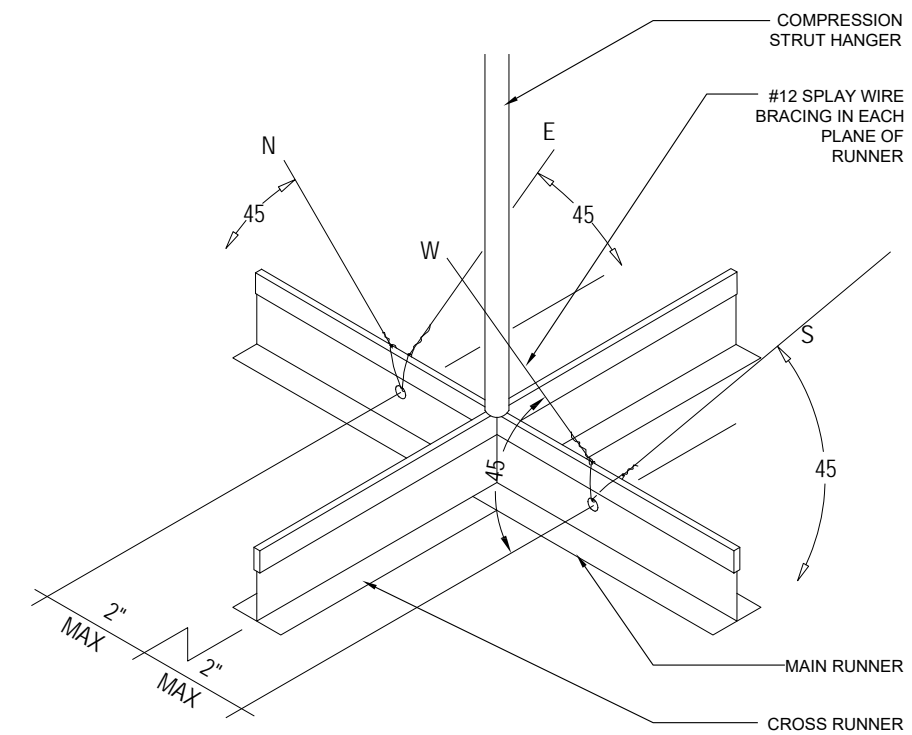

NOTE: ACOUSTICAL PANEL CEILINGS, LIGHT FIXTURES AND DIFFUSERS ARE TO BE IN COFORMANCE WITH IBC 1621.2.5 (SEISMIC DESIGN CATEGORY D) AND CISCA STANDARDS

2 ADD ALTERNATE: TYP CEILING BRACING
20014/A901-2 SCALE: 0 3" 6" 1'

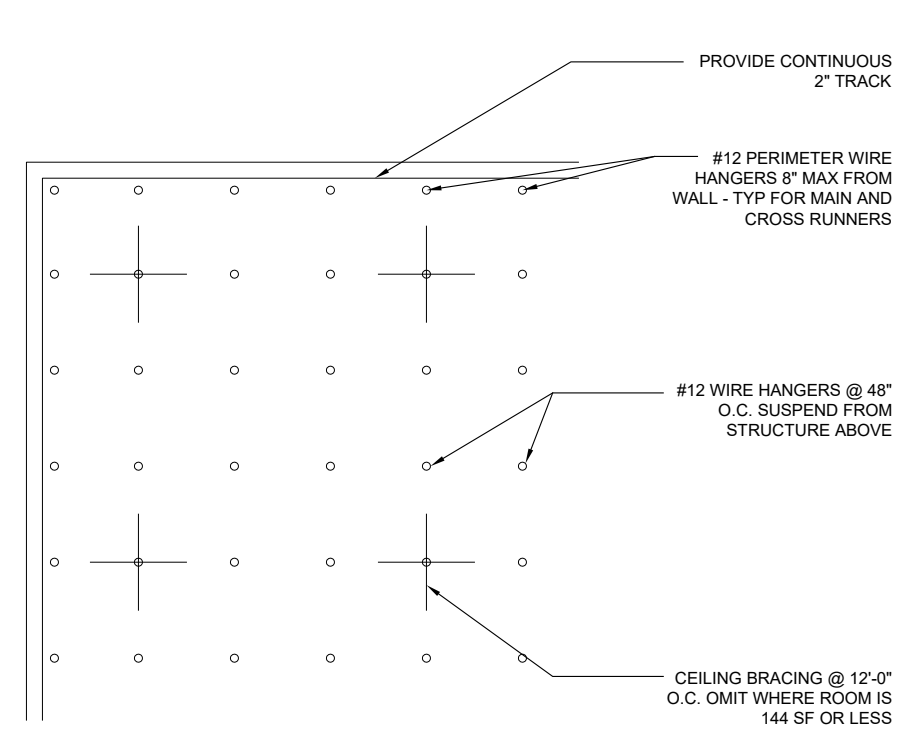

3 ADD ALTERNATE: TYP BRACING LAYOUT
20014/A901-3 SCALE: 0 3" 6" 1'

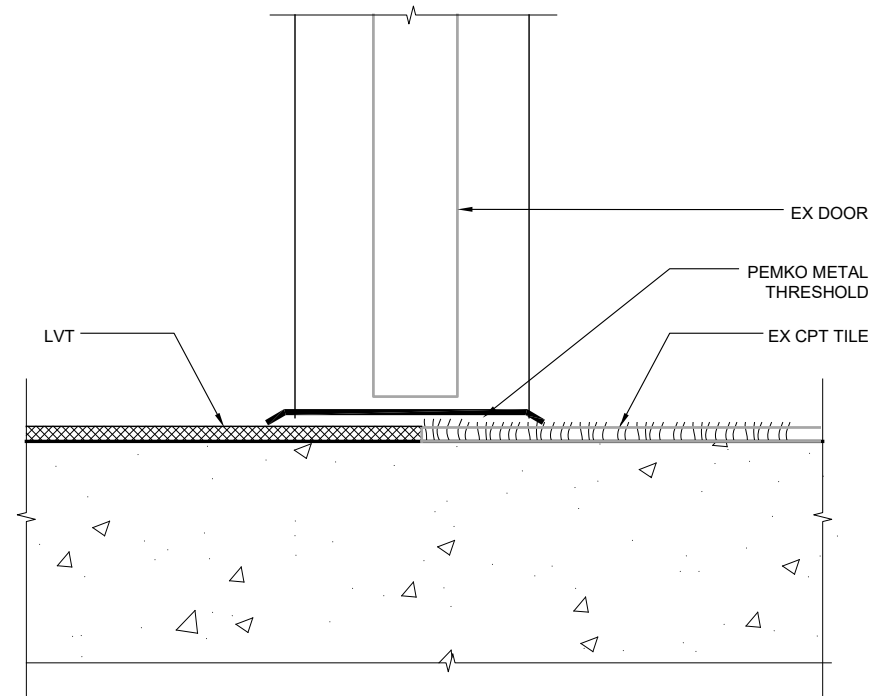

4 FLOOR TRANSITION LVT TO CPT
20014/A901-4 SCALE: 0 3" 6"

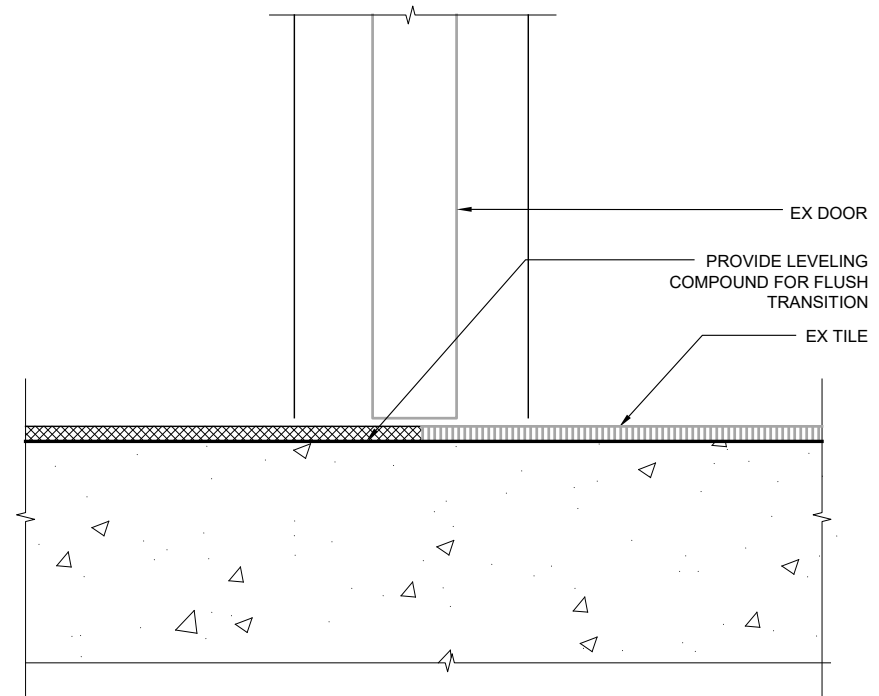

5 FLOOR TRANSITIONS LVT TO TILE
20014/A901-5 SCALE: 0 3" 6"

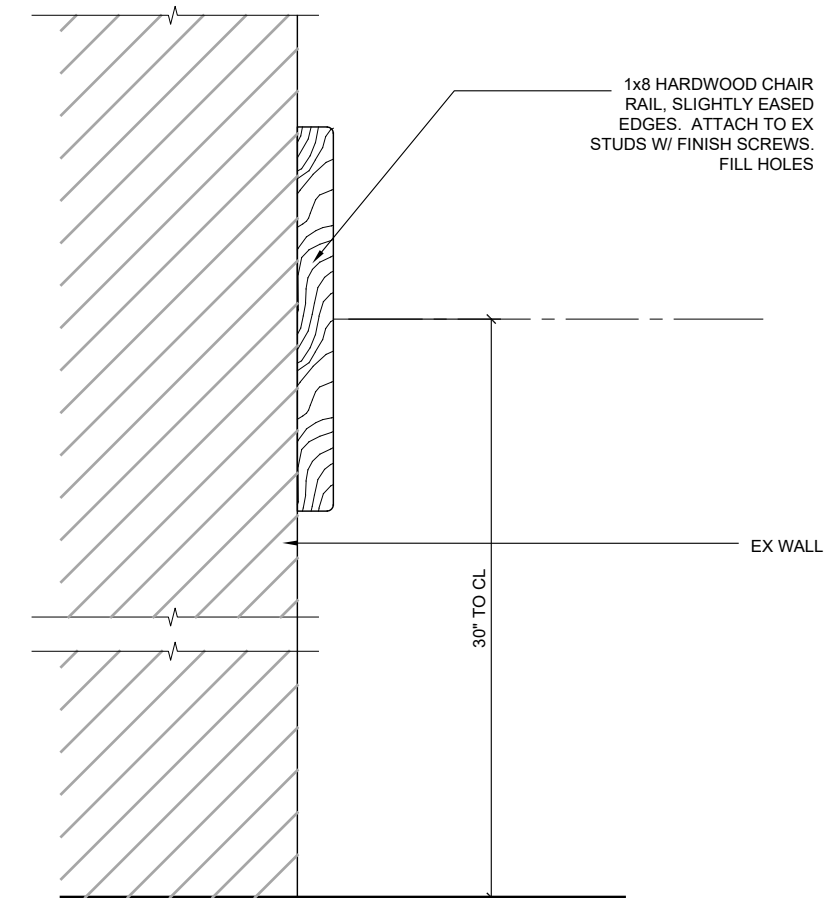

3 CHAIR RAIL
20014/A901-5 SCALE: 0 3" 6"

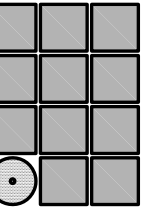

Jensen
Yorba
Wall Inc.

522 West 10th Street
Juneau, Alaska 99801
907.586.1070
AECC137
jensenyorbawall.com

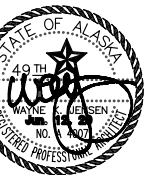

City & Borough of Juneau
Douglas Library
MEETING ROOM RENOVATION
Juneau, Alaska
CBJ PROJ. NO. BE 20-259

REVISIONS



SHEET TITLE
**INTERIOR
DETAILS**

DATE: JUNE 1, 2020
FILE: 20014

A901

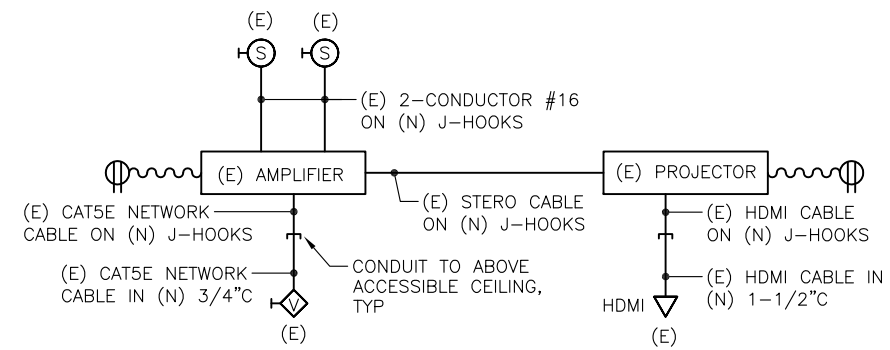

3 AUDIO SYSTEM SINGLE LINE DIAGRAM

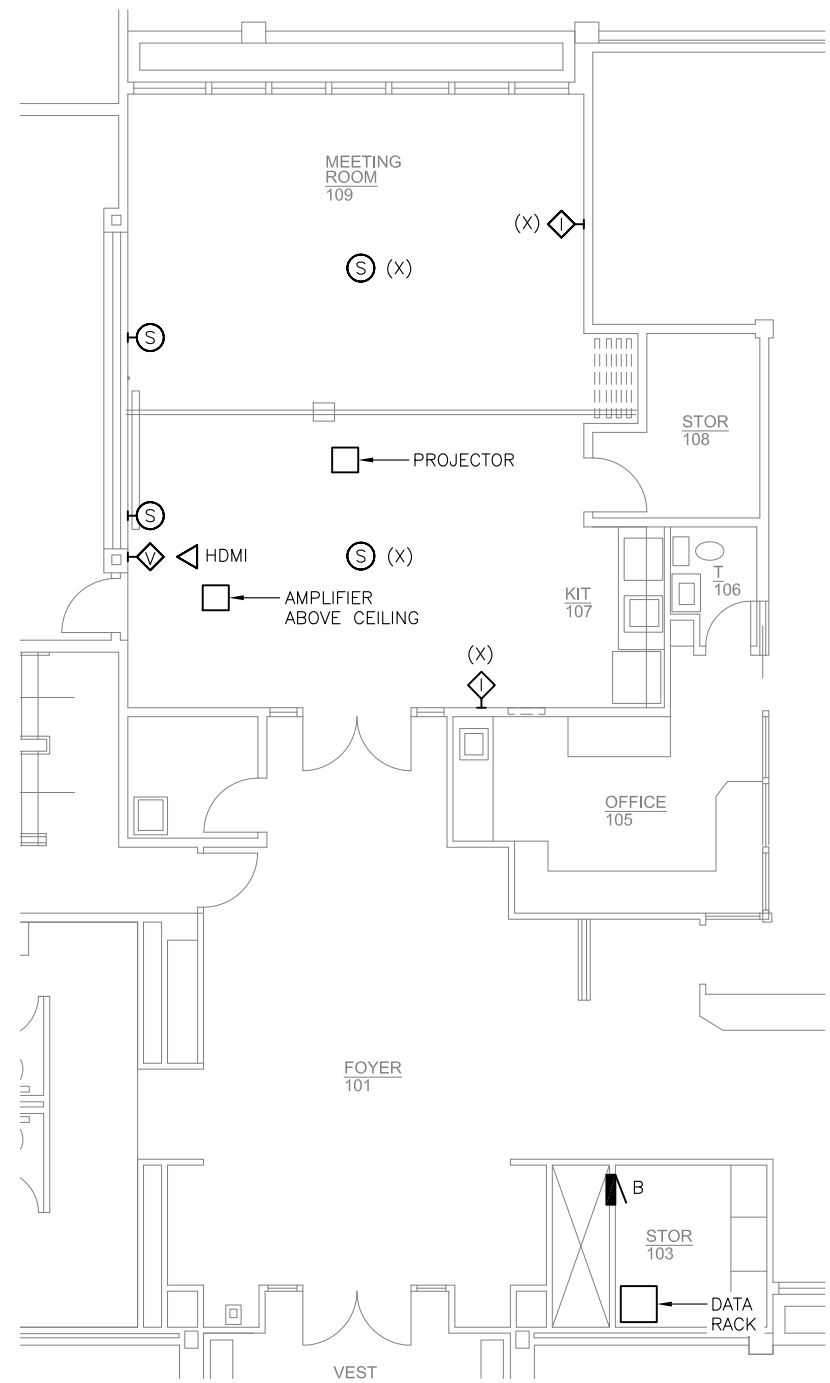

1 ELECTRICAL DEMOLITION PLAN SCALE: 0 2' 4' 8'

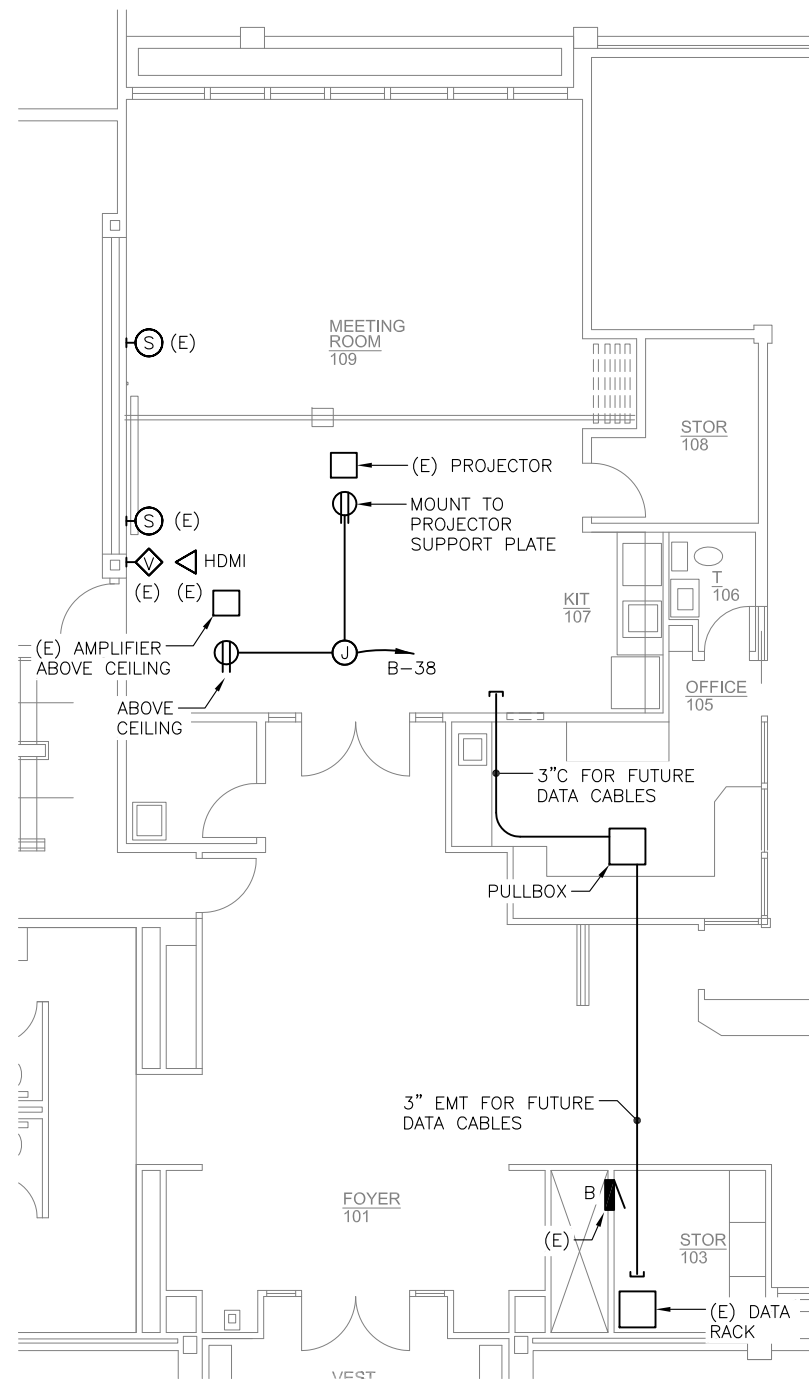

2 ELECTRICAL PLAN SCALE: 0 2' 4' 8'

NOTES:

1. THE EXISTING AUDIO SYSTEM CABLES ARE INSTALLED IN SURFACE MOUNTED RACEWAY AND UN-SUPPORTED ACROSS THE ACCESSIBLE CEILING. DEMOLISH SURFACE MOUNTED RACEWAYS. RE-INSTALL CABLES IN CONCEALED CONDUIT DOWN WALL. MOUNT VOLUME CONTROL AND HDMI CONNECTION IN FLUSH BOXES. PROVIDE J-HOOKS ABOVE ACCESSIBLE CEILING. REFER TO DETAIL 3, AUDIO SINGLE LINE DIAGRAM FOR RACEWAYS AND SUPPORTS.
2. PROVIDE 20/1 CIRCUIT BREAKER FOR BRANCH CIRCUIT B-38.
3. BRANCH CIRCUITS: SINGLE THHN THWN STRANDED CONDUCTORS IN EMT CONDUIT.
4. REMOVE INTERCOM SYSTEM WIRE, CABLE, AND CONDUIT BACK TO POINT OF ORIGIN.
5. PULLBOX: 2'x2'x6", SHEET METAL, GREY PAINT, SCREW COVER.

WIRING

- JUNCTION BOX
- CONDUIT CONCEALED IN CEILING OR WALL
- HOT CONDUCTOR
- NEUTRAL CONDUCTOR
- GROUND CONDUCTOR
- HOMERUN TO INDICATED DESTINATION
- FLEXIBLE CONDUIT CONNECTION

NOTE: WIRING NOT SHOWN WHERE ONLY A HOT, NEUTRAL, AND GROUND ARE REQUIRED.

POWER DEVICES

- DUPLEX RECEPTACLE

DISTRIBUTION

- BRANCH CIRCUIT PANELBOARD

SIGNAL

- DATA OUTLET
- SPEAKER
- INTERCOM STATION
- VOLUME CONTROL

REFERENCE SYMBOLS

- 1 E201 DETAIL REFERENCE
- (E) EXISTING
- (N) NEW
- (X) DEMOLISH

ABBREVIATIONS

- AWG AMERICAN WIRE GAUGE
- C CONDUIT
- EMT ELECTRICAL METALLIC TUBING
- G GROUND

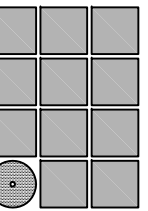

Jensen
Yorba
Wall Inc.



City & Borough of Juneau
 Douglas Library
MEETING ROOM RENOVATION
 Juneau, Alaska
 CBJ PROJ. NO. BE 20-259

REVISIONS

-
-
-

SHEET TITLE
ELECTRICAL PLANS

DATE: JUNE 1, 2020
FILE: 20014

E201