

BARTLETT REGIONAL HOSPITAL MRI & CT REPLACEMENT

Contract No. BE23-042

File No. 2152



SECTION 00005 - TABLE OF CONTENTS

DIVISION 0 - BIDDING AND CONTRACT REQUIREMENTS, CONTRACT FORMS, AND CONDITIONS OF THE CONTRACT

BIDDING and CONTRACT REQUIREMENTS		No. of Pages
00005	Table of Contents	4
00030	Notice Inviting Bids	2
00100	Instructions to Bidders	10
00300	Bid	2
00310	Bid Schedule	1
00320	Bid Bond	1
00360	Subcontractor Report.....	2
00360	Contractor Financial Responsibility.....	3

CONTRACT FORMS

00500	Agreement	6
00610	Performance Bond	2
00620	Payment Bond	2

CONDITIONS OF THE CONTRACT

00700	General Conditions	44
00800	Supplementary General Conditions	5
00830	Alaska Labor Standards, Reporting, and Prevailing Wage Rate Determination.....	1
	Appendix A – Pamphlet 600 – Effective April 1, 2022.....	40

DIVISION 1 - GENERAL REQUIREMENTS

011000	Summary.....	4
012300	Alternates.....	2
012500	Substitution Procedures	4
012600	Contract Modification Procedures	2
012900	Payment Procedures.....	2
013100	Project Management and Coordination.....	7
013200	Construction Progress Documentation.....	4
013300	Submittal Procedures	7
014000	Quality Requirements	6
014200	References	2
015000	Temporary Facilities and Controls.....	6
015220	Security.....	1
015221A	Special Safety Requirements	3
015221B	Infection Control for Construction and Renovation.....	14
015221C	Personnel Immunization Requirments	3
016000	Product Requirements.....	5
017300	Execution.....	6
017700	Closeout Requirements.....	10
017823	Operation and Maintenance Data.....	7
017839	Project Record Documents	3

SECTION 00005 - TABLE OF CONTENTS

DIVISION 2 – EXISTING CONDITIONS

024119 Selective Demolitions 7

DIVISION 3 – CONCRETE

033000 Cast-In-Place Concrete 9

DIVISION 7 – THERMAL AND MOISTURE PROTECTION

072100 Thermal Insulation..... 3
072600 Vapor Retarders..... 2
079200 Joint Sealants 6

DIVISION 8 – OPENINGS

081213 Hollow Metal Frames 6
081416 Flush Wood Doors..... 4
083213 Sliding Aluminum-Framed Glass Doors..... 6
087100 Door Hardware 12
089119 Fixed Louvers..... 6

DIVISION 9 – FINISHES

092216 Non-Structural Metal Framing..... 4
092900 Gypsum Board..... 6
095113 Acoustical Panel Ceilings 6
096513 Resilient Base and Accessories..... 4
096516 Resilient Sheet Flooring..... 6
099123 Interior Painting..... 4

DIVISION 10 – SPECIALTIES

102600 Wall and Door Protection 4

DIVISION 20 - MECHANICAL

200000 Mechanical General Requirements 20
200513 Common Motor Requirments 8
200529 Mechanical Hangers and Supports..... 12
200553 Mechanical Identification 6
200700 Mechanical Insulation 8
204100 Mechanical Demolition..... 6

DIVISION 22 - PLUMBING

221100 Domestic Water Piping and Specialties 8
221300 Sanitary Waste and Vent Piping and Specialties 6

SECTION 00005 - TABLE OF CONTENTS

DIVISION 23 – HEATING, VENTILATION AND AIR CONDITIONING (HVAC)

230593	Testing, Adjusting and Balancing.....	8
232113	Hydronic Piping and Specialties	16
233100	Ducts and Accessories	10
233700	Air Outlets and Inlets.....	4
236400	Packaged Water Chillers	10
238200	Terminal Heating and Cooling Units.....	6

DIVISION 25 – INTEGRATED AUTOMATION

259000	Sequence of Operations	4
--------	------------------------------	---

DIVISION 26 - ELECTRICAL

260000	Electrical General Requirements	20
260519	Low Voltage Electrical Power Conductors and Cables	6
260526	Grounding and Bonding for Electrical Systems	8
260529	Hangers and Supports for Electrical Systems	8
260533	Raceway and Boxes for Electrical Systems	14
260553	Identification for Electrical Systems	8
262416	Panelboards.....	5
262726	Wiring Devices.....	4
262800	Low Voltage Circuit Protective Devices	4
262900	Low Voltage Controllers.....	4
265000	Lighting Fixtures	4

DIVISION 27 - COMMUNICATIONS

270536	Cable Trays	8
--------	-------------------	---

APPENDIX A

MRI Shielding	6
CT Room 1 Radiation Shielding	10
CT Room 1361 Radiation Shielding	10

SECTION 00005 - TABLE OF CONTENTS

DRAWINGS

G100	COVER SHEET
G101	GENERAL NOTES, ABBREVIATIONS, LOCATION MAP AND SHEET INDEX
G102	MRI TRAILER SITE PLAN
LS101	LIFE SAFETY PLAN
D101	OVERALL & PHASING DEMOLITION PLAN
D102	DEMOLITION PLAN - CT 1314A
D103	DEMOLITION PLAN - CT 1361
D104	DEMOLITION PLAN - MRI 1358
D201	DEMOLITION EXTERIOR ELEVATION
A101	OVERALL & PHASING FLOOR PLAN
A102	NEW PLAN - CT 1314A
A103	NEW PLAN - CT 1361
A104	NEW PLAN - MRI 1358
A105	FLOOR FINISH PLAN
A106	ALTERNATE REFLECTED CEILING PLAN
A201	EXTERIOR ELEVATIONS
A301	BUILDING SECTIONS & DETAILS
A501	DETAILS
S101	STRUCTURAL GENERAL NOTES AND DETAILS
S102	STRUCTURAL DETAILS
M001	LEGEND, ABBREVIATIONS & SCHEDULES
M101	MECHANICAL OVERALL
M201	ENLARGED PLAN - MECHANICAL- CT RM 1314 - DEMO AND NEW
M202	ENLARGED PLAN - MECHANICAL- CT RM 1361, MRI 1358 - DEMO AND NEW
M601	DETAILS AND DIAGRAMS
M602	DETAILS AND DIAGRAMS
E001	LEGEND AND ABBREVIATIONS
E002	SCHEDULES - CT ROOM 1314
E003	SCHEDULES - CT ROOM 1316
E004	SCHEDULES - MRI 1358
E100	SITE PLAN
E101	OVERALL PLAN
E201	ENLARGED PLAN - LIGHTING - CT RM 1314 - DEMO AND NEW
E202	ENLARGED PLAN - POWER AND SPECIAL SYSTEMS - CT RM 1314 - DEMO
E203	ENLARGED PLAN - POWER AND SPECIAL SYSTEMS - CT RM 1314 - NEW
E301	ENLARGED PLAN - LIGHTING - CT RM 1316 - DEMO AND NEW
E302	ENLARGED PLAN - POWER AND SPECIAL SYSTEMS - CT RM 1316 - DEMO
E303	ENLARGED PLAN - POWER AND SPECIAL SYSTEMS - CT RM 1316 - NEW
E401	ENLARGED PLAN - LIGHTING - MRI 1358 - DEMO AND NEW
E402	ENLARGED PLAN - POWER AND SPECIAL SYSTEMS - MRI 1358 - DEMO
E403	ENLARGED PLAN - POWER AND SPECIAL SYSTEMS - MRI 1358 - NEW
E501	ENLARGED PLAN - ELEC AND TELECOM ROOMS
E601	DETAILS - MOBILE MRI CONNECTION
E701	PARTIAL POWER ONE-LINE

END OF SECTION

SECTION 00030 NOTICE INVITING BIDS

OBTAINING CONTRACT DOCUMENTS. The Contract Documents are entitled:

**Bartlett Regional Hospital MRI & CT Replacement
Contract No. BE23-042**

The Contract Documents may be downloaded from the CBJ Public Purchase webpage at <https://www.publicpurchase.com/juneau.ak>. Instructions for the Public Purchase registration process can be found at <https://juneau.org/engineering-public-works/bids-rfps>.

PRE-BID CONFERENCE. Prospective Bidders are encouraged to attend a Pre-Bid conference to discuss the proposed WORK, which will be conducted by the OWNER, at 9:00 a.m. on July 25, 2022 at Bartlett Regional Hospital. The object of the conference is to acquaint Bidders with the project location and bid documents. Conference call capability will be available for the Pre-Bid meeting. Bidders intending to participate shall notify Cristian Crabtree in the CBJ Engineering Contracts Division, at Contracts@juneau.org by 4:30 p.m., July 22, 2022.

DESCRIPTION OF WORK. This Project consists of the work required to facilitate the replacement of three (3) medical imaging modalities including two (2) CT scanners and one (1) MRI. This works includes the addition of new chiller to cool the equipment, equipment screen, replacement of interior finishes as necessary, and the necessary infrastructure to support a temporary MRI trailer during construction operations.

There are no modifications proposed to egress, construction classification, use, occupancy, building area, or rated assemblies.

The contractor, as a delegated design, shall address the fire alarm system, automatic sprinkler system, RF shielding, and Magnetic Shielding. The Work shall be phased; See Sheet D101 and A101 in The Drawings.

ARCHITECT’S ESTIMATE RANGE: \$1,200,000 to \$1,500,000.

COMPLETION OF WORK.

<u>Work Description</u>	<u>Completion Date</u>
Substantial Completion – Phase I*	July 18, 2023
Final Completion – Phase I	30 days after substantial completion
Substantial Completion – Phase II	December 8, 2023
Final Completion – Phase II	30 days after substantial completion

*Subject to change due to supply chain issues with critical equipment.

DEADLINE FOR BIDDER QUESTIONS: 4:30pm Alaska Time on July 29, 2022.

DEADLINE FOR BIDS: Electronic bids must be received by the Purchasing Division **prior to 2:00 p.m., Alaska Time on August 5, 2022** or such later time as may be announced by addendum at any time prior to the deadline. Bids will be opened immediately thereafter via conference call, unless otherwise specified. Bidders may attend this bid opening on the conference call line 907-713-2140, with participant code 258358.

SUBMISSION INSTRUCTIONS: Timely responses are accepted via Electronic Submission at Public Purchase, www.publicpurchase.com, the CBJ’s eProcurement Provider. Bidders must register online prior to submitting a bid, it may take up to 24 hours for registration to be complete.

SECTION 00030 NOTICE INVITING BIDS

Late responses will not be accepted.

To Respond, Bidders must complete an online registration.

- Registration is a two-step process, registering with Public Purchase, and then registering with CBJ within Public Purchase.
- Get help registering using the [Public Purchase](#) Help Menu Tab.
- Register early to avoid missing the deadline, as Registration may take up to 24 hours to complete.

Registered Bidders may submit a Bid Schedule to Public Purchase by downloading the provided PDF solicitation documents, filling out the fields indicated, and uploading the document to Public Purchase.

SITE OF WORK. The site of the WORK is the Bartlett Regional Hospital.

BIDDING, CONTRACT, or TECHNICAL QUESTIONS. All communications relative to this WORK, prior to opening Bids, shall be directed to the following:

Caleb Comas, Contract Administrator
CBJ Engineering Department, 3rd Floor, Marine View Center
Email: caleb.comas@juneau.org
Telephone: (907) 586-0800 ext. 4196
Fax: (907) 586-4530

BID SECURITY. Each Bid shall be accompanied by a certified or cashier's check or Bid Bond, in the amount of 5% percent of the Bid, payable to the City and Borough of Juneau, Alaska, as a guarantee that the Bidder, if its Bid is accepted, will promptly execute the Agreement. A Bid shall not be considered unless one of the forms of Bidder's security is provided as described in Section 00100, Article 12, at the time of bid.

CONTRACTOR'S LICENSE. All contractors are required to have a current Alaska Contractor's License, prior to submitting a Bid, and a current Alaska Business License prior to award.

BID TO REMAIN OPEN. The Bidder shall guarantee the Bid for a period of 45 Days from the date of Bid opening. Any component of the Bid including additive alternates may be awarded anytime during the 45 Days.

OWNER'S RIGHTS RESERVED. The OWNER reserves the right to reject any or all Bids, to waive any informality in a Bid, and to make award to the lowest responsive, responsible Bidder as it may best serve the interests of the OWNER.

OWNER: City and Borough of Juneau

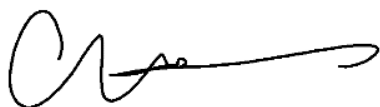
By: 
Caleb Comas, Contract Administrator

7/15/22
Date

END OF SECTION

SECTION 00100 - INSTRUCTIONS TO BIDDERS

1.0 DEFINED TERMS. Terms used in these Instructions to Bidders and the Notice Inviting Bids, which are defined in the General Conditions, have the meanings assigned to them in the General Conditions. The term "Bidder" means one who submits a Bid directly to the OWNER, as distinct from a sub-bidder, who submits a Bid to a Bidder.

2.0 INTERPRETATIONS AND ADDENDA.

- A. **INTERPRETATIONS.** All questions about the meaning or intent of the Contract Documents are to be directed to the Engineering Contracts Administrator. Interpretations or clarifications considered necessary by the Engineering Contracts Administrator in response to such questions will be issued by Addendum, mailed, faxed, or delivered to all parties recorded by the Engineering Contracts Administrator, or OWNER, as having received the Contract Documents. Questions received less than seven Days prior to the Deadline for Bids may not be answered. Only questions answered by formal written Addendum will be binding. Oral and other interpretations or clarifications will be without legal effect.
- B. **ADDENDA.** Addenda may be issued to modify the Contract Documents as deemed advisable by the OWNER. Addenda may be faxed or, if addendum format warrants, addenda may be posted to the CBJ Engineering Department website. In any event, notification of addendum issuance will be faxed to planholders. Hard copies are available upon request. The OWNER will make all reasonable attempts to ensure that all planholders receive notification of Addenda, however, it is strongly recommended by the OWNER that bidders independently confirm the contents, number, and dates of each Addendum prior to submitting a Bid.

3.0 FAIR COMPETITION. More than one Bid from an individual, firm, partnership, corporation, or association under the same or different names will not be considered. If the OWNER believes that any Bidder is interested in more than one Bid for the WORK contemplated, all Bids in which such Bidder is interested will be rejected. If the OWNER believes that collusion exists among the Bidders, all Bids will be rejected.

4.0 RESPONSIBILITY OF BIDDERS. Only responsive Bids from responsible Bidders will be considered. A Bid submitted by a Bidder determined to be not responsible may be rejected. The OWNER may find a bidder to be not responsible for any one of the following reasons, but is not limited in its responsibility analysis to the following factors:

- A. Evidence of bid rigging or collusion;
- B. Fraud or dishonesty in the performance of previous contracts;
- C. Record of integrity;
- D. More than one bid for the same work from an individual, firm, or corporation under the same or different name;
- E. Unsatisfactory performance on previous or current contracts;
- F. Failure to pay, or satisfactorily settle, all bills due for labor and material on previous contracts;

SECTION 00100 - INSTRUCTIONS TO BIDDERS

- G. Uncompleted work that, in the judgment of the OWNER, might hinder or prevent the bidder's prompt completion of additional work, if awarded;
- H. Failure to reimburse the OWNER for monies owed on any previous contracts;
- I. Default under previous contracts;
- J. Failure to comply with any qualification requirements of the OWNER; special standards for responsibility, if applicable, will be specified. These special standards establish minimum standards or experience required for a responsible Bidder on a specific contract;
- K. Engaging in any activity that constitutes a cause for debarment or suspension under the CBJ Procurement Code 53.50 or submitting a bid during a period of debarment;
- L. Lack of skill, ability, financial resources, or equipment required to perform the contract.
- M. Lack of legal capacity to contract.
- N. Bidders must be registered as required by law and in good standing for all amounts owed to the OWNER per Paragraph 21.0 of this Section.
- O. Failure to submit all completed documents as required and specified on the Bid Form, Section 00300.

Nothing contained in this section deprives the OWNER of its discretion in determining the lowest responsible bidder. Before a Bid is considered for award, a Bidder may be requested to submit information documenting its ability and competency to perform the WORK, according to general standards of responsibility and any special standards which may apply. It is Bidder's responsibility to submit sufficient, relevant, and adequate information. OWNER will make its determination of responsibility and has no obligation to request clarification or supplementary information.

5.0 NON-RESPONSIVE BIDS. Only responsive Bids will be considered. Bids may be considered non-responsive and may be rejected. Some of the reasons a Bid may be rejected for being non-responsive are:

- A. If a Bid is received by the CBJ Purchasing Division after the Deadline for Bids.
- B. If the Bid is on a form other than that furnished by the OWNER, or legible copies thereof; or if the form is altered or any part thereof is detached; or if the Bid is improperly signed.
- C. If there are unauthorized additions, conditional or alternate Bids, or irregularities of any kind which may tend to make the bid incomplete, indefinite, ambiguous as to its meaning, or in conflict with the OWNER's Bid document.
- D. If the Bidder adds any unauthorized conditions, limitations, or provisions reserving the right to accept or reject any award, or to enter into a contract pursuant to an award. This does not exclude a Bid limiting the maximum gross amount of awards acceptable to any one Bidder at any one Bid opening, provided that any selection of awards will be made by the OWNER.
- E. If the Bid does not contain a Unit Price for each pay item listed, except in the case of

SECTION 00100 - INSTRUCTIONS TO BIDDERS

authorized alternate pay items.

- F. If the Bidder has not acknowledged receipt of each Addendum.
- G. If the Bidder fails to furnish an acceptable Bid guaranty with the Bid.
- H. If any of the Unit Prices Bid are excessively unbalanced (either above or below the amount of a reasonable Bid) to the potential detriment of the OWNER.
- I. If a Bid modification does not conform to Article 15.0 of this Section.
- J. Failure to submit all completed documents as required and specified on the Bid Form, Section 00300.

6.0 BIDDER'S EXAMINATION OF CONTRACT DOCUMENTS AND SITE. It is the responsibility of each Bidder before submitting a Bid:

- A. To examine thoroughly the Contract Documents, and other related data identified in the Bidding documents (including "technical data" referred to below):
 - 1. To visit the site to become familiar with and to satisfy the Bidder as to the general and local conditions that may affect cost, progress, or performance, of the WORK,
 - 2. To consider federal, state and local laws and regulations that may affect cost, progress, or performance of the WORK,
 - 3. To study and carefully correlate the Bidder's observations with the Contract Documents, and other related data; and
 - 4. To notify the ARCHITECT of all conflicts, errors, or discrepancies in or between the Contract Documents and such other related data.

7.0 REFERENCE IS MADE TO THE SUPPLEMENTARY GENERAL CONDITIONS FOR IDENTIFICATION OF:

- A. Those reports of explorations and tests of subsurface conditions at the site which have been utilized by the Architect of Record in the preparation of the Contract Documents. The Bidder may rely upon the accuracy of the technical data contained in such reports, however, the interpretation of such technical data, including any interpolation or extrapolation thereof, together with non-technical data, interpretations, and opinions contained therein or the completeness thereof is the responsibility of the Bidder.
- B. Those Drawings of physical conditions in or relating to existing surface and subsurface conditions (except underground utilities) which are at or contiguous to the site have been utilized by the Architect of Record in the preparation of the Contract Documents. The Bidder may rely upon the accuracy of the technical data contained in such Drawings, however, the interpretation of such technical data, including any interpolation or extrapolation thereof, together with nontechnical data, interpretations, and opinions contained in such Drawings or the completeness thereof is the responsibility of the Bidder.
- C. Copies of such reports and Drawings will be made available by the OWNER to any Bidder on request if said reports and Drawings are not bound herein. Those reports and Drawings are not part of the Contract Documents, but the technical data contained therein upon

SECTION 00100 - INSTRUCTIONS TO BIDDERS

which the Bidder is entitled to rely, as provided in Paragraph SGC-4.2 of the Supplementary General Conditions, are incorporated herein by reference.

- D. Information and data reflected in the Contract Documents with respect to underground utilities at or contiguous to the site is based upon information and data furnished to the OWNER and the Architect of Record by the owners of such underground utilities or others, and the OWNER does not assume responsibility for the accuracy or completeness thereof unless it is expressly provided otherwise in the Supplementary General Conditions, or in Section 01530 - Protection and Restoration of Existing Facilities of the General Requirements.
- E. Provisions concerning responsibilities for the adequacy of data furnished to prospective Bidders on subsurface conditions, underground utilities and other physical conditions, and possible changes in the Contract Documents due to differing conditions appear in Paragraphs 4.2, 4.3, and 4.4 of the General Conditions.
- F. Before submitting a Bid, each Bidder will, at Bidder's own expense, make or obtain any additional examinations, investigations, explorations, tests, and studies and obtain any additional information and data which pertain to the physical conditions (surface, subsurface, and underground utilities) at or contiguous to the site or otherwise which may affect cost, progress, or performance of the WORK and which the Bidder deems necessary to determine its Bid for performing the WORK in accordance with the time, price, and other terms and conditions of the Contract Documents.
- G. On request in advance, the OWNER will provide each Bidder access to the site to conduct such explorations and tests as each Bidder deems necessary for submission of a Bid. Bidder shall fill all holes and shall clean up and restore the site to its former condition upon completion of such explorations.
- H. The lands upon which the WORK is to be performed, rights-of-way and easements for access thereto and other lands designated for use by the CONTRACTOR in performing the WORK are identified in the Contract Documents. All additional lands and access thereto required for temporary construction facilities or storage of materials and equipment are to be provided by the CONTRACTOR. Easements for permanent structures or permanent changes in existing structures are to be obtained and paid for by the OWNER unless otherwise provided in the Contract Documents.
- I. The submission of a Bid will constitute an incontrovertible representation by the Bidder that the Bidder has complied with every requirement of Article 6.0, "Bidder's Examination of Contract Documents and Site" herein, that without exception the Bid is premised upon performing the WORK required by the Contract Documents and such means, methods, techniques, sequences, or procedures of construction as may be indicated in or required by the Contract Documents, and that the Contract Documents are sufficient in scope and detail to indicate and convey understanding of all terms and conditions for performance of the WORK.

8.0 BID FORM.

- A. The Bid shall be made on the Bid Schedule(s) bound herein, or by another acceptable submission method as specified in Section 00030, Notice Inviting Bids, and shall contain the following: Sections 00300, 00310 or other specified acceptable form of Bid Schedule,

SECTION 00100 - INSTRUCTIONS TO BIDDERS

the required Bid Security, and any other documents required in Section 00300 – Bid.

- B. All blanks on the Bid Form and Bid Schedule must be completed in ink or typed.
- C. Bids by corporations must be executed in the corporate name by the president, a vice-president (or other corporate officer). The corporate address and state of incorporation must appear below the signature.
- D. Bids by partnerships must be executed in the partnership name and be signed by a managing partner, and the official address of the partnership must appear below the signature.
- E. The Bidder's Bid must be signed. All names must be printed or typed below the signature.
- F. The Bid shall contain an acknowledgment of receipt of all Addenda, the numbers of which shall be filled in on the Bid form. Failure to acknowledge Addenda may render Bid non-responsive and may cause its rejection.
- G. The address to which communications regarding the Bid are to be directed must be shown.

9.0 QUANTITIES OF WORK. The quantities of WORK, or material, stated in Unit Price items of the Bid are supplied only to give an indication of the general scope of the WORK; the OWNER does not expressly or by implication agree that the actual amount of WORK, or material, will correspond therewith, and reserves the right after award to increase or decrease the amount of any Unit Price item of the WORK by an amount up to and including 25 percent of any Bid item, without a change in the Unit Price, and shall include the right to delete any Bid item in its entirety, or to add additional Bid items up to and including an aggregate total amount not to exceed 25 percent of the Contract Price (see Section 00700 - General Conditions, Article 10 Changes In the WORK).

10.0 SUBSTITUTE OR "OR-EQUAL" ITEMS. Substitution requests are not accepted during the bidding process. The procedure for the submittal of substitute or "or-equal" products is specified in Section 013300 – Submittal Procedures.

11.0 SUBMISSION OF BIDS. The Bid shall be delivered by the time and to the place stipulated in Section 00030 - Notice Inviting Bids. It is the Bidder's sole responsibility to see that its Bid is received in proper time. Hand-delivered, mailed, courier-delivered, oral, telegraphic, emailed, or faxed Bids will not be considered.

12.0 BID SECURITY, BONDS, AND INSURANCE. Each Bid shall be accompanied by a certified, or cashier's check, or approved Bid Bond in an amount of at least 5 percent of the total Bid price. The "total Bid price" is the amount of the Base Bid, plus the amount of alternate Bids, if any, which total to the maximum amount for which the CONTRACT could be awarded. Said check or Bond shall be made payable to the OWNER and shall be given as a guarantee that the Bidder, if offered the WORK, will enter into an Agreement with the OWNER, and will furnish the necessary insurance certificates, Payment Bond, and Performance Bond; each of said Bonds, if required, and insurance amounts shall be as stated in the Supplementary General Conditions. In case of refusal or failure to enter into said Agreement, the check or Bid Bond, as the case may be, may be forfeited to the OWNER. If the Bidder elects to furnish a Bid Bond as its Bid security, the Bidder shall use the Bid Bond form bound herein, or one conforming substantially to it in form. Bid Bonds must be accompanied by a legible Power of Attorney.

SECTION 00100 - INSTRUCTIONS TO BIDDERS

Bid Bonds shall be submitted by being scanned and uploaded to Public Purchase along with the other required Bid documents. When a Bid security check is used, it must be received by the Purchasing Division prior to the Deadline for Bids. Bid security checks will be time and date stamped by the Purchasing Division, which will establish the official time of receipt.

In addition to uploading a scanned file of the Bid Bond, the original hardcopy Bid Bond shall be submitted and received by the CBJ Contracts Office by 2:00 p.m. Alaska Time no more than seven calendar days after Bid Opening.

In lieu of the original hardcopy Bid Bond submittal requirement, bidders who have a Surety 2000 Bid Bond ID may validate their Bid Bond with Surety 2000 within the Bid Bond Response Information Form in the Public Purchase bid page.

Bid security checks shall be submitted in a sealed envelope that clearly indicates: that a bid security check is enclosed, the name of the bidding firm, and the project name and number. The envelope must not reveal the check amount so that the final Bid price will not be known until the sealed bids are opened.

Bid security checks delivered **in person** or by **courier** service must be delivered to:

Bid security checks delivered by **U.S. Postal Service** must be mailed to:

PHYSICAL LOCATION:

City and Borough of Juneau, Purchasing Division
105 Municipal Way, Room 300
Juneau, AK 99801

MAILING ADDRESS:

City and Borough of Juneau, Purchasing Division
155 South Seward Street
Juneau, AK 99801

Mailing/delivery times to Alaska may take longer than other areas of the U.S. Late bid security checks may cause a Bid to be deemed non-responsive.

13.0 RETURN OF BID SECURITY. The OWNER will return all Bid security checks (certified or cashier's) accompanying such of the Bids as are not considered in making the award. All other Bid securities will be held until the Agreement has been executed. Following execution of the Agreement, all other Bid security checks will be returned to the respective Bidders whose Bids they accompanied and Bid security bonds will be appropriately discarded.

14.0 DISCREPANCIES IN BIDS. In the event there is more than one Pay Item in a Bid Schedule, the Bidder shall furnish a price for all Pay Items in the schedule, and failure to do so may render the Bid non-responsive and cause its rejection. In the event there are Unit Price Pay Items in a Bid Schedule and the "amount" indicated for a Unit Price Bid Item does not equal the product of the Unit Price and quantity, the Unit Price shall govern and the amount will be corrected accordingly, and the Bidder shall be bound by said correction. In the event there is more than one Pay Item in a Bid Schedule and the total indicated for the schedule does not agree with the sum of the prices Bid on the individual items, the prices Bid on the individual items shall govern and the total for the schedule will be corrected accordingly, and the Bidder shall be bound by said correction.

15.0 BID MODIFICATIONS AND UNAUTHORIZED ALTERNATIVE BIDS.

- A. Any bidder may deliver a modification to a bid in person, by mail or fax (907-586-4561), provided that such modification is received by the Purchasing Division no later than the

SECTION 00100 - INSTRUCTIONS TO BIDDERS

deadline for bids. Modifications will be time and date stamped by the Purchasing Division, which will establish the official time of receipt of the modification. The modification must not reveal the bid price but should be in the form of an addition or subtraction or other modification so that the final prices will not be known until the sealed bid is opened.

The Bid modifications shall be provided on the **Bid Modification Form** located at the end of this Section. Submittal of any other form by the vendor may deem the modification unacceptable by the OWNER. **A mail or fax modification should not reveal the Bid price but should provide the addition or subtraction or other modification so that the final prices will not be known by the City and Borough until the sealed Bid is opened.** Submitted Modification forms shall include the modification to the unit price or lump sum amount of each pay item modified.

FAX DISCLAIMER: It is the responsibility of the bidder to submit modifications in a timely manner. Bidders' use of a fax machine to modify their bid shall be at bidders' sole risk. The Purchasing Division will attempt to keep the fax machine in good working order but will not be responsible for bid modifications that are late due to mechanical failure, a busy fax machine, or any other cause arising from bidder's use of a fax machine, even if bidder submits a transmission report or provides other confirmation indicating that the bidder transmitted a bid modification prior to the deadline. The City will not be responsible for its failure to receive the modification whether such failure is caused by equipment or human error, or otherwise. Bidders are therefore strongly encouraged to confirm receipt of their bid modification with the Purchasing Division (907-586-5215) prior to deadline.

- B. Conditioned bids, limitations, or provisos attached to the Bid or bid modification will render it unauthorized and cause its rejection as being non-responsive. The completed Bid forms shall be without interlineations, alterations, or erasures in the printed text. All changes shall be initialed by the person signing the Bid. Alternative Bids will not be considered unless called for.

16.0 WITHDRAWAL OF BID. Prior to the Deadline for Bids, the Bid may be withdrawn by the Bidder by means of a written request, signed by the Bidder or its properly authorized representative. Such written request must be delivered to the place stipulated in the Notice Inviting Bids for receipt of Bids.

17.0 AWARD OF CONTRACT.

- A. Award of a contract, if it is awarded, will be on the basis of materials and equipment described in the Drawings or specified in the Technical Specifications and will be made to the lowest responsive, responsible Bidder whose Bid complies with all the requirements prescribed. Unless otherwise specified, any such award will be made within the period stated in the Notice Inviting Bids that the Bids are to remain open. Unless otherwise indicated, a single award will be made for all the Bid items in an individual Bid Schedule.
- B. If the OWNER has elected to advertise this Project with a Base Bid and Alternates, the OWNER may elect to award the contract for the Base Bid, or the Base Bid in combination with one or more Alternates selected by the OWNER. In either case, award shall be made to the responsive, responsible bidder offering the lowest total Bid for the WORK to be awarded.

SECTION 00100 - INSTRUCTIONS TO BIDDERS

- C. Low Bidder will be determined on the basis of the lowest total of the Base Bid plus combinations of Alternates in order of priority as listed below within the limits of available funding.

Priority No.

1. Alternate Reflected Ceiling Plan

- D. Award of a contract is subject to the adoption of an appropriation of funds by the City Assembly.

18.0 EXECUTION OF AGREEMENT.

- A. All Bids of value greater than \$1,000,000 must be approved by the CBJ Assembly. After the CBJ Assembly has approved the award and after the Bid protest period, the OWNER will issue a Notice of Intent to Award to the approved Bidder. The Bidder to whom award is made shall execute a written Agreement with the OWNER on the Agreement form, Section 00500, collect insurance, and shall furnish all certificates and Bonds required by the Contract Documents within 10 Days (calendar) from the date of the Notice of Intent to Award letter.
- B. Failure or refusal to enter into the Agreement as herein provided or to conform to any of the stipulated requirements in connection therewith shall be just cause for annulment of the award and forfeiture of the Bid security. If the lowest responsive, responsible Bidder refuses or fails to execute the Agreement, the OWNER may award the contract to the second lowest responsive, responsible Bidder. If the second lowest responsive, responsible Bidder refuses or fails to execute the Agreement, the OWNER may award the contract to the third lowest responsive, responsible Bidder. On the failure or refusal of such second or third lowest Bidder to execute the Agreement, each such Bidder's Bid securities shall be likewise forfeited to the OWNER.

19.0 **LIQUIDATED DAMAGES.** Provisions for liquidated damages if any, are set forth in Section 00500 - Agreement.

20.0 FILING A PROTEST.

- A. A Bidder may protest the proposed award of a competitive sealed Bid by the City and Borough of Juneau. The protest shall be executed in accordance with CBJ Ordinance 53.50.062 PROTESTS and CBJ Ordinance 53.50.080 ADMINISTRATION OF PROTEST. The entire text of the CBJ Purchasing Ordinance can be accessed at the CBJ website, <http://www.juneau.org/law/code/code.php>, or call the CBJ Purchasing Division at (907) 586-5215 for a copy of the ordinance.
- B. Late protests shall not be considered by the CBJ Purchasing Officer.

21.0 **CONTRACTOR'S GOOD STANDING WITH CBJ FINANCE DEPARTMENT:** Contractors must be in good standing with the CBJ prior to award, and prior to any contract renewals, and in any event no later than seven business days following notification by the CBJ of intent to award. **Good standing** means: all amounts owed to the CBJ are current and the Contractor is not delinquent with respect to any taxes, fees, assessment, or other monies due and

SECTION 00100 - INSTRUCTIONS TO BIDDERS

owed the CBJ, or a Confession of Judgment has been executed and the Contractor is in compliance with the terms of any stipulation associated with the Confession of Judgment, including being current as to any installment payments due; and Contractor is current in all CBJ reporting obligations (such as sales tax registration and reporting and business personal property declarations). Failure to meet these requirements may be cause for rejection of your bid. To determine if your business is in good standing, or for further information, contact the CBJ Finance Department's Sales Tax Division at (907) 586-5215 for sales tax issues, Assessor's Office at (907)586-5215 for business personal property issues, or Collections Division at (907) 586-5215 for all other accounts.

22.0 PERMITS AND LICENSES. The CONTRACTOR is responsible for all WORK associated with meeting any local, state, and/or federal permit and licensing requirements.

SECTION 00100 - INSTRUCTIONS TO BIDDERS

CITY AND BOROUGH OF JUNEAU
PURCHASING DIVISION
FAX NO. 907-586-4561

BID MODIFICATION FORM

Modification Number: _____

Note: All modifications shall be made to the original bid amount(s). If more than one Modification form is submitted by any one bidder, changes from all Modification forms submitted will be combined and applied to the original bid. Changes to the modified Bid amounts will be calculated by the OWNER. Bidder may use multiple modification pages if required.

PAY ITEM DESCRIPTION	MODIFICATION TO LUMP SUM <i>(indicate +/-)</i>
Base Bid	

Base Bid Total Increase or Decrease: \$ _____

ALTERNATE PAY ITEM DESCRIPTION	MODIFICATION TO LUMP SUM <i>(indicate +/-)</i>
Additive Alternate No. 1	

Alternate Total Increase or Decrease: \$ _____

Name of Bidding Firm

Responsible Party Signature

Printed Name (must be an authorized signatory for Bidding Firm)

END OF SECTION

SECTION 00300 - BID

BID TO: THE CITY AND BOROUGH OF JUNEAU

1. The undersigned Bidder proposes and agrees, if this Bid is accepted, to enter into an Agreement with the OWNER on the form included in the Contract Documents (as defined in Article 7 of Section 00500 - Agreement) to perform the WORK as specified or indicated in said Contract Documents entitled

**Bartlett Regional Hospital MRI & CT Replacement
Contract No. BE23-042**

2. Bidder accepts all of the terms and conditions of the Contract Documents, including without limitation those in the "Notice Inviting Bids" and "Instructions to Bidders," dealing with the disposition of the Bid Security.
3. This Bid will remain open for the period stated in the "Notice Inviting Bids" unless otherwise required by law. Bidder will enter into an Agreement within the time and in the manner required in the "Notice Inviting Bids" and the "Instructions to Bidders," and will furnish insurance certificates, Payment Bond, Performance Bond, and any other documents as may be required by the Contract Documents.
4. Bidder has familiarized itself with the nature and extent of the Contract Documents, WORK, site, locality where the WORK is to be performed, the legal requirements (federal, state and local laws, ordinances, rules, and regulations), and the conditions affecting cost, progress or performance of the WORK and has made such independent investigations as Bidder deems necessary.
5. This Bid is genuine and not made in the interest of or on behalf of any undisclosed person, firm or corporation and is not submitted in conformity with any agreement or rules of any group, association, organization or corporation; Bidder has not directly or indirectly induced or solicited any other Bidder to submit a false or sham Bid; Bidder has not solicited or induced any person, firm or corporation to refrain from bidding; and Bidder has not sought by collusion to obtain for itself any advantage over any other Bidder or over OWNER.
6. To all the foregoing, and including all Bid Schedule and information required of Bidder contained in this Bid Form, said Bidder further agrees to complete the WORK required under the Contract Documents within the Contract Time stipulated in said Contract Documents, and to accept in full payment therefore the Contract Price based on the total bid price(s) named in the aforementioned Bid Schedule.
7. Bidder has examined copies of all the Contract Documents including the following Addenda (receipt of all of which is hereby acknowledged by the Undersigned):

Addenda No.	Date Issued	Addenda No.	Date Issued

Give number and date of each Addenda above. Failure to acknowledge receipt of all Addenda may cause the Bid to be non-responsive and may cause its rejection.

SECTION 00300 - BID

8. The Bidder has read this Bid and agrees to the conditions as stated herein by signing its signature in the space provided below.

Dated: _____	Bidder: _____ (Company Name)
Alaska CONTRACTOR's Business License No: _____	By: _____ (Signature)
Alaska CONTRACTOR's License No: _____	Printed Name: _____ Title: _____
Telephone No: _____	Address: _____ (Street or P.O. Box)
Fax No: _____	_____ (City, State, Zip)
E-mail: _____	

9. **TO BE CONSIDERED, ALL BIDDERS MUST COMPLETE AND INCLUDE THE FOLLOWING AT THE TIME OF THE DEADLINE FOR BIDS. MISSING DOCUMENTS WILL DEEM THIS BID NON-RESPONSIVE:**

- Bid, Section 00300 (includes Addenda receipt statement)
- Completed Bid Schedule, Section 00310, or other acceptable form of Bid Schedule as specified in Section 00030, Notice Inviting Bids
- Bid Security (Bid Bond, Section 00320, or by a certified or cashier's check as stipulated in the Notice Inviting Bids, Section 00030)
- **Contractor Financial Responsibility, Section 00370**

10. The apparent low Bidder is required to complete and submit the following documents by 4:30 p.m. on the **fifth business day** following the date of the Posting Notice.

- Subcontractor Report, Section 00360

The apparent low Bidder who fails to submit the completed Subcontractor Report within the time specified in Section 00360 – Subcontractor Report, may be found to be not a responsible Bidder and may be required to forfeit the Bid security. The OWNER may then consider the next lowest Bidder for award of the contract.

11. The successful Bidder will be required to submit, **within ten Days (calendar)** after the date of the “Notice of Intent to Award” letter, the following executed documents:

- Agreement Forms, Section 00500
- Performance Bond, Section 00610
- Payment Bond, Section 00620
- Certificates of Insurance, (CONTRACTOR) Section 00700 and Section 00800

END OF SECTION

SECTION 00310 - BID SCHEDULE

Bid Schedule for construction of **BE23-042, Bartlett Regional Hospital MRI & CT Replacement**, in accordance with the Contract Documents.

BASE BID - Furnish all labor, equipment and materials for the work required to facilitate the replacement of three (3) medical imaging modalities including two (2) CT scanners and one (1) MRI. This work includes the addition of new chiller to cool the equipment, equipment screen, replacement of interior finishes as necessary, and the necessary infrastructure to support a temporary MRI trailer during construction operations and perform all WORK as described in these Contract Documents.

TOTAL BASE BID \$ _____
(Price in Figures)

ADDITIVE ALTERNATE NO. 1 – Alternate Reflected Ceiling Plan – Furnish all labor, equipment and materials and perform all WORK to provide new acoustical ceiling tile and grid, new lighting, and new mechanical grilles in rooms 1314A, 1314B, 1364, 1361, and 1358.

TOTAL ADDITIVE ALTERNATE NO. 1 \$ _____
(Price in Figures)

Date: _____ **Bidder:** _____
(Company Name)

END OF SECTION

SECTION 00320 - BID BOND

KNOW ALL PERSONS BY THESE PRESENTS, that _____
_____ as Principal, and _____
as Surety, are held and firmly bound unto **THE CITY AND BOROUGH OF JUNEAU** hereinafter called
"OWNER," in the sum of _____
_____ dollars, (not less than five percent of the total amount of the Bid) for
the payment of which sum, well and truly to be made, we bind ourselves, our heirs, executors, administrators,
successors, and assigns, jointly and severally, firmly by these presents.

WHEREAS, said Principal has submitted a Bid to said OWNER to perform the WORK required under
the Bid Schedule of the OWNER's Contract Documents entitled

**Bartlett Regional Hospital MRI & CT Replacement
CBJ Contract No. BE23-042**

NOW THEREFORE, if said Principal is awarded a contract by said OWNER and, within the time and
in the manner required in the "Notice Inviting Bids" and the "Instructions to Bidders" enters into a written
Agreement on the form of Agreement bound with said Contract Documents, furnishes the required certificates
of insurance, and furnishes the required Performance Bond and Payment Bond, then this obligation shall be
null and void, otherwise it shall remain in full force and effect. In the event suit is brought upon this bond by
said OWNER and OWNER prevails, said Surety shall pay all costs incurred by said OWNER in such suit,
including a reasonable attorney's fee to be fixed by the court.

SIGNED AND SEALED, this _____ day of _____, 20_____.

(SEAL) _____
(Principal)

(SEAL) _____
(Surety)

By: _____
(Signature)

By: _____
(Signature)

END OF SECTION

SECTION 00360 - SUBCONTRACTOR REPORT

LIST OF SUBCONTRACTORS (AS 36.30.115)

The apparent low Bidder must submit a list of Subcontractors that the Bidder proposes to use in the performance of this contract on the fifth business day following the Posting Notice of Bids. If the fifth day falls on a weekend or holiday, the report is due by close of business on the next business Day following the weekend or holiday. The Subcontractor Report list must include each Subcontractor's name, address, location, evidence of valid Alaska Business License, and valid Alaska Contractor's Registration under AS 08.18. *If no Subcontractors are to be utilized in the performance of the WORK, write in ink or type "NONE" on line (1) below*

<u>SUBCONTRACTOR</u>	¹ AK Contractor <u>License No.</u>	¹ <u>Contact Name</u>	<u>Type of</u>	<u>Contract</u>	✓ i f <u>DBE</u>
<u>ADDRESS</u>	² AK Business <u>License No.</u>	² <u>Phone No.</u>	<u>Work</u>	<u>Amount</u>	
1. _____ _____ _____	1 _____ 2 _____	_____ _____	_____ _____	\$ _____	<input type="checkbox"/>
2. _____ _____ _____	1 _____ 2 _____	_____ _____	_____ _____	\$ _____	<input type="checkbox"/>
3. _____ _____ _____	1 _____ 2 _____	_____ _____	_____ _____	\$ _____	<input type="checkbox"/>
4. _____ _____ _____	1 _____ 2 _____	_____ _____	_____ _____	\$ _____	<input type="checkbox"/>

I certify that the above listed Alaska Business License(s) and CONTRACTOR Registration(s), if applicable, were valid at the time Bids were opened for this Project.

CONTRACTOR, Authorized Signature

CONTRACTOR, Printed Name

COMPANY

SECTION 00360 - SUBCONTRACTOR REPORT

- A. Bidder may replace a listed Subcontractor if the Subcontractor:
1. fails to comply with AS 08.18;
 2. files for bankruptcy or becomes insolvent;
 3. fails to execute a contract with the Bidder involving performance of the WORK for which the Subcontractor was listed and the Bidder acted in good faith;
 4. fails to obtain bonding;
 5. fails to obtain insurance acceptable to the OWNER;
 6. fails to perform the contract with the Bidder involving work for which the Subcontractor was listed;
 7. must be substituted in order for the CONTRACTOR to satisfy required state and federal affirmative action requirements;
 8. refuses to agree or abide with the Bidder's labor agreement; or
 9. is determined by the OWNER not to be responsible.
 10. is not in "Good Standing" with the OWNER as required in Article 21.0 in Section 00100 – Instructions to Bidders.
- B. If a Bidder fails to list a Subcontractor or lists more than one Subcontractor for the same portion of WORK, the Bidder shall be considered to have agreed to perform that portion of WORK without the use of a Subcontractor and to have represented the Bidder to be qualified to perform that WORK.
- C. A Bidder who attempts to circumvent the requirements of this section by listing as a Subcontractor another contractor who, in turn, sublets the majority of the WORK required under the contract violates this section.
- D. If a contract is awarded to a Bidder who violates this section, the OWNER may:
1. cancel the contract; or
 2. after notice and a hearing, assess a penalty on the Bidder in an amount that does not exceed 10 percent of the value of the subcontract at issue.
- E. On the Subcontractor Report, the apparent low Bidder must list any Subcontractors anticipated to perform WORK with a value of greater than one-half of one percent of the intended award amount, or \$2,000, whichever is less.
- F. An apparent low Bidder who fails to submit a completed Subcontractor Report within the time specified in this section may be found to be not a responsible Bidder and may be required to forfeit the Bid security. The OWNER will then consider the next lowest Bidder for award of the contract.

END OF SECTION

SECTION 00370 - CONTRACTOR'S FINANCIAL RESPONSIBILITY

To be considered, all bidders must complete and include this form *at the time of the deadline for bids*. Attach additional sheets as necessary to respond to questions.

PROJECT: Bartlett Regional Hospital MRI & CT Replacement, Contract No. BE23-042

As the General Contractor on this project, I intend to subcontract _____% of the total value of this contract.

A. EXPERIENCE

1. Have you ever failed to complete a contract due to insufficient resources?

No Yes If YES, explain:

2. Describe arrangements you have made to finance this work:

3. Have you had previous construction contracts or subcontracts with the City and Borough of Juneau?

Yes No

4. Describe your most recent or current contract, its completion date, and scope of work:

5. List below, and/or as an attachment to this questionnaire, other construction projects you have completed, dates of completion, scope of work, and total contract amount for each project completed in the past twelve months.

SECTION 00370 - CONTRACTOR'S FINANCIAL RESPONSIBILITY

6. Per Alaska Statute 36.90.210, on previously awarded public contracts (including contracts still in progress), have you ever failed to pay a subcontractor **or** material supplier **within eight working days** after receiving payment from the Owner (for projects occurring within the last 3 years)?

Yes No If yes, please attach a detailed explanation for **each** occurrence.

B. EQUIPMENT

1. Describe below, and/or as an attachment, the equipment you have available and intend to use for this project.

ITEM	QUANTITY	MAKE	MODEL	SIZE/CAPACITY	PRESENT MARKET VALUE

2. Do you propose to purchase any equipment for use on this project not listed on table B-1?

No Yes If YES, describe type, quantity, and approximate cost:

3. Do you propose to rent any equipment for this work not listed on table B-1?

No Yes If YES, describe type and quantity:

SECTION 00370 - CONTRACTOR'S FINANCIAL RESPONSIBILITY

4. Is your bid based on firm offers for all materials necessary for this project?

Yes No If NO, please explain:

I hereby certify that the above statements are true and complete.

Signature

Company Name

Printed Name

Date

SECTION 00500 - AGREEMENT

THIS AGREEMENT is between THE CITY AND BOROUGH OF JUNEAU (hereinafter called OWNER) and _____ (hereinafter called CONTRACTOR) OWNER and CONTRACTOR, in consideration of the mutual covenants hereinafter set forth, agree as follows:

ARTICLE 1. WORK.

CONTRACTOR shall complete the WORK as specified or as indicated under the Bid Schedule of the OWNERS Contract Documents **Contract BE23-042, Bartlett Regional Hospital MRI & CT Replacement.**

The WORK is generally described as the work required to facilitate the replacement of three (3) medical imaging modalities including two (2) CT scanners and one (1) MRI. This works includes the addition of new chiller to cool the equipment, equipment screen, replacement of interior finishes as necessary, and the necessary infrastructure to support a temporary MRI trailer during construction operations.

There are no modifications proposed to egress, construction classification, use, occupancy, building area, or rated assemblies.

The contractor, as a delegated design, shall address the fire alarm system, automatic sprinkler system, RF shielding, and Magnetic Shielding. The Work shall be phased; See Sheet D101 and A101 in The Drawings.

The WORK to be paid under this contract shall include the following: Base Bid and Additive Alternate No. 1 as shown in Section 00310 - Bid Schedule.

ARTICLE 2. CONTRACT COMPLETION TIME.

<u>Work Description</u>	<u>Completion Date</u>
Substantial Completion – Phase I*	July 18, 2023
Final Completion – Phase I	30 days after substantial completion
Substantial Completion – Phase II	December 8, 2023
Final Completion – Phase II	30 days after substantial completion

*Subject to change due to supply chain issues with critical equipment.

ARTICLE 3. DATE OF AGREEMENT

The date of this agreement will be the date of the last signature on page three of this section.

ARTICLE 4. LIQUIDATED DAMAGES.

OWNER and the CONTRACTOR recognize that time is of the essence of this Agreement and that the OWNER will suffer financial loss if the WORK is not completed within the time specified in Article 2 herein, plus any extensions thereof allowed in accordance with Article 12 of the General Conditions. They also recognize the delays, expense, and difficulties involved in proving in a legal proceeding the actual damages suffered by the OWNER if the WORK is not completed on time. Accordingly, instead of requiring any such proof, the OWNER and the CONTRACTOR agree that as liquidated damages for delay (but not as a penalty) the CONTRACTOR shall pay the OWNER **\$1,000** for each Day that expires after the completion time(s) specified in Article 2 herein. The amount of liquidated damages specified above is agreed to be a reasonable estimate based on all facts known as of the date of this Agreement.

SECTION 00500 - AGREEMENT

ARTICLE 5. CONTRACT PRICE.

OWNER shall pay CONTRACTOR for completion of the WORK in accordance with the Contract Documents in current funds the amount set forth in the Bid Schedule. The CONTRACTOR agrees to accept as full and complete payment for all WORK to be done in this contract for: **CBJ Contract BE23-042, Bartlett Regional Hospital MRI & CT Replacement**, those Lump Sum amounts as set forth in the Bid Schedule in the Contract Documents for this Project.

The total amount of this contract shall be _____ (\$ _____), except as adjusted in accordance with the provisions of the Contract Documents.

ARTICLE 6. PAYMENT PROCEDURES.

CONTRACTOR shall submit Applications for Payment in accordance with Article 14 of the General Conditions. Applications for Payment will be processed by the ARCHITECT as provided in the General Conditions.

Progress payments will be paid in full in accordance with Article 14 of the General Conditions until ninety (90) percent of the Contract Price has been paid. The remaining ten (10) percent of the Contract Price may be retained, in accordance with applicable Alaska State Statutes, until final inspection, completion, and acceptance of the Project by the OWNER.

ARTICLE 7. CONTRACT DOCUMENTS.

The Contract Documents which comprise the entire Agreement between OWNER and CONTRACTOR concerning the WORK consist of this Agreement (pages 00500-1 to 00500-6, inclusive) and the following sections of the Contract Documents:

- Table of Contents (pages 00005-1 to 00005-4, inclusive).
- Project Labor Agreement (pages 00010-1 to 00010-16, inclusive).
- Notice Inviting Bids (pages 00030-1 to 00030-2, inclusive).
- Instructions to Bidders (pages 00100-1 to 00100-10, inclusive).
- Bid (pages 00300-1 to 00300-3, inclusive).
- Bid Schedule (pages 00310-1, inclusive).
- Bid Bond (page 00320-1, inclusive) or Bid Security.
- Subcontractor Report (pages 00360-1 to 00360-2, inclusive).
- Contractor Financial Responsibility (pages 00370-1 to 00370-3, inclusive).
- Performance Bond (pages 00610-1 to 00610-2, inclusive).
- Payment Bond (pages 00620-1 to 00620-2, inclusive).
- Insurance Certificate(s).
- General Conditions (pages 00700-1 to 00700-44, inclusive).
- Supplementary General Conditions (pages 00800-1 to 00800-7, inclusive).
- Alaska Labor Standards, Reporting, and Prevailing Wage Determination (pages 00830-1 to 00830-41, inclusive).
- Technical Specifications, including Appendix A, as listed in the Table of Contents.
- Drawings consisting of 44 sheets, as listed in the Table of Contents.

There are no Contract Documents other than those listed in this Article 7. The Contract Documents may only be amended by Change Order as provided in Paragraph 3.3 of the General Conditions.

SECTION 00500 - AGREEMENT

ARTICLE 8. MISCELLANEOUS.

Terms used in this Agreement which are defined in Article 1 of the General Conditions will have the meanings indicated in the General Conditions.

No assignment by a party hereto of any rights under or interests in the Contract Documents will be binding on another party hereto without the written consent of the party sought to be bound; and specifically but without limitation monies that may become due and monies that are due may not be assigned without such consent (except to the extent that the effect of this restriction may be limited by law), and unless specifically stated to the contrary in any written consent to an assignment, no assignment will release or discharge the assignor from any duty or responsibility under the Contract Documents.

OWNER and CONTRACTOR each binds itself, its partners, successors, assigns and legal representatives to the other party hereto, its partners, successors, assigns and legal representatives in respect of all covenants, agreements and obligations contained in the Contract Documents. This Agreement shall be governed by the laws of the State of Alaska. Jurisdiction shall be in the State of Alaska, First Judicial District.

IN WITNESS WHEREOF, OWNER and CONTRACTOR have caused this Agreement to be executed on the date listed below signed by OWNER.

OWNER:

CONTRACTOR:

_____ City and Borough of Juneau

_____ (Company Name)

_____ (Signature)

_____ (Signature)

By: Duncan Rorie Watt, City & Borough Manager
(Printed Name)

By: _____
(Printed Name, Authority or Title)

Date: _____

Date: _____
(CONTRACTOR Signature Date)

OWNER's address for giving notices:

CONTRACTOR's address for giving notices:

_____ 155 South Seward Street

_____ Juneau, Alaska 99801

_____ 907-586-0800 907-586-4530
(Telephone) (Fax)

_____ (Telephone) (Fax)

_____ (E-mail address)

CONTRACTOR License No. _____

SECTION 00500 - AGREEMENT

CERTIFICATE
(if Corporation)

STATE OF)
) SS:
COUNTY OF)

I HEREBY CERTIFY that a meeting of the Board of Directors of the _____ a corporation existing under the laws of the State of _____, held on _____, 20 ____, the following resolution was duly passed and adopted:

“RESOLVED, that _____, as _____ President of the Corporation, be and is hereby authorized to **execute the Agreement** with the CITY AND BOROUGH OF JUNEAU and this corporation and that the execution thereof, attested by the Secretary of the Corporation, and with the Corporate Seal affixed, shall be the official act and deed of this Corporation.”

I further certify that said resolution is now in full force and effect.

IN WITNESS WHEREOF, I have hereunto set my hand and affixed the official seal of the corporation this _____ day of _____, 20 ____.

Secretary

(SEAL)

SECTION 00500 - AGREEMENT

CERTIFICATE
(if Partnership)

STATE OF)
) SS:
COUNTY OF)

I HEREBY CERTIFY that a meeting of the Partners of the _____ a partnership existing under the laws of the State of _____, held on _____, 20____, the following resolution was duly passed and adopted:

"RESOLVED, that _____, as _____ of the Partnership, be and is hereby authorized to **execute the Agreement** with the CITY AND BOROUGH OF JUNEAU and this partnership and that the execution thereof, attested by the _____ shall be the official act and deed of this Partnership."

I further certify that said resolution is now in full force and effect.

IN WITNESS WHEREOF, I have hereunto set my hand this _____, day of _____, 20_____.

Secretary

(SEAL)

SECTION 00500 - AGREEMENT

CERTIFICATE
(if Joint Venture)

STATE OF)
) SS:
COUNTY OF)

I HEREBY CERTIFY that a meeting of the Principals of the

_____ a joint venture existing under the laws of the

State of _____, held on _____, 20____, the following resolution was duly passed and adopted:

"RESOLVED, that _____, as _____ of the Joint Venture, be and is hereby authorized to **execute the Agreement** with the CITY AND BOROUGH OF JUNEAU and this joint venture and that the execution thereof, attested by the _____ shall be the official act and deed of this Joint Venture."

I further certify that said resolution is now in full force and effect.

IN WITNESS WHEREOF, I have hereunto set my hand this _____, day of _____, 20____.

Secretary

(SEAL)

END OF SECTION

SECTION 00610 - PERFORMANCE BOND

KNOW ALL PERSONS BY THESE PRESENTS: That we _____
(Name of CONTRACTOR)

a _____
(Corporation, Partnership, Individual)

hereinafter called "Principal" and _____
(Surety)

of _____, State of _____ hereinafter called the "Surety", are held and firmly bound to the CITY AND BOROUGH of JUNEAU, ALASKA hereinafter called "OWNER", for the penal sum
(Owner) (City and State)

of _____ dollars (\$ _____) in lawful money of the United States, for the payment of which sum well and truly to be made, we bind ourselves, our heirs, executors, administrators and successors, jointly and severally, firmly by these presents.

THE CONDITION OF THIS OBLIGATION is such that whereas, the CONTRACTOR has entered into a certain contract with the OWNER, the effective date of which is (CBJ Contracts Office to fill in effective date) _____, a copy of which is hereto attached and made a part hereof for the construction of:

**Bartlett Regional Hospital MRI & CT Replacement
CBJ Contract No. BE23-042**

NOW, THEREFORE, if the Principal shall truly and faithfully perform its duties, all the undertakings, covenants, terms, conditions, and agreements of said contract during the original term thereof, and any extensions thereof, which may be granted by the OWNER, with or without notice to the Surety, and if it shall satisfy all claims and demands incurred under such contract, and shall fully indemnify and save harmless the OWNER from all costs and damages which it may suffer by reason of failure to do so, and shall reimburse and repay the OWNER all outlay and expense which the OWNER may incur in making good any default, then this obligation shall be void; otherwise to remain in full force and effect.

PROVIDED, FURTHER, that the said Surety, for value received hereby stipulates and agrees that no change, extension of time, alteration or addition to the terms of the contract or to the WORK to be performed thereunder or the specifications accompanying the same shall in any wise affect its obligation on this bond, and it does hereby waive notice of any such change, extension of time, alteration or addition to the terms of the contract or to the WORK or to the Specifications.

PROVIDED, FURTHER, that no final settlement between the OWNER and the Principal shall abridge the right of any beneficiary hereunder, whose claim may be unsatisfied.

SECTION 00610 - PERFORMANCE BOND

**Bartlett Regional Hospital MRI & CT Replacement
CBJ Contract No. BE23-042**

IN WITNESS WHEREOF, this instrument is issued in two (2) identical counterparts, each one of which shall be deemed an original.

CONTRACTOR:

By: _____
(Signature)

(Printed Name)

(Company Name)

(Mailing Address)

(City, State, Zip Code)

SURETY:

By: _____
(Signature of Attorney-in-Fact)

Date Issued: _____

(Printed Name)

(Company Name)

(Mailing Address)

(City, State, Zip Code)

(Affix SURETY'S SEAL)

NOTE: If CONTRACTOR is Partnership, all Partners must execute bond.

SECTION 00620 - PAYMENT BOND

KNOW ALL PERSONS BY THESE PRESENTS: That we _____
(Name of CONTRACTOR)

_____ a _____
(Corporation, Partnership, Individual)

hereinafter called "Principal" and _____
(Surety)

of _____, State of _____ hereinafter called the "Surety," are held and
firmly bound to the CITY AND BOROUGH of JUNEAU, ALASKA hereinafter called "OWNER," for the
(Owner) (City and State)

penal sum of _____ Dollars
(\$ _____) in lawful money of the United States, for the payment of which sum well
and truly to be made, we bind ourselves, our heirs, executors, administrators and successors, jointly and
severally, firmly by these presents.

THE CONDITION OF THIS OBLIGATION is such that Whereas, the CONTRACTOR has entered
into a certain contract with the OWNER, the effective date of which is (CBJ Contracts Office to fill in effective
date) _____, a copy of which is hereto attached and made a part hereof for the
construction of:

**Bartlett Regional Hospital MRI & CT Replacement
CBJ Contract No. BE23-042**

NOW, THEREFORE, if the Principal shall promptly make payment to all persons, firms,
Subcontractors, and corporations furnishing materials for, or performing labor in the prosecution of the WORK
provided for in such contract, and any authorized extension or modification thereof, including all amounts due
for materials, lubricants, oil, gasoline, coal and coke, repairs on machinery, equipment and tools, consumed or
used in connection with the construction of such WORK, and all insurance premiums on said work, and for all
labor performed in such WORK, whether by Subcontractor or otherwise, then this obligation shall be void;
otherwise to remain in full force and effect.

PROVIDED, FURTHER, that the said Surety, for value received hereby stipulates and agrees that no
change, extension of time, alteration or addition to the terms of the contract or to the WORK to be performed
thereunder or the specifications accompanying the same shall in any wise affect its obligation on this bond, and
it does hereby waive notice of any such change, extension of time, alteration or addition to the terms of the
contract or to the WORK or to the Specifications.

PROVIDED, FURTHER, that no final settlement between the OWNER and the Principal shall abridge
the right of any beneficiary hereunder, whose claim may be unsatisfied.

SECTION 00620 - PAYMENT BOND

**Bartlett Regional Hospital MRI & CT Replacement
CBJ Contract No. BE23-042**

IN WITNESS WHEREOF, this instrument is issued in two (2) identical counterparts, each one of which shall be deemed an original.

CONTRACTOR:

By: _____
(Signature)

(Printed Name)

(Company Name)

(Mailing Address)

(City, State, Zip Code)

SURETY:

By: _____
(Signature of Attorney-in-Fact)

Date Issued: _____

(Printed Name)

(Company Name)

(Mailing Address)

(City, State, Zip Code)

(Affix SURETY'S SEAL)

NOTE: If CONTRACTOR is Partnership, all Partners must execute bond.

SECTION 00700 - GENERAL CONDITIONS

TABLE OF CONTENTS

ARTICLE 1 DEFINITIONS 00700-5

ARTICLE 2 PRELIMINARY MATTERS

2.1 Delivery of Bonds/Insurance Certificates 00700-9
2.2 Copies of Documents 00700-9
2.3 Commencement of Contract Time; Notice to Proceed 00700-9
2.4 Starting the WORK 00700-9
2.5 Pre-construction Conference 00700-9
2.6 Finalizing CONTRACTOR Submittals..... 00700-9

ARTICLE 3 CONTRACT DOCUMENTS: INTENT, AMENDING, REUSE

3.1 Intent 00700-10
3.2 Order of Precedence of Contract Documents 00700-10
3.3 Amending and Supplementing Contract Documents..... 00700-11
3.4 Reuse of Documents..... 00700-11

ARTICLE 4 AVAILABILITY OF LANDS; PHYSICAL CONDITIONS; REFERENCE POINTS

4.1 Availability of Lands 00700-11
4.2 Physical Conditions - Subsurface and Existing Structures 00700-11
4.3 Differing Site Conditions 00700-12
4.4 Physical Conditions - Underground Utilities 00700-12
4.5 Reference Points 00700-13
4.6 Use of the CBJ/State Lemon Creek Gravel Pit 00700-13

ARTICLE 5 BONDS AND INSURANCE

5.1 Performance, Payment and Other Bonds 00700-14
5.2 Insurance 00700-15

ARTICLE 6 CONTRACTOR'S RESPONSIBILITIES

6.1 Supervision and Superintendence..... 00700-16
6.2 Labor, Materials, and Equipment 00700-17
6.3 Adjusting Progress Schedule 00700-18
6.4 Substitutes or "Or Equal" Items..... 00700-18
6.5 Concerning Subcontractors, Suppliers and Others 00700-18
6.6 Permits..... 00700-18
6.7 Patent Fees and Royalties 00700-19
6.8 Laws and Regulations..... 00700-19

SECTION 00700 - GENERAL CONDITIONS

TABLE OF CONTENTS

ARTICLE 6 CONTRACTOR'S RESPONSIBILITIES (Cont'd.)

6.9 Taxes 00700-19
6.10 Use of Premises 00700-19
6.11 Safety and Protection 00700-20
6.12 Shop Drawings and Samples 00700-21
6.13 Continuing the WORK 00700-21
6.14 Indemnification 00700-21
6.15 CONTRACTOR's Daily Reports 00700-22
6.16 Assignment of Contract 00700-22
6.17 CONTRACTOR's Responsibility for Utility Property and Services 00700-22
6.18 Operating Water System Valves 00700-22
6.19 Contractor's Work Schedule Limitations 00700-23

ARTICLE 7 OTHER WORK

7.1 Related Work at Site 00700-23
7.2 Coordination 00700-23

ARTICLE 8 OWNER'S RESPONSIBILITIES

8.1 Communications 00700-24
8.2 Payments 00700-24
8.3 Lands, Easements, and Surveys 00700-24
8.4 Change Orders 00700-24
8.5 Inspections and Tests 00700-24
8.6 Suspension of WORK 00700-24
8.7 Termination of Agreement 00700-24

ARTICLE 9 ARCHITECT'S STATUS DURING CONSTRUCTION

9.1 OWNER's Representative 00700-24
9.2 Visits to Site 00700-24
9.3 Project Representation 00700-24
9.4 Clarifications and Interpretations 00700-24
9.5 Authorized Variations in WORK 00700-25
9.6 Rejecting or Accepting Defective WORK 00700-25
9.7 CONTRACTOR Submittals, Change Orders, and Payments 00700-25
9.8 Decisions on Disputes 00700-25
9.9 Limitation on ARCHITECT's Responsibilities 00700-26

SECTION 00700 - GENERAL CONDITIONS

TABLE OF CONTENTS

ARTICLE 10 CHANGES IN THE WORK

10.1 General 00700-26
10.2 Allowable Quantity Variations 00700-27

ARTICLE 11 CHANGE OF CONTRACT PRICE

11.1 General 00700-27
11.2 Costs Relating to Weather 00700-28
11.3 Cost of WORK (Based on Time and Materials) 00700-28
11.4 CONTRACTOR's Fee 00700-31
11.5 Excluded Costs 00700-31

ARTICLE 12 CHANGE OF CONTRACT TIME

12.1 General 00700-32
12.2 Extensions of Time for Delay Due to Weather 00700-33

**ARTICLE 13 WARRANTY AND GUARANTEE; TESTS AND INSPECTIONS;
CORRECTION, REMOVAL, OR ACCEPTANCE OF DEFECTIVE WORK**

13.1 Warranty and Guarantee 00700-33
13.2 Access to WORK 00700-33
13.3 Inspections and Tests 00700-33
13.4 OWNER May Stop the WORK 00700-34
13.5 Correction or Removal of Defective WORK 00700-34
13.6 One Year Correction Period 00700-34
13.7 Acceptance of Defective WORK 00700-35

ARTICLE 14 PAYMENTS TO CONTRACTOR AND COMPLETION

14.1 Schedule of Values (Lump Sum Price Breakdown) 00700-35
14.2 Unit Price Bid Schedule 00700-35
14.3 Application for Progress Payment 00700-35
14.4 CONTRACTOR's Warranty of Title 00700-36
14.5 Review of Applications for Progress Payment 00700-36
14.6 Partial Utilization 00700-37
14.7 Substantial Completion 00700-37
14.8 Final Application for Payment 00700-37
14.9 Final Payment and Acceptance 00700-37
14.10 Release of Retainage and Other Deductions 00700-38
14.11 CONTRACTOR's Continuing Obligation 00700-38
14.12 Final Payment Terminates Liability of OWNER 00700-38

SECTION 00700 - GENERAL CONDITIONS

TABLE OF CONTENTS

ARTICLE 15 SUSPENSION OF WORK AND TERMINATION

15.1 Suspension of WORK by OWNER..... 00700-39
15.2 Termination of Agreement by OWNER (CONTRACTOR Default)..... 00700-39
15.3 Termination of Agreement by OWNER (For Convenience) 00700-39
15.4 Termination of Agreement by CONTRACTOR..... 00700-39

ARTICLE 16 MISCELLANEOUS

16.1 Giving Notice 00700-40
16.2 Rights In and Use of Materials Found on the WORK 00700-40
16.3 Right to Audit..... 00700-41
16.4 Archaeological or Historical Discoveries 00700-41
16.5 Construction Over or Adjacent to Navigable Waters 00700-41
16.6 Gratuity and Conflict of Interest..... 00700-41
16.7 Suits of Law Concerning the WORK 00700-41
16.8 Certified Payrolls..... 00700-42
16.9 Prevailing Wage Rates 00700-42
16.10 Employment Reference 00700-42
16.11 Cost Reduction Incentive 00700-43

SECTION 00700 - GENERAL CONDITIONS

ARTICLE 1 DEFINITIONS

Wherever used in these General Conditions or in the Contract Documents the following terms have the meanings indicated which are applicable to both the singular and plural thereof. Where a word is capitalized in the definitions and is found not capitalized in the Contract Documents it has the ordinary dictionary definition.

Addenda - Written or graphic instruments issued prior to the opening of Bids which make additions, deletions, or revisions to the Contract Documents.

Agreement - The written contract between the OWNER and the CONTRACTOR covering the WORK to be performed; other documents are attached to the Agreement and made a part thereof as provided therein.

Application for Payment - The form furnished by the ARCHITECT which is to be used by the CONTRACTOR to request progress or final payment and which is to be accompanied by such supporting documentation as is required by the Contract Documents.

ARCHITECT - The ARCHITECT is the firm or person(s) selected by the City and Borough of Juneau (CBJ) to perform the duties of project inspection and management. CBJ will inform the CONTRACTOR of the identity of the ARCHITECT at or before the Notice to Proceed.

Architect of Record – The individual, partnership, corporation, joint-venture or other legal entity legally responsible for preparation of Design and Construction Documents for the project.

Asbestos - Any material that contains more than one percent asbestos and is friable or is releasing asbestos fibers into the air above current action levels established by the United States Occupational Safety and Health Administration.

Bid - The offer or proposal of the Bidder submitted on the prescribed form setting forth the price or prices for the WORK.

Bonds - Bid, Performance, and Payment Bonds and other instruments which protect against loss due to inability or refusal of the CONTRACTOR to perform its contract.

CBJ - City and Borough of Juneau

CBJ Project Manager - The authorized representative of the City and Borough of Juneau Engineering Department, as OWNER, who is responsible for administration of the contract.

Change Order - A document recommended by the ARCHITECT, which is signed by the CONTRACTOR and the OWNER and authorizes an addition, deletion, or revision in the WORK, or an adjustment in the Contract Price or the Contract Time, issued on or after the Effective Date of the Agreement.

Contract Documents - The Table of Contents, Notice Inviting Bids, Instructions to Bidders, Bid Forms (including the Bid, Bid Schedule(s), Information Required of Bidder, Bid Bond, and all required certificates and affidavits), Agreement, Performance Bond, Payment Bond, General Conditions, Supplementary General Conditions, Technical Specifications, Drawings, Permits, and all Addenda, Field Orders and Change Orders executed pursuant to the provisions of the Contract Documents.

SECTION 00700 - GENERAL CONDITIONS

Contract Price - The total monies payable by the OWNER to the CONTRACTOR under the terms and conditions of the Contract Documents.

Contract Time - The number of successive calendar Days or the specific date stated in the Contract Documents for the completion of the WORK.

CONTRACTOR - The individual, partnership, corporation, joint-venture or other legal entity with whom the OWNER has executed the Agreement.

Day - A calendar day of 24 hours measured from midnight to the next midnight.

Defective WORK - WORK that is unsatisfactory, faulty, or deficient; or that does not conform to the Contract Documents; or that does not meet the requirements of any inspection, reference standard, test, or approval referred to in the Contract Documents; or WORK that has been damaged prior to the ARCHITECT's recommendation of final payment.

Drawings - The drawings, plans, maps, profiles, diagrams, and other graphic representations which indicate the character, location, nature, extent, and scope of the WORK and which have been prepared by the Architect of Record and are referred to in the Contract Documents. Shop Drawings are not within the meaning of this paragraph.

Effective Date of the Agreement - The date indicated in the Agreement on which it becomes effective, but if no such date is indicated it means the date on which the Agreement is signed and delivered by the last of the two parties to sign and deliver.

Field Order - A written order issued by the ARCHITECT which may or may not involve a change in the WORK.

General Requirements - Division 1 of the Technical Specifications.

Hazardous Waste - The term Hazardous Waste shall have the meaning provided in Section 1004 of the Solid Waste Disposal Act (42 USC Section 9603) as amended from time to time.

Holidays - The CBJ legal holidays occur on:

- A. New Year's Day - January 1
- B. Martin Luther King's Birthday - Third Monday in January
- C. President's Day - Third Monday in February
- D. Seward's Day - Last Monday in March
- E. Memorial Day - Last Monday in May
- F. Independence Day - July 4
- G. Labor Day - First Monday in September
- H. Alaska Day - October 18
- I. Veteran's Day - November 11
- J. Thanksgiving Day - Fourth Thursday and the following Friday in November
- K. Christmas Day - December 25.

SECTION 00700 - GENERAL CONDITIONS

If any holiday listed above falls on a Saturday, Saturday and the preceding Friday are both legal holidays. If the holiday should fall on a Sunday, Sunday and the following Monday are both legal holidays.

Inspector - The authorized representative of the ARCHITECT assigned to make detailed inspections for conformance to the Contract Documents. Any reference to the Resident Project Representative in this document shall mean the Inspector.

Laws and Regulations; Laws or Regulations - Any and all applicable laws, rules, regulations, ordinances, codes, and/or orders of any and all governmental bodies, agencies, authorities and courts having jurisdiction.

Mechanic's Lien - A form of security, an interest in real property, which is held to secure the payment of an obligation. When referred to in these Contract Documents, "Mechanic's Lien" or "lien" means "Stop Notice".

Milestone - A principal event specified in the Contract Documents relating to an intermediate completion date of a portion of the work, or a period of time within which the portion of the work should be performed prior to Substantial Completion of all the WORK.

Notice of Intent to Award - The written notice by the OWNER to the apparent successful bidder stating that upon compliance by the apparent successful bidder with the requirements listed therein, within the time specified, the OWNER will enter into an Agreement.

Notice of Award - The written notice by the OWNER to the apparent successful bidder stating that the apparent successful bidder has complied with all conditions for award of the contract.

Notice of Completion - A form signed by the ARCHITECT and the CONTRACTOR recommending to the OWNER that the WORK is Substantially Complete and fixing the date of Substantial Completion. After acceptance of the WORK by the OWNER's governing body, the form is signed by the OWNER. This filing starts the 30 day lien filing period on the WORK.

Notice to Proceed - The written notice issued by the OWNER to the CONTRACTOR authorizing the CONTRACTOR to proceed with the WORK and establishing the date of commencement of the Contract Time.

OWNER - The City and Borough of Juneau (CBJ), acting through its legally designated officials, officers, or employees.

Partial Utilization - Use by the OWNER of a substantially completed part of the WORK for the purpose for which it is intended prior to Substantial Completion of all the WORK.

PCB's - Polychlorinated biphenyls.

Petroleum - Petroleum, including crude oil or any fraction thereof which is liquid at standard conditions of temperature and pressure (60 degrees Fahrenheit and 14.7 pounds per square inch absolute), such as oil, petroleum, fuel oil, oil sludge, oil refuse, gasoline, kerosene, and oil mixed with other non-Hazardous Wastes and crude oils.

Project - The total construction of which the WORK to be provided under the Contract Documents may be the whole, or a part as indicated elsewhere in the Contract Documents.

SECTION 00700 - GENERAL CONDITIONS

Radioactive Material - Source, special nuclear, or byproduct material as defined by the Atomic Energy Act of 1954 (42 USC Section 2011 et seq.) as amended from time to time.

Shop Drawings - All drawings, diagrams, illustrations, schedules and other data which are specifically prepared by or for the CONTRACTOR and submitted by the CONTRACTOR, to the ARCHITECT, to illustrate some portion of the WORK.

Specifications - Same definition as for "Technical Specifications" hereinafter.

Stop Notice - A legal remedy for subcontractors and suppliers who contribute to public works, but who are not paid for their work, which secures payment from construction funds possessed by the OWNER. For public property, the Stop Notice remedy is designed to substitute for mechanic's lien rights.

Sub-Consultant - The individual, partnership, corporation, joint-venture or other legal entity having a direct contract with Architect of Record, or with any of its Consultants to furnish services with respect to the Project.

Subcontractor - An individual, partnership, corporation, joint-venture or other legal entity having a direct contract with the CONTRACTOR, or with any of its Subcontractors, for the performance of a part of the WORK at the site.

Substantial Completion - Refers to when the WORK has progressed to the point where, in the opinion of the ARCHITECT as evidenced by Notice of Completion as applicable, it is sufficiently complete, in accordance with the Contract Documents, so that the WORK can be utilized for the purposes for which it is intended; or if no such notice is issued, when final payment is due in accordance with Paragraph 14.8. The terms "substantially complete" and "substantially completed" as applied to any WORK refer to Substantial Completion thereof.

Supplementary General Conditions - The part of the Contract Documents which make additions, deletions, or revisions to these General Conditions.

Supplier - A manufacturer, fabricator, supplier, distributor, material man, or vendor.

Technical Specifications - Divisions 1 through 16 of the Contract Documents consisting of the General Requirements and written technical descriptions of products and execution of the WORK.

Underground Utilities - All pipelines, conduits, ducts, cables, wires, manholes, vaults, tanks, tunnels, or other such facilities or attachments, and any encasements containing such facilities which have been installed underground to furnish any of the following services or materials: water, sewage and drainage removal, electricity, gases, steam, liquid petroleum products, telephone or other communications, cable television, traffic, or other control systems.

WORK, Work - The entire completed construction or the various separately identifiable parts thereof required to be furnished under the Contract Documents. WORK is the result of performing, or furnishing labor and furnishing and incorporating materials and equipment into the construction, and performing or furnishing services and furnishing documents, all as required by the Contract Documents.

SECTION 00700 - GENERAL CONDITIONS

ARTICLE 2 PRELIMINARY MATTERS

- 2.1 DELIVERY OF BONDS/INSURANCE CERTIFICATES. When the CONTRACTOR delivers the signed Agreements to the OWNER, the CONTRACTOR shall also deliver to the OWNER such Bonds and Insurance Policies and Certificates as the CONTRACTOR may be required to furnish in accordance with the Contract Documents.
- 2.2 COPIES OF DOCUMENTS. The OWNER shall furnish to the CONTRACTOR the required number of copies of the Contract Documents specified in the Supplementary General Conditions.
- 2.3 COMMENCEMENT OF CONTRACT TIME; NOTICE TO PROCEED. The Contract Time will start to run on the commencement date stated in the Notice to Proceed. If no date is stated, Contract Time shall commence upon the date of the Notice to Proceed is issued.
- 2.4 STARTING THE WORK
- A. The CONTRACTOR shall begin to perform the WORK within 10 days after the commencement date stated in the Notice to Proceed, but no WORK shall be done at the site prior to said commencement date.
 - B. Before undertaking each part of the WORK, the CONTRACTOR shall carefully study and compare the Contract Documents and check and verify pertinent figures shown thereon and all applicable field measurements. The CONTRACTOR shall promptly report in writing to the ARCHITECT any conflict, error, or discrepancy which the CONTRACTOR may discover and shall obtain a written interpretation or clarification from the ARCHITECT before proceeding with any WORK affected thereby.
 - C. The CONTRACTOR shall submit to the ARCHITECT for review those documents called for under Section 01300 - CONTRACTOR Submittals in the General Requirements.
- 2.5 PRE-CONSTRUCTION CONFERENCE. The CONTRACTOR is required to attend a Pre-Construction Conference. This conference will be attended by the ARCHITECT and others as appropriate in order to discuss the WORK in accordance with the applicable procedures specified in the General Requirements, Section 01010 - Summary of Work.
- 2.6 FINALIZING CONTRACTOR SUBMITTALS. At least 7 days before submittal of the first Application for Payment a conference attended by the CONTRACTOR, the ARCHITECT and others as appropriate will be held to finalize the initial CONTRACTOR submittals in accordance with the General Requirements. As a minimum the CONTRACTOR's representatives should include it's project manager and schedule expert. The CONTRACTOR should plan on this meeting taking no less than 8 hours. If the submittals are not finalized at the end of the meeting, additional meetings will be held so that the submittals can be finalized prior to the submittal of the first Application for Payment. No Application for Payment will be processed until CONTRACTOR submittals are finalized.

SECTION 00700 - GENERAL CONDITIONS

ARTICLE 3 CONTRACT DOCUMENTS: INTENT, AMENDING, REUSE

3.1 INTENT

- A. The Contract Documents comprise the entire agreement between the OWNER and the CONTRACTOR concerning the WORK. The Contract Documents shall be construed as a whole in accordance with Alaska Law.
- B. It is the intent of the Contract Documents to describe the WORK, functionally complete, to be constructed in accordance with the Contract Documents. Any WORK, materials, or equipment that may reasonably be inferred from the Contract Documents as being required to produce the intended result shall be supplied whether or not specifically called for. When words or phrases which have a well-known technical or construction industry or trade meaning are used to describe WORK, materials, or equipment such words or phrases shall be interpreted in accordance with that meaning, unless a definition has been provided in Article 1 of the General Conditions. Reference to standard specifications, manuals, or codes of any technical society, organization, or association, or to the Laws or Regulations of any governmental authority, whether such reference be specific or by implication, shall mean the latest standard specification, manual, code, or Laws or Regulations in effect at the time of opening of Bids, except as may be otherwise specifically stated. However, no provision of any referenced standard specification, manual, or code (whether or not specifically incorporated by reference in the Contract Documents) shall be effective to change the duties and responsibilities of the ARCHITECT, OWNER, the CONTRACTOR, or the Architect of Record or any of their consultants, agents, or employees from those set forth in the Contract Documents.
- C. If, during the performance of the WORK, CONTRACTOR discovers any conflict, error, ambiguity or discrepancy within the Contract Documents or between the Contract Documents and any provision of any such Law or Regulation applicable to the performance of the WORK or of any such standard, specification, manual or code or of any instruction of any Supplier referred to in paragraph 6.5, the CONTRACTOR shall report it to the ARCHITECT in writing at once, and the CONTRACTOR shall not proceed with the WORK affected thereby (except in an emergency as authorized by the ARCHITECT) until a clarification Field Order, or Change Order to the Contract Documents has been issued.

3.2 ORDER OF PRECEDENCE OF CONTRACT DOCUMENTS

- A. In resolving conflicts resulting from, errors, or discrepancies in any of the Contract Documents, the order of precedence shall be as follows:
 - 1. Permits from other agencies as may be required by law, excepting the definition of "Permittee" in these permits.
 - 2. Field Orders
 - 3. Change Orders
 - 4. ARCHITECT's written interpretations and clarifications.
 - 5. Agreement
 - 6. Addenda
 - 7. CONTRACTOR's Bid (Bid Form)
 - 8. Supplementary General Conditions
 - 9. Notice Inviting Bids
 - 10. Instructions to Bidders

SECTION 00700 - GENERAL CONDITIONS

11. General Conditions
12. Technical Specifications
13. Drawings

B. With reference to the Drawings the order of precedence is as follows:

1. Figures govern over scaled dimensions
2. Detail drawings govern over general drawings
3. Addenda/Change Order drawings govern over contract Drawings
4. Contract Drawings govern over standard details

3.3 AMENDING AND SUPPLEMENTING CONTRACT DOCUMENTS. The Contract Documents may be amended to provide for additions, deletions, and revisions in the WORK or to modify the terms and conditions thereof by a Change Order (pursuant to Article 10 CHANGES IN THE WORK).

3.4 REUSE OF DOCUMENTS. Neither the CONTRACTOR, nor any Subcontractor or Supplier, nor any other person or organization performing any of the WORK under a contract with the OWNER shall have or acquire any title to or ownership rights in any of the Drawings, Technical Specifications, or other documents used on the WORK, and they shall not reuse any of them on the extensions of the Project or any other project without written consent of the OWNER.

ARTICLE 4 AVAILABILITY OF LANDS; PHYSICAL CONDITIONS; REFERENCE POINTS

4.1 AVAILABILITY OF LANDS. The OWNER shall furnish, as indicated in the Contract Documents, the lands upon which the WORK is to be performed, rights-of-way and easements for access thereto, and such other lands which are designated for the use of the CONTRACTOR. Easements for permanent structures or permanent changes in existing facilities will be obtained and paid for by the OWNER, unless otherwise provided in the Contract Documents. Nothing contained in the Contract Documents shall be interpreted as giving the CONTRACTOR exclusive occupancy of the lands or rights-of-way provided. The CONTRACTOR shall provide for all additional lands and access thereto that may be required for temporary construction facilities or storage of materials and equipment; provided, that the CONTRACTOR shall not enter upon nor use any property not under the control of the OWNER until a written temporary construction easement, lease or other appropriate agreement has been executed by the CONTRACTOR and the property owner, and a copy of said agreement furnished to the ARCHITECT prior to said use; and, neither the OWNER nor the ARCHITECT shall be liable for any claims or damages resulting from the CONTRACTOR's unauthorized trespass or use of any such properties.

4.2 PHYSICAL CONDITIONS - SUBSURFACE AND EXISTING STRUCTURES

A. Explorations and Reports. Reference is made to SGC 4.2 Physical Conditions of the Supplementary General Conditions for identification of those reports of explorations and tests of sub-surface conditions at the site that have been utilized by the Architect of Record in the preparation of the Contract Documents. The CONTRACTOR may rely upon the accuracy of the technical data contained in such reports, however, reports are not to be considered complete or comprehensive and nontechnical data, interpretations, and opinions contained in such reports are not to be relied on by the CONTRACTOR. The CONTRACTOR is responsible for any further explorations or tests that may be

SECTION 00700 - GENERAL CONDITIONS

necessary and any interpretation, interpolation, or extrapolation that it makes of any information shown in such reports.

- B. Existing Structures. Reference is made to SGC 4.2 Physical Conditions of the Supplementary General Conditions for identification of those drawings of physical conditions in or relating to existing surface and subsurface structures (except Underground Utilities referred to in Paragraph 4.4 herein) which are at or contiguous to the site that have been utilized by the Architect of Record in the preparation of the Contract Documents. The CONTRACTOR may rely upon the accuracy of the technical data contained in such drawings, however, nontechnical data, interpretations, and opinions contained in such drawings are not to be relied on by the CONTRACTOR. The CONTRACTOR is also responsible for any interpretation, interpolation, or extrapolation that it makes of any information shown in such drawings.

4.3 DIFFERING SITE CONDITIONS

- A. The CONTRACTOR shall promptly upon discovery (but in no event later than 14 days thereafter) and before the following conditions are disturbed, notify the ARCHITECT, in writing of any:
 - 1. Material that the CONTRACTOR believes may be material that is hazardous waste, as defined in Article 1 of these General Conditions, or asbestos, PCB's, petroleum or any other substance or material posing a threat to human or to the environment.
 - 2. Subsurface or latent physical conditions at the site differing from those indicated.
 - 3. Unknown physical conditions at the site of any unusual nature, different materially from those ordinarily encountered and generally recognized as inherent in WORK of the character provided for in the contract.
- B. The ARCHITECT shall promptly investigate the conditions, and if it finds that the conditions do materially so differ, or do involve hazardous waste, and cause a decrease or increase in the CONTRACTOR's cost of, or the time required for, performance of any part of the WORK shall issue a Change Order under the procedures described in the contract.
- C. In the event that a dispute arises between the ARCHITECT and the CONTRACTOR whether the conditions materially differ, or involved hazardous waste or other materials listed above, or cause a decrease or increase in the CONTRACTOR's cost of, or time required for, performance of any part of the WORK, the CONTRACTOR shall not be excused from any scheduled completion date provided for by the contract, but shall proceed with all WORK to be performed under the contract. The CONTRACTOR shall retain any and all rights provided either by contract or by Law which pertain to the resolution of disputes and protests between the contracting parties.

4.4 PHYSICAL CONDITIONS - UNDERGROUND UTILITIES

- A. Indicated. The information and data indicated in the Contract Documents with respect to existing Underground Utilities at or contiguous to the site are based on information and data furnished to the OWNER or the Architect of Record by the owners of such Underground Utilities or by others. Unless it is expressly provided in the Supplementary General Conditions and/or Section 01530 - Protection and Restoration of Existing Facilities, the OWNER and the Architect of Record shall not be responsible for the accuracy or completeness of any such information or data, and the CONTRACTOR shall have full responsibility for reviewing and checking all such information and data, for locating all Underground Utilities indicated in the Contract Documents, for coordination of

SECTION 00700 - GENERAL CONDITIONS

the WORK with the owners of such Underground Utilities during construction, for the safety and protection thereof and repairing any damage thereto resulting from the WORK, the cost of which will be considered as having been included in the Contract Price.

- B. Not Indicated. If an Underground Utility is uncovered or revealed at or contiguous to the site which was not indicated in the Contract Documents and which the CONTRACTOR could not reasonably have been expected to be aware of, the CONTRACTOR shall identify the owner of such Underground Utility and give written notice thereof to that owner and shall notify the ARCHITECT in accordance with the requirements of the Supplementary General Conditions and Section 01530 - Protection and Restoration of Existing Facilities of the General Requirements.

4.5 REFERENCE POINTS

- A. The ARCHITECT will provide one bench mark, near or on the site of the WORK, and will provide two points near or on the site to establish a base line for use by the CONTRACTOR for alignment control. Unless otherwise specified in the General Requirements, the CONTRACTOR shall furnish all other lines, grades, and bench marks required for proper execution of the WORK.
- B. The CONTRACTOR shall preserve all bench marks, stakes, and other survey marks, and in case of their removal or destruction by its own employees or by its subcontractor's employees, the CONTRACTOR shall be responsible for the accurate replacement of such reference points by personnel qualified under the Alaska Statute governing the licensing of architects, engineers, and land surveyors.

4.6 USE OF THE CBJ/STATE LEMON CREEK GRAVEL PIT

- A. On City and Borough of Juneau (CBJ) construction projects, the CBJ may make unclassified material available to CONTRACTORS, from the CBJ/State Lemon Creek gravel pit, at a rate less than charged other customers. CONTRACTORS are not required to use material from the CBJ/State pit and the CBJ makes no guarantee as to the quantity or quality of the available material. For this Project, contact Alec Venechuk, CBJ Material Source Manager, at (907) 586-0874 for the current material rates.
- B. CONTRACTORS proposing to use gravel from the CBJ/State pit are required to be in good standing for all amounts owed to the CBJ, for previous gravel operations, prior to submitting a mining plan for approval. CONTRACTORS using the pit must comply with Allowable Use Permit USE 2008-00061. Failure to meet these requirements, if so subject, shall be sufficient reason to deny use of the CBJ/State pit as a gravel source. To determine if your company is subject to these requirements, contact the CBJ Engineering Department, Gravel Pit Management, at (907) 586-0874.
- C. CONTRACTORS deciding to use material from the CBJ/State pit shall provide an Individual Mining Plan prepared by a professional engineer registered in the State of Alaska. The Individual Mining Plan must be reviewed and approved by the CBJ, prior to commencing operations within the pit. CONTRACTORS shall also secure a Performance Bond to ensure compliance with contract provisions, including any Individual Mining Plan stipulations. The bond shall remain in full force and effect until a release is obtained from the CBJ.
- D. If CONTRACTOR operations for a Project do not exceed 500 tons of material, the CONTRACTOR will not be required to provide an Individual Mining Plan prepared by an engineer, however, the CONTRACTOR must submit an Individual Mining Plan that is in compliance with Allowable Use

SECTION 00700 - GENERAL CONDITIONS

Permit USE 2008-00061 for gravel extraction within the CBJ/State pit. The CONTRACTOR must contact the CBJ Engineering Department for conditions for the extraction.

- E. CONTRACTORS using the CBJ material may do primary dry separation (screening) of materials within the pit. Crushing and washing of material will not be allowed. CONTRACTORS shall account for placement of materials removed from the pit. The CBJ may require CONTRACTORS to cross-check weight tickets, submit to an audit, or participate in other measures required by the CBJ to ensure accountability. Unprocessed overburden removed from the pit will not be weighed. All other material mined will be weighed at the CBJ scale. CONTRACTORS will be responsible for loading and/or screening their own material. If asphalt pavement is removed as part of the WORK, CONTRACTORS shall dispose of the material at a to-be-specified location within the pit area, as directed by the CBJ Gravel Pit Manager, (907) 586-0800 extension 4192.
- F. The gravel pit overhead charge shall be paid to the CBJ by the CONTRACTOR within 60 days after removal of all materials from the pit and prior to requesting and/or receiving final payment. Upon completion of each excavation CONTRACTORS shall notify the CBJ, in writing, in sufficient time to perform a field-compliance examination prior to vacating the pit. Any significant deviation from the stipulations of the Individual Mining Plan identified during the field inspection shall be corrected by the CONTRACTOR prior to release of the bond. A signed release from CBJ will be required prior to releasing the CONTRACTOR's bond.
- G. If asphalt pavement is removed as part of this WORK, the CONTRACTOR shall dispose of the material at the location designated as the Asphalt Storage Facility, or as directed by the ARCHITECT.
- H. The CBJ/State Pit is a seasonal operation. The hours of operation are from 7:00 a.m. to 6:00 p.m., Monday through Friday, from April 1 through October 15 of the year. CONTRACTORS may obtain gravel on weekends, or during the off-season, by applying for a separate agreement with the City and Borough of Juneau Engineering Department. The CONTRACTOR will be responsible for any additional costs incurred during weekend or off-season operations at the gravel pit.
- I. All CONTRACTORS/equipment operators using the CBJ/State Pit shall be in compliance with Federal Mine Safety and Health Administration regulations for quarry and gravel operations.

ARTICLE 5 BONDS AND INSURANCE

5.1 PERFORMANCE, PAYMENT, AND OTHER BONDS

- A. The CONTRACTOR shall furnish Performance and Payment Bonds, each in the amount set forth in the Supplementary General Conditions as security for the faithful performance and payment of all the CONTRACTOR's obligations under the Contract Documents. These bonds shall remain in effect at least until one year after the date of Substantial Completion except as otherwise provided by Law or Regulation or by the Contract Documents. The CONTRACTOR shall also furnish such other Bonds as are required by the Supplementary General Conditions. All Bonds shall be in the form prescribed by the Contract Documents except as provided otherwise by Laws or Regulations, and shall be executed by such sureties as are named in the current list of "Companies Holding Certificates of Authority as Acceptable Sureties on Federal Bonds and as Acceptable Reinsuring Companies" as published in Circular 570 (amended) by the Audit Staff, Bureau of Government Financial Operations, U.S. Treasury Department. All Bonds signed by an agent must be accompanied by a certified copy of such agent's authority to act.

SECTION 00700 - GENERAL CONDITIONS

- B. If the surety on any Bond furnished by the CONTRACTOR is declared bankrupt or becomes insolvent or its right to do business is terminated in any state where any part of the WORK is located, the CONTRACTOR shall within 7 days thereafter substitute another Bond and Surety, which must be acceptable to the OWNER.
- C. All Bonds required by the Contract Documents to be purchased and maintained by CONTRACTOR shall be obtained from surety companies that are duly licensed or authorized in the State of Alaska to issue Bonds for the limits so required. Such surety companies shall also meet such additional requirements and qualifications as may be provided in the Supplementary General Conditions.

5.2 INSURANCE

- A. The CONTRACTOR shall purchase and maintain the insurance required under this paragraph. Such insurance shall include the specific coverages set out herein and be written for not less than the limits of liability and coverages provided in the Supplementary General Conditions, or required by law, whichever are greater. All insurance shall be maintained continuously during the life of the Agreement up to the date of Final Completion and at all times thereafter when the CONTRACTOR may be correcting, removing, or replacing Defective WORK in accordance with Paragraph 13.6, but the CONTRACTOR's liabilities under this Agreement shall not be deemed limited in any way to the insurance coverage required.
- B. All insurance required by the Contract Documents to be purchased and maintained by the CONTRACTOR shall be obtained from insurance companies that are duly licensed or authorized in the State of Alaska to issue insurance policies for the limits and coverages so required. Such insurance companies shall have a current Best's Rating of at least an "A" (Excellent) general policy holder's rating and a Class VII financial size category and shall also meet such additional requirements and qualifications as may be provided in the Supplementary General Conditions.
- C. The CONTRACTOR shall furnish the OWNER with certificates showing the type, amount, class of operations covered, effective dates and dates of expiration of policies. All of the policies of insurance so required to be purchased and maintained (or the certificates or other evidence thereof) shall contain a provision or endorsement that the coverage afforded will not be cancelled, reduced in coverage, or renewal refused until at least 30 days' prior written notice has been given to the OWNER by certified mail. All such insurance required herein (except for Workers' Compensation and Employer's Liability) shall name the OWNER, its Consultants and subconsultants and their officers, directors, agents, and employees as "additional insureds" under the policies. The CONTRACTOR shall purchase and maintain the following insurance:
 - 1. Workers' Compensation and Employer's Liability. This insurance shall protect the CONTRACTOR against all claims under applicable state workers' compensation laws. The CONTRACTOR shall also be protected against claims for injury, disease, or death of employees which, for any reason, may not fall within the provisions of a Workers' Compensation law. This policy shall include an "all states" endorsement. The CONTRACTOR shall require each Subcontractor similarly to provide Workers' Compensation Insurance for all of the latter's employees to be engaged in such work unless such employees are covered by the protection afforded by the CONTRACTOR's Workers' Compensation Insurance. In case any class of employees is not protected, under the Workers' Compensation Statute, the

SECTION 00700 - GENERAL CONDITIONS

- CONTRACTOR shall provide and shall cause each subcontractor to provide adequate employer's liability insurance for the protection of such of its employees as are not otherwise protected.
2. Commercial General Liability. This insurance shall be written in comprehensive form and shall protect the CONTRACTOR against all claims arising from injuries to persons other than its employees or damage to property of the OWNER or others arising out of any act or omission of the CONTRACTOR or its agents, employees, or Subcontractors. The policy shall contain no exclusions for any operations within the scope of this contract.
 3. Comprehensive Automobile Liability. This insurance shall be written in comprehensive form and shall protect the CONTRACTOR against all claims for injuries to members of the public and damage to property of others arising from the use of motor vehicles, and shall cover operation on or off the site of all motor vehicles licensed for highway use, whether they are owned, non-owned, or hired. Coverage for hired motor vehicles should include endorsement covering liability assumed under this contract.
 4. Subcontractor's Public Liability and Property Damage Insurance and Vehicle Liability Insurance. The CONTRACTOR shall either require each of its Subcontractors to procure and to maintain Subcontractor's Commercial General Liability and Property Damage Insurance and Vehicle Liability Insurance of the type and in the amounts specified in the Supplementary General Conditions or insure the activities of its subcontractors in the CONTRACTOR's own policy, in like amount.
 5. Builder's Risk. This insurance shall be of the "all risks" type, shall be written in completed value form, and shall protect the CONTRACTOR, the OWNER, and the ARCHITECT, against risks of damage to buildings, structures, and materials and equipment. The amount of such insurance shall be not less than the insurable value of the WORK at completion. Builder's risk insurance shall provide for losses to be payable to the CONTRACTOR and the OWNER, as their interests may appear. The policy shall contain a provision that in the event of payment for any loss under the coverage provided, the insurance company shall have no rights of recovery against the CONTRACTOR, the OWNER, and the ARCHITECT. The Builder's Risk policy shall insure against all risks of direct physical loss or damage to property from any external cause including flood and earthquake. Allowable exclusions, if any, shall be as specified in the Supplementary General Conditions.

ARTICLE 6 CONTRACTOR'S RESPONSIBILITIES

6.1 SUPERVISION AND SUPERINTENDENCE

- A. The CONTRACTOR shall supervise, inspect, and direct the WORK competently and efficiently, devoting such attention thereto and applying such skills and expertise as may be necessary to perform the WORK in accordance with the Contract Documents. The CONTRACTOR shall be solely responsible for the means, methods, techniques, sequences, and procedures of construction and safety precautions and programs incidental thereto. The CONTRACTOR shall be responsible to see that the completed WORK complies accurately with the Contract Documents.
- B. The CONTRACTOR shall designate in writing and keep on the work site at all times during its progress a technically qualified, English-speaking superintendent, who is an employee of the CONTRACTOR and who shall not be replaced without written notice to the OWNER and the ARCHITECT. The superintendent will be the CONTRACTOR's representative at the site and shall

SECTION 00700 - GENERAL CONDITIONS

have authority to act on behalf of the CONTRACTOR. All communications given to the superintendent shall be as binding as if given to the CONTRACTOR. The CONTRACTOR shall issue all its communications to the OWNER through the ARCHITECT and the ARCHITECT only.

- C. The CONTRACTOR's superintendent shall be present at the site of the WORK at all times while WORK is in progress. Failure to observe this requirement shall be considered suspension of the WORK by the CONTRACTOR until such time as such superintendent is again present at the site.

6.2 LABOR, MATERIALS, AND EQUIPMENT

- A. The CONTRACTOR shall provide competent, suitably qualified personnel to survey and lay out the WORK and perform construction as required by the Contract Documents. The CONTRACTOR shall furnish, erect, maintain, and remove the construction plant and any temporary works as may be required. The CONTRACTOR shall at all times maintain good discipline and order at the site. Except in connection with the safety or protection of persons or the WORK or property at the site or adjacent thereto, and except as otherwise indicated in the Contract Documents, all WORK at the site shall be performed during regular working hours, and the CONTRACTOR will not permit overtime WORK or the performance of WORK on Saturday, Sunday, or any legal holiday without the OWNER's written consent. The CONTRACTOR shall apply for this consent through the ARCHITECT.
- B. Except as otherwise provided in this Paragraph, the CONTRACTOR shall receive no additional compensation for overtime WORK, i.e., work in excess of 8 hours in any one calendar day or 40 hours in any one calendar week, even though such overtime WORK may be required under emergency conditions and may be ordered by the ARCHITECT in writing. Additional compensation will be paid the CONTRACTOR for overtime WORK only in the event extra WORK is ordered by the ARCHITECT and the Change Order specifically authorizes the use of overtime WORK and then only to such extent as overtime wages are regularly being paid by the CONTRACTOR for overtime WORK of a similar nature in the same locality.
- C. All costs of inspection and testing performed during overtime WORK by the CONTRACTOR which is allowed solely for the convenience of the CONTRACTOR shall be borne by the CONTRACTOR. The ARCHITECT shall have the authority to deduct the cost of all such inspection and testing from any partial payments otherwise due to the CONTRACTOR.
- D. Unless otherwise specified in the Contract Documents, the CONTRACTOR shall furnish and assume full responsibility for all materials, equipment, labor, transportation, construction equipment and machinery, tools, appliances, fuel, power, light, heat, telephone, water, sanitary facilities, and all other facilities and incidentals necessary for the furnishing, performance, testing, start-up, and completion of the WORK.
- E. All materials and equipment to be incorporated into the WORK shall be of good quality and new, except as otherwise provided in the Contract Documents. All warranties and guarantees specifically called for by the Specifications shall expressly run to the benefit of the OWNER. If required by the ARCHITECT, the CONTRACTOR shall furnish satisfactory evidence (including reports of required tests) as to the kind and quality of materials and equipment. All materials and equipment shall be applied, installed, connected, erected, used, cleaned, and conditioned in accordance with the instructions of the applicable Supplier except as otherwise provided in the Contract Documents; but no provisions of any such instructions will be effective to assign to the ARCHITECT, or any of the Architect's of Record consultants, agents, or employees, any duty or authority to supervise or direct the

SECTION 00700 - GENERAL CONDITIONS

furnishing or performance of the WORK or any duty or authority to undertake responsibility contrary to the provisions of Paragraphs 9.9C and 9.9D.

- F. The CONTRACTOR shall at all times employ sufficient labor and equipment for prosecuting the several classes of WORK to full completion in the manner and time set forth in and required by these specifications. All workers shall have sufficient skill and experience to properly perform the WORK assigned to them. Workers engaged in special WORK, or skilled WORK, shall have sufficient experience in such WORK and in the operation of the equipment required to perform all WORK, properly and satisfactorily.
 - G. Any person employed by the CONTRACTOR or by any SUBCONTRACTOR who, in the opinion of the ARCHITECT, does not perform the WORK in a proper and skillful manner, or is intemperate or disorderly shall, at the written request of the ARCHITECT, be removed forthwith by the CONTRACTOR or Subcontractor employing such person, and shall not be employed again in any portion of the WORK without the approval of the ARCHITECT. Should the CONTRACTOR fail to remove such person or persons as required above, or fail to furnish suitable and sufficient personnel for the proper prosecution of the WORK, the ARCHITECT may suspend the WORK by written notice until such orders are complied with.
- 6.3 ADJUSTING PROGRESS SCHEDULE. The CONTRACTOR shall submit monthly updates of the progress schedule to the ARCHITECT for acceptance in accordance with the provisions in Section 01300 - CONTRACTOR Submittals in the General Requirements.
- 6.4 SUBSTITUTES OR "OR-EQUAL" ITEMS. The CONTRACTOR shall submit proposed substitutes or "or-equal" items in accordance with the provisions in Section 01300 - CONTRACTOR Submittals in the General Requirements.
- 6.5 CONCERNING SUBCONTRACTORS, SUPPLIERS, AND OTHERS. The CONTRACTOR shall be responsible to the OWNER and the ARCHITECT of Record for the acts and omissions of its subcontractors and their employees to the same extent as CONTRACTOR is responsible for the acts and omissions of its own employees. Nothing contained in this Paragraph shall create any contractual relationship between any subcontractor and the OWNER or the ARCHITECT nor relieve the CONTRACTOR of any liability or obligation under the contract.
- 6.6 PERMITS
- A. Unless otherwise provided in the Supplementary General Conditions, the CONTRACTOR shall obtain and pay for all construction permits and licenses from the agencies having jurisdiction, including the furnishing of insurance and Bonds if required by such agencies. The enforcement of such requirements under this contract shall not be made the basis for claims for additional compensation. The OWNER shall assist the CONTRACTOR, when necessary, in obtaining such permits and licenses. The CONTRACTOR shall pay all governmental charges and inspection fees necessary for the prosecution of the WORK, which are applicable at the time of opening of Bids. The CONTRACTOR shall pay all charges of utility owners for connections to the WORK.
 - B. These Contract Documents may require that the WORK be performed within the conditions and/or requirements of local, state and/or federal permits. These permits may be bound within the Contract Documents, included within the Contract Documents by reference, or included as part of the WORK, as designated in this Section. The CONTRACTOR is responsible for completing the WORK required

SECTION 00700 - GENERAL CONDITIONS

for compliance with all permit requirements; this WORK is incidental to other items in the Contract Documents. Any reference to the PERMITTEE in the permits shall mean the CONTRACTOR. If any permits were acquired by the OWNER, this action was done to expedite the start of construction. If the CONTRACTOR does not complete the WORK within the specified permit window, the CONTRACTOR shall be responsible for the permit extension, and for completing any additional requirements placed upon the permit.

- 6.7 PATENT FEES AND ROYALTIES. The CONTRACTOR shall pay all license fees and royalties and assume all costs incident to the use in the performance of the WORK or the incorporation in the WORK of any invention, design, process, product, software or device which is the subject of patent rights or copyrights held by others. If a particular invention, design, process, product, or device is specified in the Contract Documents for use in the performance of the WORK and if to the actual knowledge of the OWNER or the Architect of Record its use is subject to patent rights or copyrights calling for the payment of any license fee or royalty to others, the existence of such rights shall be disclosed by the OWNER in the Contract Documents. The CONTRACTOR shall indemnify, defend and hold harmless the OWNER and the Architect of Record and anyone directly or indirectly employed by either of them from and against all claims, damages, losses, and expenses (including attorneys' fees and court costs) arising out of any infringement of patent rights or copyrights incident to the use in the performance of the WORK or resulting from the incorporation in the WORK of any invention, design, process, product, or device not specified in the Contract Documents, and shall defend all such claims in connection with any alleged infringement of such rights.
- 6.8 LAWS AND REGULATIONS. The CONTRACTOR shall observe and comply with all federal, state, and local laws, ordinances, codes, orders, and regulations which in any manner affect those engaged or employed on the WORK, the materials used in the WORK, or the conduct of the WORK. If any discrepancy or inconsistency should be discovered in this contract in relation to any such law, ordinance, code, order, or regulation, the CONTRACTOR shall report the same in writing to the ARCHITECT. The CONTRACTOR shall indemnify, defend, and hold harmless the OWNER, the Architect of Record, and their officers, agents, and employees against all claims or liability arising from violation of any such law, ordinance, code, order, or regulation, whether by CONTRACTOR or by its employees, Subcontractors, or third parties. Any particular law or regulation specified or referred to elsewhere in the Contract Documents shall not in any way limit the obligation of the CONTRACTOR to comply with all other provisions of federal, state, and local laws and regulations.
- 6.9 TAXES. The CONTRACTOR shall pay all sales, consumer, use, and other similar taxes required to be paid by the CONTRACTOR in accordance with the Laws and Regulations of the place of the Project which are applicable during the performance of the WORK.
- 6.10 USE OF PREMISES. The CONTRACTOR shall confine construction equipment, the storage of materials and equipment, and the operations of workers to (1) the Project site, (2) the land and areas identified in and permitted by the Contract Documents, and (3) the other land and areas permitted by Laws and Regulations, rights-of-way, permits, leases and easements. The CONTRACTOR shall assume full responsibility for any damage to any such land or area, or to the owner or occupant thereof or of any land or areas contiguous thereto, resulting from the performance of the WORK. Should any claim be made against the OWNER or the Architect of Record by any such owner or occupant because of the performance of the WORK, the CONTRACTOR shall promptly attempt to settle with such other party by agreement or otherwise resolve the claim through litigation. The CONTRACTOR shall, to the fullest extent permitted by Laws and Regulations, indemnify, defend, and hold the OWNER and the Architect of Record harmless from and against all claims, damages, losses, and

SECTION 00700 - GENERAL CONDITIONS

expenses (including, but not limited to, fees of Architect's of Records attorneys, and other professionals and court costs) arising directly, indirectly, or consequentially out of any action, legal or equitable, brought by any such owner or occupant against the OWNER, the Architect of Record, their consultants, sub-consultants, and the officers, directors, employees and agents of each and any of them to the extent caused by or based upon the CONTRACTOR's performance of the WORK.

6.11 SAFETY AND PROTECTION

- A. The CONTRACTOR shall be responsible for initiating, maintaining, and supervising all safety precautions and programs in connection with the WORK. The CONTRACTOR shall take all necessary precautions for the safety of, and shall provide the necessary protection to prevent damage, injury or loss to:
 - 1. all employees on the WORK and other persons and organizations who may be affected thereby;
 - 2. all the WORK and materials and equipment to be incorporated therein, whether in storage on or off the site; and
 - 3. other property at the site or adjacent thereto, including trees, shrubs, lawns, walks, pavements, roadways, structures, and utilities not designated for removal, relocation, or replacement in the course of construction.
- B. The CONTRACTOR shall comply with all applicable Laws and Regulations whether referred to herein or not) of any public body having jurisdiction for the safety of persons or property or to protect them from damage, injury, or loss and shall erect and maintain all necessary safeguards for such safety and protection. The CONTRACTOR shall notify owners of adjacent property and utilities when prosecution of the WORK may affect them, and shall cooperate with them in the protection, removal, relocation, and replacement of their property.
- C. The CONTRACTOR shall designate a qualified and experienced safety representative at the site whose duties and responsibilities shall be the prevention of accidents and the maintaining and supervising of safety precautions and program.
- D. Materials that contain hazardous substances or mixtures may be required on the WORK. A Material Safety Data Sheet (MSDS) shall be requested by the CONTRACTOR from the manufacturer of any hazardous product used.
- E. Material usage shall be accomplished with strict adherence to all safety requirements and all manufacturer's warnings and application instructions listed on the Material Safety Data Sheet and on the product container label.
- F. The CONTRACTOR shall be responsible for coordinating communications on any exchange of Material Safety Data Sheets or other hazardous material information that is required to be made available to, or exchanged between, or among, employers at the site in accordance with Laws or Regulations.
- G. The CONTRACTOR shall notify the ARCHITECT if it considers a specified product or its intended usage to be unsafe. This notification must be given to the ARCHITECT prior to the product being ordered, or if provided by some other party, prior to the product being incorporated in the WORK.

SECTION 00700 - GENERAL CONDITIONS

6.12 SHOP DRAWINGS AND SAMPLES

- A. After checking and verifying all field measurements and after complying with applicable procedures specified in the General Requirements, the CONTRACTOR shall submit to the ARCHITECT for review, all Shop Drawings in accordance with Section 01300 - CONTRACTOR Submittals in the General Requirements.
- B. The CONTRACTOR shall also submit to the ARCHITECT for review all samples in accordance with Section 01300 - CONTRACTOR Submittals in the General Requirements.
- C. Before submittal of each Shop Drawing or sample, the CONTRACTOR shall have determined and verified all quantities, dimensions, specified performance criteria, installation requirements, materials, catalog numbers, and similar data with respect thereto and reviewed or coordinated each Shop Drawing or sample with other Shop Drawings and samples and with the requirements of the WORK and the Contract Documents.

6.13 CONTINUING THE WORK. The CONTRACTOR shall carry on the WORK and adhere to the progress schedule during all disputes or disagreements with the OWNER. No WORK shall be delayed or postponed pending resolution of any disputes or disagreements, except as the CONTRACTOR and the OWNER may otherwise agree in writing.

6.14 INDEMNIFICATION

- A. To the fullest extent permitted by Laws and Regulations, the CONTRACTOR shall indemnify, defend, and hold harmless the OWNER, the Architect of Record, their consultants, sub-consultants and the officers, directors, employees, and agents of each and any of them, against and from all claims and liability arising under, by reason of or incidentally to the contract or any performance of the WORK, but not from the sole negligence or willful misconduct of the OWNER, and the Architect of Record. Such indemnification by the CONTRACTOR shall include but not be limited to the following:
 - 1. Liability or claims resulting directly or indirectly from the negligence or carelessness of the CONTRACTOR, its employees, or agents in the performance of the WORK, or in guarding or maintaining the same, or from any improper materials, implements, or appliances used in its construction, or by or on account of any act or omission of the CONTRACTOR, its employees, agents, or third parties;
 - 2. Liability or claims arising directly or indirectly from bodily injury, occupational sickness or disease, or death of the CONTRACTOR's or Subcontractor's own employees engaged in the WORK resulting in actions brought by or on behalf of such employees against the OWNER, or the Architect of Record;
 - 3. Liability or claims arising directly or indirectly from or based on the violation of any law, ordinance, regulation, order, or decree, whether by the CONTRACTOR, its employees, or agents;
 - 4. Liability or claims arising directly or indirectly from the use or manufacture by the CONTRACTOR, its employees, or agents in the performance of this contract of any copyrighted or non-copyrighted composition, secret process, patented or non-patented invention, computer software, article, or appliance, unless otherwise specifically stipulated in this contract.

SECTION 00700 - GENERAL CONDITIONS

5. Liability or claims arising directly or indirectly from the breach of any warranties, whether express or implied, made to the ARCHITECT, OWNER or any other parties by the CONTRACTOR, its employees, or agents;
 6. Liabilities or claims arising directly or indirectly from the willful or criminal misconduct of the CONTRACTOR, its employees, or agents; and,
 7. Liabilities or claims arising directly or indirectly from any breach of the obligations assumed herein by the CONTRACTOR.
- B. The CONTRACTOR shall reimburse the OWNER and the Architect of Record for all costs and expenses, (including but not limited to fees and charges of Architects of Record, attorneys, and other professionals and court costs including all costs of appeals) incurred by the OWNER, and the Architect of Record in enforcing the provisions of this Paragraph 6.14.
- C. The indemnification obligation under this Paragraph 6.14 shall not be limited in any way by any limitation of the amount or type of damages, compensation, or benefits payable by or for the CONTRACTOR or any such Subcontractor or other person or organization under workers' compensation acts, disability benefit acts, or other employee benefit acts.
- 6.15 CONTRACTOR'S DAILY REPORTS. The CONTRACTOR shall complete a daily report indicating total manpower for each construction trade, major equipment on site, each Subcontractor's manpower, weather conditions, etc., involved in the performance of the WORK. The daily report shall be completed on forms provided by the ARCHITECT and shall be submitted to the ARCHITECT at the conclusion of each WORK day. The report should comment on the daily progress and status of the WORK within each major component of the WORK. These components will be decided by the ARCHITECT. The CONTRACTOR shall record the name, affiliation, time of arrival and departure, and reason for visit for all visitors to the location of the WORK.
- 6.16 ASSIGNMENT OF CONTRACT. The CONTRACTOR shall not assign, sublet, sell, transfer, or otherwise dispose of the contract or any portion thereof, or its right, title, or interest therein, or obligations thereunder, without the written consent of the OWNER except as imposed by law. If the CONTRACTOR violates this provision, the contract may be terminated at the option of the OWNER. In such event, the OWNER shall be relieved of all liability and obligations to the CONTRACTOR and to its assignee or transferee, growing out of such termination.
- 6.17 CONTRACTOR'S RESPONSIBILITY FOR UTILITY PROPERTY AND SERVICES. It is understood that any turn-on, or turn-off line locates and any other WORK or assistance necessary by the CBJ Water Utilities Division, will be at the CONTRACTOR's expense unless otherwise stated in the bid documents. All cost must be agreed to prior to any related actions, and will be considered incidental to the Project cost. Billing to the CONTRACTOR will be direct from the CBJ Water Utilities Division.
- 6.18 OPERATING WATER SYSTEM VALVES
- A. The CONTRACTOR shall submit a written request, to the ARCHITECT, for approval to operate any valve on any in-service section of the CBJ water system. The request must be submitted at least 24-hours prior to operating any valves. The CBJ Water Utilities Division reserves the right to approve or deny the request. The request shall specifically identify each valve to be operated, the time of operation, and the operation to be performed. The CONTRACTOR shall obtain the written approval of the ARCHITECT for any scheduled operation before operating any valve.

SECTION 00700 - GENERAL CONDITIONS

- B. The CONTRACTOR shall be responsible for all damages, both direct and consequential, to the OWNER or any other party, caused by unauthorized operation of any valve of the CBJ water system.
- 6.19 CONTRACTOR'S WORK SCHEDULE LIMITATIONS. Construction of Buildings and Projects. It is unlawful to operate any pile driver, power shovel, pneumatic hammer, derrick, power hoist, or similar heavy construction equipment before 7:00 a.m. or after 10:00 p.m., Monday through Friday, or before 9:00 a.m. or after 10:00 p.m., Saturday and Sunday, unless a permit shall first be obtained from the City and Borough Building Official. Such permit shall be issued by the Building Official only upon a determination that such operation during hours not otherwise permitted hereunder is necessary and will not result in unreasonable disturbance to surrounding residents.

ARTICLE 7 OTHER WORK

7.1 RELATED WORK AT SITE

- A. The OWNER may perform other work related to the Project at the site by the OWNER's own forces, have other work performed by utility owners, or let other direct contracts therefor which may contain General Conditions similar to these. If the fact that such other work is to be performed was not noted in the Contract Documents, written notice thereof will be given to the CONTRACTOR prior to starting any such other work.
- B. The CONTRACTOR shall afford each other contractor who is a party to such a direct contract and each utility owner (or the OWNER, if the OWNER is performing the additional work with the OWNER's employees) proper and safe access to the site and a reasonable opportunity for the introduction and storage of materials and equipment and the execution of such work, and shall properly connect and coordinate with their WORK. The CONTRACTOR shall do all cutting, fitting, and patching of the WORK that may be required to make its several parts come together properly and integrate with such other work. The CONTRACTOR shall not endanger any work of others by cutting, excavating, or otherwise altering their work and will only cut or alter their work with the written consent of the ARCHITECT and the others whose work will be affected.
- C. If the proper execution or results of any part of the CONTRACTOR's WORK depends upon the work of any such other contractor or utility owner (or OWNER), the CONTRACTOR shall inspect and report to the ARCHITECT in writing any delays, defects, or deficiencies in such other work that render it unavailable or unsuitable for such proper execution and results. The CONTRACTOR's failure to report such delays, defects, or deficiencies will constitute an acceptance of the other work as fit and proper for integration with the CONTRACTOR's WORK except for latent or nonapparent defects and deficiencies in the other work.

- 7.2 COORDINATION. If the OWNER contracts with others for the performance of other work on the Project at the site, the person or organization who will have authority and responsibility for coordination of the activities among the various prime contractors will be identified in the Supplementary General Conditions, and the specific matters to be covered by such authority and responsibility will be itemized and the extent of such authority and responsibilities will be provided in the Supplementary General Conditions.

SECTION 00700 - GENERAL CONDITIONS

ARTICLE 8 OWNER'S RESPONSIBILITIES

8.1 COMMUNICATIONS

- A. The OWNER shall issue all its communications to the CONTRACTOR through the ARCHITECT.
- B. The CONTRACTOR shall issue all its communications to the OWNER through the ARCHITECT.

8.2 PAYMENTS. The OWNER shall make payments to the CONTRACTOR as provided in Paragraphs 14.5, 14.8, 14.9 and 14.10.

8.3 LANDS, EASEMENTS, AND SURVEYS. The OWNER's duties in respect of providing lands and easements and providing surveys to establish reference points are set forth in Paragraphs 4.1 and 4.5.

8.4 CHANGE ORDERS. The OWNER shall execute Change Orders as indicated in Paragraph 10.1F.

8.5 INSPECTIONS AND TESTS. The OWNER's responsibility in respect of inspections, tests, and approvals is set forth in Paragraph 13.3.

8.6 SUSPENSION OF WORK. In connection with the OWNER's right to stop WORK or suspend WORK, see Paragraphs 13.4 and 15.1.

8.7 TERMINATION OF AGREEMENT. Paragraphs 15.2 and 15.3 deal with the OWNER's right to terminate services of the CONTRACTOR.

ARTICLE 9 ARCHITECT'S STATUS DURING CONSTRUCTION

9.1 OWNER'S REPRESENTATIVE. The ARCHITECT will be the OWNER's representative during the construction period. The duties and responsibilities and the limitations of authority of the ARCHITECT as the OWNER's representative during construction are set forth in the Contract Documents.

9.2 VISITS TO SITE. The ARCHITECT will make visits to the site during construction to observe the progress and quality of the WORK and to determine, in general, if the WORK is proceeding in accordance with the Contract Documents. Exhaustive or continuous on-site inspections to check the quality or quantity of the WORK will not be required of the ARCHITECT. The ARCHITECT will not, during such visits, or as a result of such observations of the CONTRACTOR's WORK in progress, supervise, direct, or have control over the CONTRACTOR's WORK.

9.3 PROJECT REPRESENTATION. The ARCHITECT may furnish an Inspector to assist in observing the performance of the WORK. The duties, responsibilities, and limitations of authority of any such Inspector and assistants will be as provided in the Supplementary General Conditions.

9.4 CLARIFICATIONS AND INTERPRETATIONS. The ARCHITECT will issue with reasonable promptness such written clarifications or interpretations of the requirements of the Contract Documents (in the form of Drawings or otherwise) as the ARCHITECT may determine necessary, which shall be consistent with or reasonably inferable from the overall intent of the Contract Documents.

SECTION 00700 - GENERAL CONDITIONS

- 9.5 AUTHORIZED VARIATIONS IN WORK. The ARCHITECT may authorize variations in the WORK from the requirements of the Contract Documents. These may be accomplished by a Field Order and will require the CONTRACTOR to perform the WORK involved in a manner that minimizes the impact to the WORK and the contract completion date. If the CONTRACTOR believes that a Field Order justifies an increase in the Contract Price or an extension of the Contract Time, the CONTRACTOR may make a claim therefor as provided in Article 11 or 12.
- 9.6 REJECTING OR ACCEPTING DEFECTIVE WORK. The ARCHITECT will have authority to reject or accept WORK which the ARCHITECT believes to be defective and will also have authority to require special inspection or testing of the WORK as provided in Paragraph 13.3G, whether or not the WORK is fabricated, installed, or completed.
- 9.7 CONTRACTOR SUBMITTALS, CHANGE ORDERS, AND PAYMENTS
- A. In accordance with the procedures set forth in the General Requirements, the ARCHITECT will review all CONTRACTOR submittals, including Shop Drawings, samples, substitutes, or "or equal" items, etc., in order to determine if the items covered by the submittals will, after installation or incorporation in the WORK, conform to the requirements of the Contract Documents and be compatible with the design concept of the completed Project as a functioning whole as indicated by the Contract Documents. The ARCHITECT's review will not extend to means, methods, techniques, sequences or procedures of construction or to safety precautions or programs incident thereto.
 - B. In connection with the ARCHITECT's responsibilities as to Change Orders, see Articles 10, 11, and 12.
 - C. In connection with the ARCHITECT's responsibilities in respect of Applications for Payment, see Article 14.
- 9.8 DECISIONS ON DISPUTES
- A. The ARCHITECT will be the initial interpreter of the requirements of the Contract Documents and judge of the acceptability of the WORK thereunder. Claims, disputes, and other matters relating to the acceptability of the WORK; the interpretation of the requirements of the Contract Documents pertaining to the performance of the WORK; and those claims under Articles 11 and 12 in respect to changes in the Contract Price or Contract Time will be referred initially to the ARCHITECT in writing with a request for formal decision in accordance with this paragraph, which the ARCHITECT will render in writing within 30 days of receipt of the request. Written notice of each such claim, dispute, and other matter will be delivered by the CONTRACTOR to the ARCHITECT promptly (but in no event later than 30 days) after the occurrence of the event giving rise thereto. Written supporting data will be submitted to the ARCHITECT within 60 days after such occurrence unless the ARCHITECT allows an additional period of time to ascertain more accurate data in support of the claim.
 - B. The rendering of a decision by the ARCHITECT with respect to any such claim, dispute, or other matter (except any which have been waived by the making or acceptance of final payment as provided in Paragraph 14.12) will be a condition precedent to any exercise by the OWNER or the CONTRACTOR of such rights or remedies as either may otherwise have under the Contract Documents or by Law or Regulations in respect of any such claim, dispute, or other matter.

SECTION 00700 - GENERAL CONDITIONS

9.9 LIMITATION ON ARCHITECT'S RESPONSIBILITIES

- A. Neither the ARCHITECT's authority to act under this Article or other provisions of the Contract Documents nor any decision made by the ARCHITECT in good faith either to exercise or not exercise such authority shall give rise to any duty or responsibility of the ARCHITECT to the CONTRACTOR, any Subcontractor, any Supplier, any surety for any of them, or any other person or organization performing any of the WORK.
- B. Whenever in the Contract Documents the terms "as ordered," "as directed," "as required," "as allowed," "as reviewed," "as approved," or terms of like effect or import are used, or the adjectives "reasonable," "suitable," "acceptable," "proper," or "satisfactory" or adjectives of like effect or import are used to describe a requirement, direction, review, or judgment of the ARCHITECT as to the WORK, it is intended that such requirement, direction, review, or judgment will be solely to evaluate the WORK for compliance with the requirements of the Contract Documents, and conformance with the design concept of the completed Project as a functioning whole as indicated by the Contract Documents, unless there is a specific statement indicating otherwise. The use of any such term or adjective shall not be effective to assign to the ARCHITECT any duty or authority to supervise or direct the performance of the WORK or any duty or authority to undertake responsibility contrary to the provisions of Paragraph 9.9C or 9.9D.
- C. The ARCHITECT will not supervise, direct, control, or have authority over or be responsible for the CONTRACTOR's means, methods, techniques, sequences, or procedures of construction, or the safety precautions and programs incident thereto, or for any failure of the CONTRACTOR to comply with Laws and Regulations, applicable to the performance of the WORK. The ARCHITECT will not be responsible for the CONTRACTOR's failure to perform the WORK in accordance with the Contract Documents.
- D. The ARCHITECT will not be responsible for the acts or omissions of the CONTRACTOR nor of any Subcontractor, Supplier, or any other person or organization performing any of the WORK.

ARTICLE 10 CHANGES IN THE WORK

10.1 GENERAL

- A. Without invalidating the Agreement and without notice to any surety, the OWNER may at any time or from time to time, order additions, deletions, or revisions in the WORK; these will be authorized by a written Field Order and/or a Change Order issued by the ARCHITECT.
- B. If the CONTRACTOR believes that it is entitled to an increase or decrease in the Contract Price, or an extension or shortening in the Contract Time as the result of a Field Order, a claim may be made as provided in Articles 11 and 12.
- C. If the OWNER and CONTRACTOR agree on the value of any WORK, or the amount of Contract Time that should be allowed as a result of a Field Order, upon receiving written notice from the ARCHITECT, the CONTRACTOR shall proceed so as to minimize the impact on and delays to the WORK pending the issuance of a Change Order.
- D. If the OWNER and the CONTRACTOR are unable to agree as to the extent, if any, of an increase or decrease in the Contract Price or an extension or shortening of the Contract Time that should be

SECTION 00700 - GENERAL CONDITIONS

allowed as a result of a Field Order, the ARCHITECT can direct the CONTRACTOR to proceed on the basis of Time and Materials so as to minimize the impact on and delays to the WORK, and a claim may be made therefor as provided in Articles 11 and 12.

- E. The CONTRACTOR shall not be entitled to an increase in the Contract Price nor an extension of the Contract Time with respect to any WORK performed that is not required by the Contract Documents as amended, modified, supplemented by Change Order, except in the case of an emergency and except in the case of uncovering WORK as provided in Paragraph 13.3G.
- F. The OWNER and the CONTRACTOR shall execute appropriate Change Orders covering:
 - 1. changes in the WORK which are ordered by the OWNER pursuant to Paragraph 10.1A;
 - 2. changes required because of acceptance of Defective WORK under Paragraph 13.7;
 - 3. changes in the Contract Price or Contract Time which are agreed to by the parties; or
 - 4. changes in the Contract Price or Contract Time which embody the substance of any written decision rendered by the ARCHITECT pursuant to Paragraph 9.8.
- G. If notice of any change is required by the provisions of any Bond to be given to a surety, the giving of any such notice will be the CONTRACTOR's responsibility, and the amount of each applicable Bond shall be adjusted accordingly.

10.2 ALLOWABLE QUANTITY VARIATIONS

- A. In the event of an increase or decrease in bid item quantity of a unit price contract, the total amount of WORK actually done or materials or equipment furnished shall be paid for according to the unit price established for such WORK under the Contract Documents, wherever such unit price has been established; provided, that an adjustment in the Contract Price may be made for changes which result in an increase or decrease in excess of 25% of the estimated quantity of any major item of the WORK. Major Item is defined as any bid item amount that is ten percent (10%) or more of the total contract amount.
- B. In the event a part of the WORK is to be entirely eliminated and no lump sum or unit price is named in the Contract Documents to cover such eliminated WORK, the price of the eliminated WORK shall be agreed upon in writing by the OWNER and the CONTRACTOR. If the OWNER and the CONTRACTOR fail to agree upon the price of the eliminated WORK, said price shall be determined in accordance with the provisions of Article 11.

ARTICLE 11 CHANGE OF CONTRACT PRICE

11.1 GENERAL

- A. The Contract Price constitutes the total compensation payable to the CONTRACTOR for performing the WORK. All duties, responsibilities, and obligations assigned to or undertaken by the CONTRACTOR to complete the WORK shall be at its expense without change in the Contract Price.
- B. The Contract Price may only be changed by a Change Order. Any claim for an increase in the Contract Price shall be based on written notice delivered by the CONTRACTOR to the ARCHITECT promptly (but in no event later than 30 days) after the start of the occurrence or the event giving rise to the claim

SECTION 00700 - GENERAL CONDITIONS

and stating the general nature of the claim. Notice of the amount of the claim with supporting data shall be delivered within 60 days after such occurrence (unless the ARCHITECT allows an additional period of time to ascertain more accurate data in support of the claim) and shall be accompanied by the CONTRACTOR's written statement that the amount claimed covers all known amounts (direct, indirect, and consequential) to which the CONTRACTOR is entitled as a result of said occurrence or event. All claims for adjustment in the Contract Price shall be determined by the ARCHITECT in accordance with Paragraph 9.8A if the OWNER and the CONTRACTOR cannot otherwise agree on the amount involved. No claim for an adjustment in the Contract Price will be valid if not submitted in accordance with this Paragraph 11.1B.

- C. The value of any WORK covered by a Change Order or of any claim for an increase or decrease in the Contract Price shall be determined in one of the following ways:
1. Where the WORK involved is covered by unit prices contained in the Contract Documents, by application of unit prices to the quantities of the items involved.
 2. By mutual acceptance of a lump sum, which may include an allowance for overhead and profit not necessarily in accordance with Paragraph 11.4.
 3. On the basis of the "Cost of WORK" (determined as provided in Paragraphs 11.3) plus a CONTRACTOR's fee for overhead and profit (determined as provided in Paragraph 11.4).

11.2 COSTS RELATING TO WEATHER. The CONTRACTOR shall have no claims against the OWNER for damages for any injury to WORK, materials, or equipment, resulting from the action of the elements. If, however, in the opinion of the ARCHITECT, the CONTRACTOR has made all reasonable efforts to protect the materials, equipment and WORK, the CONTRACTOR may be granted a reasonable extension of Contract Time to make proper repairs, renewals, and replacements of the WORK, materials, or equipment.

11.3 COST OF WORK (BASED ON TIME AND MATERIALS)

- A. General. The term "Cost of WORK" means the sum of all costs necessarily incurred and paid by the CONTRACTOR for labor, materials, and equipment in the proper performance of extra WORK. Except as otherwise may be agreed to in writing by the OWNER, such costs shall be in amounts no higher than those prevailing in the locality of the Project; shall include only the following items, and shall not include any of the costs itemized in Paragraph 11.5 EXCLUDED COSTS.
- B. Labor. The costs of labor will be the actual cost for wages prevailing for each craft or type of workers performing the extra WORK at the time the extra WORK is done, plus employer payments of payroll taxes, worker's compensation insurance, liability insurance, health and welfare, pension, vacation, apprenticeship funds, and other direct costs resulting from Federal, State or local laws, as well as assessments or benefits required by lawful collective bargaining agreements. Labor costs for equipment operators and helpers shall be paid only when such costs are not included in the invoice for equipment rental. The labor costs for forepersons shall be proportioned to all of their assigned WORK and only that applicable to extra WORK shall be paid. Non-direct labor costs including superintendence shall be considered part of the mark-up set out in paragraph 11.4.
- C. Materials. The cost of materials reported shall be at invoice or lowest current price at which materials are locally available and delivered to the job in the quantities involved, plus the cost of freight, delivery and storage, subject to the following:

SECTION 00700 - GENERAL CONDITIONS

1. Trade discounts available to the purchaser shall be credited to the OWNER notwithstanding the fact that such discounts may not have been taken by the CONTRACTOR.
 2. For materials secured by other than a direct purchase and direct billing to the purchaser, the cost shall be deemed to be the price paid to the actual supplier as determined by the ARCHITECT. Mark-up except for actual costs incurred in the handling of such materials will not be allowed.
 3. Payment for materials from sources owned wholly or in part by the purchaser shall not exceed the price paid by the purchaser for similar materials from said sources on extra WORK items or the current wholesale price for such materials delivered to the WORK site, whichever price is lower.
 4. If in the opinion of the ARCHITECT the cost of material is excessive, or the CONTRACTOR does not furnish satisfactory evidence of the cost of such material, then the cost shall be deemed to be the lowest current wholesale price for the quantity concerned delivered to the WORK site less trade discount. The OWNER reserves the right to furnish materials for the extra WORK and no claim shall be allowed by the CONTRACTOR for costs and profit on such materials.
- D. Equipment. The CONTRACTOR will be paid for the use of equipment at the rental rate listed for such equipment specified in the Supplementary General Conditions. Such rental rate will be used to compute payments for equipment whether the equipment is under the CONTRACTOR's control through direct ownership, leasing, renting, or another method of acquisition. The rental rate to be applied for use of each item of equipment shall be the rate resulting in the least total cost to the OWNER for the total period of use. If it is deemed necessary by the CONTRACTOR to use equipment not listed in the publication specified in the Supplementary General Conditions, an equitable rental rate for the equipment will be established by the ARCHITECT. The CONTRACTOR may furnish cost data which might assist the ARCHITECT in the establishment of the rental rate.
1. All equipment shall, in the opinion of the ARCHITECT, be in good working condition and suitable for the purpose for which the equipment is to be used.
 2. Before construction equipment is used on the extra WORK, the CONTRACTOR shall plainly stencil or stamp an identifying number thereon at a conspicuous location, and shall furnish to the ARCHITECT, in duplicate, a description of the equipment and its identifying number.
 3. Unless otherwise specified, manufacturer's ratings and manufacturer approved modifications shall be used to classify equipment for the determination of applicable rental rates. Equipment which has no direct power unit shall be powered by a unit of at least the minimum rating recommended by the manufacturer.
 4. Individual pieces of equipment or tools having a replacement value of \$200 or less, whether or not consumed by use, shall be considered to be small tools and no payment will be made therefor.
 5. Rental time will not be allowed while equipment is inoperative due to breakdowns.
 6. Equipment. Unless otherwise agreed to in writing, the CONTRACTOR will be paid for the use of equipment at the rental rate listed for such equipment specified in the current edition of the following reference publication: "Rental Rate Blue Book" available on-line at <http://www.equipmentwatch.com/rbbb.htm> or contact Equipment Watch at (800) 669-3282.
- E. Equipment on the WORK Site. The rental time to be paid for equipment on the WORK site shall be the time the equipment is in productive operation on the extra WORK being performed and, in addition, shall include the time required to move the equipment to the location of the extra WORK and return it to the original location or to another location requiring no more time than that required to return it to its original location; except, that moving time will not be paid if the equipment is used on other than the extra WORK, even though located at the site of the extra WORK. Loading and

SECTION 00700 - GENERAL CONDITIONS

transporting costs will be allowed, in lieu of moving time, when the equipment is moved by means other than its own power, except that no payment will be made for loading and transporting costs when the equipment is used at the site of the extra WORK on other than the extra WORK. The following shall be used in computing the rental time of equipment on the WORK site.

1. When hourly rates are listed, any part of an hour less than 30 minutes of operation shall be considered to be 1/2-hour of operation, and any part of an hour in excess of 30 minutes will be considered one hour of operation.
 2. When daily rates are listed, any part of a day less than 4 hours operation shall be considered to be 1/2-day of operation. When owner-operated equipment is used to perform extra WORK to be paid for on a time and materials basis, the CONTRACTOR will be paid for the equipment and operator, as set forth in Paragraphs (3), (4), and (5), following.
 3. Payment for the equipment will be made in accordance with the provisions in Paragraph 11.3D, herein.
 4. Payment for the cost of labor and subsistence or travel allowance will be made at the rates paid by the CONTRACTOR to other workers operating similar equipment already on the WORK site, or in the absence of such labor, established by collective bargaining agreements for the type of worker and location of the extra WORK, whether or not the operator is actually covered by such an agreement. A labor surcharge will be added to the cost of labor described herein in accordance with the provisions of Paragraph 11.3B, herein, which surcharge shall constitute full compensation for payments imposed by state and federal laws and all other payments made to or on behalf of workers other than actual wages.
 5. To the direct cost of equipment rental and labor, computed as provided herein, will be added the allowances for equipment rental and labor as provided in Paragraph 11.4, herein.
- F. Specialty WORK. Specialty WORK is defined as that WORK characterized by extraordinary complexity, sophistication, or innovation or a combination of the foregoing attributes which are unique to the construction industry. The following shall apply in making estimates for payment for specialty WORK:
1. Any bid item of WORK to be classified as Specialty WORK shall be listed as such in the Supplementary General Conditions. Specialty WORK shall be performed by an entity especially skilled in the work to be performed. After validation of invoices and determination of market values by the ARCHITECT, invoices for Specialty WORK based upon the current fair market value thereof may be accepted without complete itemization of labor, material, and equipment rental costs.
 2. When the CONTRACTOR is required to perform WORK necessitating special fabrication or machining process in a fabrication or a machine shop facility away from the job site, the charges for that portion of the WORK performed at the off-site facility may, by agreement, be accepted as Specialty WORK and accordingly, the invoices for the WORK may be accepted without detailed itemization.
 3. All invoices for specialty WORK will be adjusted by deducting all trade discounts offered or available, whether the discounts were taken or not. In lieu of the allowances for overhead and profit specified in Paragraph 11.4, herein, an allowance of 5 percent will be added to invoices for specialty WORK.
- G. Sureties. All WORK performed hereunder shall be subject to all of the provisions of the Contract Documents and the CONTRACTOR's sureties shall be bound with reference thereto as under the

SECTION 00700 - GENERAL CONDITIONS

original Agreement. Copies of all amendments to surety Bonds or supplemental surety Bonds shall be submitted to the OWNER for review prior to the performance of any WORK hereunder.

11.4 CONTRACTOR'S FEE

- A. Extra WORK ordered on the basis of time and materials will be paid for at the actual necessary cost as determined by the ARCHITECT, plus allowances for overhead and profit. The allowance for overhead and profit shall include full compensation for superintendence, Bond and insurance premiums, taxes, field office expense, extended overhead, home office overhead, and all other items of expense or cost not included in the cost of labor, materials, or equipment provided for under Paragraph 11.3. The allowance for overhead and profit will be made in accordance with the following schedule:

Actual Overhead and Profit Allowance

Labor	15 percent
Materials.....	10 percent
Equipment.....	10 percent

To the sum of the costs and mark-ups provided for in this Article, one (1) percent shall be added as compensation for Bonds.

- B. It is understood that labor, materials, and equipment may be furnished by the CONTRACTOR or by the Subcontractor on behalf of the CONTRACTOR. When all or any part of the extra WORK is performed by a Subcontractor, the allowance specified herein shall be applied to the labor, materials, and equipment costs of the Subcontractor, to which the CONTRACTOR may add five (5) percent of the Subcontractor's total cost for the extra WORK. Regardless of the number of hierarchical tiers of Subcontractors, the five (5) percent increase above the Subcontractor's total cost which includes the allowances for overhead and profit specified herein may be applied one time only.

11.5 EXCLUDED COSTS.

- A. The term "Cost of the WORK" shall not include any of the following:
 1. Payroll costs and other compensation of CONTRACTOR's officers, executives, principals (of partnership and sole proprietorships), general managers, architects, estimators, attorneys' auditors, accountants, purchasing and contracting agents, expenditures, timekeepers, clerks and other personnel employed by CONTRACTOR whether at the site or in CONTRACTOR's principal or a branch office for general administration of the WORK, or not specifically covered by paragraph 11.3, all of which are to be considered administrative costs covered by the CONTRACTOR's fee.
 2. Expenses of CONTRACTOR's principal and branch offices other than CONTRACTOR's office at the site.
 3. Any part of CONTRACTOR's capital expenses, including interest on CONTRACTOR's capital employed for the WORK and charges against CONTRACTOR for delinquent payments.
 4. Cost of premiums for all Bonds and for all insurance whether or not CONTRACTOR is required by the Contract Documents to purchase and maintain the same (except for the cost of premiums covered by paragraph 11.4 above).
 5. Costs due to the negligence of CONTRACTOR, any Subcontractor, or anyone directly or indirectly employed by any of them or for whose acts any of them may be liable, including but

SECTION 00700 - GENERAL CONDITIONS

not limited to, the correction of Defective WORK, disposal of materials or equipment wrongly supplied and making good any damage to property.

6. Other overhead or general expense costs of any kind and the cost of any item not specifically and expressly included in paragraph 11.4.

ARTICLE 12 CHANGE OF CONTRACT TIME

12.1 GENERAL

- A. The Contract Time may only be changed by a Change Order. Any claim for an extension of the Contract Time (or Milestones) shall be based on written notice delivered by the CONTRACTOR to the ARCHITECT promptly (but in no event later than 30 days) after the occurrence of the event giving rise to the claim and stating the general nature of the claim. Notice of the extent of the claim with supporting data shall be delivered within 60 days after such occurrence (unless the ARCHITECT allows an additional period of time to ascertain more accurate data in support of the claim) and shall be accompanied by the CONTRACTOR's written statement that the adjustment claimed is the entire adjustment to which the CONTRACTOR has reason to believe it is entitled as a result of the occurrence of said event. All claims for adjustment in the Contract Time shall be determined by the ARCHITECT in accordance with Paragraph 9.8 if the OWNER and the CONTRACTOR cannot otherwise agree. No claim for an adjustment in the Contract Time will be valid if not submitted in accordance with the requirements of this paragraph. An increase in Contract Time does not mean that the CONTRACTOR is due an increase in Contract Price. Only Compensable time extensions will result in an increase in Contract Price.
- B. All time limits stated in the Contract Documents are of the essence of the Agreement.
- C. Where CONTRACTOR is prevented from completing any part of the WORK within the Contract Times (or Milestones) due to delay beyond the control of CONTRACTOR, the Contract Times (or Milestones) will be extended in an amount equal to the time lost on the critical path of the Project due to such delay if a claim is made therefor as provided in paragraph 12.1. Delays beyond the control of CONTRACTOR shall include, but not be limited to, acts or neglect by OWNER, acts or neglect of utility owners or other contractors performing other work as contemplated by Article 7, fires, floods, epidemics, unprecedented weather conditions or acts of God. Delays attributable to and within the control of a Subcontractor or Supplier shall be deemed to be delays within the control of CONTRACTOR.
- D. Where CONTRACTOR is prevented from completing any part of the WORK within the Contract Times (or Milestones) due to delay beyond the control of both OWNER and CONTRACTOR, an extension of the Contract Times (or Milestones) in an amount equal to the time lost on the critical path of the Project due to such delay shall be CONTRACTOR's sole and exclusive remedy for such delay. In no event shall the OWNER be liable to CONTRACTOR, any Subcontractor, any Supplier, or any other person or organization, or to any surety for or employee or agent of any of them, for damages arising out of or resulting from (i) delays caused by or within the control of CONTRACTOR, or (ii) delays beyond the control of both parties including but not limited to fires, floods, epidemics abnormal weather conditions, acts of God or acts or neglect by utility owners or other contractors performing other work as contemplated by Article 7.

SECTION 00700 - GENERAL CONDITIONS

- 12.2 EXTENSIONS OF TIME FOR DELAY DUE TO WEATHER. Contract time may be extended by the ARCHITECT because of delays in completion of the WORK due to unusually severe weather, provided that the CONTRACTOR shall, within 10 days of the beginning of any such delay, notify the ARCHITECT in writing of the cause of delay and request an extension of contract time. The ARCHITECT will ascertain the facts and the extent of the delay and extend the time for completing the WORK when, in the ARCHITECT's judgment, the findings of fact justify such an extension. Unprecedented, abnormal, or unusually severe weather will be defined as an event, or events, with a greater than 50-year recurrence interval, as determined by the National Weather Service, or equivalent state or federal agency.

ARTICLE 13 WARRANTY AND GUARANTEE; TESTS AND INSPECTIONS; CORRECTION, REMOVAL, OR ACCEPTANCE OF DEFECTIVE WORK

- 13.1 WARRANTY AND GUARANTEE. The CONTRACTOR warrants and guarantees to the OWNER and the ARCHITECT that all WORK will be in accordance with the Contract Documents and will not be defective. Prompt notice of defects known to the OWNER or ARCHITECT shall be given to the CONTRACTOR. All Defective WORK, whether or not in place, may be rejected, corrected, or accepted as provided in this Article 13.
- 13.2 ACCESS TO WORK. The OWNER, ARCHITECT, Architect of Record, their consultants, sub-consultants, other representatives and personnel of OWNER, independent testing laboratories and governmental agencies with jurisdictional interests will have access to the WORK at reasonable times for their observation, inspecting and testing. CONTRACTOR shall provide them proper and safe conditions for such access and advise them of CONTRACTOR's site safety procedures and programs so that they may comply therewith as applicable.
- 13.3 INSPECTIONS AND TESTS
- A. The CONTRACTOR shall give the ARCHITECT timely notice of readiness of the WORK for all required inspections, tests, or approvals, and shall cooperate with inspection and testing personnel to facilitate required inspections or tests.
- B. If Laws or Regulations of any public body having jurisdiction other than the OWNER require any WORK to specifically be inspected, tested, or approved, the CONTRACTOR shall pay all costs in connection therewith. The CONTRACTOR shall also be responsible for and shall pay all costs in connection with any inspection or testing required in connection with the OWNER's or the ARCHITECT's acceptance of a Supplier of materials or equipment proposed as a substitution or (or-equal) to be incorporated in the WORK, or of materials or equipment submitted for review prior to the CONTRACTOR's purchase thereof for incorporation in the WORK. The cost of all inspections, tests, and approvals in addition to the above which are required by the Contract Documents shall be paid by the OWNER (unless otherwise specified).
- C. The ARCHITECT will make, or have made, such inspections and tests as the ARCHITECT deems necessary to see that the WORK is being accomplished in accordance with the requirements of the Contract Documents. Unless otherwise specified in the Supplementary General Conditions, the cost of such inspection and testing will be borne by the OWNER. In the event such inspections or tests reveal non-compliance with the requirements of the Contract Documents, the CONTRACTOR shall bear the cost of corrective measures deemed necessary by the ARCHITECT, as well as the cost of subsequent re-inspection and retesting. Neither observations by the ARCHITECT nor inspections, tests, or

SECTION 00700 - GENERAL CONDITIONS

approvals by others shall relieve the CONTRACTOR from the CONTRACTOR's obligation to perform the WORK in accordance with the Contract Documents.

- D. All inspections, tests, or approvals other than those required by Laws or Regulations of any public body having jurisdiction shall be performed by organizations acceptable to the ARCHITECT and the CONTRACTOR.
 - E. If any WORK (including the work of others anticipated under paragraph 7.1) that is to be inspected, tested, or approved is covered without written concurrence of the ARCHITECT, it must, if requested by the ARCHITECT, be uncovered for observation. Such uncovering shall be at the CONTRACTOR's expense unless the CONTRACTOR has given the ARCHITECT timely notice of the CONTRACTOR's intention to perform such test or to cover the same and the ARCHITECT has not acted with reasonable promptness in response to such notice.
 - F. If any WORK is covered contrary to the written request of the ARCHITECT, it must, if requested by the ARCHITECT, be uncovered for the ARCHITECT's observation and recovered at the CONTRACTOR's expense.
 - G. If the ARCHITECT considers it necessary or advisable that covered WORK be observed by the ARCHITECT or inspected or tested by others, the CONTRACTOR, at the ARCHITECT's request, shall uncover, expose, or otherwise make available for observation, inspection, or testing as the ARCHITECT may require, that portion of the WORK in question, furnishing all necessary labor, material, and equipment. If it is found that such WORK is defective, the CONTRACTOR shall bear all direct, indirect, and consequential costs and damages of such uncovering, exposure, observation, inspection, and testing and of satisfactory reconstruction, including but not limited to fees and charges of Architects of Record, attorneys, and other professionals. However, if such WORK is not found to be defective, the CONTRACTOR shall be allowed an increase in the Contract Price or an extension of the Contract Time, or both, directly attributable to such uncovering, exposure, observation, inspection, testing, and reconstruction; and, if the parties are unable to agree as to the amount or extent thereof, the CONTRACTOR may make a claim therefor as provided in Articles 11 and 12.
- 13.4 OWNER MAY STOP THE WORK. If the WORK is defective, or the CONTRACTOR fails to perform WORK in such a way that the completed WORK will conform to the Contract Documents, the OWNER may order the CONTRACTOR to stop the WORK, or any portion thereof, until the cause for such order has been eliminated; however, this right of the OWNER to stop the WORK shall not give rise to any duty on the part of the OWNER to exercise this right for the benefit of the CONTRACTOR or any other party.
- 13.5 CORRECTION OR REMOVAL OF DEFECTIVE WORK. If required by the ARCHITECT, the CONTRACTOR shall promptly, either correct all Defective WORK, whether or not fabricated, installed, or completed, or, if the WORK has been rejected by the ARCHITECT, remove it from the site and replace it with non-defective WORK. The CONTRACTOR shall bear all direct, indirect and consequential costs and damages of such correction or removal, including but not limited to fees and charges of Architects of Record, attorneys, and other professionals made necessary thereby.
- 13.6 ONE YEAR CORRECTION PERIOD
- A. If within one year after the date of Substantial Completion or such longer period of time as may be prescribed by Laws or Regulations or by the terms of any applicable special guarantee required by the

SECTION 00700 - GENERAL CONDITIONS

Contract Documents or by any specific provision of the Contract Documents, any WORK is found to be defective, the CONTRACTOR shall promptly, without cost to the OWNER and in accordance with OWNER's written notification, (i) correct such Defective WORK, or, if it has been rejected by the OWNER, remove it from the site and replace it with non-defective WORK, and (ii) satisfactorily correct or remove and replace any damage to other work of others resulting therefrom. If the CONTRACTOR does not promptly comply with such notification, or in an emergency where delay would cause serious risk of loss or damage, the OWNER may have the Defective WORK corrected or the rejected WORK removed and replaced, and all direct, indirect, and consequential costs and damages of such removal and replacement including but not limited to fees and charges of Architects of Record, attorneys and other professionals will be paid by the CONTRACTOR.

- B. Where Defective WORK (and damage to other WORK resulting therefrom) has been corrected, removed or replaced under this paragraph 13.6, the correction period hereunder with respect to such WORK will be extended for an additional period of one year after such correction or removal and replacement has been satisfactorily completed.

- 13.7 ACCEPTANCE OF DEFECTIVE WORK. If, instead of requiring correction or removal and replacement of Defective WORK, the OWNER prefers to accept the WORK, the OWNER may do so. The CONTRACTOR shall bear all direct, indirect, and consequential costs attributable to the OWNER's evaluation of and determination to accept such Defective WORK. If any such acceptance occurs prior to final payment, a Change Order will be issued incorporating the necessary revisions in the Contract Documents with respect to the WORK, and the OWNER shall be entitled to an appropriate decrease in the Contract Price.

ARTICLE 14 PAYMENTS TO CONTRACTOR AND COMPLETION

- 14.1 SCHEDULE OF VALUES (LUMP SUM PRICE BREAKDOWN). The Schedule of Values or lump sum price breakdown established as provided in the General Requirements shall serve as the basis for progress payments and will be incorporated into a form of Application for Payment acceptable to the ARCHITECT.

- 14.2 UNIT PRICE BID SCHEDULE. Progress payments on account of Unit Price WORK will be based on the number of units completed.

14.3 APPLICATION FOR PROGRESS PAYMENT

- A. Unless otherwise prescribed by law, on the 25th of each month, the CONTRACTOR shall submit to the ARCHITECT for review, an Application for Payment filled out and signed by the CONTRACTOR covering the WORK completed as of the date of the Application and accompanied by such supporting documentation as is required by the Contract Documents.
- B. The Application for Payment shall identify, as a sub-total, the amount of the CONTRACTOR's Total Earnings to Date, plus the Value of Materials Stored at the Site which have not yet been incorporated in the WORK, and less a deductive adjustment for materials installed which were not previously incorporated in the WORK, but for which payment was allowed under the provisions for payment for Materials Stored at the Site, but not yet incorporated in the WORK.
- C. The Net Payment Due the CONTRACTOR shall be the above-mentioned subtotal from which shall be deducted the total amount of all previous payments made to the CONTRACTOR. Progress payments

SECTION 00700 - GENERAL CONDITIONS

will be paid in full in accordance with Article 14 of the General Conditions until 90% of the contract amount has been paid. The remaining 10% of the contract amount shall be retained until:

1. final inspection has been made;
 2. completion of the project;
 3. acceptance of the project by the OWNER and;
 4. the OWNER has received notification from the Alaska Department of Labor that the CONTRACTOR has no outstanding wage/hour violations.
- D. The Value of Materials Stored at the Site shall be an amount equal to the specified percent of the value of such materials as set forth in the Supplementary General Conditions. Said amount shall be based upon the value of all acceptable materials and equipment not incorporated in the WORK but delivered and suitably stored at the Project site or at another location agreed to in writing; provided, each such individual item has a value of more than \$5000 and will become a permanent part of the WORK. The Application for Payment shall also be accompanied by a bill of sale, invoice, or other documentation warranting that the CONTRACTOR has received the materials and equipment free and clear of all liens, charges, security interests, and encumbrances (which are hereinafter in these General Conditions referred to as "Liens") and evidence that the materials and equipment are covered by appropriate property insurance and other arrangements to protect the OWNER's interest therein, all of which will be satisfactory to the OWNER.
- 14.4 CONTRACTOR'S WARRANTY OF TITLE. The CONTRACTOR warrants and guarantees that title to all WORK, materials, and equipment covered by an Application for Payment, whether incorporated in the WORK or not, will pass to the OWNER no later than the time of payment free and clear of all liens.
- 14.5 REVIEW OF APPLICATIONS FOR PROGRESS PAYMENT
- A. The ARCHITECT will, within seven (7) days after receipt of each Application for Payment, either indicate in writing a recommendation of payment and present the Application to the OWNER, or return the Application to the CONTRACTOR indicating in writing the ARCHITECT's reasons for refusing to recommend payment. In the later case, the CONTRACTOR may make the necessary corrections and resubmit the Application. If the ARCHITECT still disagrees with a portion of the Application, it will submit the Application recommending the undisputed portion of the Application to the OWNER for review and provide reasons for recommending non-payment of the disputed amount. Thirty days after presentation of the Application for Payment with the ARCHITECT's recommendation, the amount recommended will (subject to the provisions of Paragraph 14.5B) become due and when due will be paid by the OWNER to the CONTRACTOR.
 - B. The OWNER may refuse to make payment of the full amount recommended by the ARCHITECT because claims have been made against the OWNER on account of the CONTRACTOR's performance of the WORK or Liens have been filed in connection with the WORK or there are other items entitling the OWNER to a credit against the amount recommended, but the OWNER must give the CONTRACTOR written notice within seven (7) days (with a copy to the ARCHITECT) stating the reasons for such action.

SECTION 00700 - GENERAL CONDITIONS

14.6 PARTIAL UTILIZATION

- A. The OWNER shall have the right to utilize or place into service any item of equipment or other usable portion of the WORK prior to completion of the WORK. Whenever the OWNER plans to exercise said right, the CONTRACTOR will be notified in writing by the OWNER, identifying the specific portion or portions of the WORK to be so utilized or otherwise placed into service.
- B. It shall be understood by the CONTRACTOR that until such written notification is issued, all responsibility for care and maintenance of all of the WORK shall be borne by the CONTRACTOR. Upon issuance of said written notice of partial utilization, the OWNER will accept responsibility for the protection and maintenance of all such items or portions of the WORK described in the written notice.
- C. The CONTRACTOR shall retain full responsibility for satisfactory completion of the WORK, regardless of whether a portion thereof has been partially utilized by the OWNER and the CONTRACTOR's one year correction period shall commence only after the date of Substantial Completion for the WORK.

14.7 SUBSTANTIAL COMPLETION. When the CONTRACTOR considers the WORK ready for its intended use the CONTRACTOR shall notify the OWNER and the ARCHITECT in writing that the WORK is substantially complete. The CONTRACTOR will attach to this request a list of all WORK items that remain to be completed and a request that the ARCHITECT prepare a Notice of Completion. Within a reasonable time thereafter, the OWNER, the CONTRACTOR, and the ARCHITECT shall make an inspection of the WORK to determine the status of completion. If the ARCHITECT does not consider the WORK substantially complete, or the list of remaining WORK items to be comprehensive, the ARCHITECT will notify the CONTRACTOR in writing giving the reasons thereof. If the ARCHITECT considers the WORK substantially complete, the ARCHITECT will prepare and deliver to the OWNER, for its execution and recording, the Notice of Completion signed by the ARCHITECT and CONTRACTOR, which shall fix the date of Substantial Completion.

14.8 FINAL APPLICATION FOR PAYMENT. After the CONTRACTOR has completed all of the remaining WORK items referred to in Paragraph 14.7 and delivered all maintenance and operating instructions, schedules, guarantees, Bonds, certificates of inspection, record as-built documents (as provided in the General Requirements) and other documents, all as required by the Contract Documents, and after the ARCHITECT has indicated that the WORK is acceptable, the CONTRACTOR may make application for final payment following the procedure for progress payments. The final Application for Payment shall be accompanied by all documentation called for in the Contract Documents, together with complete and legally effective releases or waivers (satisfactory to the OWNER) of all liens arising out of or filed in connection with the WORK.

14.9 FINAL PAYMENT AND ACCEPTANCE

- A. If, on the basis of the ARCHITECT's observation of the WORK during construction and final inspection, and the ARCHITECT's review of the final Application for Payment and accompanying documentation, all as required by the Contract Documents, the ARCHITECT is satisfied that the WORK has been completed and the CONTRACTOR's other obligations under the Contract Documents have been fulfilled, the ARCHITECT will, within 14 days after receipt of the final Application for Payment, indicate in writing the ARCHITECT's recommendation of payment and present the Application to the OWNER for payment.

SECTION 00700 - GENERAL CONDITIONS

- B. After acceptance of the WORK by the OWNER's governing body, the OWNER will make final payment to the CONTRACTOR of the amount remaining after deducting all prior payments and all amounts to be kept or retained under the provisions of the Contract Documents, including the following items:
1. Liquidated damages, as applicable.
 2. Two times the value of outstanding items of correction WORK or punch list items yet uncompleted or uncorrected, as applicable. All such WORK shall be completed or corrected to the satisfaction of the OWNER within the time stated on the Notice of Completion, otherwise the CONTRACTOR does hereby waive any and all claims to all monies withheld by the OWNER to cover the value of all such uncompleted or uncorrected items.

14.10 RELEASE OF RETAINAGE AND OTHER DEDUCTIONS

- A. After executing the necessary documents to initiate the lien period, and not more than 45 days thereafter (based on a 30-day lien filing period and 15-day processing time), the OWNER will release to the CONTRACTOR the retainage funds withheld pursuant to the Agreement, less any deductions to cover pending claims against the OWNER pursuant to Paragraph 14.5B.
- B. After filing of the necessary documents to initiate the lien period, the CONTRACTOR shall have 30 days to complete any outstanding items of correction WORK remaining to be completed or corrected as listed on a final punch list made a part of the Notice of Completion. Upon expiration of the 45 days, referred to in Paragraph 14.10A, the amounts withheld pursuant to the provisions of Paragraph 14.9B herein, for all remaining WORK items will be returned to the CONTRACTOR; provided, that said WORK has been completed or corrected to the satisfaction of the OWNER within said 30 days. Otherwise, the CONTRACTOR does hereby waive any and all claims for all monies withheld by the OWNER under the contract to cover 2 times the value of such remaining uncompleted or uncorrected items.

14.11 CONTRACTOR'S CONTINUING OBLIGATION. The CONTRACTOR's obligation to perform and complete the WORK in accordance with the Contract Documents shall be absolute. Neither recommendation of any progress or final payment by the ARCHITECT, nor the issuance of a Notice of Completion, nor any payment by the OWNER to the CONTRACTOR under the Contract Documents, nor any use or occupancy of the WORK or any part thereof by the OWNER, nor any act of acceptance by the OWNER nor any failure to do so, nor any review of a Shop Drawing or sample submittal, will constitute an acceptance of WORK not in accordance with the Contract Documents or a release of the CONTRACTOR's obligation to perform the WORK in accordance with the Contract Documents.

14.12 FINAL PAYMENT TERMINATES LIABILITY OF OWNER. Final payment is defined as the last progress payment made to the CONTRACTOR for earned funds, less monies withheld as applicable, pursuant to Paragraph 14.10A. The acceptance by the CONTRACTOR of the final payment referred to in Paragraph 14.9 herein, shall be a release of the OWNER and its agents from all claims of liability to the CONTRACTOR for anything done or furnished for, or relating to, the WORK or for any act of neglect of the OWNER or of any person relating to or affecting the WORK, except demands against the OWNER for the remainder, if any, of the amounts kept or retained under the provisions of Paragraph 14.9 herein; and excepting pending, unresolved claims filed prior to the date of the Notice of Completion.

SECTION 00700 - GENERAL CONDITIONS

ARTICLE 15 SUSPENSION OF WORK AND TERMINATION

- 15.1 SUSPENSION OF WORK BY OWNER. The OWNER, acting through the ARCHITECT, may, at any time and without cause, suspend the WORK or any portion thereof for a period of not more than 90 days by notice in writing to the CONTRACTOR. The CONTRACTOR shall resume the WORK on receipt from the ARCHITECT of a notice of resumption of WORK. The CONTRACTOR shall be allowed an increase in the Contract Price or an extension of the Contract Time, or both, directly attributable to any suspension if the CONTRACTOR makes an approved claim therefor as provided in Articles 11 and 12.
- 15.2 TERMINATION OF AGREEMENT BY OWNER (CONTRACTOR DEFAULT)
- A. In the event of default by the CONTRACTOR, the OWNER may give 10 days written notice to the CONTRACTOR of OWNER's intent to terminate the Agreement and provide the CONTRACTOR an opportunity to remedy the conditions constituting the default. It shall be considered a default by the CONTRACTOR whenever CONTRACTOR shall: (1) declare bankruptcy, become insolvent, or assign its assets for the benefit of its creditors; (2) fail to provide materials or quality of WORK meeting the requirements of the Contract Documents; (3) disregard or violate provisions of the Contract Documents or ARCHITECT's instructions; (4) fail to prosecute the WORK according to the approved progress schedule; or, (5) fail to provide a qualified superintendent, competent workers, or materials or equipment meeting the requirements of the Contract Documents. If the CONTRACTOR fails to remedy the conditions constituting default within the time allowed, the OWNER may then issue the Notice of Termination.
- B. In the event the Agreement is terminated in accordance with Paragraph 15.2A, herein, the OWNER may take possession of the WORK and may complete the WORK by whatever method or means the OWNER may select. The cost of completing the WORK shall be deducted from the balance which would have been due the CONTRACTOR had the Agreement not been terminated and the WORK completed in accordance with the Contract Documents. If such cost exceeds the balance which would have been due, the CONTRACTOR shall pay the excess amount to the OWNER. If such cost is less than the balance which would have been due, the CONTRACTOR shall not have claim to the difference.
- 15.3 TERMINATION OF AGREEMENT BY OWNER (FOR CONVENIENCE). The OWNER may terminate the Agreement at any time if it is found that reasons beyond the control of either the OWNER or CONTRACTOR make it impossible or against the OWNER's interests to complete the WORK. In such a case, the CONTRACTOR shall have no claims against the OWNER except: (1) for the value of WORK performed up to the date the Agreement is terminated; and, (2) for the cost of materials and equipment on hand, in transit, or on definite commitment, as of the date the Agreement is terminated, which would be needed in the WORK and which meet the requirements of the Contract Documents. The value of WORK performed and the cost of materials and equipment delivered to the site, as mentioned above, shall be determined by the ARCHITECT in accordance with the procedure prescribed for the making of the final Application for Payment and payment under Paragraphs 14.8 and 14.9.
- 15.4 TERMINATION OF AGREEMENT BY CONTRACTOR. The CONTRACTOR may terminate the Agreement upon 10 days written notice to the OWNER, whenever: 1) the WORK has been suspended under the provisions of Paragraph 15.1, herein, for more than 90 consecutive days through no fault or

SECTION 00700 - GENERAL CONDITIONS

negligence of the CONTRACTOR, and notice to resume WORK or to terminate the Agreement has not been received from the OWNER within this time period; or, 2) the OWNER should fail to pay the CONTRACTOR any monies due to the CONTRACTOR in accordance with the terms of the Contract Documents and within 60 days after presentation to the OWNER by the CONTRACTOR of a request therefor, unless within said 10-day period the OWNER shall have remedied the condition upon which the payment delay was based. In the event of such termination, the CONTRACTOR shall have no claims against the OWNER except for those claims specifically enumerated in Paragraph 15.3, herein, and as determined in accordance with the requirements of said paragraph.

ARTICLE 16 MISCELLANEOUS

- 16.1 GIVING NOTICE. Whenever any provision of the Contract Documents requires the giving of written notice, it will be deemed to have been validly given if delivered in person to the individual or to a member of the firm or to an officer of the corporation for whom it is intended, or if delivered at or sent by registered or certified mail, postage prepaid, to the last business address known to the giver of the notice.
- 16.2 RIGHTS IN AND USE OF MATERIALS FOUND ON THE WORK
- A. The CONTRACTOR may use on the Project, with ARCHITECT's approval, such stone, gravel, sand, or other material determined suitable by the ARCHITECT, as may be found in the excavation. The CONTRACTOR will be paid for the excavation of such material at the corresponding contract unit price. No additional payment will be made for utilizing the material from excavation as borrow, or select borrow.
 - B. The CONTRACTOR shall replace, at its own expense, with other acceptable material, all of that portion of the excavated material so removed and used which was needed for use on the Project. No charge for the materials so used will be made against the CONTRACTOR except that the CONTRACTOR shall be responsible for payment of any royalties required.
 - C. The CONTRACTOR shall not excavate or remove any material from within the Project location which is not within the grading limits, as indicated by the slope and grade lines, without written authorization from the ARCHITECT.
 - D. In the event the CONTRACTOR has processed materials from OWNER-furnished sources in excess of the quantities required for performance of this contract, including any waste material produced as a by-product, the CBJ may retain possession of such materials without obligation to reimburse the CONTRACTOR for the cost of their production. When such materials are in a stockpile, the ARCHITECT may require: that it remain in stockpile; the CONTRACTOR level such stockpile(s); or that the CONTRACTOR remove such materials and restore the premises to a satisfactory condition at the CONTRACTOR's expense. This provision shall not preclude the CBJ from arranging with the CONTRACTOR to produce material over and above the contract needs, payment for which shall be by written agreement between the CBJ and the CONTRACTOR.
 - E. Unless otherwise provided, the material from any existing old structure may be used temporarily by the CONTRACTOR in the erection of the new structure. Such material shall not be cut or otherwise damaged except with the approval of the ARCHITECT.

SECTION 00700 - GENERAL CONDITIONS

- 16.3 **RIGHT TO AUDIT.** If the CONTRACTOR submits a claim to the OWNER for additional compensation, the OWNER shall have the right, as a condition to considering the claim, and as a basis for evaluation of the claim, and until the claim has been settled, to audit the CONTRACTOR's books to the extent they are relevant. This right shall include the right to examine books, records, documents, and other evidence and accounting procedures and practices, sufficient to discover and verify all direct and indirect costs of whatever nature claimed to have been incurred or anticipated to be incurred and for which the claim has been submitted. The right to audit shall include the right to inspect the CONTRACTOR's plants, or such parts thereof, as may be or have been engaged in the performance of the WORK. The CONTRACTOR further agrees that the right to audit encompasses all subcontracts and is binding upon Subcontractors. The rights to examine and inspect herein provided for shall be exercisable through such representatives as the OWNER deems desirable during the CONTRACTOR's normal business hours at the office of the CONTRACTOR. The CONTRACTOR shall make available to the OWNER for auditing, all relevant accounting records and documents, and other financial data, and upon request, shall submit true copies of requested records to the OWNER.
- 16.4 **ARCHAEOLOGICAL OR HISTORICAL DISCOVERIES.** When the CONTRACTOR's operation encounters prehistoric artifacts, burials, remains of dwelling sites, paleontological remains, such as shell heaps, land or sea mammal bones or tusks, or other items of historical significance, the CONTRACTOR shall cease operations immediately and notify the ARCHITECT. No artifacts or specimens shall be further disturbed or removed from the ground and no further operations shall be performed at the site until so directed. Should the ARCHITECT order suspension of the CONTRACTOR's operations in order to protect an archaeological or historical finding, or order the CONTRACTOR to perform extra WORK, such order(s) shall be covered by an appropriate contract change document.
- 16.5 **CONSTRUCTION OVER OR ADJACENT TO NAVIGABLE WATERS.** All WORK over, on, or adjacent to navigable waters shall be so conducted that free navigation of the waterways will not be interfered with and the existing navigable depths will not be impaired, except as allowed by permit issued by the U.S. Coast Guard and/or the U.S. Army Corps of Engineers, as applicable.
- 16.6 **GRATUITY AND CONFLICT OF INTEREST.** The CONTRACTOR agrees to not extend any loan, gratuity or gift of money of any form whatsoever to any employee or elected official of the OWNER, nor will the CONTRACTOR rent or purchase any equipment or materials from any employee or elected official of the OWNER, or to the best of the CONTRACTOR's knowledge, from any agent of any employee or elected official of the OWNER. Before final payment, the CONTRACTOR shall execute and furnish the OWNER an affidavit certifying that the CONTRACTOR has complied with the above provisions of the contract.
- 16.7 **SUITS OF LAW CONCERNING THE WORK**
- A. Should a suit of law be entered into, either by the CONTRACTOR (or the CONTRACTOR's surety) against the OWNER, or by the OWNER against the CONTRACTOR (or the CONTRACTOR's surety), the suit of law shall be tried in the First Judicial District of Alaska.
 - B. If one of the questions at issue is the satisfactory performance of the WORK by the CONTRACTOR and should the appropriate court of law judge the WORK of the CONTRACTOR to be unsatisfactory, then the CONTRACTOR (or the CONTRACTOR's surety) shall reimburse the OWNER for all legal and all other expenses (as may be allowed and set by the court) incurred by the OWNER because of

SECTION 00700 - GENERAL CONDITIONS

the suit of the law and, further, it is agreed that the OWNER may deduct such expense from any sum or sums then, or any that become due the CONTRACTOR under the contract.

16.8 CERTIFIED PAYROLLS

- A. All CONTRACTORs or Subcontractor who perform work on a public construction contract for the OWNER shall file a Certified Payroll with the Alaska Department of Labor every two weeks. Before the second Friday, each CONTRACTOR and Subcontractor must file Certified Payrolls with Statements of Compliance for the previous two weeks. (Section 14-2-4 ACLA 1949; am Section 4 ch 142 SLA 1972).
- B. In lieu of submitting the State payroll form, the CONTRACTOR's standard payroll form may be submitted, provided it contains the information required by AS 36.05.040 and a statement that the CONTRACTOR is complying with AS 36.10.010.
- C. Any CONTRACTOR or Subcontractor, who performs work on public construction in the State, as defined by AS 36.95.010(3), shall pay not less than the current prevailing rate of wages as issued by the Alaska Department of Labor before the end of the pay period. (AS 36.05.010).

16.9 PREVAILING WAGE RATES

- A. Wage rates for Laborers and Mechanics on Public Contracts, AS 36.05.070. The CONTRACTOR, or Subcontractors, shall pay all employees unconditionally and not less than once a week. Wages may not be less than those stated in Paragraph 16.8C, regardless of the contractual relationship between the CONTRACTOR or Subcontractors and laborers, mechanics, or field surveyors. The scale of wages to be paid shall be posted by the CONTRACTOR in a prominent, easily accessible place at the site of the WORK.
- B. Failure to Pay Agreed Wages, AS 36.05.080. If it is found that a laborer, mechanic, or field surveyor employed by the CONTRACTOR or Subcontractor has been, or is being, paid a rate or wages less than the established rate, the OWNER may, by written notice, terminate the CONTRACTOR or Subcontractors right to proceed with the WORK. The OWNER may prosecute the WORK to completion by contract or otherwise, and the CONTRACTOR and sureties will be held liable to the OWNER for excess costs for completing the WORK. (Section 2 ch 52 SLA 1959).
- C. Listing CONTRACTORS Who Violate contracts, AS 36.05.090. In addition, a list giving the names of persons who have disregarded the rights of their employees shall be distributed to all departments of State government and all political subdivisions. No person appearing on this list, and no firm, corporation, partnership or association in which the person has an interest, may WORK as a CONTRACTOR or Subcontractor on a public construction contract for the State, or a political subdivision of the state, until three years after the date of publication of the list. (Section 3 ch 52 SLA 1959; am Section 9 ch 142 SLA).

- 16.10 EMPLOYMENT REFERENCE. Workers employed in the execution of the contract by the CONTRACTOR or by any Subcontractor under this contract shall not be required or permitted to labor more than 8 hours a day or 40 hours per week in violation of the provisions of the Alaska Wage and Hour Act, Section 23.10.060.

SECTION 00700 - GENERAL CONDITIONS

16.11 COST REDUCTION INCENTIVE

- A. At any time within 45 days after the date of the Notice of Award, the CONTRACTOR may submit to the ARCHITECT in writing, proposals for modifying the plans, specifications, or other requirements of this contract for the sole purpose of reducing the total cost of construction. The cost reduction proposal shall not impair in any manner the essential functions or characteristics of the project, including but not limited to, service life, economy of operation, ease of maintenance, desired appearance or design and safety standards.
- B. The cost reduction proposal shall contain the following information:
 - 1. Description of both the existing contract requirements for performing the WORK and the proposed changes.
 - 2. An itemization of the contract requirements that must be changed if the proposal is adopted.
 - 3. A detailed estimate of the time required and the cost of performing the WORK under both the existing contract and the proposed change.
 - 4. A statement of the date by which the CONTRACTOR must receive the decision from the OWNER on the cost reduction proposal.
 - 5. The contract items of WORK effected by the proposed changes including any quantity variations.
 - 6. A description and estimate of costs the OWNER may incur in implementing the proposed changes, such as test and evaluation and operating and support costs.
 - 7. A prediction of any effects the proposed change would have on future operations and maintenance costs to the OWNER.
- C. The provisions of this section shall not be construed to require the OWNER to consider any cost reduction proposal which may be submitted; nor will the OWNER be liable to the CONTRACTOR for failure to accept or act upon any cost reduction proposal submitted, or for delays to the WORK attributable to the consideration or implementation of any such proposal.
- D. If a cost reduction proposal is similar to a change in the plans or Specifications for the Project under consideration by the OWNER at the time the proposal is submitted, the OWNER will not accept such proposal and reserves the right to make such changes without compensation to the CONTRACTOR under the provisions of this section.
- E. The CONTRACTOR shall continue to perform the WORK in accordance with the requirements of the contract until an executed Change Order incorporating the cost reduction proposal has been issued. If any executed Change Order has not been issued by the date upon which the CONTRACTOR's cost reduction proposal specifies that a decision should be made by the OWNER, in writing, the cost reduction proposal shall be considered rejected.
- F. The OWNER, shall be the sole judge of the acceptability of a cost reduction proposal and of the estimated net savings in Contract Time and construction costs resulting from the adoption of all or any part of such proposal. Should the CONTRACTOR disagree with OWNER's decision on the cost reduction proposal, there is no further consideration. The OWNER reserves the right to make final determination.
- G. If the CONTRACTOR's cost reduction proposal is accepted in whole or in part, such acceptance will be made by a Contract Change Order, which specifically states that the change is executed pursuant to

SECTION 00700 - GENERAL CONDITIONS

this cost reduction proposal section. Such Change Order shall incorporate the changes in the plans and Specifications which are necessary to permit the cost reduction proposal or such part of it as has been accepted to be put into effect and shall include any conditions upon which the OWNER's approval is based, if such approval is conditional. The Change Order shall also describe the estimated net savings in the cost of performing the WORK attributable to the cost reduction proposal, and shall further provide that the contract cost be adjusted by crediting the OWNER with the estimated net savings amount.

- H. Acceptance of the cost reduction proposal and performance of the WORK does not extend the time of completion of the contract, unless specifically provided in the Change Order authorizing the use of the submitted proposal. Should the adoption of the cost reduction proposal result in a Contract Time savings, the total Contract Time shall be reduced by an amount equal to the time savings realized.
- I. The amount specified to the CONTRACTOR in the Change Order accepted in the cost reduction proposal shall constitute full compensation for the performance of WORK. No claims for additional costs as a result of the changes specified in the cost reduction proposal shall be allowed.
- J. The OWNER reserves the right to adopt and utilize any approved cost reduction proposal for general use on any contract administered when it is determined suitable for such application. Cost reduction proposals identical, similar, or previously submitted will not be accepted for consideration if acceptance and compensation has previously been approved. The OWNER reserves the right to use all or part of any cost reduction proposal without obligation or compensation of any kind to the CONTRACTOR.
- K. The CONTRACTOR shall bear the costs, if any, to revise all Bonds and insurance requirements for the Project, to include the cost reduction WORK.

END OF SECTION

SECTION 00800 - SUPPLEMENTARY GENERAL CONDITIONS

GENERAL. These Supplementary General Conditions make additions, deletions, or revisions to the General Conditions as indicated herein. All provisions which are not so added, deleted, or revised remain in full force and effect. Terms used in these Supplementary General Conditions which are defined in the General Conditions have the meanings assigned to them in the General Conditions.

SGC 1 DEFINITIONS. *Remove* the definition for Contract Documents and *replace* with the following:

Contract Documents – The Table of Contents, Notice Inviting Bids, Instructions to Bidders, Bid Forms (including the Bid, Bid Schedule(s), Subcontractor Report, Bid Bond, and all required certificates and affidavits), Agreement, Performance Bond, Payment Bond, General Conditions, Supplementary General Conditions, Alaska Labor Standards, Reporting, and Prevailing Wage Rate Determination, Special Provisions, Standard Specifications, Technical Specifications, Drawings, Permits, and all Addenda, and Change Orders executed pursuant to the provisions of the Contract Documents.

SGC 2.2 COPIES OF DOCUMENTS. *Add* the following:

The OWNER shall furnish to the CONTRACTOR two (2) hard copies of the Contract Documents, which will include bound reduced Drawings, and electronic files of the documents in pdf format. Additional copies of contract documents are the responsibility of the contractor.

SGC 4.2 PHYSICAL CONDITIONS - SUBSURFACE AND EXISTING STRUCTURES. *Add* the following:

- C. In the preparation of the Contract Documents, the Engineer of Record has relied upon field measurements and visual inspection of the existing structures and surface conditions.

SGC - 4.6 USE OF THE CBJ/STATE LEMON CREEK GRAVEL PIT. *Add* the following.

The CBJ/State Lemon Creek Gravel Pit is not available for this Project.

SGC 5.1 PERFORMANCE, PAYMENT, AND OTHER BONDS. The Contractor shall furnish Performance and Payment Bonds in the amount of 100% of the Bid.

SGC 5.2 INSURANCE AMOUNTS. The limits of liability for the insurance required by Paragraph 5.2 of the General Conditions shall provide coverage for not less than the following amounts or greater where required by Laws and Regulations. The CONTRACTOR must provide certification of proper insurance coverage and amendatory endorsements or copies of the applicable policy language affecting coverage required in this agreement to the City and Borough of Juneau. All certificates of insurance supplied to the OWNER shall state that the OWNER is named as “**Additional Insured for any and all work performed for the City & Borough of Juneau**” for the **Commercial General Liability policy and any other policies, if required in this Section.** NOTE: This requirement has changed. The OWNER no longer requires certificates of insurance referencing project names and contract numbers.

Delete paragraph C and *Replace* with the following paragraph C:

- C. The CONTRACTOR shall furnish the OWNER with certificates showing the type, amount, class of operations covered, effective dates and dates of expiration of policies. Failure of CBJ to demand such certificate or other evidence of full compliance with these insurance requirements or failure of CBJ to identify a deficiency from evidence that is provided shall not be construed as a waiver of the

SECTION 00800 - SUPPLEMENTARY GENERAL CONDITIONS

obligation of the Contractor to maintain the insurance required by this contract. The coverage afforded will not be cancelled, reduced in coverage, or renewal refused until at least 30 days' prior written notice has been given to the OWNER by the CONTRACTOR. **All such insurance required herein (except for Workers' Compensation and Employer's Liability) shall name the OWNER, its Consultants and subconsultants and their officers, directors, agents, and employees as "additional insureds" under the policies.**

The CONTRACTOR shall purchase and maintain the following insurance:

1. Workers' Compensation and Employer's Liability. This insurance shall protect the CONTRACTOR against all claims under applicable state workers' compensation laws. The CONTRACTOR shall also be protected against claims for injury, disease, or death of employees which, for any reason, may not fall within the provisions of a Workers' Compensation law. The CONTRACTOR shall require each Subcontractor similarly to provide Workers' Compensation Insurance for all of the latter's employees to be engaged in such work unless such employees are covered by the protection afforded by the CONTRACTOR's Workers' Compensation Insurance. In case any class of employees is not protected, under the Workers' Compensation Statute, the CONTRACTOR shall provide and shall cause each subcontractor to provide adequate employer's liability insurance for the protection of such of its employees as are not otherwise protected. **The CONTRACTOR grants a waiver of any right to subrogation against the OWNER by virtue of the payment of any loss under such insurance.** This provision applies regardless of whether or not the OWNER has received a waiver of subrogation endorsement from the insurer.

Workers' Compensation: (under Paragraph 5.2C.1 of the General Conditions) as in accordance with AS 23.30.045:

- a. State: Statutory
- b. Applicable Federal (e.g., Longshore): Statutory

Note: If the WORK called for in the Contract Documents involves work in or on any navigable waters, the CONTRACTOR shall provide Workers' Compensation coverage which shall include coverage under the Longshore and Harbor Workers' Compensation Act, the Jones Act, and any other coverage required under Federal or State laws pertaining to workers in or on navigable waters.

- a. Employers Liability
 - Bodily Injury by Accident: \$1,000,000.00 Each Accident
 - Bodily Injury by Disease: \$1,000,000.00 Each Employee
 - Bodily Injury by Disease: \$1,000,000.00 Policy Limit

- 1. CONTRACTOR agrees to waive all rights of subrogation against the OWNER for WORK performed under contract.
- 2. If CONTRACTOR directly utilizes labor outside of the State of Alaska in the prosecution of the WORK, "Other States" endorsement shall be required as a condition of the contract.

2. Commercial General Liability (CGL), including products and completed operations, property damage, bodily injury and personal and advertising injury, with limits no less than \$1,000,000 each occurrence and \$2,000,000 aggregate. (under Paragraph 5.2C.2 of the General Conditions) **This insurance policy is to contain, or be endorsed to contain, additional**

SECTION 00800 - SUPPLEMENTARY GENERAL CONDITIONS

insured status for the CBJ, its officers, officials, employees, and volunteers. If Additional insured status is provided in the form of an endorsement to the Contractor's insurance, the endorsement shall be at least as broad as ISO Form CG 20 10 11 85 or **both** CG 20 10, CG 20 26, CG 20 33, or CG 20 38; **and** CG 20 37 forms if later revisions used).

3. Commercial Automobile Liability: (under Paragraph 5.2C.3 of the General Conditions) including Owned, Hired, and Non-Owned Vehicles:

Combined Single Limit, Bodily Injury and Property Damage \$1,000,000.00

This insurance policy is to contain, or be endorsed to contain, additional insured status for the CBJ, its officers, officials, employees, and volunteers The CONTRACTOR shall require each Subcontractor similarly to provide Commercial Automobile Liability Insurance for all of the latter's employees to be engaged in such WORK unless such employees are covered by the protection afforded by the CONTRACTOR's Commercial Automobile Liability Insurance.

Add the following paragraphs:

- C. Builder's Risk: (under Paragraph 5.2C.5 of the General Conditions) in an amount equal to the completed value of the BID. This policy shall include the OWNER as a named insured.
- D. All Subcontractors are required to secure and maintain the insurance coverages listed above, unless otherwise noted.
- E. If the CONTRACTOR maintains higher limits than the minimums shown above, the OWNER requires and shall be entitled to coverage for the higher limits maintained by the CONTRACTOR. Any available insurance proceeds in excess of the specified minimum limits of insurance and coverage shall be available to the OWNER.
- F. Policies shall also specify insurance provided by CONTRACTOR will be considered primary and not contributory to any other insurance available to the OWNER.
- G. Should any of the policies described above be cancelled before the expiration date thereof, notice will be delivered in accordance with the policy provisions.

SGC 6.5 CONCERNING SUBCONTRACTORS, SUPPLIERS, AND OTHERS. *Add* the following:

- B. The CONTRACTOR shall perform not less than 25% of the WORK with its own forces (i.e., without subcontracting). The 25% requirement shall be understood to mean that the CONTRACTOR shall perform, with its own organization, WORK amounting to at least 25% of the original contract amount. The 25% requirement will be calculated based upon the total of the subcontract amounts submitted for Contract Award, and any other information requested by the OWNER from the apparent low Bidder.

SGC 6.5 CONCERNING SUBCONTRACTORS, SUPPLIERS, AND OTHERS, *Add* the following paragraph:

- C. CONTRACTOR must pay Subcontractors and/or Suppliers within 30 days of receiving payment from the OWNER, if that payment was made for Work performed by the Subcontractor and/or materials received. Failure to pay Subcontractors within 30 days of receiving payment from which Subcontractor

SECTION 00800 - SUPPLEMENTARY GENERAL CONDITIONS

and/or Supplier is to be paid may result in the OWNER initiating debarment proceedings as prescribed in the City and Borough of Juneau Purchasing Code. *The 30 day City and Borough of Juneau requirement does not supersede AS 36.90.210.*

SGC 6.6 PERMITS, *Add* the following paragraph:

- D. Contractor is responsible for obtaining a Hot Works permit from the CBJ Permit Center, if performing work which requires such a permit. Work requiring a Hot Works Permit includes but is not limited to the following: cutting, welding, Thermit welding, brazing, soldering, grinding, thermal spraying, thawing pipe, installation of torch-applied roof systems or any other similar activity.

SGC 11.1 CHANGE OF CONTRACT PRICE. *Change* paragraph C., subparagraph 2, to read:

2. By mutual acceptance of a lump sum, which includes a maximum allowance for overhead and profit in accordance with Paragraph 11.4.

SGC 14.3 APPLICATION FOR PROGRESS PAYMENT. Paragraph D.

- D. The Value of Materials Stored at the site shall be an amount equal to 85%.

SGC 14.9 FINAL PAYMENT AND ACCEPTANCE. *Add* the following paragraph:

- C. Prior to the final payment the CONTRACTOR shall contact the Alaska Department of Labor and Workforce Development (ADOL) and provide the OWNER with clearance from the ADOL for the CONTRACTOR and all Subcontractors that have worked on the Project. This clearance shall indicate that all Employment Security Taxes have been paid. A sample form for this purpose is at the end of this section. The CONTRACTOR shall also submit a "NOTICE OF COMPLETION OF PUBLIC WORKS" signed by ADOL.

SGC 16.8 CERTIFIED PAYROLLS. *Change* paragraph A. to read:

- A. All CONTRACTORS or Subcontractors who perform work on a public construction contract for the OWNER shall file a certified payroll with Alaska Department of Labor. See Section 00830 - Alaska Labor Standards, Reporting, and Prevailing Wage Rate Determination.

Add the following SGC 16.12.

SGC 16.12 EQUAL EMPLOYMENT OPPORTUNITY (EEO)

The CONTRACTOR may not discriminate against any employee or applicant for employment because of race, religion, color, national origin, age, disability, sex, sexual orientation, gender identity, gender expression, marital status, changes in marital status, pregnancy or parenthood. The CONTRACTOR shall post a notice setting out the provisions of this paragraph in a conspicuous place available to employees and applicants for employment.

The CONTRACTOR and each Subcontractor shall state in all solicitations and advertisements for employees to work on this Project, that it is an Equal Opportunity Employer and that all qualified applicants will receive consideration for employment without regard to race, religion, color, national origin, age, disability, sex, sexual orientation, gender identity, gender expression, marital status, changes in marital status, pregnancy or parenthood.

SECTION 00800 - SUPPLEMENTARY GENERAL CONDITIONS

The CONTRACTOR shall include the provisions of this EEO article in every contract relating to this Project and shall require the inclusion of these provisions in every agreement entered into for this Project, so that those provisions will be binding upon the CONTRACTOR and each Subcontractor.



Tax Clearance Request Form for Contractors

Date of request: _____

Business name of the contractor a Tax Clearance is being requested for: _____

Business address: _____

Business contact phone number: _____

Federal Identification Number: _____

Alaska Employer Account Number: _____

Specific time period a tax clearance is being requested for (i.e. beginning and ending date of a subcontract agreement):

Subcontract project name: _____

Name and address of the person this Tax Clearance is to be returned to: _____

Comments or additional information: _____

For agency use only:

- Tax Clearance is granted
Tax Clearance is not granted (please have employer contact the department)
No account on file, liability unknown (please have employer contact the department)
Employer has stated no employees, Tax Clearance not required.

Agency representative signature: _____ Date: _____

Agency representative title: _____

We are an equal opportunity employer/program. Auxiliary aids and services are available upon request to individuals with disabilities. labor.alaska.gov/estax

**SECTION 00830 - ALASKA LABOR STANDARDS, REPORTING, AND
PREVAILING WAGE RATE DETERMINATION**

State of Alaska, Department of Labor, Laborers' and Mechanics' Minimum Rates of Pay, AS 36.05.010 and AS 36.05.050, Wage and Hour Administration Pamphlet No. 600, the latest edition published by the State of Alaska, Department of Labor inclusive, is provided in its entirety in SECTION 00830 – APPENDIX A.

The rates that are in effect 10 days prior to the final date for submission of bids are the rates that will apply to this project. These rates will apply for 24 calendar months from the date the project is awarded to a prime contractor. At the end of the initial 24-month period, the latest wage rates issued by the Alaska Department of Labor shall become effective for the next 24-month period. This process repeats itself until the project is completed.

The CONTRACTOR is responsible for contacting the Alaska Department of Labor to determine compliance with current regulations.

Correspondence regarding Title 36 requirements may be submitted to ADOL electronically or paper copies can be submitted by mail. To submit Title 36 documents and certified payrolls electronically, go to <https://myalaska.state.ak.us/home/app>.

The CONTRACTOR and each Subcontractor shall submit Certified Payrolls to the CBJ Contract Administrator upon request. If the requested Certified Payrolls are not received by the Contract Administrator within five (5) working days, the Contract Administrator will request the Certified Payrolls from ADOL. The CONTRACTOR shall be responsible for all costs charged by ADOL for delivery of the requested Certified Payrolls, including those costs for Subcontractors.

Within 10 Days of "Notice of Award/Notice to Proceed" make a list of all Subcontractors. Include their name, address, phone, estimated subcontract amount, and estimated start and finish dates. Send this list to the Wage and Hour Section (contact information below).

Certified Payrolls must be submitted every two weeks. Before the second Friday, each CONTRACTOR and Subcontractor must file Certified Payrolls with Statements of Compliance for the previous two weeks. Indicate **"Start"** on your first payroll, and **"Final"** on your last payroll for this Project.

As part of the **final payment request package**, CONTRACTOR must submit a "NOTICE OF COMPLETION OF PUBLIC WORKS" form signed by ADOL personnel.

Contact Information:

Wage and Hour Section
State of Alaska
Department of Labor and Workforce Development
Labor Standards and Safety Division and
Wage and Hour Administration
P.O. Box 11149
Juneau, AK 99811-1149
907-465-4842
<http://labor.state.ak.us/lss/home.htm>

Caleb Comas, Contract Administrator
City and Borough of Juneau
155 S. Seward Street
Juneau, AK 99801
(907) 586-0800 ext. 4196
caleb.comas@juneau.org

SECTION 00830

APPENDIX A

Laborers' & Mechanics'
Minimum Rates of Pay

Pamphlet 600

Effective April 1, 2022



MINIMUM RATES OF PAY For Laborers and Mechanics

Effective April 1, 2022

Issue 44

PAMPHLET No. 600

Title 36. Public Contracts

AS 36.05

DEPARTMENT OF LABOR
AND WORKFORCE DEVELOPMENT
Wage and Hour

- This page intentionally left blank -



April 1, 2022

TO ALL CONTRACTING AGENCIES:

At the Alaska Department of Labor and Workforce Development, our goal is putting Alaskans to work. This pamphlet is designed to help contractors awarded public construction contracts understand the most significant laws of the State of Alaska pertaining to prevailing wage.

This pamphlet identifies current prevailing wage rates for public construction contracts (any construction projects awarded for the State of Alaska or its political subdivisions, such as local governments and certain non-profit organizations). Because these rates may change in a subsequent determination, please be sure you are using the appropriate rates. The rates published in this edition become effective April 1, 2022.

The prevailing wage rates contained in this pamphlet are applicable to public construction projects with a final bid date of April 11, 2022, or later. As the law now provides, these rates will remain stable during the life of a contract or for 24 calendar months, whichever is shorter. **The 24-month period begins on the date the prime contract is awarded.** Upon expiration of the initial 24-month period, the latest wage rates issued by the department shall become effective for a subsequent 24-month period or until the original contract is completed, whichever occurs first. This process shall be repeated until the original contract is completed.

The term "original contract" means the signed contract that resulted from the original bid and any amendments, including changes of work scope, additions, extensions, change orders, and other instruments agreed to by the parties that have not been subject to subsequent open bid procedures.

If a higher federal rate is required due to partial federal funding or other federal participation, the higher rate must be paid.

For additional copies of this pamphlet go to: <http://labor.state.ak.us/lss/pamp600.htm>

For questions regarding prevailing wage or employment preference requirements, please contact the nearest Wage and Hour office. These offices are listed on Page x.

Sincerely,

Handwritten signature of Tamika L. Ledbetter in black ink.

Dr. Tamika L. Ledbetter
Commissioner

- This page intentionally left blank -

Table of Contents

Excerpts from Alaska Law

Sec. 36.05.005. Applicability.....	iv
Sec. 36.05.010. Wage rates on public construction.	iv
Sec. 36.05.040. Filing schedule of employees, wages paid and other information	iv
Sec. 36.05.045. Notice of work and completion; withholding of payment	iv
Sec. 36.05.060. Penalty for violation of this chapter	v
Sec. 36.05.070. Wage rates in specifications and contracts for public works	v
Sec. 36.05.080. Failure to pay agreed wages.....	v
Sec. 36.05.090. Payment of wages from withheld payments and listing contractors who violate contracts	v
Sec. 36.05.900. Definition.. ..	vi

Excerpts from Alaska Administrative Code

8 AAC 30.051. Purpose	vi
8 AAC 30.052. Board and lodging; remote sites	vi
8 AAC 30.054. Per diem instead of board and lodging	vi
8 AAC 30.056. Alternative arrangement.....	vii
8 AAC 30.900. General definitions (selected excerpts).....	vii

Additional Information

Per Diem	vii
Laborer Classification Clarification.....	viii
Apprentice Rates.....	viii
Fringe Benefit Plans.....	viii
Special Prevailing Wage Rate Determination.....	ix
Alaska Employment Preference Information.....	ix
Labor Standards and Safety Notice Requests	x
Debarment List	x

Wage Rates Pages 1-26

Shipyard Rate Addendum.....Pages 28

Note to Readers: The statutes and administrative regulations listed in this publication were taken from the official codes, as of the effective date of the publication. However, there may be errors or omissions that have not been identified and changes that occurred after the publication was printed. This publication is intended as an informational guide only and is not intended to serve as a precise statement of the statutes and regulations of the State of Alaska. To be certain of current laws and regulations, please refer to the official codes.

EXCERPTS FROM ALASKA LAW

Sec. 36.05.005. Applicability.

This chapter applies only to a public construction contract that exceeds \$25,000.

Sec. 36.05.010. Wage rates on public construction.

A contractor or subcontractor who performs work on a public construction contract in the state shall pay not less than the current prevailing rate of wages for work of a similar nature in the region in which the work is done. The current prevailing rate of wages is that contained in the latest determination of prevailing rate of wages issued by the Department of Labor and Workforce Development at least 10 days before the final date for submission of bids for the contract. The rate shall remain in effect for the life of the contract or for 24 calendar months, whichever is shorter. At the end of the initial 24-month period, if new wage determinations have been issued by the department, the latest wage determination shall become effective for the next 24-month period or until the contract is completed, whichever occurs first. This process shall be repeated until the contract is completed.

Sec. 36.05.040. Filing schedule of employees, wages paid, and other information.

All contractors or subcontractors who perform work on a public construction contract for the state or for a political subdivision of the state shall, before the Friday of every second week, file with the Department of Labor and Workforce Development a sworn affidavit for the previous reporting period, setting out in detail the number of persons employed, wages paid, job classification of each employee, hours worked each day and week, and other information on a form provided by the Department of Labor and Workforce Development.

Sec. 36.05.045. Notice of work and completion; withholding of payment.

- (a) Before commencing work on a public construction contract, the person entering into the contract with a contracting agency shall designate a primary contractor for purposes of this section. Before work commences, the primary contractor shall file a notice of work with the Department of Labor and Workforce Development. The notice of work must list work to be performed under the public construction contract by each contractor who will perform any portion of work on the contract and the contract price being paid to each contractor. The primary contractor shall pay all filing fees for each contractor performing work on the contract, including a filing fee based on the contract price being paid for work performed by the primary contractor's employees. The filing fee payable shall be the sum of all fees calculated for each contractor. The filing fee shall be one percent of each contractor's contract price. The total filing fee payable by the primary contractor under this subsection may not exceed \$5,000. In this subsection, "contractor" means an employer who is using employees to perform work on the public construction contract under the contract or a subcontract.
- (b) Upon completion of all work on the public construction contract, the primary contractor shall file with the Department of Labor and Workforce Development a notice of completion together with payment of any additional filing fees owed due to increased contract amounts. Within 30 days after the department's receipt of the primary contractor's notice of completion, the department shall inform the contracting agency of the amount, if any, to be withheld from the final payment.
- (c) A contracting agency
 - (1) may release final payment of a public construction contract to the extent that the agency has received verification from the Department of Labor and Workforce Development that
 - (A) the primary contractor has complied with (a) and (b) of this section;
 - (B) the Department of Labor and Workforce Development is not conducting an investigation under this title; and
 - (C) the Department of Labor and Workforce Development has not issued a notice of a violation of this chapter to the primary contractor or any other contractors working on the public construction contract; and

- (2) shall withhold from the final payment an amount sufficient to pay the department's estimate of what may be needed to compensate the employees of any contractors under investigation on this construction contract, and any unpaid filing fees.
- (d) The notice and filing fee required under (a) of this section may be filed after work has begun if
 - (1) The public construction contract is for work undertaken in immediate response to an emergency; and
 - (2) The notice and fees are filed not later than 14 days after the work has begun.
- (e) A false statement made on a notice required by this section is punishable under AS 11.56.210.

Sec. 36.05.060. Penalty for violation of this chapter.

A contractor who violates this chapter is guilty of a misdemeanor and upon conviction is punishable by a fine of not less than \$100 nor more than \$1,000, or by imprisonment for not less than 10 days nor more than 90 days, or by both. Each day a violation exists constitutes a separate offense.

Sec. 36.05.070. Wage rates in specifications and contracts for public works.

- (a) The advertised specifications for a public construction contract that requires or involves the employment of mechanics, laborers, or field surveyors must contain a provision stating the minimum wages to be paid various classes of laborers, mechanics, or field surveyors and that the rate of wages shall be adjusted to the wage rate under AS 36.05.010.
- (b) Repealed by §17 ch 142 SLA 1972.
- (c) A public construction contract under (a) of this section must contain provisions that
 - (1) the contractor or subcontractors of the contractor shall pay all employees unconditionally and not less than once a week;
 - (2) wages may not be less than those stated in the advertised specifications, regardless of the contractual relationship between the contractor or subcontractors and laborers, mechanics, or field surveyors;
 - (3) the scale of wages to be paid shall be posted by the contractor in a prominent and easily accessible place at the site of the work;
 - (4) the state or a political subdivision shall withhold so much of the accrued payments as is necessary to pay to laborers, mechanics, or field surveyors employed by the contractor or subcontractors the difference between
 - (A) the rates of wages required by the contract to be paid laborers, mechanics, or field surveyors on the work; and
 - (B) the rates of wages in fact received by laborers, mechanics, or field surveyors.

Sec. 36.05.080. Failure to pay agreed wages.

Every contract within the scope of AS 36.05.070 shall contain a provision that if it is found that a laborer, mechanic, or field surveyor employed by the contractor or subcontractor has been or is being paid a rate of wages less than the rate of wages required by the contract to be paid, the state or its political subdivision may, by written notice to the contractor, terminate the contractor's right to proceed with the work or the part of the work for which there is a failure to pay the required wages and to prosecute the work to completion by contract or otherwise, and the contractor and the contractor's sureties are liable to the state or its political subdivision for excess costs for completing the work.

Sec. 36.05.090. Payment of wages from withheld payments and listing contractors who violate contracts.

- (a) The state disbursing officer in the case of a state public construction contract and the local fiscal officer in the case of a political subdivision public construction contract shall pay directly to laborers, mechanics, or field surveyors from accrued payments withheld under the terms of the contract the wages due laborers, mechanics, or field surveyors under AS 36.05.070.
- (b) The state disbursing officer or the local fiscal officer shall distribute to all departments of the state government and to all political subdivisions of the state a list giving the names of persons who have disregarded their obligations to employees. A person appearing on this list and a firm, corporation, partnership, or association in which the person has an interest may not work as a contractor or

subcontractor on a public construction contract for the state or a political subdivision of the state until three years after the date of publication of the list. If the accrued payments withheld under the contract are insufficient to reimburse all the laborers, mechanics, or field surveyors with respect to whom there has been a failure to pay the wages required under AS 36.05.070, the laborers, mechanics, or field surveyors have the right of action or intervention or both against the contractor and the contractor's sureties conferred by law upon persons furnishing labor or materials, and in the proceedings it is not a defense that the laborers, mechanics, or field surveyors accepted or agreed to accept less than the required rate of wages or voluntarily made refunds.

Sec. 36.05.900. Definition.

In this chapter, "contracting agency" means the state or a political subdivision of the state that has entered into a public construction contract with a contractor.

EXCERPTS FROM ALASKA ADMINISTRATIVE CODE

*****Notice:** Regulations relating to board and lodging and per diem went into effect on November 25, 2018. The new regulations are excerpted here***

8 AAC 30.051. Purpose. The purpose of 8 AAC 30.052 – 8 AAC 30.056 is to ensure that wages paid to laborers, mechanics, and field surveyors do not fall below the prevailing rate of pay.

8 AAC 30.052. Board and lodging; remote sites. (a) A contractor on a public construction project located 65 or more road miles from the international airport closest to the project area in either Fairbanks, Juneau, or Anchorage, or that is inaccessible by road in a two-wheel drive vehicle, shall provide adequate board and lodging to each laborer, mechanic, or field surveyor while the person is employed on the project. If commercial lodging facilities are not available, the contractor shall provide temporary lodging facilities. Lodging facilities must comply with all applicable state and federal laws. For a highway project, the location of the project is measured from the midpoint of the project.

(b) A contractor is not required to provide board and lodging:

(1) to a laborer, mechanic, or field surveyor who is a domiciled resident of the project area; or

(2) on a laborer, mechanic, or field surveyor's scheduled days off, when the person can reasonably travel between the project and the person's permanent residence; for the purposes of this paragraph, "scheduled day off" means a day in which a person does not perform work on-site, is not required to remain at or near the job location for the benefit of the contractor, and is informed of the day off at least seven days before the day off.

(c) Upon a contractor's written request, the commissioner may waive the requirements of (a) of this section where:

(1) the project is inaccessible by road in a two-wheel drive vehicle, but the laborer, mechanic, or field surveyor can reasonably travel between the project and the person's permanent residence within one hour; or

(2) a laborer, mechanic, or field surveyor is not a domiciled resident of the project area, but has established permanent residence, with the intent to remain indefinitely, within 65 road miles of the project, or for a highway project, the mid-point of the project.

8 AAC 30.054. Per diem instead of board and lodging. (a) A contractor may pay a laborer, mechanic, or field surveyor per diem instead of providing board and lodging, when the following conditions are met:

(1) the department determines that per diem instead of board and lodging is an established practice for the work classification; the department shall publish and periodically revise its determinations in the pamphlet *Laborers and Mechanics Minimum Rates of Pay*;

(2) the contractor pays each laborer, mechanic, or field surveyor the appropriate per diem rate as published and periodically revised in the pamphlet *Laborers and Mechanics Minimum Rates of Pay*; and

(3) the contractor pays the per diem to each laborer, mechanic, or field surveyor on the same day that wages are paid.

(b) A contractor may not pay per diem instead of board and lodging on a highway project located

- (1) west of Livengood on the Elliot Highway, AK-2;
- (2) on the Dalton Highway, AK-11;
- (3) north of milepost 20 on the Taylor Highway, AK-5;
- (4) east of Chicken on the Top of the World Highway; or
- (5) south of Tetlin Junction to the Alaska-Canada border on the Alaska Highway, AK-2.

8 AAC 30.056. Alternative arrangement. Upon a contractor's written request, the commissioner may approve an alternative board and lodging or per diem arrangement, provided

- (1) the arrangement does not reduce the laborer, mechanic, or field surveyor's wages below the prevailing wage rate; and
- (2) the laborer, mechanic, or field surveyor voluntarily enters into and signs the written arrangement; a labor organization representing laborers, mechanics, or field surveyors may enter into the written agreement on their behalf.

8 AAC 30.900. General definitions (selected excerpts only):

In this chapter and in AS 36

(22) "domiciled resident" means a person living within 65 road miles of a public construction project, or in the case of a highway project, the mid-point of the project, for at least 12 consecutive months prior to the award of the public construction project;

(23) "employed on the project" means the time period from the date the laborer, mechanic, or field surveyor first reports on-site to the project through the final date the person reports on-site to the project.

ADDITIONAL INFORMATION

PER DIEM

Notice: New regulations relating to board and lodging and per diem went into effect on November 25, 2018. The regulations provide a comprehensive set of requirements for the provision of board and lodging or per diem for workers on remote projects. Please refer to Alaska Administrative Code 8 AAC Chapter 30 and read the chapter carefully.

The Alaska Department of Labor and Workforce Development has determined that per diem is an established work practice for certain work classifications. These classifications are indicated throughout the Pamphlet by an asterisk (*) under the classification title. If all of the conditions of 8 AAC 30.054 are met, an employer may pay workers in these classifications per diem instead of providing board and lodging on a remote project.

Per Diem Rate: As of May 1st, 2019, the minimum per diem rate is \$100.00 per day, or part thereof, the worker is employed on the project. In the event that a contractor provides lodging facilities, but no meals, the department will accept a payment of \$48 per day for meals to meet the per diem requirements.

LABORER CLASSIFICATION CLARIFICATION

The laborer rates categorized in class code S1201-S1206 apply in one area of Alaska; the area that is south of N63 latitude and west of W138 Longitude. The laborer rates categorized in class code N1201-N1206 apply in two areas of Alaska; the Alaska areas north of N63 latitude and east of W138 longitude. The following graphic representations should assist with clarifying the applicable wage rate categories:

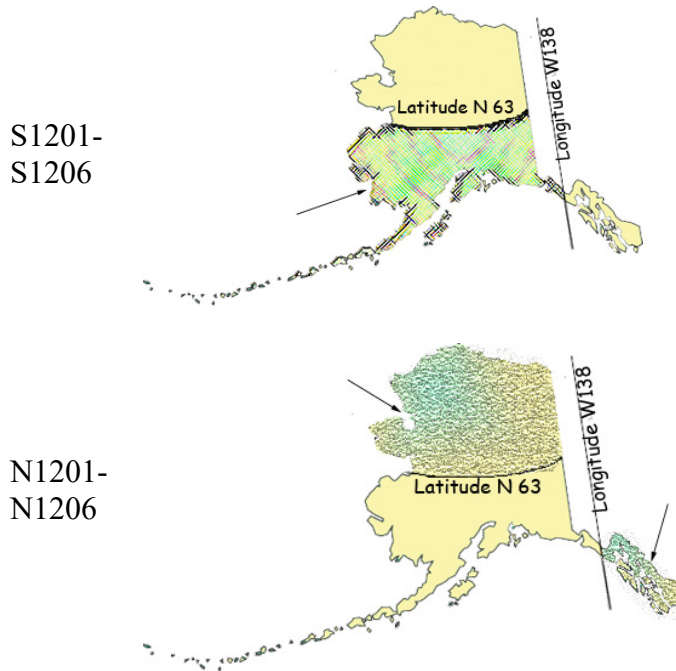

APPRENTICE RATES

Apprentice rates at less than the minimum prevailing rates may be paid to apprentices according to an apprentice program which has been registered and approved by the Commissioner of the Alaska Department of Labor and Workforce Development in writing or according to a bona fide apprenticeship program registered with the U.S. Department of Labor, Office of Apprenticeship Training. **Any employee listed on a payroll at an apprentice wage rate who is not registered as above shall be paid the journeyman prevailing minimum wage in that work classification.** Wage rates are based on prevailing crew makeup practices in Alaska and apply to work performed regardless of either the quality of the work performed by the employee or the titles or classifications which may be assigned to individual employees.

FRINGE BENEFIT PLANS

Contractors/subcontractors may compensate fringe benefits to their employees in any one of three methods. The fringe benefits may be paid into a union trust fund, into an approved benefit plan, or paid directly on the paycheck as gross wages.

Where fringe benefits are paid into approved plans, funds, or programs including union trust funds, the payments must be contributed at least monthly. If contractors submit their own payroll forms and are paying fringe benefits into approved plans, funds, or programs, the employer's certification must include, in addition to those requirements of 8 AAC 30.020(c), a statement that fringe benefit payments have been or will be paid at least monthly. Contractors who pay fringe benefits to a plan must ensure the plan is one approved by the Internal Revenue Service and that the plan meets the requirements of 8 AAC 30.025 (eff. 3/2/08) in order for payments to be credited toward the prevailing wage obligation.

SPECIAL PREVAILING WAGE RATE DETERMINATION

Special prevailing wage rate determinations may be requested for special projects or a special worker classification if the work to be performed does not conform to traditional public construction for which a prevailing wage rate has been established under 8 AAC 30.050(a) of this section. Requests for special wage rate determinations must be in writing and filed with the Commissioner at least 30 days before the award of the contract. An applicant for a special wage rate determination shall have the responsibility to support the necessity for the special rate. An application for a special wage rate determination filed under this section must contain:

- (1) a specification of the contract or project on which the special rates will apply and a description of the work to be performed;
- (2) a brief narrative explaining why special wage rates are necessary;
- (3) the job class or classes involved;
- (4) the special wage rates the applicant is requesting, including survey or other relevant wage data to support the requested rates;
- (5) the approximate number of employees who would be affected; and
- (6) any other information which might be helpful in determining if special wage rates are appropriate.

Requests made pursuant to the above should be addressed to:

Director
Alaska Department of Labor and Workforce Development
Labor Standards and Safety Division
Wage and Hour
P.O. Box 111149
Juneau, AK 99811-1149

-or-

Email: statewide.wagehour@alaska.gov

EMPLOYMENT PREFERENCE INFORMATION

In October 2019, the Alaska Attorney General issued a formal opinion stating that the Alaska Statutes 36.10.150 of the State’s 90% Employment Preference law, also known as the Alaska Resident Hire law, violates both the U.S. and Alaska Constitutions. As a result, the state has stopped all enforcement activity.

A copy of the Attorney General opinion is found here:

http://law.alaska.gov/pdf/opinions/opinions_2019/19-005_AK-hire.pdf

**Alaska Department of Labor and Workforce Development
Labor Standards and Safety Division
Wage and Hour**

Web site: <http://labor.state.ak.us/lss/pamp600.htm>

Anchorage

1251 Muldoon Road, Suite 113
Anchorage, Alaska 99504-2098
Phone: (907) 269-4900

Email:
statewide.wagehour@alaska.gov

Juneau

PO Box 111149
Juneau, Alaska 99811
Phone: (907) 465-4842

Email:
statewide.wagehour@alaska.gov

Fairbanks

Regional State Office Building
675 7th Ave., Station J-1
Fairbanks, Alaska 99701-4593
Phone: (907) 451-2886

Email:
statewide.wagehour@alaska.gov

LABOR STANDARDS AND SAFETY NOTICE REQUESTS

If you would like to receive Wage and Hour or Mechanical Inspection **regulation notices** or **publications information**, they are available via electronic mail, by signing up in the GovDelivery System, <https://public.govdelivery.com/accounts/AKDOL/subscriber/new> and selecting topics *LSS – Wage and Hour – Forms and Publications*, *LSS – Mechanical Inspection Regulations*, or *LSS – Wage and Hour Regulations*.

Publications are also available online at <http://labor.alaska.gov/lss/home.htm>

DEBARMENT LIST

AS 36.05.090(b) states that “the state disbursing officer or the local fiscal officer shall distribute to all departments of the state government and to all political subdivisions of the state a list giving the names of persons who have disregarded their obligations to employees.”

A person appearing on the following debarment list and a firm, corporation, partnership, or association in which the person has an interest may not work as a contractor or subcontractor on a public construction contract for the state or a political subdivision of the state for three years from the date of debarment.

Company Name

Debarment Expires

No companies are currently debarred.

Laborers' & Mechanics' Minimum Rates of Pay

Class Code	Classification of Laborers & Mechanics	BHR	H&W	PEN	TRN	Other	Benefits	THR
------------	--	-----	-----	-----	-----	-------	----------	-----

Boilermakers
*See per diem note on last page

A0101	Boilermaker (journeyman)	46.97	8.57	18.08	1.90	VAC	SAF	80.11
						4.25	0.34	

Bricklayers & Blocklayers
*See per diem note on last page

A0201	Blocklayer	42.01	9.00	10.20	0.62	L&M		62.03
						0.20		

Bricklayer
Marble or Stone Mason
Refractory Worker (Firebrick, Plastic, Castable, and Gunitite Refractory Applications)
Terrazzo Worker
Tile Setter

A0202	Tuck Pointer Caulker	42.01	9.00	10.20	0.62	L&M		62.03
						0.20		

Cleaner (PCC)

A0203	Marble & Tile Finisher	35.84	9.00	10.20	0.62	L&M		55.86
						0.20		

Terrazzo Finisher

A0204	Torginal Applicator	35.84	9.00	10.20	0.62	L&M		55.86
						0.20		

Carpenters, Region I (North of 63 latitude)
*See per diem note on last page

N0301	Carpenter (journeyman)	42.34	10.08	15.23	1.75	L&M	SAF	69.80
						0.20	0.20	

Lather/Drywall/Acoustical

Carpenters, Region II (South of N63 latitude)
*See per diem note on last page

S0301	Carpenter (journeyman)	42.34	10.08	15.77	1.75	L&M	SAF	70.34
						0.20	0.20	

Lather/Drywall/Acoustical

Cement Masons
*See per diem note on last page

Wage benefits key: BHR=basic hourly rate; H&W=health and welfare; IAF=industry advancement fund; LEG=legal fund; L&M=labor/management fund; PEN=pension fund; SAF=safety; SUI=supplemental unemployment insurance; S&L=SUI & LEG combined; TRN=training; THR=total hourly rate; VAC=vacation

Cement Masons
 *See per diem note on last page

						L&M	
A0401	Group I, including:	40.13	8.70	11.80	1.43	0.10	62.16
	Application of Sealing Compound						
	Application of Underlayment						
	Building, General						
	Cement Finisher						
	Cement Mason (journeyman)						
	Concrete						
	Concrete Paving						
	Concrete Polishing						
	Concrete Repair						
	Curb & Gutter, Sidewalk						
	Curing of All Concrete						
	General Concrete Pour Tender						
	Grouting & Caulking of Tilt-Up Panels						
	Grouting of All Plates						
	Patching Concrete						
	Screed Pin Setter						
	Screeder or Rodder						
	Spackling/Skim Coating						

A0402	Group II, including:	40.13	8.70	11.80	1.43	0.10	62.16
--------------	----------------------	-------	------	-------	------	------	-------

Form Setter

						L&M	
A0403	Group III, including:	40.13	8.70	11.80	1.43	0.10	62.16

- Concrete Saw Cutter Operator (All Control Joints and Self-powered)
- Curb & Gutter Machine
- Floor Grinder
- Pneumatic Power Tools
- Power Chipping & Bushing
- Sand Blasting Architectural Finish
- Screed & Rodding Machine Operator
- Troweling Machine Operator (all concrete surfaces)

A0404	Group IV, including:	40.13	8.70	11.80	1.43	0.10	62.16
--------------	----------------------	-------	------	-------	------	------	-------

- Acoustical or Imitation Acoustical Finish
- Application of All Composition Mastic
- Application of All Epoxy Material
- Application of All Plastic Material
- Finish Colored Concrete
- Gunite Nozzleman
- Hand Powered Grinder

Wage benefits key: BHR=basic hourly rate; H&W=health and welfare; IAF=industry advancement fund; LEG=legal fund; L&M=labor/management fund; PEN=pension fund; SAF=safety; SUI=supplemental unemployment insurance; S&L=SUI & LEG combined; TRN=training; THR=total hourly rate; VAC=vacation

Class Code	Classification of Laborers & Mechanics	BHR	H&W	PEN	TRN	Other Benefits	THR
------------	--	-----	-----	-----	-----	----------------	-----

Cement Masons
*See per diem note on last page

A0404	Group IV, including:	40.13	8.70	11.80	1.43	L&M 0.10	62.16
	Preparing, scratching and browsing of all ceilings and walls, finished with terrazo or tile						
	Tunnel Worker						

A0405	Group V, including:	40.13	8.70	11.80	1.43	L&M 0.10	62.16
	Casting and finishing						
	EIFS Systems						
	Finishing of all interior and exterior plastering						
	Fireproofing (Pryocrete, Cafco, Albi-Clad, sprayed fiberglass)						
	Gypsum, Portland Cement						
	Kindred material and products						
	Operation and control of all types of plastering machines, including power tools and floats, used by the industry						
	Overcoating and maintenance of interior/exterior plaster surfaces						
	Plasterer						
	Veneer plastering process (Rapid Plaster, U.S.G. "Imperial Systems", and Pabcoat Systems")						
	Venetian plaster and color-integrated Italian/Middle-Eastern line plaster						

Culinary Workers

A0501	Baker/Cook	28.37	7.31	7.56		LEG	43.24
A0503	General Helper	25.07	7.31	7.56		LEG	39.94
	Housekeeper						
	Janitor						
	Kitchen Helper						
A0504	Head Cook	28.97	7.31	7.56		LEG	43.84
A0505	Head Housekeeper	25.45	7.31	7.56		LEG	40.32
	Head Kitchen Help						

Dredgemen
*See per diem note on last page

A0601	Assistant Engineer	42.76	11.05	13.75	1.00	L&M 0.10	0.05	68.71
	Craneman							

Wage benefits key: BHR=basic hourly rate; H&W=health and welfare; IAF=industry advancement fund; LEG=legal fund; L&M=labor/management fund; PEN=pension fund; SAF=safety; SUI=supplemental unemployment insurance; S&L=SUI & LEG combined; TRN=training; THR=total hourly rate; VAC=vacation

Class Code	Classification of Laborers & Mechanics	BHR	H&W	PEN	TRN	Other	Benefits	THR
------------	--	-----	-----	-----	-----	-------	----------	-----

Dredgemen
*See per diem note on last page

A0601	Assistant Engineer	42.76	11.05	13.75	1.00	L&M		68.71
	Electrical Generator Operator (primary pump/power barge/dredge)					0.10	0.05	
	Engineer							
	Welder							
A0602	Assistant Mate (deckhand)	41.60	11.05	13.75	1.00	L&M		67.55
						0.10	0.05	
A0603	Fireman	42.04	11.05	13.75	1.00	L&M		67.99
						0.10	0.05	
A0605	Leverman Clamshell	45.29	11.05	13.75	1.00	L&M		71.24
						0.10	0.05	
A0606	Leverman Hydraulic	43.53	11.05	13.75	1.00	L&M		69.48
						0.10	0.05	
A0607	Mate & Boatman	42.76	11.05	13.75	1.00	L&M		68.71
						0.10	0.05	
A0608	Oiler (dredge)	42.04	11.05	13.75	1.00	L&M		67.99
						0.10	0.05	

Electricians
*See per diem note on last page

A0701	Inside Cable Splicer	42.77	14.23	13.92	0.95	L&M		LEG	72.22
						0.20	0.15		
A0702	Inside Journeyman Wireman, including:	42.44	14.23	14.16	0.95	L&M		LEG	72.13
	Technicians (including use of drones in electrical construction)					0.20	0.15		
A0703	Power Cable Splicer	63.04	14.23	19.08	0.95	L&M		LEG	97.70
						0.25	0.15		
A0704	Tele Com Cable Splicer	50.53	14.23	17.17	0.95	L&M		LEG	83.23
						0.20	0.15		
A0705	Power Journeyman Lineman, including:	61.29	14.23	19.03	0.95	L&M		LEG	95.90
	Power Equipment Operator					0.25	0.15		
	Technician (including use of drones in electrical construction)								
A0706	Tele Com Journeyman Lineman, including:	48.78	14.23	17.11	0.95	L&M		LEG	81.42
	Technician (including use of drones in telecommunications construction)					0.20	0.15		
	Tele Com Equipment Operator								

Wage benefits key: BHR=basic hourly rate; H&W=health and welfare; IAF=industry advancement fund; LEG=legal fund; L&M=labor/management fund; PEN=pension fund; SAF=safety; SUI=supplemental unemployment insurance; S&L=SUI & LEG combined; TRN=training; THR=total hourly rate; VAC=vacation

Class Code	Classification of Laborers & Mechanics	BHR	H&W	PEN	TRN	Other	Benefits	THR
------------	--	-----	-----	-----	-----	-------	----------	-----

Electricians
*See per diem note on last page

A0707	Straight Line Installer - Repairman	48.78	14.23	17.11	0.95	L&M	LEG	81.42
A0708	Powderman	59.29	14.23	18.97	0.95	L&M	LEG	93.84
A0710	Material Handler	26.57	13.92	5.80	0.15	L&M	LEG	46.74
A0712	Tree Trimmer Groundman	29.12	14.23	13.35	0.15	L&M	LEG	57.15
A0713	Journeyman Tree Trimmer	38.05	14.23	13.62	0.15	L&M	LEG	66.35
A0714	Vegetation Control Sprayer	41.60	14.23	13.73	0.15	L&M	LEG	70.01
A0715	Inside Journeyman Communications CO/PBX	41.02	14.23	13.87	0.95	L&M	LEG	70.42

Elevator Workers
*See per diem note on last page

A0802	Elevator Constructor	44.21	16.02	20.21	0.65	L&M	VAC	86.59
A0803	Elevator Constructor Mechanic	63.16	16.02	20.21	0.65	L&M	VAC	107.65

Heat & Frost Insulators/Asbestos Workers
*See per diem note on last page

A0902	Asbestos Abatement-Mechanical Systems	39.50	9.24	11.12	1.20	IAF	LML	61.25
A0903	Asbestos Abatement/General Demolition All Systems	39.50	9.24	11.12	1.20	IAF	LML	61.25
A0904	Insulator, Group II	39.50	9.24	11.12	1.20	IAF	LML	61.25
A0905	Fire Stop	39.50	9.24	11.12	1.20	IAF	LML	61.25

IronWorkers
*See per diem note on last page

A1101	Ironworkers, including:	40.82	9.51	24.28	0.76	L&M	IAF	75.81
--------------	-------------------------	-------	------	-------	------	----------------	------------	-------

Wage benefits key: BHR=basic hourly rate; H&W=health and welfare; IAF=industry advancement fund; LEG=legal fund; L&M=labor/management fund; PEN=pension fund; SAF=safety; SUI=supplemental unemployment insurance; S&L=SUI & LEG combined; TRN=training; THR=total hourly rate; VAC=vacation

IronWorkers
 *See per diem note on last page

						L&M	IAF	
A1101	Ironworkers, including:	40.82	9.51	24.28	0.76	0.20	0.24	75.81
	Bender Operators							
	Bridge & Structural							
	Hangar Doors							
	Hollow Metal Doors							
	Industrial Doors							
	Machinery Mover							
	Ornamental							
	Reinforcing							
	Rigger							
	Sheeter							
	Signalman							
	Stage Rigger							
	Toxic Haz-Mat Work							
	Welder							

						L&M	IAF	
A1102	Helicopter	41.82	9.51	24.28	0.76	0.20	0.24	76.81
	Helicopter (used for rigging and setting)							
	Tower (energy producing windmill type towers to include nacelle and blades)							

						L&M	IAF	
A1103	Fence/Barrier Installer	37.32	9.51	24.28	0.76	0.20	0.24	72.31

						L&M	IAF	
A1104	Guard Rail Layout Man	38.06	9.51	24.28	0.76	0.20	0.24	73.05

						L&M	IAF	
A1105	Guard Rail Installer	38.32	9.51	24.28	0.76	0.20	0.24	73.31

Laborers (The Alaska areas north of N63 latitude and east of W138 longitude)
 *See per diem note on last page

						L&M	LEG	
N1201	Group I, including:	33.00	8.95	21.16	1.40	0.20	0.20	64.91
	Asphalt Worker (shovelman, plant crew)							
	Brush Cutter							
	Camp Maintenance Laborer							
	Carpenter Tender or Helper							
	Choke Setter, Hook Tender, Rigger, Signalman							
	Concrete Labor (curb & gutter, chute handler, curing, grouting, screeding)							
	Crusher Plant Laborer							
	Demolition Laborer							

Wage benefits key: BHR=basic hourly rate; H&W=health and welfare; IAF=industry advancement fund; LEG=legal fund; L&M=labor/management fund; PEN=pension fund; SAF=safety; SUI=supplemental unemployment insurance; S&L=SUI & LEG combined; TRN=training; THR=total hourly rate; VAC=vacation

Laborers (The Alaska areas north of N63 latitude and east of W138 longitude)
 *See per diem note on last page

						L&M	LEG	
N1201 Group I, including:	33.00	8.95	21.16	1.40	0.20	0.20	64.91	
Ditch Digger								
Dumpman								
Environmental Laborer (hazard/toxic waste, oil spill)								
Fence Installer								
Fire Watch Laborer								
Flagman								
Form Stripper								
General Laborer								
Guardrail Laborer, Bridge Rail Installer								
Hydro-seeder Nozzleman								
Laborer, Building								
Landscaper or Planter								
Laying of Mortarless Decorative Block (retaining walls, flowered decorative block 4 feet or less - highway or landscape work)								
Material Handler								
Pneumatic or Power Tools								
Portable or Chemical Toilet Serviceman								
Pump Man or Mixer Man								
Railroad Track Laborer								
Sandblast, Pot Tender								
Saw Tender								
Slurry Work								
Steam Cleaner Operator								
Steam Point or Water Jet Operator								
Storm Water Pollution Protection Plan Worker (SWPPP Worker - erosion and sediment control Laborer)								
Tank Cleaning								
Utiliwalk & Utilidor Laborer								
Watchman (construction projects)								
Window Cleaner								

						L&M	LEG	
N1202 Group II, including:	34.00	8.95	21.16	1.40	0.20	0.20	65.91	
Burning & Cutting Torch								
Cement or Lime Dumper or Handler (sack or bulk)								
Certified Erosion Sediment Control Lead (CESCL Laborer)								
Choker Splicer								
Chucktender (wagon, air-track & hydraulic drills)								
Concrete Laborer (power buggy, concrete saws, pumpcrete nozzleman, vibratorman)								
Culvert Pipe Laborer								
Cured Inplace Pipelayer								

Wage benefits key: BHR=basic hourly rate; H&W=health and welfare; IAF=industry advancement fund; LEG=legal fund; L&M=labor/management fund; PEN=pension fund; SAF=safety; SUI=supplemental unemployment insurance; S&L=SUI & LEG combined; TRN=training; THR=total hourly rate; VAC=vacation

Laborers (The Alaska areas north of N63 latitude and east of W138 longitude)

*See per diem note on last page

					L&M	LEG	
N1202	Group II, including:	34.00	8.95	21.16	1.40	0.20	0.20 65.91

- Environmental Laborer (asbestos, marine work)
- Floor Preparation, Core Drilling
- Foam Gun or Foam Machine Operator
- Green Cutter (dam work)
- Gunite Operator
- Hod Carrier
- Jackhammer/Chipping Gun or Pavement Breaker
- Laser Instrument Operator
- Laying of Mortarless Decorative Block (retaining walls, flowered decorative block over 4 feet - highway or landscape work)
- Mason Tender & Mud Mixer (sewer work)
- Pilot Car
- Pipelayer Helper
- Plasterer, Bricklayer & Cement Finisher Tender
- Powderman Helper
- Power Saw Operator
- Railroad Switch Layout Laborer
- Sandblaster
- Scaffold Building & Erecting
- Sewer Caulker
- Sewer Plant Maintenance Man
- Thermal Plastic Applicator
- Timber Faller, Chainsaw Operator, Filer
- Timberman

					L&M	LEG	
N1203	Group III, including:	34.90	8.95	21.16	1.40	0.20	0.20 66.81

- Bit Grinder
- Camera/Tool/Video Operator
- Guardrail Machine Operator
- High Rigger & Tree Topper
- High Scaler
- Multiplate
- Plastic Welding
- Slurry Seal Squeegee Man
- Traffic Control Supervisor
- Welding Certified (in connection with laborer's work)

					L&M	LEG	
N1204	Group IIIA	38.18	8.95	21.16	1.40	0.20	0.20 70.09

- Asphalt Raker, Asphalt Belly Dump Lay Down
- Drill Doctor (in the field)

Wage benefits key: BHR=basic hourly rate; H&W=health and welfare; IAF=industry advancement fund; LEG=legal fund; L&M=labor/management fund; PEN=pension fund; SAF=safety; SUI=supplemental unemployment insurance; S&L=SUI & LEG combined; TRN=training; THR=total hourly rate; VAC=vacation

Laborers (The Alaska areas north of N63 latitude and east of W138 longitude)

*See per diem note on last page

						L&M	LEG	
N1204	Group IIIA	38.18	8.95	21.16	1.40	0.20	0.20	70.09

- Driller (including, but not limited to wagon drills, air-track drills, hydraulic drills)
- Pioneer Drilling & Drilling Off Tugger (all type drills)
- Pipelayers
- Powderman (Employee Possessor)
- Storm Water Pollution Protection Plan Specialist (SWPPP Specialist)
- Traffic Control Supervisor, DOT Qualified

						L&M	LEG	
N1205	Group IV	22.57	8.95	21.16	1.40	0.20	0.20	54.48

- Final Building Cleanup
- Permanent Yard Worker

						L&M	LEG	
N1206	Group IIIB	41.97	6.24	21.16	1.40	0.20	0.20	71.17

- Driller (including, but not limited to wagon drills, air-track drills, hydraulic drills)(over 5,000 hours)
- Federal Powderman (Responsible Person in Charge)
- Grade Checking (setting or transferring of grade marks, line and grade, GPS, drones)
- Pioneer Drilling & Drilling Off Tugger (all type drills)(over 5,000 hours)
- Stake Hopper

Laborers (The area that is south of N63 latitude and west of W138 longitude)

*See per diem note on last page

						L&M	LEG	
S1201	Group I, including:	33.00	8.95	21.16	1.40	0.20	0.20	64.91

- Asphalt Worker (shovelman, plant crew)
- Brush Cutter
- Camp Maintenance Laborer
- Carpenter Tender or Helper
- Choke Setter, Hook Tender, Rigger, Signalman
- Concrete Labor (curb & gutter, chute handler, curing, grouting, screeding)
- Crusher Plant Laborer
- Demolition Laborer
- Ditch Digger
- Dumpman
- Environmental Laborer (hazard/toxic waste, oil spill)
- Fence Installer
- Fire Watch Laborer
- Flagman

Wage benefits key: BHR=basic hourly rate; H&W=health and welfare; IAF=industry advancement fund; LEG=legal fund; L&M=labor/management fund; PEN=pension fund; SAF=safety; SUI=supplemental unemployment insurance; S&L=SUI & LEG combined; TRN=training; THR=total hourly rate; VAC=vacation

Laborers (The area that is south of N63 latitude and west of W138 longitude)

*See per diem note on last page

						L&M	LEG	
S1201	Group I, including:	33.00	8.95	21.16	1.40	0.20	0.20	64.91

- Form Stripper
- General Laborer
- Guardrail Laborer, Bridge Rail Installer
- Hydro-seeder Nozzleman
- Laborer, Building
- Landscaper or Planter
- Laying of Mortarless Decorative Block (retaining walls, flowered decorative block 4 feet or less - highway or landscape work)
- Material Handler
- Pneumatic or Power Tools
- Portable or Chemical Toilet Serviceman
- Pump Man or Mixer Man
- Railroad Track Laborer
- Sandblast, Pot Tender
- Saw Tender
- Slurry Work
- Steam Cleaner Operator
- Steam Point or Water Jet Operator
- Storm Water Pollution Protection Plan Worker (SWPPP Worker - erosion and sediment control Laborer)
- Tank Cleaning
- Utiliwalk & Utilidor Laborer
- Watchman (construction projects)
- Window Cleaner

						L&M	LEG	
S1202	Group II, including:	34.00	8.95	21.16	1.40	0.20	0.20	65.91

- Burning & Cutting Torch
- Cement or Lime Dumper or Handler (sack or bulk)
- Certified Erosion Sediment Control Lead (CESCL Laborer)
- Choker Splicer
- Chucktender (wagon, air-track & hydraulic drills)
- Concrete Laborer (power buggy, concrete saws, pumpcrete nozzleman, vibratorman)
- Culvert Pipe Laborer
- Cured Inplace Pipelayer
- Environmental Laborer (asbestos, marine work)
- Floor Preparation, Core Drilling
- Foam Gun or Foam Machine Operator
- Green Cutter (dam work)
- Gunite Operator
- Hod Carrier

Wage benefits key: BHR=basic hourly rate; H&W=health and welfare; IAF=industry advancement fund; LEG=legal fund; L&M=labor/management fund; PEN=pension fund; SAF=safety; SUI=supplemental unemployment insurance; S&L=SUI & LEG combined; TRN=training; THR=total hourly rate; VAC=vacation

Laborers (The area that is south of N63 latitude and west of W138 longitude)
 *See per diem note on last page

S1202	Group II, including:	34.00	8.95	21.16	1.40	L&M	LEG	65.91
--------------	----------------------	-------	------	-------	------	----------------	------------	-------

- Jackhammer/Chipping Gun or Pavement Breaker
- Laser Instrument Operator
- Laying of Mortarless Decorative Block (retaining walls, flowered decorative block over 4 feet - highway or landscape work)
- Mason Tender & Mud Mixer (sewer work)
- Pilot Car
- Pipelayer Helper
- Plasterer, Bricklayer & Cement Finisher Tender
- Powderman Helper
- Power Saw Operator
- Railroad Switch Layout Laborer
- Sandblaster
- Scaffold Building & Erecting
- Sewer Caulker
- Sewer Plant Maintenance Man
- Thermal Plastic Applicator
- Timber Faller, Chainsaw Operator, Filer
- Timberman

S1203	Group III, including:	34.90	8.95	21.16	1.40	L&M	LEG	66.81
--------------	-----------------------	-------	------	-------	------	----------------	------------	-------

- Bit Grinder
- Camera/Tool/Video Operator
- Guardrail Machine Operator
- High Rigger & Tree Topper
- High Scaler
- Multiplate
- Plastic Welding
- Slurry Seal Squeegee Man
- Traffic Control Supervisor
- Welding Certified (in connection with laborer's work)

S1204	Group IIIA	38.18	8.95	21.16	1.40	L&M	LEG	70.09
--------------	------------	-------	------	-------	------	----------------	------------	-------

- Asphalt Raker, Asphalt Belly Dump Lay Down
- Drill Doctor (in the field)
- Driller (including, but not limited to wagon drills, air-track drills, hydraulic drills)
- Pioneer Drilling & Drilling Off Tugger (all type drills)
- Pipelayers
- Powderman (Employee Possessor)
- Storm Water Pollution Protection Plan Specialist (SWPPP Specialist)

Wage benefits key: BHR=basic hourly rate; H&W=health and welfare; IAF=industry advancement fund; LEG=legal fund; L&M=labor/management fund; PEN=pension fund; SAF=safety; SUI=supplemental unemployment insurance; S&L=SUI & LEG combined; TRN=training; THR=total hourly rate; VAC=vacation

Class Code	Classification of Laborers & Mechanics	BHR	H&W	PEN	TRN	Other	Benefits	THR
------------	--	-----	-----	-----	-----	-------	----------	-----

Laborers (The area that is south of N63 latitude and west of W138 longitude)

*See per diem note on last page

S1204	Group IIIA	38.18	8.95	21.16	1.40	L&M	LEG	70.09
	Traffic Control Supervisor, DOT Qualified							
S1205	Group IV	22.57	8.95	21.16	1.40	L&M	LEG	54.48
	Final Building Cleanup Permanent Yard Worker							
S1206	Group IIIB	41.97	6.24	21.16	1.40	L&M	LEG	71.17
	Driller (including, but not limited to wagon drills, air-track drills, hydraulic drills)(over 5,000 hours) Federal Powderman (Responsible Person in Charge) Grade Checking (setting or transferring of grade marks, line and grade, GPS, drones) Pioneer Drilling & Drilling Off Tugger (all type drills)(over 5,000 hours) Stake Hopper							

Millwrights

*See per diem note on last page

A1251	Millwright (journeyman)	44.00	10.08	12.28	1.10	L&M		67.91
A1252	Millwright Welder	45.00	10.08	12.28	1.10	L&M		68.91

Painters, Region I (North of N63 latitude)

*See per diem note on last page

N1301	Group I, including:	34.25	8.85	15.10	1.08	L&M		59.35
	Brush General Painter Hand Taping Hazardous Material Handler Lead-Based Paint Abatement Roll							
N1302	Group II, including:	34.77	8.85	15.10	1.08	L&M		59.87
	Bridge Painter Epoxy Applicator General Drywall Finisher Hand/Spray Texturing Industrial Coatings Specialist							

Wage benefits key: BHR=basic hourly rate; H&W=health and welfare; IAF=industry advancement fund; LEG=legal fund; L&M=labor/management fund; PEN=pension fund; SAF=safety; SUI=supplemental unemployment insurance; S&L=SUI & LEG combined; TRN=training; THR=total hourly rate; VAC=vacation

Painters, Region I (North of N63 latitude)
 *See per diem note on last page

						L&M	
N1302	Group II, including:	34.77	8.85	15.10	1.08	0.07	59.87
	Machine/Automatic Taping						
	Pot Tender						
	Sandblasting						
	Specialty Painter						
	Spray						
	Structural Steel Painter						
	Wallpaper/Vinyl Hanger						

N1304	Group IV, including:	41.16	8.85	18.21	1.05	0.05	69.32
	Glazier						
	Storefront/Automatic Door Mechanic						

N1305	Group V, including:	39.86	8.85	5.00	1.10	0.10	54.91
	Carpet Installer						
	Floor Coverer						
	Heat Weld/Cove Base						
	Linoleum/Soft Tile Installer						

N1306	Group VI, including:	48.17	9.90	5.00	1.10	0.10	64.27
	Traffic Control Striper						

Painters, Region II (South of N63 latitude)
 *See per diem note on last page

						L&M	
S1301	Group I, including :	31.39	8.85	15.95	1.08	0.07	57.34
	Brush						
	General Painter						
	Hand Taping						
	Hazardous Material Handler						
	Lead-Based Paint Abatement						
	Roll						
	Spray						

						L&M	
S1302	Group II, including :	32.64	8.85	15.95	1.08	0.07	58.59
	General Drywall Finisher						
	Hand/Spray Texturing						
	Machine/Automatic Taping						
	Wallpaper/Vinyl Hanger						

Wage benefits key: BHR=basic hourly rate; H&W=health and welfare; IAF=industry advancement fund; LEG=legal fund; L&M=labor/management fund; PEN=pension fund; SAF=safety; SUI=supplemental unemployment insurance; S&L=SUI & LEG combined; TRN=training; THR=total hourly rate; VAC=vacation

Class Code	Classification of Laborers & Mechanics	BHR	H&W	PEN	TRN	Other	Benefits	THR
------------	--	-----	-----	-----	-----	-------	----------	-----

Painters, Region II (South of N63 latitude)
 *See per diem note on last page

S1303	Group III, including :	32.74	8.85	15.95	1.08		L&M 0.07	58.69
--------------	------------------------	-------	------	-------	------	--	------------------------	-------

- Bridge Painter
- Epoxy Applicator
- Industrial Coatings Specialist
- Pot Tender
- Sandblasting
- Specialty Painter
- Structural Steel Painter

S1304	Group IV, including:	41.37	8.85	17.25	1.08		L&M 0.07	68.62
--------------	----------------------	-------	------	-------	------	--	------------------------	-------

- Glazier
- Storefront/Automatic Door Mechanic

S1305	Group V, including:	39.86	8.85	5.00	1.10		L&M 0.10	54.91
--------------	---------------------	-------	------	------	------	--	------------------------	-------

- Carpet Installer
- Floor Coverer
- Heat Weld/Cove Base
- Linoleum/Soft Tile Installer

S1306	Group VI, including:	48.17	9.90	5.00	1.10		0.10	64.27
--------------	----------------------	-------	------	------	------	--	------	-------

- Traffic Control Striper

Piledrivers
 *See per diem note on last page

A1401	Piledriver	42.34	10.08	15.23	1.75		L&M 0.20	IAF 0.20	69.80
--------------	------------	-------	-------	-------	------	--	------------------------	--------------------	-------

- Assistant Dive Tender
- Carpenter/Piledriver
- Rigger
- Sheet Stabber
- Skiff Operator

A1402	Piledriver-Welder/Toxic Worker	43.34	10.08	15.23	1.75		L&M 0.20	IAF 0.20	70.80
--------------	--------------------------------	-------	-------	-------	------	--	------------------------	--------------------	-------

A1403	Remotely Operated Vehicle Pilot/Technician	46.65	10.08	15.23	1.75		L&M 0.20	IAF 0.20	74.11
--------------	--	-------	-------	-------	------	--	------------------------	--------------------	-------

- Single Atmosphere Suit, Bell or Submersible Pilot

A1404	Diver (working) **See note on last page	86.45	10.08	15.23	1.75		L&M 0.20	IAF 0.20	113.91
--------------	---	-------	-------	-------	------	--	------------------------	--------------------	--------

Wage benefits key: BHR=basic hourly rate; H&W=health and welfare; IAF=industry advancement fund; LEG=legal fund; L&M=labor/management fund; PEN=pension fund; SAF=safety; SUI=supplemental unemployment insurance; S&L=SUI & LEG combined; TRN=training; THR=total hourly rate; VAC=vacation

Class Code	Classification of Laborers & Mechanics	BHR	H&W	PEN	TRN	Other	Benefits	THR
------------	--	-----	-----	-----	-----	-------	----------	-----

Piledrivers
*See per diem note on last page

A1405	Diver (standby) **See note on last page	46.65	10.08	15.23	1.75	L&M	IAF	74.11
A1406	Dive Tender **See note on last page	45.65	10.08	15.23	1.75	L&M	IAF	73.11
A1407	Welder (American Welding Society, Certified Welding Inspector)	47.90	10.08	15.23	1.75	L&M	IAF	75.36

Plumbers, Region I (North of N63 latitude)
*See per diem note on last page

N1501	Journeyman Pipefitter	42.91	11.75	17.45	1.50	L&M	S&L	74.26
	Plumber							
	Welder							

Plumbers, Region II (South of N63 latitude)
*See per diem note on last page

S1501	Journeyman Pipefitter	41.00	11.38	15.27	1.55	L&M		69.40
	Plumber							
	Welder							

Plumbers, Region IIA (1st Judicial District)
*See per diem note on last page

X1501	Journeyman Pipefitter	40.82	13.37	11.75	2.50	L&M		68.68
	Plumber							
	Welder							

Power Equipment Operators
*See per diem note on last page

A1601	Group I, including:	43.53	11.05	13.75	1.00	L&M		69.48
	Asphalt Roller: Breakdown, Intermediate, and Finish							
	Back Filler							
	Barrier Machine (Zipper)							
	Belcrete with Power Pack & similar conveyors							
	Bending Machine							
	Boat Coxswain							
	Bulldozer							
	Cableways, Highlines & Cablecars							

Wage benefits key: BHR=basic hourly rate; H&W=health and welfare; IAF=industry advancement fund; LEG=legal fund; L&M=labor/management fund; PEN=pension fund; SAF=safety; SUI=supplemental unemployment insurance; S&L=SUI & LEG combined; TRN=training; THR=total hourly rate; VAC=vacation

Power Equipment Operators

*See per diem note on last page

							L&M		
A1601	Group I, including:	43.53	11.05	13.75	1.00	0.10	0.05	69.48	
	Cleaning Machine								
	Coating Machine								
	Concrete Hydro Blaster								
	Cranes (45 tons & under or 150 feet of boom & under (including jib & attachments))								
	(a) Hydralifts or Transporters, (all track or truck type)								
	(b) Derricks								
	(c) Overhead								
	Crushers								
	Deck Winches, Double Drum								
	Ditching or Trenching Machine (16 inch or over)								
	Drag Scraper, Yarder, and similar types								
	Drilling Machines, Core, Cable, Rotary and Exploration								
	Finishing Machine Operator, Concrete Paving, Laser Screed, Sidewalk, Curb & Gutter Machine								
	Grade Checker and/or Line and Grade including Drone								
	Helicopters								
	Hover Craft, Flex Craft, Loadmaster, Air Cushion, All-Terrain Vehicle, Rollagon, Bargecable, Nodwell, & Snow Cat								
	Hydro Ax, Feller Buncher & similar								
	Hydro Excavation (Vac-Truck and Similar)								
	Loaders (2 1/2 yards through 5 yards, including all attachments):								
	(a) Forklifts (with telescopic boom & swing attachment)								
	(b) Front End & Overhead, (2-1/2 yards through 5 yards)								
	(c) Loaders, (with forks or pipe clamp)								
	(d) Loaders, (elevating belt type, Euclid & similar types)								
	Material Transfer Vehicle (Elevating Grader, Pickup Machine, and similar types)								
	Mechanic, Welder, Bodyman, Electrical, Camp & Maintenance Engineer								
	Micro Tunneling Machine								
	Mixers: Mobile type with hoist combination								
	Motor Patrol Grader								
	Mucking Machine: Mole, Tunnel Drill, Horizontal/Directional Drill Operator and/or Shield								
	Off-Road Hauler (including Articulating and Haul Trucks)								
	Operator on Dredges								
	Piledriver Engineer, L.B. Foster, Puller or similar paving breaker								
	Plant Operator (Asphalt & Concrete)								
	Power Plant, Turbine Operator 200 k.w & over (power plants or combination of power units over 300 k.w.)								
	Remote Controlled Equipment								
	Scraper (through 40 yards)								

Wage benefits key: BHR=basic hourly rate; H&W=health and welfare; IAF=industry advancement fund; LEG=legal fund; L&M=labor/management fund; PEN=pension fund; SAF=safety; SUI=supplemental unemployment insurance; S&L=SUI & LEG combined; TRN=training; THR=total hourly rate; VAC=vacation

Power Equipment Operators
 *See per diem note on last page

		L&M						
A1601	Group I, including:	43.53	11.05	13.75	1.00	0.10	0.05	69.48
	Service Oiler/Service Engineer							
	Shot Blast Machine							
	Shovels, Backhoes, Excavators with all attachments, and Gradealls (3 yards & under)							
	Sideboom (under 45 tons)							
	Sub Grader (Gurries & similar types)							
	Tack Tractor							
	Truck Mounted Concrete Pump, Conveyor/Tele-belt, & Creter							
	Wate Kote Machine							

		L&M						
A1602	Group IA, including:	45.29	11.05	13.75	1.00	0.10	0.05	71.24
	Camera/Tool/Video Operator (Slipline)							
	Certified Welder, Electrical Mechanic, Camp Maintenance Engineer, Mechanic (over 10,000 hours)							
	Cranes (over 45 tons or 150 feet including jib & attachments)							
	(a) Clamshells & Draglines (over 3 yards)							
	(b) Tower Cranes							
	Licensed Water/Waste Water Treatment Operator							
	Loaders (over 5 yards)							
	Motor Patrol Grader, Dozer, Grade Tractor (finish: when finishing to final grade and/or to hubs, or for asphalt)							
	Power Plants (1000 k.w. & over)							
	Profiler, Reclaimer, and Roto-Mill							
	Quad							
	Scrapers (over 40 yards)							
	Screed							
	Shovels, Backhoes, Excavators with all attachments (over 3 yards)							
	Sidebooms (over 45 tons)							
	Slip Form Paver, C.M.I. & similar types							
	Topside (Asphalt Paver, Slurry machine, Spreaders, and similar types)							

		L&M						
A1603	Group II, including:	42.76	11.05	13.75	1.00	0.10	0.05	68.71
	Boiler - Fireman							
	Cement Hogs & Concrete Pump Operator							
	Conveyors (except those listed in Group I)							
	Hoists on Steel Erection, Towermobiles & Air Tuggers							
	Horizontal/Directional Drill Locator							
	Locomotives, Rod & Geared Engines							
	Mixers							
	Screening, Washing Plant							

Wage benefits key: BHR=basic hourly rate; H&W=health and welfare; IAF=industry advancement fund; LEG=legal fund; L&M=labor/management fund; PEN=pension fund; SAF=safety; SUI=supplemental unemployment insurance; S&L=SUI & LEG combined; TRN=training; THR=total hourly rate; VAC=vacation

Power Equipment Operators
 *See per diem note on last page

		L&M						
A1603	Group II, including:	42.76	11.05	13.75	1.00	0.10	0.05	68.71
	Sideboom (cradling rock drill, regardless of size)							
	Skidder							
	Trenching Machines (under 16 inches)							
	Water/Waste Water Treatment Operator							

		L&M						
A1604	Group III, including:	42.04	11.05	13.75	1.00	0.10	0.05	67.99
	"A" Frame Trucks, Deck Winches							
	Bombardier (tack or tow rig)							
	Boring Machine							
	Brooms, Power (sweeper, elevator, vacuum, or similar)							
	Bump Cutter							
	Compressor							
	Farm Tractor							
	Forklift, Industrial Type							
	Gin Truck or Winch Truck (with poles when used for hoisting)							
	Hoists, Air Tuggers, Elevators							
	Loaders:							
	(a) Elevating-Athey, Barber Greene & similar types							
	(b) Forklifts or Lumber Carrier (on construction job sites)							
	(c) Forklifts, (with tower)							
	(d) Overhead & Front End, (under 2-1/2 yards)							
	Locomotives: Dinkey (air, steam, gas & electric) Speeders							
	Mechanics, Light Duty							
	Oil, Blower Distribution							
	Posthole Digger, Mechanical							
	Pot Fireman (power agitated)							
	Power Plant, Turbine Operator, (under 200 k.w.)							
	Pumps, Water							
	Roller (other than Asphalt)							
	Saws, Concrete							
	Skid Hustler							
	Skid Steer (with all attachments)							
	Stake Hopper							
	Straightening Machine							
	Tow Tractor							

		L&M						
A1605	Group IV, including:	35.83	11.05	13.75	1.00	0.10	0.05	61.78
	Crane Assistant Engineer/Rig Oiler							
	Drill Helper							
	Parts & Equipment Coordinator							

Wage benefits key: BHR=basic hourly rate; H&W=health and welfare; IAF=industry advancement fund; LEG=legal fund; L&M=labor/management fund; PEN=pension fund; SAF=safety; SUI=supplemental unemployment insurance; S&L=SUI & LEG combined; TRN=training; THR=total hourly rate; VAC=vacation

Class Code	Classification of Laborers & Mechanics	BHR	H&W	PEN	TRN	Other	Benefits	THR
------------	--	-----	-----	-----	-----	-------	----------	-----

Power Equipment Operators
 *See per diem note on last page

		L&M						
A1605	Group IV, including:	35.83	11.05	13.75	1.00	0.10	0.05	61.78
	Spotter							
	Steam Cleaner							
	Swamper (on trenching machines or shovel type equipment)							

Roofers
 *See per diem note on last page

		L&M						
A1701	Roofer & Waterproofer	44.62	13.75	3.91	0.81	0.10	0.06	63.25

		L&M						
A1702	Roofer Material Handler	31.23	13.75	3.91	0.81	0.10	0.06	49.86

Sheet Metal Workers, Region I (North of N63 latitude)
 *See per diem note on last page

		L&M						
N1801	Sheet Metal Journeyman	49.04	11.85	14.61	1.80	0.12		77.42
	Air Balancing and duct cleaning of HVAC systems							
	Brazing, soldering or welding of metals							
	Demolition of sheet metal HVAC systems							
	Fabrication and installation of exterior wall sheathing, siding, metal roofing, flashing, decking and architectural sheet metal work							
	Fabrication and installation of heating, ventilation and air conditioning ducts and equipment							
	Fabrication and installation of louvers and hoods							
	Fabrication and installation of sheet metal lagging							
	Fabrication and installation of stainless steel commercial or industrial food service equipment							
	Manufacture, fabrication assembly, installation and alteration of all ferrous and nonferrous metal work							
	Metal lavatory partitions							
	Preparation of drawings taken from architectural and engineering plans required for fabrication and erection of sheet metal work							
	Sheet Metal shelving							
	Sheet Metal venting, chimneys and breaching							
	Skylight installation							

Sheet Metal Workers, Region II (South of N63 latitude)
 *See per diem note on last page

		L&M						
S1801	Sheet Metal Journeyman	43.75	11.85	14.39	1.68	0.43		72.10

Air Balancing and duct cleaning of HVAC systems

Wage benefits key: BHR=basic hourly rate; H&W=health and welfare; IAF=industry advancement fund; LEG=legal fund; L&M=labor/management fund; PEN=pension fund; SAF=safety; SUI=supplemental unemployment insurance; S&L=SUI & LEG combined; TRN=training; THR=total hourly rate; VAC=vacation

Sheet Metal Workers, Region II (South of N63 latitude)

*See per diem note on last page

S1801	Sheet Metal Journeyman	43.75	11.85	14.39	1.68		L&M 0.43	72.10
--------------	------------------------	-------	-------	-------	------	--	------------------------	-------

- Brazing, soldering or welding of metals
- Demolition of sheet metal HVAC systems
- Fabrication and installation of exterior wall sheathing, siding, metal roofing, flashing, decking and architectural sheet metal work
- Fabrication and installation of heating, ventilation and air conditioning ducts and equipment
- Fabrication and installation of louvers and hoods
- Fabrication and installation of sheet metal lagging
- Fabrication and installation of stainless steel commercial or industrial food service equipment
- Manufacture, fabrication assembly, installation and alteration of all ferrous and nonferrous metal work
- Metal lavatory partitions
- Preparation of drawings taken from architectural and engineering plans required for fabrication and erection of sheet metal work
- Sheet Metal shelving
- Sheet Metal venting, chimneys and breaching
- Skylight installation

Sprinkler Fitters

*See per diem note on last page

A1901	Sprinkler Fitter	49.10	10.55	18.15	0.52		L&M 0.25	78.57
--------------	------------------	-------	-------	-------	------	--	------------------------	-------

Surveyors

*See per diem note on last page

A2001	Chief of Parties	46.16	12.23	13.64	1.15		L&M 0.10	73.28
--------------	------------------	-------	-------	-------	------	--	------------------------	-------

A2002	Party Chief	44.57	12.23	13.64	1.15		L&M 0.10	71.69
--------------	-------------	-------	-------	-------	------	--	------------------------	-------

A2003	Line & Grade Technician/Office Technician/GPS, Drones	43.97	12.23	13.64	1.15		L&M 0.10	71.09
--------------	---	-------	-------	-------	------	--	------------------------	-------

A2004	Associate Party Chief (including Instrument Person & Head Chain Person)/Stake Hop/Grademan	41.85	12.23	13.64	1.15		L&M 0.10	68.97
--------------	--	-------	-------	-------	------	--	------------------------	-------

A2006	Chain Person (for crews with more than 2 people)	37.51	12.23	13.64	1.15		L&M 0.10	64.63
--------------	--	-------	-------	-------	------	--	------------------------	-------

Wage benefits key: BHR=basic hourly rate; H&W=health and welfare; IAF=industry advancement fund; LEG=legal fund; L&M=labor/management fund; PEN=pension fund; SAF=safety; SUI=supplemental unemployment insurance; S&L=SUI & LEG combined; TRN=training; THR=total hourly rate; VAC=vacation

Truck Drivers

*See per diem note on last page

						L&M	
A2101	Group I, including:	42.94	12.23	13.64	1.15	0.10	70.06

- Air/Sea Traffic Controllers
- Ambulance/Fire Truck Driver (EMT certified)
- Boat Coxswain
- Captains & Pilots (air & water)
- Deltas, Commanders, Rollagons, & similar equipment (when pulling sleds, trailers or similar equipment)
- Dump Trucks (including rockbuggy, side dump, belly dump, & trucks with pups) over 40 yards up to & including 60 yards
- Helicopter Transporter
- Liquid Vac Truck/Super Vac Truck
- Material Coordinator or Purchasing Agent
- Ready-mix (over 12 yards up to & including 15 yards) (over 15 yards to be negotiated)
- Semi with Double Box Mixer
- Tireman, Heavy Duty/Fueler
- Water Wagon (250 Bbls and above)

						L&M	
A2102	Group 1A including:	44.21	12.23	13.64	1.15	0.10	71.33

- Dump Trucks (including rockbuggy, side dump, belly dump & trucks with pups) over 60 yards up to & including 100 yards (over 100 yards to be negotiated)
- Jeeps (driver under load)
- Lowboys, including tractor attached trailers & jeeps, up to & including 12 axles (over 12 axles or 150 tons to be negotiated)

						L&M	
A2103	Group II, including:	41.68	12.23	13.64	1.15	0.10	68.80

- All Deltas, Commanders, Rollagons, & similar equipment
- Batch Trucks (8 yards & up)
- Batch Trucks (up to & including 7 yards)
- Boom Truck/Knuckle Truck (over 5 tons)
- Cacasco Truck/Heat Stress Truck
- Construction and Material Safety Technician
- Dump Trucks (including rockbuggy, side dump, belly dump, & trucks with pups) over 20 yards up to & including 40 yards
- Gin Pole Truck, Winch Truck, Wrecker (truck mounted "A" frame manufactured rating over 5 tons)
- Mechanics
- Oil Distributor Driver
- Partsman
- Ready-mix (up to & including 12 yards)
- Stringing Truck

Wage benefits key: BHR=basic hourly rate; H&W=health and welfare; IAF=industry advancement fund; LEG=legal fund; L&M=labor/management fund; PEN=pension fund; SAF=safety; SUI=supplemental unemployment insurance; S&L=SUI & LEG combined; TRN=training; THR=total hourly rate; VAC=vacation

Truck Drivers
 *See per diem note on last page

A2103	Group II, including:	41.68	12.23	13.64	1.15		L&M 0.10	68.80
--------------	----------------------	-------	-------	-------	------	--	------------------------	-------

Turn-O-Wagon or DW-10 (not self loading)

A2104	Group III, including:	40.86	12.23	13.64	1.15		L&M 0.10	67.98
--------------	-----------------------	-------	-------	-------	------	--	------------------------	-------

- Boom Truck/Knuckle Truck (up to & including 5 tons)
- Dump Trucks (including rockbuggy, side dump, belly dump, & trucks with pups) over 10 yards up to & including 20 yards
- Expeditor (electrical & pipefitting materials)
- Gin Pole Truck, Winch Truck, Wrecker (truck mounted "A" frame manufactured rating 5 tons & under)
- Greaser - Shop
- Semi or Truck & Trailer
- Thermal Plastic Layout Technician
- Traffic Control Technician
- Trucks/Jeeps (push or pull)

A2105	Group IV, including:	40.28	12.23	13.64	1.15		L&M 0.10	67.40
--------------	----------------------	-------	-------	-------	------	--	------------------------	-------

- Air Cushion or similar type vehicle
- All Terrain Vehicle
- Buggymobile
- Bull Lift & Fork Lift, Fork Lift with Power Boom & Swing Attachment (over 5 tons)
- Bus Operator (over 30 passengers)
- Cement Spreader, Dry
- Combination Truck-Fuel & Grease
- Compactor (when pulled by rubber tired equipment)
- Dump Trucks (including rockbuggy, side dump, belly dump, & trucks with pups) up to & including 10 yards
- Dumpster
- Expeditor (general)
- Fire Truck/Ambulance Driver
- Flat Beds, Dual Rear Axle
- Foam Distributor Truck Dual Axle
- Front End Loader with Fork
- Grease Truck
- Hydro Seeder, Dual Axle
- Hyster Operators (handling bulk aggregate)
- Loadmaster (air & water operations)
- Lumber Carrier
- Ready-mix, (up to & including 7 yards)
- Rigger (air/water/oilfield)
- Tireman, Light Duty

Wage benefits key: BHR=basic hourly rate; H&W=health and welfare; IAF=industry advancement fund; LEG=legal fund; L&M=labor/management fund; PEN=pension fund; SAF=safety; SUI=supplemental unemployment insurance; S&L=SUI & LEG combined; TRN=training; THR=total hourly rate; VAC=vacation

Truck Drivers
*See per diem note on last page

A2105 Group IV, including:	40.28	12.23	13.64	1.15		L&M	0.10	67.40
Track Truck Equipment								
Truck Vacuum Sweeper								
Warehouseperson								
Water Truck (Below 250 Bbls)								
Water Truck (straight)								
Water Wagon, Semi								

A2106 Group V, including:	39.52	12.23	13.64	1.15		L&M	0.10	66.64
Buffer Truck								
Bull Lifts & Fork Lifts, Fork Lifts with Power Boom & Swing Attachments (up to & including 5 tons)								
Bus Operator (up to 30 passengers)								
Farm Type Rubber Tired Tractor (when material handling or pulling wagons on a construction project)								
Flat Beds, Single Rear Axle								
Foam Distributor Truck Single Axle								
Fuel Handler (station/bulk attendant)								
Gear/Supply Truck								
Gravel Spreader Box Operator on Truck								
Hydro Seeders, Single axle								
Pickups (pilot cars & all light-duty vehicles)								
Rigger/Swamper								
Tack Truck								
Team Drivers (horses, mules, & similar equipment)								

Tunnel Workers, Laborers (The Alaska areas north of N63 latitude and east of W138 longitude)
*See per diem note on last page

N2201 Group I, including:	36.30	8.95	21.16	1.40		L&M	LEG	68.21
Brakeman								
Mucker								
Nipper								
Storm Water Pollution Protection Plan Worker (SWPPP Worker - erosion and sediment control Laborer)								
Topman & Bull Gang								
Tunnel Track Laborer								

N2202 Group II, including:	37.40	8.95	21.16	1.40		L&M	LEG	69.31
Burning & Cutting Torch								
Certified Erosion Sediment Control Lead (CESCL Laborer)								

Wage benefits key: BHR=basic hourly rate; H&W=health and welfare; IAF=industry advancement fund; LEG=legal fund; L&M=labor/management fund; PEN=pension fund; SAF=safety; SUI=supplemental unemployment insurance; S&L=SUI & LEG combined; TRN=training; THR=total hourly rate; VAC=vacation

Tunnel Workers, Laborers (The Alaska areas north of N63 latitude and east of W138 longitude)
 *See per diem note on last page

N2202 Group II, including:	37.40	8.95	21.16	1.40		L&M	LEG	69.31
-----------------------------------	-------	------	-------	------	--	----------------	------------	-------

- Concrete Laborer
- Floor Preparation, Core Drilling
- Jackhammer/Chipping Gun or Pavement Breaker
- Laser Instrument Operator
- Nozzle men, Pumpcrete or Shotcrete
- Pipelayer Helper

N2203 Group III, including:	38.39	8.95	21.16	1.40		L&M	LEG	70.30
------------------------------------	-------	------	-------	------	--	----------------	------------	-------

- Miner
- Retimberman

N2204 Group IIIA, including:	42.00	8.95	21.16	1.40		L&M	LEG	73.91
-------------------------------------	-------	------	-------	------	--	----------------	------------	-------

- Asphalt Raker, Asphalt Belly Dump Lay Down
- Drill Doctor (in the field)
- Driller (including, but not limited to wagon drills, air-track drills, hydraulic drills)
- Pioneer Drilling & Drilling Off Tugger (all type drills)
- Pipelayer
- Powderman (Employee Possessor)
- Storm Water Pollution Protection Plan Specialist (SWPPP Specialist)
- Traffic Control Supervisor, DOT Qualified

N2206 Group IIIB, including:	46.17	6.24	21.16	1.40		L&M	LEG	75.37
-------------------------------------	-------	------	-------	------	--	----------------	------------	-------

- Driller (including, but not limited to wagon drills, air-track drills, hydraulic drills)(over 5,000 hours)
- Federal Powderman (Responsible Person in Charge)
- Grade Checking (setting or transferring of grade marks, line and grade, GPS, drones)
- Pioneer Drilling & Drilling Off Tugger (all type drills)(over 5,000 hours)
- Stake Hopper

Tunnel Workers, Laborers (The area that is south of N63 latitude and west of W138 longitude)
 *See per diem note on last page

S2201 Group I, including:	36.30	8.95	21.16	1.40		L&M	LEG	68.21
----------------------------------	-------	------	-------	------	--	----------------	------------	-------

- Brakeman
- Mucker
- Nipper
- Storm Water Pollution Protection Plan Worker (SWPPP Worker - erosion and sediment control Laborer)

Wage benefits key: BHR=basic hourly rate; H&W=health and welfare; IAF=industry advancement fund; LEG=legal fund; L&M=labor/management fund; PEN=pension fund; SAF=safety; SUI=supplemental unemployment insurance; S&L=SUI & LEG combined; TRN=training; THR=total hourly rate; VAC=vacation

Tunnel Workers, Laborers (The area that is south of N63 latitude and west of W138 longitude)
 *See per diem note on last page

S2201	Group I, including:	36.30	8.95	21.16	1.40	0.20	0.20	68.21
	Topman & Bull Gang							
	Tunnel Track Laborer							

S2202	Group II, including:	37.40	8.95	21.16	1.40	0.20	0.20	69.31
	Burning & Cutting Torch							
	Certified Erosion Sediment Control Lead (CESCL Laborer)							
	Concrete Laborer							
	Floor Preparation, Core Drilling							
	Jackhammer/Chipping Gun or Pavement Breaker							
	Laser Instrument Operator							
	Nozzlemen, Pumpcrete or Shotcrete							
	Pipelayer Helper							

S2203	Group III, including:	38.39	8.95	21.16	1.40	0.20	0.20	70.30
	Miner							
	Retimberman							

S2204	Group IIIA, including:	42.00	8.95	21.16	1.40	0.20	0.20	73.91
	Asphalt Raker, Asphalt Belly Dump Lay Down							
	Drill Doctor (in the field)							
	Driller (including, but not limited to wagon drills, air-track drills, hydraulic drills)							
	Pioneer Drilling & Drilling Off Tugger (all type drills)							
	Pipelayer							
	Powderman (Employee Possessor)							
	Storm Water Pollution Protection Plan Specialist (SWPPP Specialist)							
	Traffic Control Supervisor, DOT Qualified							

S2206	Group IIIB, including:	46.17	6.24	21.16	1.40	0.20	0.20	75.37
	Driller (including, but not limited to wagon drills, air-track drills, hydraulic drills)(over 5,000 hours)							
	Federal Powderman (Responsible Person in Charge)							
	Grade Checking (setting or transferring of grade marks, line and grade, GPS, drones)							
	Pioneer Drilling & Drilling Off Tugger (all type drills)(over 5,000 hours)							
	Stake Hopper							

Tunnel Workers, Power Equipment Operators
 *See per diem note on last page

Wage benefits key: BHR=basic hourly rate; H&W=health and welfare; IAF=industry advancement fund; LEG=legal fund; L&M=labor/management fund; PEN=pension fund; SAF=safety; SUI=supplemental unemployment insurance; S&L=SUI & LEG combined; TRN=training; THR=total hourly rate; VAC=vacation

Class Code	Classification of Laborers & Mechanics	BHR	H&W	PEN	TRN	Other	Benefits	THR
------------	--	-----	-----	-----	-----	-------	----------	-----

Tunnel Workers, Power Equipment Operators

*See per diem note on last page

A2207	Group I	47.88	11.05	13.75	1.00	L&M	0.10	0.05	73.83
A2208	Group IA	49.82	11.05	13.75	1.00	L&M	0.10	0.05	75.77
A2209	Group II	47.04	11.05	13.75	1.00	L&M	0.10	0.05	72.99
A2210	Group III	46.24	11.05	13.75	1.00	L&M	0.10	0.05	72.19
A2211	Group IV	39.41	11.05	13.75	1.00	L&M	0.10	0.05	65.36

* Per diem is an established practice for this classification. This means that per diem is an allowable alternative to board and lodging if all criteria are met. See 8 AAC 30.051-08 AAC 30.056, and the per diem information on page vii of this Pamphlet.

** Work in combination of classifications: Employees working in any combination of classifications within the diving crew (working diver, standby diver, and tender) in a shift are paid in the classification with the highest rate for a minimum of 8 hours per shift.

Wage benefits key: BHR=basic hourly rate; H&W=health and welfare; IAF=industry advancement fund; LEG=legal fund; L&M=labor/management fund; PEN=pension fund; SAF=safety; SUI=supplemental unemployment insurance; S&L=SUI & LEG combined; TRN=training; THR=total hourly rate; VAC=vacation

- This page intentionally left blank -

Shipyard Rates Addendum

This Addendum was developed to address the specialized industry of shipbuilding/repair in Alaska, as it relates to public works. For the purposes of providing rates for shipyard work the Department is adopting Shipyard rates from the state of Washington (King County). These rates only apply to work done in shipbuilding/repair in Alaska, under a public contract. This addendum will be updated two times a year to coincide with the corresponding Issue of *Laborers and Mechanics MINIMUM RATES OF PAY*.

Class Code	BHR H&W PEN TRN Other Benefits	THR
Shipyard Workers *See total hourly(THR) note below		
A2300	Ship Building/Repair Boilermaker	47.45
A2305	Ship Building/Repair Carpenter	47.35
A2310	Ship Building/Repair Crane Operator	45.06
A2315	Ship Building/Repair Electrician	48.92
A2320	Ship Building/Repair Heat & Frost Insulator	82.02
A2325	Ship Building/Repair Laborer	47.35
A2330	Ship Building/Repair Mechanist	47.35
A2335	Ship Building/Repair Operating Engineer	45.06
A2340	Ship Building/Repair Painter	47.35
A2345	Ship Building/Repair Pipefitter	47.35
A2350	Ship Building/Repair Rigger	47.45
A2355	Ship Building/Repair Sheet Metal	47.35
A2360	Ship Building/Repair Shipwright	47.35
A2365	Ship Building/Repair Warehouse	45.06

*The THR includes the base hourly rate (BHR) and fringe benefits. Employers must pay a BHR and fringe benefit package that adds up to the THR. Fringe benefits included in the THR can be paid to employees in three ways; paid into a union trust fund, into an approved benefit plan, or paid directly on the paycheck as gross wages.

Wage benefits key: BHR=basic hourly rate; H&W=health and welfare; IAF=industry advancement fund; LEG=legal fund; L&M=labor/management fund; PEN=pension fund; SAF=safety; SUI=supplemental unemployment insurance; S&L=SUI & LEG combined; TRN=training; THR=total hourly rate; VAC=vacation

SECTION 011000 - SUMMARY

PART 1 - GENERAL

1.1 RELATED DOCUMENTS

- A. Drawings and general provisions of the Contract, including General and Supplementary Conditions and other Division 01 Specification Sections, apply to this Section.

1.2 SUMMARY

- A. Section Includes:

- 1. Project information.
- 2. Work covered by Contract Documents.
- 3. Check that 000300 identified Substantial Completion and Final Completion
- 4. Access to site.
- 5. Coordination with occupants.
- 6. Work restrictions.
- 7. Specification and drawing conventions.
- 8. Miscellaneous Provisions.

- B. Related Requirements:

- 1. Section 015000 "Temporary Facilities and Controls" for limitations and procedures governing temporary use of Owner's facilities.

1.3 PROJECT INFORMATION

- A. Project Identification: BRH CT & MRI Replacement, CBJ Contract No. BE 23-042.

- 1. Project Location:
 - a. 3260 Hospital Drive, Juneau AK

- B. Owner: City and Borough of Juneau.

- 1. Owner's Representative: Russell G Shivers, CBJ Project Manager, rusty.shivers@juneau.org, Work phone: (907) 586-0800 x4183.
- 2. Using Agency: Bartlett Regional Hospital
- 3. Using Agency Representative: Marc Walker, BRH Facilities Manager, mwalker@bartlethospital.org, Work phone: (907) 796-8888

- C. Architect/Engineer: Ann Byker, Architects Alaska, 900 W. 5th Avenue, Suite 403, Anchorage, Alaska 99501-2029, AByker@architectsalaska.com, Work phone: (907) 272-3567

SECTION 011000 - SUMMARY

1.4 WORK COVERED BY CONTRACT DOCUMENTS

- A. The Work of Project is defined by the Contract Documents and consists of the following:

Project consists of the Work required to facilitate the replacement of three (3) medical imaging modalities including two (2) CT scanners and one (1) MRI. This Work includes the addition of new chiller to cool the equipment, equipment screen, replacement of interior finishes as necessary, and the necessary infrastructure to support a temporary MRI trailer during construction operations.

There are no modifications proposed to egress, construction classification, use, occupancy, building area, or rated assemblies.

The Contractor, as a delegated design, shall address the fire alarm system, automatic sprinkler system, RF shielding, and Magnetic shielding requirements utilizing the reference report documents in Appendix A.

The Work shall be phased; See Sheet D101 and A101 in The Drawings.

- B. Type of Contract:

1. Project will be constructed under a single prime contract.

1.5 ACCESS TO SITE

- A. General: Contractor shall have limited use of Project site for construction operations as indicated on Drawings by the Contract limits and as indicated by requirements of this Section.

- B. Use of Site: Limit use of premises to work areas and areas within the Contract limits indicated. Do not disturb portions of premises beyond areas in which the Work is indicated.

1. Contractor Staging Area and construction area: Owner shall make a portion of the work area available to the Contractor for material storage and parking as shown on the Drawings.
2. Driveways, Walkways and Entrances: Keep driveways loading areas, and entrances serving premises clear and available to Users, Owner, Owner's employees and emergency vehicles at all times.
3. Owner Occupancy: Allow for limited Owner occupancy of the premises during construction.
4. Construction Debris: Construction debris shall be stored in dumpster or similar container when stored on the premises.

- C. Condition of Existing Building: Maintain portions of existing building affected by construction operations in a weather-tight condition throughout construction period. Repair damage caused by construction operations.

SECTION 011000 - SUMMARY

- D. Site Security: The Contractor shall be responsible for building security and protecting the site from theft, vandalism, and unauthorized entry during the construction period.

1.6 COORDINATION WITH OCCUPANTS

- A. Full Owner Occupancy: Owner will occupy the site and adjacent existing structures during the construction period, with the exception of areas under construction. Cooperate with Owner during construction operations to minimize conflicts and facilitate Owner usage. Perform the Work so as not to interfere with Owner's operations. This section will outline personnel immunization requirements, restrictions within active construction areas, and implementation of infection control measures within applicable areas.
 - 1. Provide not less than 72 normal business hours, notice to Owner of activities that will affect Owner's operations.
- B. Special Safety Requirements: The Contractor shall comply with requirements in Section 015221A "Special Safety Requirements". To ensure Project and campus wide safety, the Contractor shall carefully adhere to the requirements outlined within this section and within any attached BRH policies.
- C. Infection Control Risk Assessment: The Contractor shall comply with requirements in Section 015221B "ICRA Infection Control For Construction and Renovation". These guidelines apply identification and reduction of risk from airborne transmission of infections agents during construction, demolition, renovation, and repair on the Bartlett Regional Hospital Campus.

1.7 WORK RESTRICTIONS

- A. Work Restrictions, General: Comply with limitations on use of public streets and with other requirements of authorities having jurisdiction.
- B. On-Site Work Hours: Limit work in the existing building to normal business working hours of 7:00 a.m. to 5:00 p.m., Monday through Friday, unless otherwise indicated or specifically approved by Owner. Work performed outside of normal business hours may be preferable to the Owner under certain circumstances but prior approval shall be required.
- C. Existing Utility Interruptions: Do not interrupt utilities serving facilities occupied by Owner or others unless permitted under the following conditions and then only after providing temporary utility services according to requirements indicated:
 - 1. Notify Owner not less than 72 hours in advance of proposed utility interruptions.
 - 2. Obtain Owner's written permission before proceeding with utility interruptions.
- D. Controlled Substances: Use of tobacco products and controlled substances on Project site is not permitted.

SECTION 011000 - SUMMARY

1.8 SPECIFICATION AND DRAWING CONVENTIONS

- A. Specification Content: The Specifications use certain conventions for the style of language and the intended meaning of certain terms, words, and phrases when used in particular situations. These conventions are as follows:
 - 1. Imperative mood and streamlined language are generally used in the Specifications. The words "shall," "shall be," or "shall comply with," depending on the context, are implied where a colon (:) is used within a sentence or phrase.
 - 2. Specification requirements are to be performed by Contractor unless specifically stated otherwise.
- B. Division 01 General Requirements: Requirements of Sections in Division 01 apply to the Work of all Sections in the Specifications.
- C. Drawing Coordination: Requirements for materials and products identified on Drawings are described in detail in the Specifications. One or more of the following are used on Drawings to identify materials and products:
 - 1. Terminology: Materials and products are identified by the typical generic terms used in the individual Specifications Sections.

1.9 MISCELLANEOUS PROVISIONS

- A. All references in specifications to Engineer and Architect shall be facilitated and coordinated with the CBJ Project Manager.
- B. All references in the specifications to Owner or Owner's representative shall mean CBJ Project Manager.

PART 2 - PRODUCTS (Not Used)

PART 3 - EXECUTION (Not Used)

END OF SECTION

SECTION 012300 - ALTERNATES

PART 1 - GENERAL

1.1 RELATED DOCUMENTS

- A. Drawings and general provisions of the Contract, including General and Supplementary Conditions and other Division 01 Specification Sections, apply to this Section.

1.2 SUMMARY

- A. Section includes administrative and procedural requirements for alternates.

1.3 DEFINITIONS

- A. Alternate: An amount proposed by bidders and stated on the Bid Form for certain work defined in the bidding requirements that may be added to or deducted from the base bid amount if Owner decides to accept a corresponding change either in the amount of construction to be completed or in the products, materials, equipment, systems, or installation methods described in the Contract Documents.
 - 1. Alternates described in this Section are part of the Work only if enumerated in the Agreement.
 - 2. The cost or credit for each alternate is the net addition to or deduction from the Contract Sum to incorporate alternate into the Work. No other adjustments are made to the Contract Sum.

1.4 PROCEDURES

- A. All alternates will be Additive Alternates.
- B. Coordination: Revise or adjust affected adjacent work as necessary to completely integrate work of the alternate into Project.
 - 1. Include as part of each alternate, miscellaneous devices, accessory objects, and similar items incidental to or required for a complete installation whether or not indicated as part of alternate.
- C. Notification: Immediately following award of the Contract, notify each party involved, in writing, of the status of each alternate. Indicate if alternates have been accepted, rejected, or deferred for later consideration. Include a complete description of negotiated revisions to alternates.
- D. Execute accepted alternates under the same conditions as other work of the Contract.
- E. Schedule: A schedule of alternates is included at the end of this Section. Specification Sections referenced in schedule contain requirements for materials necessary to achieve the work described under each alternate.

SECTION 012300 - ALTERNATES

PART 2 - PRODUCTS (Not Used)

PART 3 - EXECUTION

3.1 SCHEDULE OF ADDITIVE ALTERNATES

A. Alternate No. 1: Alternate Reflected Ceiling Plan

- 1. Provide new acoustical ceiling tile and grid, new lighting, and new mechanical grilles in rooms 1314A, 1314B, 1364, 1361, and 1358.**

END OF SECTION

SECTION 012500 - SUBSTITUTION PROCEDURES

PART 1 - GENERAL

1.1 RELATED DOCUMENTS

- A. Drawings and general provisions of the Contract, including General and Supplementary Conditions and other Division 01 Specification Sections, apply to this Section.

1.2 SUMMARY

- A. Section includes administrative and procedural requirements for substitutions.
- B. Related Requirements:
 - 1. Section 016000 "Product Requirements" for requirements for submitting comparable product submittals for products by listed manufacturers.

1.3 DEFINITIONS

- A. Substitutions: Changes in products, materials, equipment, and methods of construction from those required by the Contract Documents and proposed by Contractor.
 - 1. Substitutions for Cause: Changes proposed by Contractor that are required due to changed Project conditions, such as unavailability of product, regulatory changes, or unavailability of required warranty terms.
 - 2. Substitutions for Convenience: Changes proposed by Contractor or Owner that are not required in order to meet other Project requirements but may offer advantage to Contractor or Owner.

1.4 ACTION SUBMITTALS

- A. Substitution Requests: Submit three copies of each request for consideration. Identify product or fabrication or installation method to be replaced. Include Specification Section number and title and Drawing numbers and titles.
 - 1. Substitution Request Form: Use CSI Form 13.1A or a similar form
 - 2. Documentation: Show compliance with requirements for substitutions and the following, as applicable:
 - a. Statement indicating why specified product or fabrication or installation cannot be provided.
 - b. Coordination information, including a list of changes or revisions needed to other parts of the Work and to construction performed by Owner and separate contractors that will be necessary to accommodate proposed substitution.

SECTION 012500 - SUBSTITUTION PROCEDURES

- c. Detailed comparison of significant qualities of proposed substitution with those of the Work specified. Include annotated copy of applicable Specification Section. Significant qualities may include attributes such as performance, weight, size, durability, visual effect, sustainable design characteristics, warranties, and specific features and requirements indicated. Indicate deviations, if any, from the Work specified.
 - d. Product Data, including drawings and descriptions of products and fabrication and installation procedures.
 - e. Samples, where applicable or requested.
 - f. Certificates and qualification data, where applicable or requested.
 - g. List of similar installations for completed projects with project names and addresses and names and addresses of architects and owners.
 - h. Material test reports from a qualified testing agency indicating and interpreting test results for compliance with requirements indicated.
 - i. Research reports evidencing compliance with building code in effect for Project, from ICC-ES.
 - j. Detailed comparison of Contractor's construction schedule using proposed substitution with products specified for the Work, including effect on the overall Contract Time. If specified product or method of construction cannot be provided within the Contract Time, include letter from manufacturer, on manufacturer's letterhead, stating date of receipt of purchase order, lack of availability, or delays in delivery.
 - k. Cost information, including a proposal of change, if any, in the Contract Sum.
 - l. Contractor's certification that proposed substitution complies with requirements in the Contract Documents except as indicated in substitution request, is compatible with related materials, and is appropriate for applications indicated.
 - m. Contractor's waiver of rights to additional payment or time that may subsequently become necessary because of failure of proposed substitution to produce indicated results.
3. Architect's Action: If necessary, Architect will request additional information or documentation for evaluation within seven days of receipt of a request for substitution. Architect will notify Contractor of acceptance or rejection of proposed substitution within 7 days of receipt of request, or seven days of receipt of additional information or documentation, whichever is later.
 - a. Forms of Acceptance: Change Order, Construction Change Directive, or Architect's Supplemental Instructions for minor changes in the Work.
 - b. Use product specified if Architect does not issue a decision on use of a proposed substitution within time allocated.

1.5 QUALITY ASSURANCE

- A. Compatibility of Substitutions: Investigate and document compatibility of proposed substitution with related products and materials. Engage a qualified testing agency to perform compatibility tests recommended by manufacturers.

SECTION 012500 - SUBSTITUTION PROCEDURES

1.6 PROCEDURES

- A. Coordination: Revise or adjust affected work as necessary to integrate work of the approved substitutions.

PART 2 - PRODUCTS

2.1 SUBSTITUTIONS

- A. Substitutions for Cause: Submit requests for substitution immediately on discovery of need for change, but not later than 15 days prior to time required for preparation and review of related submittals.

- 1. Conditions: Architect will consider Contractor's request for substitution when the following conditions are satisfied. If the following conditions are not satisfied, Architect will return requests without action, except to record noncompliance with these requirements:

- a. Requested substitution is consistent with the Contract Documents and will produce indicated results.
- b. Substitution request is fully documented and properly submitted.
- c. Requested substitution will not adversely affect Contractor's construction schedule.
- d. Requested substitution has received necessary approvals of authorities having jurisdiction.
- e. Requested substitution is compatible with other portions of the Work.
- f. Requested substitution has been coordinated with other portions of the Work.
- g. Requested substitution provides specified warranty.
- h. If requested substitution involves more than one contractor, requested substitution has been coordinated with other portions of the Work, is uniform and consistent, is compatible with other products, and is acceptable to all contractors involved.

- B. Substitutions for Convenience: Architect will consider requests for substitution if received within 30 days after the Notice to Proceed. Requests received after that time will not be considered.

- 1. Conditions: Architect will consider Contractor's request for substitution when the following conditions are satisfied. If the following conditions are not satisfied, Architect will return requests without action, except to record noncompliance with these requirements:

- a. Requested substitution offers Owner a substantial advantage in cost, time, energy conservation, or other considerations, after deducting additional responsibilities Owner must assume. Owner's additional responsibilities may include compensation to Architect for redesign and evaluation services, increased cost of other construction by Owner, and similar considerations.
- b. Requested substitution does not require extensive revisions to the Contract Documents.
- c. Requested substitution is consistent with the Contract Documents and will produce indicated results.

SECTION 012500 - SUBSTITUTION PROCEDURES

- d. Substitution request is fully documented and properly submitted.
- e. Requested substitution will not adversely affect Contractor's construction schedule.
- f. Requested substitution has received necessary approvals of authorities having jurisdiction.
- g. Requested substitution is compatible with other portions of the Work.
- h. Requested substitution has been coordinated with other portions of the Work.
- i. Requested substitution provides specified warranty.
- j. If requested substitution involves more than one contractor, requested substitution has been coordinated with other portions of the Work, is uniform and consistent, is compatible with other products, and is acceptable to all contractors involved.

PART 3 - EXECUTION (Not Used)

END OF SECTION

SECTION 012600 - CONTRACT MODIFICATION PROCEDURES

PART 1 - GENERAL

1.1 RELATED DOCUMENTS

- A. Drawings and general provisions of the Contract, including General and Supplementary Conditions and other Division 01 Specification Sections, apply to this Section.

1.2 SUMMARY

- A. Section includes administrative and procedural requirements for handling and processing Contract modifications.
- B. Related Requirements:
 - 1. Section 012500 "Substitution Procedures" for administrative procedures for handling requests for substitutions made after the Contract award.
- C. Contractor fees shall not exceed fees defined in Section 00700 General Conditions, Article 11.4 Contractor Fees.

1.3 PROPOSAL REQUESTS

- A. Owner-Initiated Proposal Requests: Owner's Representative will issue a detailed description of proposed changes in the Work that may require adjustment to the Contract Sum or the Contract Time. If necessary, the description will include supplemental or revised Drawings and Specifications.
 - 1. Work Change Proposal Requests issued, are not instructions either to stop work in progress or to execute the proposed change.
 - 2. Within time specified in Proposal Request or 10 days, when not otherwise specified, after receipt of Proposal Request, submit a quotation estimating cost adjustments to the Contract Sum and the Contract Time necessary to execute the change.
 - a. Include a list of quantities of products required or eliminated and unit costs, with total amount of purchases and credits to be made. If requested, furnish survey data to substantiate quantities.
 - b. Indicate applicable taxes, delivery charges, equipment rental, and amounts of trade discounts.
 - c. Include costs of labor and supervision directly attributable to the change.
 - d. Include an updated Contractor's construction schedule that indicates the effect of the change, including, but not limited to, changes in activity duration, start and finish times, and activity relationship. Use available total float before requesting an extension of the Contract Time.
 - e. Quotation Form: Use forms acceptable to Architect.
- B. Contractor-Initiated Proposals: If latent or changed conditions require modifications to the Contract, Contractor may initiate a claim by submitting a request for a change to Owner's Representative.

SECTION 012600 - CONTRACT MODIFICATION PROCEDURES

1. Include a statement outlining reasons for the change and the effect of the change on the Work. Provide a complete description of the proposed change. Indicate the effect of the proposed change on the Contract Sum and the Contract Time.
2. Include a list of quantities of products required or eliminated and unit costs, with total amount of purchases and credits to be made. If requested, furnish survey data to substantiate quantities.
3. Indicate applicable taxes, delivery charges, equipment rental, and amounts of trade discounts.
4. Include costs of labor and supervision directly attributable to the change.
5. Include an updated Contractor's construction schedule that indicates the effect of the change, including, but not limited to, changes in activity duration, start and finish times, and activity relationship. Use available total float before requesting an extension of the Contract Time.
6. Comply with requirements in Section 012500 "Substitution Procedures" if the proposed change requires substitution of one product or system for product or system specified.
7. Proposal Request Form: Use form acceptable to Architect.

1.4 CHANGE ORDER PROCEDURES

- A. On Owner's approval of a Work Changes Proposal Request, Owner's Representative will issue a Change Order for signatures of Owner and Contractor.
- B. Owner will group approved Work Changes into a formal Change Order every three months for formal inclusion into the Construction Agreement.

1.5 CONSTRUCTION CHANGE DIRECTIVE

- A. Construction Change Directive: Owner's Representative may issue a Construction Change Directive on AIA Document G714 or a similar form. Construction Change Directive instructs Contractor to proceed with a change in the Work, for subsequent inclusion in a Change Order.
 1. Construction Change Directive contains a complete description of change in the Work. It also designates method to be followed to determine change in the Contract Sum or the Contract Time.
- B. Documentation: Maintain detailed records on a time and material basis of work required by the Construction Change Directive.
 1. After completion of change, submit an itemized account and supporting data necessary to substantiate cost and time adjustments to the Contract.

PART 2 - PRODUCTS (Not Used)

PART 3 - EXECUTION (Not Used)

END OF SECTION

SECTION 012900 – PAYMENT PROCEDURES

PART 1 - GENERAL

1.1 SCHEDULE OF VALUES

- A. Coordination: Coordinate preparation of the schedule of values with preparation of Contractor's construction schedule.
1. Coordinate line items in the schedule of values with other required administrative forms and schedules, including the following:
 - a. Application for Payment forms with continuation sheets.
 - b. Submittal schedule.
 - c. Items required to be indicated as separate activities in Contractor's construction schedule.
 2. Submit the schedule of values to Architect at earliest possible date, but no later than 14 days before the date scheduled for submittal of initial Applications for Payment.
- B. Format and Content: Use Project Manual table of contents as a guide to establish line items for the schedule of values. Provide at least one line item for each Specification Section.
1. Identification: Include the following Project identification on the schedule of values:
 - a. Project name and location.
 - b. Name of Architect.
 - c. Architect's project number.
 - d. Contractor's name and address.
 - e. Date of submittal.
 2. Arrange the schedule of values in tabular form with separate columns to indicate the following for each item listed:
 - a. Related Specification Section or Division.
 - b. Description of the Work.
 - c. Name of subcontractor, manufacturer, fabricator, or supplier.
 - d. Change Orders (numbers) that affect value.
 - e. Dollar value of the following, as a percentage of the Contract Sum to nearest one-hundredth percent, adjusted to total 100 percent.
 - 1) Labor.
 - 2) Materials.
 - 3) Equipment.
 3. Provide a breakdown of the Contract Sum in enough detail to facilitate continued evaluation of Applications for Payment and progress reports. Coordinate with Project Manual table of contents.
 4. Round amounts to nearest whole dollar; total shall equal the Contract Sum.

SECTION 012900 – PAYMENT PROCEDURES

5. Provide a separate line item in the schedule of values for each part of the Work where Applications for Payment may include materials or equipment purchased or fabricated and stored, but not yet installed.
 - a. Differentiate between items stored on-site and items stored off-site. If required, include evidence of insurance.
 6. Each item in the schedule of values and Applications for Payment shall be complete. Include total cost and proportionate share of general overhead and profit for each item.
 - a. Temporary facilities and other major cost items that are not direct cost of actual work-in-place may be shown either as separate line items in the schedule of values or distributed as general overhead expense, at Contractor's option.
 7. Schedule Updating: Update and resubmit the schedule of values before the next Applications for Payment when Change Orders or Construction Change Directives result in a change in the Contract Sum.
- C. Final Payment – Submit final Application for Payment in conjunction with other closeout documentation as noted in SECTION 017700 “Closeout Procedures”. Final payment shall be for no less than 5% of the contract total and will be released when all closeout documentation and actions are complete.

1.2 APPLICATION AND CERTIFICATION FOR PAYMENT

- A. Format and Content: Use AIA G702 Application and Certificate for Payment or equal.

PART 2 – PRODUCTS (Not Used)

PART 3 – EXECUTION (Not Used)

END OF SECTION

SECTION 013100 - PROJECT MANAGEMENT AND COORDINATION

PART 1 - GENERAL

1.1 RELATED DOCUMENTS

- A. Drawings and general provisions of the Contract, including General and Supplementary Conditions and other Division 01 Specification Sections, apply to this Section.

1.2 SUMMARY

- A. Section includes administrative provisions for coordinating construction operations on Project including, but not limited to, the following:
 - 1. Informational Submittals.
 - 2. General coordination procedures.
 - 3. Requests for Information (RFIs).
 - 4. Design clarifications (DC's)
 - 5. Project meetings.
 - 6. Project Management Software
- B. Each contractor shall participate in coordination requirements. Certain areas of responsibility are assigned to a specific contractor.
- C. Related Requirements:
 - 1. Section 013200 "Construction Progress Documentation" for preparing and submitting Contractor's construction schedule.
 - 2. Section 017300 "Execution" for procedures for coordinating general installation and field-engineering services, including establishment of benchmarks and control points.
 - 3. Section 017700 "Closeout Procedures" for coordinating closeout of the Contract.

1.3 DEFINITIONS

- A. RFI: Request from Owner, Architect, or Contractor seeking information required by or clarifications of the Contract Documents.
- B. DC: Document issued by Design team providing clarification of design intent or interpretation of the Contract Documents.

1.4 INFORMATIONAL SUBMITTALS

- A. Subcontract List: Prepare a written summary identifying individuals or firms proposed for each portion of the Work, including those who are to furnish products or equipment fabricated to a special design. Include the following information in tabular form:
 - 1. Name, address, and telephone number of entity performing subcontract or supplying products.

SECTION 013100 - PROJECT MANAGEMENT AND COORDINATION

2. Number and title of related Specification Section(s) covered by subcontract.

- B. Key Personnel Names: Within 15 days of Notice To Proceed, submit a list of key personnel assignments, including superintendent and other personnel in attendance at Project site. Identify individuals and their duties and responsibilities; list addresses and telephone numbers, including office and cellular telephone numbers and e-mail addresses. Provide names, addresses, and telephone numbers of individuals assigned as alternates in the absence of individuals assigned to Project.
1. Post copies of list in project meeting room, in temporary field office, and by each temporary telephone once on site work commences. Keep list current at all times.

1.5 GENERAL COORDINATION PROCEDURES

- A. Coordination: Coordinate construction operations included in different Sections of the Specifications to ensure efficient and orderly installation of each part of the Work. Coordinate construction operations, included in different Sections that depend on each other for proper installation, connection, and operation.
1. Schedule construction operations in sequence required to obtain the best results where installation of one part of the Work depends on installation of other components, before or after its own installation.
 2. Coordinate installation of different components to ensure maximum performance and accessibility for required maintenance, service, and repair.
 3. Make adequate provisions to accommodate items scheduled for later installation.
- B. Prepare memoranda for distribution to each party involved, outlining special procedures required for coordination. Include such items as required notices, reports, and list of attendees at meetings.
1. Prepare similar memoranda for Owner and separate contractors if coordination of their Work is required.
- C. Administrative Procedures: Coordinate scheduling and timing of required administrative procedures with other construction activities to avoid conflicts and to ensure orderly progress of the Work. Such administrative activities include, but are not limited to, the following:
1. Preparation of Contractor's construction schedule.
 2. Preparation of the schedule of values.
 3. Installation and removal of temporary facilities and controls.
 4. Delivery and processing of submittals.
 5. Progress meetings.
 6. Preinstallation conferences.
 7. Project closeout activities.
 8. Startup and adjustment of systems.
- D. Salvage materials and equipment involved in performance of, but not actually incorporated into, the Work. See other Sections for disposition of salvaged materials that are designated as Owner's property.

SECTION 013100 - PROJECT MANAGEMENT AND COORDINATION

1.6 REQUESTS FOR INFORMATION (RFIs)

- A. General: Immediately on discovery of the need for additional information or interpretation of the Contract Documents, Contractor shall prepare and submit an RFI in the form specified.
1. Architect will return RFIs submitted to Architect by other entities controlled by Contractor with no response.
 2. Coordinate and submit RFIs in a prompt manner so as to avoid delays in Contractor's work or work of subcontractors.
- B. Content of the RFI: Include a detailed, legible description of item needing information or interpretation and the following:
1. Project name.
 2. Project number.
 3. Date.
 4. Name of Contractor.
 5. Name of Architect.
 6. RFI number, numbered sequentially.
 7. RFI subject.
 8. Specification Section number and title and related paragraphs, as appropriate.
 9. Drawing number and detail references, as appropriate.
 10. Field dimensions and conditions, as appropriate.
 11. Contractor's suggested resolution. If Contractor's suggested resolution impacts the Contract Time or the Contract Sum, Contractor shall state impact in the RFI.
 12. Contractor's signature.
 13. Attachments: Include sketches, descriptions, measurements, photos, Product Data, Shop Drawings, coordination drawings, and other information necessary to fully describe items needing interpretation.
 - a. Include dimensions, thicknesses, structural grid references, and details of affected materials, assemblies, and attachments on attached sketches.
- C. RFI Forms: AIA Document G716 or other approved form.
1. Form and Attachments shall be electronic files in Adobe Acrobat PDF format.
- D. Architect's Action: Architect will review each RFI, determine action required, and respond. Allow seven working days for Architect's response for each RFI.
1. The following Contractor-generated RFIs will be returned without action:
 - a. Requests for approval of submittals.
 - b. Requests for approval of substitutions.
 - c. Requests for approval of Contractor's means and methods.
 - d. Requests for coordination information already indicated in the Contract Documents.
 - e. Requests for adjustments in the Contract Time or the Contract Sum.
 - f. Requests for interpretation of Architect's actions on submittals.
 - g. Incomplete RFIs or inaccurately prepared RFIs.

SECTION 013100 - PROJECT MANAGEMENT AND COORDINATION

2. Architect's action may include a request for additional information, in which case Architect's time for response will date from time of receipt of additional information.
 3. Architect's action on RFIs that may result in a change to the Contract Time or the Contract Sum may be eligible for Contractor to submit Change Proposal according to Section 012600 "Contract Modification Procedures."
 - a. If Contractor believes the RFI response warrants change in the Contract Time or the Contract Sum, notify Architect in writing within 5 days of receipt of the RFI response.
- E. RFI Log: Prepare, maintain, and submit a tabular log of RFIs organized by the RFI number. Submit log weekly. Include the following:
1. Project name.
 2. RFI number including RFIs that were returned without action or withdrawn.
 3. RFI description.
 4. Date the RFI was submitted.
 5. Date Architect's response was received.
- F. On receipt of Architect's action, update the RFI log and immediately distribute the RFI response to affected parties. Review response and notify Architect within 5 days if Contractor disagrees with response.
- 1.7 DESIGN CLARIFICATIONS (DCs)
- A. On receipt of Design Clarification immediately distribute the DC to affected parties.
1. Architect's action on DCs that may result in a change to the Contract Time or the Contract Sum may be eligible for Contractor to submit Change Proposal according to Section 012600 "Contract Modification Procedures."
 - a. If Contractor believes the DC warrants change in the Contract Time or the Contract Sum, notify Architect in writing within 7 days of receipt of the DC.
- 1.8 PROJECT MEETINGS
- A. General: Owner's representative to schedule and conduct meetings and conferences at Project site unless otherwise indicated.
1. Attendees: Inform participants and others involved, and individuals whose presence is required, of date and time of each meeting.
 2. Agenda: Owner's representative to prepare the meeting agenda. Distribute the agenda to all invited attendees.
 3. Minutes: Entity responsible for conducting meeting will record and distribute meeting minutes.
- B. Preconstruction Conference: Owner's Representative will schedule and conduct a preconstruction conference before starting construction, at a time convenient to Owner and Architect, but no later than 15 days of Notice to Proceed.

SECTION 013100 - PROJECT MANAGEMENT AND COORDINATION

1. Conduct the conference to review responsibilities and personnel assignments.
 2. Attendees: Authorized representatives of Owner Architect, and their consultants; Contractor and its superintendent; major subcontractors; suppliers; and other concerned parties shall attend the conference. Participants at the conference shall be familiar with Project and authorized to conclude matters relating to the Work.
 3. Agenda: Discuss items of significance that could affect progress, including the following:
 - a. Tentative construction schedule.
 - b. Critical work sequencing and long-lead items.
 - c. Designation of key personnel and their duties.
 - d. Lines of communications.
 - e. Procedures for processing field decisions and Change Orders.
 - f. Procedures for RFIs & DC's.
 - g. Procedures for testing and inspecting.
 - h. Procedures for processing Applications for Payment.
 - i. Distribution of the Contract Documents.
 - j. Submittal procedures.
 - k. Use of the premises and existing building.
 - l. Work restrictions.
 - m. Working hours.
 - n. Owner's occupancy requirements.
 - o. Responsibility for temporary facilities and controls.
 - p. Procedures for disruptions and shutdowns.
 - q. Construction waste management and recycling.
 - r. Parking availability.
 - s. Office, work, and storage areas.
 - t. Equipment deliveries and priorities.
 - u. First aid.
 - v. Security.
 - w. Progress cleaning.
- C. Pre-installation Conferences: Contractor shall conduct a pre-installation conference at Project site before each construction activity that requires coordination with other construction.
1. Attendees: Installer and representatives of manufacturers and fabricators involved in or affected by the installation and its coordination or integration with other materials and installations that have preceded or will follow, shall attend the meeting. Advise Owner's Representative, Architect, and Owner's Commissioning Authority of scheduled meeting dates.
 2. Agenda: Review progress of other construction activities and preparations for the particular activity under consideration, including requirements for the following:
 - a. Contract Documents.
 - b. Options.
 - c. Related RFIs & DC's.
 - d. Related Change Orders.
 - e. Submittals.
 - f. Possible conflicts.
 - g. Compatibility requirements.
 - h. Manufacturer's written instructions.

SECTION 013100 - PROJECT MANAGEMENT AND COORDINATION

- i. Warranty requirements.
 - j. Compatibility of materials.
 - k. Acceptability of substrates.
 - l. Temporary facilities and controls.
 - m. Space and access limitations.
 - n. Regulations of authorities having jurisdiction.
 - o. Installation procedures.
 - p. Coordination with other work.
 - q. Protection of adjacent work.
3. Record significant conference discussions, agreements, and disagreements, including required corrective measures and actions.
 4. Do not proceed with installation if the conference cannot be successfully concluded. Initiate whatever actions are necessary to resolve impediments to performance of the Work and reconvene the conference at earliest feasible date.
- D. Progress Meetings: Owner's representative to conduct progress meetings at weekly intervals.
1. Attendees: In addition to representatives of Owner and Architect, each contractor, subcontractor, supplier, and other entity concerned with current progress or involved in planning, coordination, or performance of future activities shall be represented at these meetings. All participants at the meeting shall be familiar with Project and authorized to conclude matters relating to the Work.
 2. Agenda: Review and correct or approve minutes of previous progress meeting. Review other items of significance that could affect progress. Include topics for discussion as appropriate to status of Project.
 - a. Contractor's Construction Schedule: Review progress since the last meeting. Determine whether each activity is on time, ahead of schedule, or behind schedule, in relation to Contractor's construction schedule. Determine how construction behind schedule will be expedited; secure commitments from parties involved to do so. Discuss whether schedule revisions are required to ensure that current and subsequent activities will be completed within the Contract Time.
 - 1) Review schedule for next period.
 - b. Review present and future needs of each entity present, including the following:
 - 1) Sequence of operations.
 - 2) Status of submittals.
 - 3) Status of correction of deficient items.
 - 4) Field observations.
 - 5) Status of RFIs & DC's.
 - 6) Status of proposal requests.
 - 7) Pending changes.
 - 8) Status of Change Orders.
 - 9) Pending claims and disputes.
 - 10) Documentation of information for payment requests.

SECTION 013100 - PROJECT MANAGEMENT AND COORDINATION

- c. **Schedule Updating:** Contractor shall revise construction schedule after each progress meeting where revisions to the schedule have been made or recognized. Issue revised schedule prior to next meeting.

1.9 PROJECT MANAGEMENT SOFTWARE

- A. **General:** The Contractor's use of project management software for distribution, organization, and storage of project information is at the sole discretion of the Owner. The Owner has no obligation to permit the use of the Contractor's proposed project management software. Approval of all requests will be on a case-by-case basis. Electronic project documentation utilizing emails and PDF files will be the default unless Owner deems alternative software acceptable. Owner can rescind approval of Contractor's project management software without cause at any time during project.

PART 2 - PRODUCTS (Not Used)

PART 3 - EXECUTION (Not Used)

END OF SECTION

SECTION 013200 - CONSTRUCTION PROGRESS DOCUMENTATION

PART 1 - GENERAL

1.1 RELATED DOCUMENTS

- A. Drawings and general provisions of the Contract, including General and Supplementary Conditions and other Division 01 Specification Sections, apply to this Section.

1.2 SUMMARY

- A. Section includes administrative and procedural requirements for documenting the progress of construction during performance of the Work, including the following:
 - 1. Contractor's construction schedule.
 - 2. Construction schedule updating reports.
 - 3. Daily construction reports.
 - 4. Site condition reports.
 - 5. Special reports.
- B. Related Requirements:
 - 1. Section 013300 "Submittal Procedures" for submitting schedules and reports.
 - 2. Section 014000 "Quality Requirements" for submitting a schedule of tests and inspections.

1.3 DEFINITIONS

- A. Activity: A discrete part of a project that can be identified for planning, scheduling, monitoring, and controlling the construction project. Activities included in a construction schedule consume time and resources.
 - 1. Critical Activity: An activity on the critical path that must start and finish on the planned early start and finish times.
 - 2. Predecessor Activity: An activity that precedes another activity in the network.
 - 3. Successor Activity: An activity that follows another activity in the network.
- B. CPM: Critical path method, which is a method of planning and scheduling a construction project where activities are arranged based on activity relationships. Network calculations determine when activities can be performed and the critical path of Project.
- C. Critical Path: The longest connected chain of interdependent activities through the network schedule that establishes the minimum overall Project duration and contains no float.
- D. Event: The starting or ending point of an activity.
- E. Float: The measure of leeway in starting and completing an activity.

SECTION 013200 - CONSTRUCTION PROGRESS DOCUMENTATION

1. Float time is not for the exclusive use or benefit of either Owner or Contractor, but is a jointly owned, expiring Project resource available to both parties as needed to meet schedule milestones and Contract completion date.
2. Free float is the amount of time an activity can be delayed without adversely affecting the early start of the successor activity.
3. Total float is the measure of leeway in starting or completing an activity without adversely affecting the planned Project completion date.

1.4 INFORMATIONAL SUBMITTALS

- A. Format for Submittals: Submit required submittals in the following format:
 1. Working electronic copy of schedule file, where indicated.
 2. PDF electronic file.
- B. Contractor's Construction Schedule: Initial schedule, of size required to display entire schedule for entire construction period.
- C. Construction Schedule Updating Reports: Submit with Applications for Payment.
- D. Daily Construction Reports: Submit at daily or weekly intervals.
- E. Site Condition Reports: Submit at time of discovery of differing conditions.
- F. Special Reports: Submit at time of unusual event.

PART 2 - PRODUCTS

2.1 CONTRACTOR'S CONSTRUCTION SCHEDULE, GENERAL

- A. Time Frame: Extend schedule from date established for the Notice to Proceed to date of Substantial Completion and Final completion of project.
 1. Contract completion date shall not be changed by submission of a schedule that shows an early completion date, unless specifically authorized by Change Order.
- B. Activities: At a minimum, provide a separate numbered activity for each specification section and main element of the Work. Comply with the following:
 1. Activity Duration: Define activities so no activity is longer than 10 days, unless specifically allowed by Architect.
 2. Activity Grouping: Group activities by separate project areas to provide a standalone schedule for each project area. Coordinate activities between project areas.
 3. Procurement Activities: Include procurement process activities for the following long lead items and major items requiring a cycle of more than 60 days, as separate activities in schedule. Procurement cycle activities include, but are not limited to, submittals, approvals, purchasing, fabrication, and delivery.
 4. Startup and Testing Time: Include no fewer than 5 days for startup and testing.

SECTION 013200 - CONSTRUCTION PROGRESS DOCUMENTATION

5. Substantial Completion: Indicate completion in advance of date established for Substantial Completion, and allow time for Architect's administrative procedures necessary for certification of Substantial Completion.
 6. Punch List and Final Completion: Include not more than 20 days for completion of punch list items and final completion.
- C. Constraints: Include constraints and work restrictions indicated in the Contract Documents and as follows in schedule, and show how the sequence of the Work is affected.
1. Construction Areas:
 - a. Phase 1: All work required for full operation of CT Room 1314 and CT Control Room 1314A. Notice of Completion for phase 1 before beginning construction phase 2. Work areas in support of this phase can be found on sheet D101 and A101 of the Drawings.
 - b. Phase 2: All work required for full operation of CT Room 1361, CT Control Room 1361A, and MRI Room 1358. A second Notice of Completion will be provided for phase 2. Work areas in support of this phase can be found on sheet D101 and A101 of the Drawings.
- D. Milestones: Include milestones indicated in the Contract Documents in schedule, including, but not limited to, the Notice to Proceed, Substantial Completion, and final completion for each project area and dates of building occupancy.
- E. Recovery Schedule: When periodic update indicates the Work is 7 or more calendar days behind the current approved schedule, submit a separate recovery schedule indicating means by which Contractor intends to regain compliance with the schedule. Indicate changes to working hours, working days, crew sizes, and equipment required to achieve compliance, and date by which recovery will be accomplished.
- F. Computer Scheduling Software: Prepare schedules using current version of a program that has been developed specifically to manage construction schedules.

2.2 CONTRACTOR'S CONSTRUCTION SCHEDULE (CPM SCHEDULE)

- A. CPM Schedule: Prepare and submit Contractor's construction schedule no later than 28 days after date established for the Notice to Proceed.
1. Activities: Indicate the estimated time duration, sequence requirements, and relationship of each activity in relation to other activities.
 2. Critical Path Activities: Identify critical path activities; scheduled start and completion dates shall be consistent with Contract milestone dates.
- B. Contract Modifications: For each proposed contract modification and concurrent with its submission, prepare a time-impact analysis using a network fragment to demonstrate the effect of the proposed change on the overall project schedule.

SECTION 013200 - CONSTRUCTION PROGRESS DOCUMENTATION

2.3 REPORTS

- A. Daily Construction Reports: Prepare a daily construction report recording the following information concerning events at Project site:
1. List of subcontractors at Project site.
 2. List of separate contractors at Project site.
 3. Approximate count of personnel at Project site.
 4. Equipment at Project site.
 5. Material deliveries.
 6. High and low temperatures and general weather conditions, including presence of rain or snow.
 7. Accidents.
 8. Stoppages, delays, shortages, and losses.
 9. Emergency procedures.
 10. Orders and requests of authorities having jurisdiction.
 11. Services connected and disconnected.
 12. Equipment or system tests and startups.
- B. Site Condition Reports: Immediately on discovery of a difference between site conditions and the Contract Documents, prepare and submit a detailed report. Submit with a Request for Information. Include a detailed description of the differing conditions, together with recommendations for changing the Contract Documents.

2.4 SPECIAL REPORTS

- A. General: Submit special reports directly to Owner within one day of an occurrence. Distribute copies of report to parties affected by the occurrence.
- B. Reporting Unusual Events: When an event of an unusual and significant nature occurs at Project site, whether or not related directly to the Work, prepare and submit a special report.

PART 3 - EXECUTION

3.1 CONTRACTOR'S CONSTRUCTION SCHEDULE

- A. Contractor's Construction Schedule Updating: At weekly intervals, update schedule to reflect actual construction progress and activities. Issue schedule two days before each regularly scheduled weekly progress meeting.
- B. Distribution: Distribute copies of approved schedule to Architect, Owner, separate contractors, testing and inspecting agencies, and other parties identified by Contractor with a need-to-know schedule responsibility.

END OF SECTION

SECTION 013300 - SUBMITTAL PROCEDURES

PART 1 - GENERAL

1.1 RELATED DOCUMENTS

- A. Drawings and general provisions of the Contract, including General and Supplementary Conditions and other Division 01 Specification Sections, apply to this Section.

1.2 SUMMARY

- A. Section includes requirements for the submittal schedule and administrative and procedural requirements for submitting Shop Drawings, Product Data, Samples, and other submittals.
- B. Related Requirements:
 - 1. Section 013200 "Construction Progress Documentation" for submitting schedules and reports, including Contractor's construction schedule.
 - 2. Section 017823 "Operation and Maintenance Data" for submitting operation and maintenance manuals.
 - 3. Section 017839 "Project Record Documents" for submitting record Drawings, record Specifications, and record Product Data.

1.3 DEFINITIONS

- A. Action Submittals: Written and graphic information and physical samples that require Architect's responsive action. Action submittals are those submittals indicated in individual Specification Sections as "action submittals."
- B. Informational Submittals: Written and graphic information and physical samples that do not require Architect's responsive action. Submittals may be rejected for not complying with requirements. Informational submittals are those submittals indicated in individual Specification Sections as "informational submittals."
- C. File Transfer Protocol (FTP): Communications protocol that enables transfer of files to and from another computer over a network and that serves as the basis for standard Internet protocols. An FTP site is a portion of a network located outside of network firewalls within which internal and external users are able to access files.
- D. Portable Document Format (PDF): An open standard file format licensed by Adobe Systems used for representing documents in a device-independent and display resolution-independent fixed-layout document format.

1.4 SUBMITTAL ADMINISTRATIVE REQUIREMENTS

- A. Architect's Digital Data Files: Electronic digital data files of the Contract Drawings will be provided by Owner for Contractor's use in preparing submittals.

SECTION 013300 - SUBMITTAL PROCEDURES

1. Owner will furnish Contractor one set of digital data drawing files of the Contract Drawings for use in preparing Shop Drawings.
 - a. Architect makes no representations as to the accuracy or completeness of digital data drawing files as they relate to the Contract Drawings.
- B. Coordination: Coordinate preparation and processing of submittals with performance of construction activities. Architect reserves the right to withhold action on a submittal requiring coordination with other submittals until related submittals are received.
- C. Processing Time: Allow time for submittal review, including time for resubmittals, as follows: 15 days for each review. Time for review shall commence on Architect's receipt of submittal. No extension of the Contract Time will be authorized because of failure to transmit submittals enough in advance of the Work to permit processing, including resubmittals.
- D. Paper Submittals: (Where electronic submittal is impossible or owner requests a paper submittal) Place a permanent label or title block on each submittal item for identification.
 1. Indicate name of firm or entity that prepared each submittal on label or title block.
 2. Provide a space approximately 6 by 8 inches (150 by 200 mm) on label or beside title block to record Contractor's review and approval markings and action taken by Architect.
 3. Include the following information for processing and recording action taken:
 - a. Project name.
 - b. Date.
 - c. Name of Contractor.
 - d. Name of subcontractor.
 - e. Name of supplier.
 - f. Name of manufacturer.
 - g. Submittal number or other unique identifier, including revision identifier.
 - 1) Submittal number shall use project number followed by Specification Section number followed by a decimal point and then a sequential number (e.g., 061000.01). Resubmittals shall include an alphabetic suffix after another decimal point (e.g., 061000.01.A).
 - h. Number and title of appropriate Specification Section.
 - i. Drawing number and detail references, as appropriate.
 - j. Location(s) where product is to be installed, as appropriate.
 - k. Other necessary identification.
 4. Additional Paper Copies: Unless additional copies are required for final submittal, and unless Architect observes noncompliance with provisions in the Contract Documents, initial submittal may serve as final submittal.
 5. Transmittal for Paper Submittals: Assemble each submittal individually and appropriately for transmittal and handling. Transmit each submittal using a transmittal form. Architect will discard submittals received from sources other than Contractor.
 - a. Transmittal Form for Paper Submittals: Use AIA Document G810 or a similar document.

SECTION 013300 - SUBMITTAL PROCEDURES

- E. Electronic Submittals: Identify and incorporate information in each electronic submittal file as follows:
1. Provide a single Adobe Acrobat .PDF file for each specification section. Provide a transmittal form as first page of the submittal file. Provide bookmarks enabling navigation within the file to each submittal item. Incomplete submittals will be rejected.
 2. File name shall use Specification Section Number and Title. Resubmittals shall identify version of submittal by application of suffix "v" and the number of the resubmittal.
 3. Provide means for insertion to permanently record Contractor's review and approval markings and action taken by Architect.
 4. Transmittal Form for Electronic Submittals: Use electronic form acceptable to Owner, containing the following information:
 - a. Project name.
 - b. Date.
 - c. Name of Contractor.
 - d. Name of firm or entity that prepared submittal.
 - e. Names of subcontractor, manufacturer, and supplier.
 - f. Category and type of submittal.
 - g. Submittal purpose and description.
- F. Options: Identify options requiring selection by Architect.
- G. Deviations and Additional Information: On an attached separate sheet, prepared on Contractor's letterhead, record relevant information, requests for data, revisions other than those requested by Architect on previous submittals, and deviations from requirements in the Contract Documents, including minor variations and limitations. Include same identification information as related submittal.
- H. Resubmittals: Make resubmittals in same form and number of copies as initial submittal.
1. Note date and content of previous submittal.
 2. Note date and content of revision in label or title block and clearly indicate extent of revision.
 3. Resubmit submittals until they are marked with approval notation from Architect's action stamp.
 4. Resubmittals shall be complete and partial resubmittals of corrected or additional information will not be accepted. Resubmittals shall contain all submittal information required for the specification section.
- I. Distribution: Furnish copies of final submittals to manufacturers, subcontractors, suppliers, fabricators, installers, authorities having jurisdiction, and others as necessary for performance of construction activities. Show distribution on transmittal forms.
- J. Use for Construction: Retain complete copies of submittals on Project site. Use only final action submittals that are marked with approval notation from Architect's action stamp.

SECTION 013300 - SUBMITTAL PROCEDURES

PART 2 - PRODUCTS

2.1 SUBMITTAL PROCEDURES

- A. General Submittal Procedure Requirements: Prepare and submit submittals required by individual Specification Sections. Types of submittals are indicated in individual Specification Sections or Drawings.
1. Post electronic submittals as PDF electronic files directly to designated site with automatic email notification to Architect or Submit electronic submittals via email as PDF electronic files.
 - a. Architect will return annotated file. Annotate and retain one copy of file as an electronic Project record document file.
 2. Action Submittals: Submit five paper copies of each submittal unless otherwise indicated. Architect will return two copies.
 3. Informational Submittals: Submit two paper copies of each submittal unless otherwise indicated. Architect will not return copies.
 4. Certificates and Certifications Submittals: Provide a statement that includes signature of entity responsible for preparing certification. Certificates and certifications shall be signed by an officer or other individual authorized to sign documents on behalf of that entity.
 - a. Provide a notarized statement on original paper copy certificates and certifications where indicated.
- B. Product Data: Provide product data for all specified products.
- C. Shop Drawings: Prepare Project-specific information, drawn accurately to scale for all custom fabrication work. Do not base Shop Drawings on reproductions of the Contract Documents or standard printed data.
1. Preparation: Fully illustrate requirements in the Contract Documents. Include the following information, as applicable:
 - a. Identification of products.
 - b. Schedules.
 - c. Compliance with specified standards.
 - d. Notation of coordination requirements.
 - e. Notation of dimensions established by field measurement.
 - f. Relationship and attachment to adjoining construction clearly indicated.
 - g. Seal and signature of professional engineer if specified.
- D. Samples: Submit Samples for review of kind, color, pattern, and texture for a check of these characteristics with other elements and for a comparison of these characteristics between submittal and actual component as delivered and installed.
1. Samples for Initial Selection: Submit manufacturer's color charts consisting of units or sections of units showing the full range of colors, textures, and patterns available.

SECTION 013300 - SUBMITTAL PROCEDURES

- a. Number of Samples: Submit one full set of available choices where color, pattern, texture, or similar characteristics are required to be selected from manufacturer's product line. Architect will return submittal with options selected.
2. Samples for Verification: Submit full-size units or Samples of size indicated, prepared from same material to be used for the Work, cured and finished in manner specified, and physically identical with material or product proposed for use, and that show full range of color and texture variations expected.
 - a. Number of Samples: Submit three sets of Samples. Architect will retain one Sample sets; remainder will be returned. Mark up and retain one returned Sample set as a project record sample.
- E. Coordination Drawing Submittals: Comply with requirements specified in Section 013100 "Project Management and Coordination."
- F. Contractor's Construction Schedule: Comply with requirements specified in Section 013200 "Construction Progress Documentation."
- G. Test and Inspection Reports and Schedule of Tests and Inspections Submittals: Comply with requirements specified in Section 014000 "Quality Requirements."
- H. Closeout Submittals and Maintenance Material Submittals: Comply with requirements specified in Section 017700 "Closeout Procedures."
- I. Maintenance Data: Comply with requirements specified in Section 017823 "Operation and Maintenance Data."
- J. Qualification Data: Prepare written information that demonstrates capabilities and experience of firm or person. Include lists of completed projects with project names and addresses, contact information of architects and owners, and other information specified.
- K. Welding Certificates: Prepare written certification that welding procedures and personnel comply with requirements in the Contract Documents. Submit record of Welding Procedure Specification and Procedure Qualification Record on AWS forms. Include names of firms and personnel certified.
- L. Installer Certificates: Submit written statements on manufacturer's letterhead certifying that Installer complies with requirements in the Contract Documents and, where required, is authorized by manufacturer for this specific Project.
- M. Manufacturer Certificates: Submit written statements on manufacturer's letterhead certifying that manufacturer complies with requirements in the Contract Documents. Include evidence of manufacturing experience where required.
- N. Product Certificates: Submit written statements on manufacturer's letterhead certifying that product complies with requirements in the Contract Documents.
- O. Material Certificates: Submit written statements on manufacturer's letterhead certifying that material complies with requirements in the Contract Documents.

SECTION 013300 - SUBMITTAL PROCEDURES

- P. Material Test Reports: Submit reports written by a qualified testing agency, on testing agency's standard form, indicating and interpreting test results of material for compliance with requirements in the Contract Documents.
- Q. Product Test Reports: Submit written reports indicating that current product produced by manufacturer complies with requirements in the Contract Documents. Base reports on evaluation of tests performed by manufacturer and witnessed by a qualified testing agency, or on comprehensive tests performed by a qualified testing agency.
- R. Research Reports: Submit written evidence, from a model code organization acceptable to authorities having jurisdiction, that product complies with building code in effect for Project.
- S. Preconstruction Test Reports: Submit reports written by a qualified testing agency, on testing agency's standard form, indicating and interpreting results of tests performed before installation of product, for compliance with performance requirements in the Contract Documents.
- T. Compatibility Test Reports: Submit reports written by a qualified testing agency, on testing agency's standard form, indicating and interpreting results of compatibility tests performed before installation of product. Include written recommendations for primers and substrate preparation needed for adhesion.
- U. Field Test Reports: Submit written reports indicating and interpreting results of field tests performed either during installation of product or after product is installed in its final location, for compliance with requirements in the Contract Documents.
- V. Design Data: Prepare and submit written and graphic information, including, but not limited to, performance and design criteria, list of applicable codes and regulations, and calculations. Include list of assumptions and other performance and design criteria and a summary of loads. Include load diagrams if applicable. Provide name and version of software, if any, used for calculations. Include page numbers.

2.2 DELEGATED-DESIGN SERVICES

- A. Performance and Design Criteria: Where professional design services or certifications by a design professional are specifically required of Contractor by the Contract Documents, provide products and systems complying with specific performance and design criteria indicated.
 - 1. If criteria indicated are not sufficient to perform services or certification required, submit a written request for additional information to Architect.
- B. Delegated-Design Services Certification: In addition to Shop Drawings, Product Data, and other required submittals, submit digitally signed PDF electronic file copies of certificate, signed and sealed by the responsible design professional, for each product and system specifically assigned to Contractor to be designed or certified by a design professional.
 - 1. Indicate that products and systems comply with performance and design criteria in the Contract Documents. Include list of codes, loads, and other factors used in performing these services.

SECTION 013300 - SUBMITTAL PROCEDURES

PART 3 - EXECUTION

3.1 GENERAL

- A. The contractor is responsible to assure submittals are correct and complete prior to submission for review. A maximum of two reviews by the design team is expected to be adequate to obtain approval. At the owner's discretion, costs for additional submittal review (in excess of two reviews) may be charged to the contractor. Charges will be withheld from contractor payments.

3.2 CONTRACTOR'S REVIEW

- A. Action and Informational Submittals: Review each submittal and check for coordination with other Work of the Contract and for compliance with the Contract Documents. Note corrections and field dimensions. Mark with approval stamp before submitting to Architect.
- B. Project Closeout and Maintenance Material Submittals: See requirements in Section 017700 "Closeout Procedures."
- C. Approval Stamp: Stamp each submittal with a uniform, approval stamp. Include Project name and location, submittal number, Specification Section title and number, name of reviewer, date of Contractor's approval, and statement certifying that submittal has been reviewed, checked, and approved for compliance with the Contract Documents.

3.3 ARCHITECT'S ACTION

- A. Action Submittals: Architect will review each submittal, make marks to indicate corrections or revisions required, and return it. Architect will stamp each submittal with an action stamp and will mark stamp appropriately to indicate action.
- B. Informational Submittals: Architect will review each submittal and will not return it, or will return it if it does not comply with requirements. Architect will forward each submittal to appropriate party.
- C. Partial submittals prepared for a portion of the Work will only be reviewed when use of partial submittals has received prior approval from Architect.
- D. Incomplete submittals are unacceptable, will be considered nonresponsive, and will be returned for resubmittal without review.
- E. Submittals not required by the Contract Documents may be returned by the Architect without action.
- F. Approval of a submittal that deviates from the Construction Documents does not relieve the Contractor of their responsibility to perform the Work in accordance with the Construction Documents.

END OF SECTION

SECTION 014000 - QUALITY REQUIREMENTS

PART 1 - GENERAL

1.1 RELATED DOCUMENTS

- A. Drawings and general provisions of the Contract, including General and Supplementary Conditions and other Division 01 Specification Sections, apply to this Section.

1.2 SUMMARY

- A. Section includes administrative and procedural requirements for quality assurance and quality control.
- B. Testing and inspecting services are required to verify compliance with requirements specified or indicated. These services do not relieve Contractor of responsibility for compliance with the Contract Document requirements.
 - 1. Specific quality-assurance and -control requirements for individual construction activities are specified in the Sections that specify those activities. Requirements in those Sections may also cover production of standard products.
 - 2. Specified tests, inspections, and related actions do not limit Contractor's other quality-assurance and -control procedures that facilitate compliance with the Contract Document requirements.
 - 3. Requirements for Contractor to provide quality-assurance and -control services required by Architect, Owner, Commissioning Authority, or authorities having jurisdiction are not limited by provisions of this Section.
 - 4. Specific test and inspection requirements are not specified in this Section.

1.3 DEFINITIONS

- A. Quality-Assurance Services: Activities, actions, and procedures performed before and during execution of the Work to guard against defects and deficiencies and substantiate that proposed construction will comply with requirements.
- B. Quality-Control Services: Tests, inspections, procedures, and related actions during and after execution of the Work to evaluate that actual products incorporated into the Work and completed construction comply with requirements. Services do not include contract enforcement activities performed by Architect or Owner's Representative.
- C. Preconstruction Testing: Tests and inspections performed specifically for Project before products and materials are incorporated into the Work, to verify performance or compliance with specified criteria.
- D. Product Testing: Tests and inspections that are performed by an NRTL, an NVLAP, or a testing agency qualified to conduct product testing and acceptable to authorities having jurisdiction, to establish product performance and compliance with specified requirements.

SECTION 014000 - QUALITY REQUIREMENTS

- E. Source Quality-Control Testing: Tests and inspections that are performed at the source, e.g., plant, mill, factory, or shop.
- F. Field Quality-Control Testing: Tests and inspections that are performed on-site for installation of the Work and for completed Work.
- G. Testing Agency: An entity engaged to perform specific tests, inspections, or both. Testing laboratory shall mean the same as testing agency.
- H. Installer/Applicator/Erector: Contractor or another entity engaged by Contractor as an employee, Subcontractor, or Sub-subcontractor, to perform a particular construction operation, including installation, erection, application, and similar operations.
 - 1. Use of trade-specific terminology in referring to a trade or entity does not require that certain construction activities be performed by accredited or unionized individuals, or that requirements specified apply exclusively to specific trade(s).
- I. Experienced: When used with an entity or individual, "experienced" means having successfully completed a minimum of five previous projects similar in nature, size, and extent to this Project; being familiar with special requirements indicated; and having complied with requirements of authorities having jurisdiction.

1.4 CONFLICTING REQUIREMENTS

- A. Referenced Standards: If compliance with two or more standards is specified and the standards establish different or conflicting requirements for minimum quantities or quality levels, comply with the most stringent requirement. Refer conflicting requirements that are different, but apparently equal, to Architect for a decision before proceeding.
- B. Minimum Quantity or Quality Levels: The quantity or quality level shown or specified shall be the minimum provided or performed. The actual installation may comply exactly with the minimum quantity or quality specified, or it may exceed the minimum within reasonable limits. To comply with these requirements, indicated numeric values are minimum or maximum, as appropriate, for the context of requirements. Refer uncertainties to Architect for a decision before proceeding.

1.5 REPORTS AND DOCUMENTS

- A. Test and Inspection Reports: Prepare and submit certified written reports specified in other Sections. Include the following:
 - 1. Date of issue.
 - 2. Project title and number.
 - 3. Name, address, and telephone number of testing agency.
 - 4. Dates and locations of samples and tests or inspections.
 - 5. Names of individuals making tests and inspections.
 - 6. Description of the Work and test and inspection method.
 - 7. Identification of product and Specification Section.
 - 8. Complete test or inspection data.

SECTION 014000 - QUALITY REQUIREMENTS

9. Test and inspection results and an interpretation of test results.
10. Record of temperature and weather conditions at time of sample taking and testing and inspecting.
11. Comments or professional opinion on whether tested or inspected Work complies with the Contract Document requirements.
12. Name and signature of laboratory inspector.
13. Recommendations on retesting and reinspecting.

- B. Permits, Licenses, and Certificates: For Owner's records, submit copies of permits, licenses, certifications, inspection reports, releases, jurisdictional settlements, notices, receipts for fee payments, judgments, correspondence, records, and similar documents, established for compliance with standards and regulations bearing on performance of the Work.

1.6 QUALITY ASSURANCE

- A. General: Qualifications paragraphs in this article establish the minimum qualification levels required; individual Specification Sections specify additional requirements.
- B. Manufacturer Qualifications: A firm experienced in manufacturing products or systems similar to those indicated for this Project and with a record of successful in-service performance, as well as sufficient production capacity to produce required units.
- C. Fabricator Qualifications: A firm experienced in producing products similar to those indicated for this Project and with a record of successful in-service performance, as well as sufficient production capacity to produce required units.
- D. Installer Qualifications: A firm or individual experienced in installing, erecting, or assembling work similar in material, design, and extent to that indicated for this Project, whose work has resulted in construction with a record of successful in-service performance.
- E. Specialists: Certain Specification Sections require that specific construction activities shall be performed by entities who are recognized experts in those operations. Specialists shall satisfy qualification requirements indicated and shall be engaged for the activities indicated.
1. Requirements of authorities having jurisdiction shall supersede requirements for specialists.
- F. Manufacturer's Technical Representative Qualifications: An authorized representative of manufacturer who is trained and approved by manufacturer to observe and inspect installation of manufacturer's products that are similar in material, design, and extent to those indicated for this Project.
- G. Factory-Authorized Service Representative Qualifications: An authorized representative of manufacturer who is trained and approved by manufacturer to inspect installation of manufacturer's products that are similar in material, design, and extent to those indicated for this Project.
- H. Preconstruction Testing: Where testing agency is indicated to perform preconstruction testing for compliance with specified requirements for performance and test methods, comply with the following:

SECTION 014000 - QUALITY REQUIREMENTS

1. Contractor responsibilities include the following:
 - a. Provide test specimens representative of proposed products and construction.
 - b. Submit specimens in a timely manner with sufficient time for testing and analyzing results to prevent delaying the Work.
 - c. Provide sizes and configurations of test assemblies, mockups, and laboratory mockups to adequately demonstrate capability of products to comply with performance requirements.
 - d. Build laboratory mockups at testing facility using personnel, products, and methods of construction indicated for the completed Work.
 - e. When testing is complete, remove test specimens, assemblies, and mockups; do not reuse products on Project.
2. Testing Agency Responsibilities: Submit a certified written report of each test, inspection, and similar quality-assurance service to Architect and Commissioning Authority, through Owner's Representative, with copy to Contractor. Interpret tests and inspections and state in each report whether tested and inspected work complies with or deviates from the Contract Documents.

1.7 QUALITY CONTROL

- A. Owner Responsibilities: Where quality-control services are indicated as Owner's responsibility, Owner will engage a qualified testing agency to perform these services.
 1. Owner will furnish Contractor with names, addresses, and telephone numbers of testing agencies engaged and a description of types of testing and inspecting they are engaged to perform.
 2. Costs for retesting and reinspecting construction that replaces or is necessitated by work that failed to comply with the Contract Documents will be charged to Contractor, and the Contract Sum will be adjusted by Change Order.
- B. Contractor Responsibilities: Tests and inspections not explicitly assigned to Owner are Contractor's responsibility. Perform additional quality-control activities required to verify that the Work complies with requirements, whether specified or not.
 1. Unless otherwise indicated, provide quality-control services specified and those required by authorities having jurisdiction. Perform quality-control services required of Contractor by authorities having jurisdiction, whether specified or not.
 2. Where services are indicated as Contractor's responsibility, engage a qualified testing agency to perform these quality-control services.
 3. Notify testing agencies at least 24 hours in advance of time when Work that requires testing or inspecting will be performed.
 4. Where quality-control services are indicated as Contractor's responsibility, submit a certified written report, in duplicate, of each quality-control service.
 5. Testing and inspecting requested by Contractor and not required by the Contract Documents are Contractor's responsibility.
 6. Submit additional copies of each written report directly to authorities having jurisdiction, when they so direct.

SECTION 014000 - QUALITY REQUIREMENTS

- C. Retesting/Reinspecting: Regardless of whether original tests or inspections were Contractor's responsibility, provide quality-control services, including retesting and reinspecting, for construction that replaced Work that failed to comply with the Contract Documents.
- D. Schedule of Tests and Inspections: Prepare a schedule of tests, inspections, and similar quality-control services required by the Contract Documents. Coordinate and submit concurrently with Contractor's construction schedule. Update as the Work progresses.
 - 1. Distribution: Distribute schedule to Owner, Architect, Commissioning Authority, testing agencies, and each party involved in performance of portions of the Work where tests and inspections are required.

1.8 SPECIAL TESTS AND INSPECTIONS

- A. Special Tests and Inspections: Unless otherwise noted, the Owner will engage a qualified special inspector to conduct special tests and inspections required by authorities having jurisdiction as follows:
 - 1. Notifying Architect and Contractor through Owner's Representative promptly of irregularities and deficiencies observed in the Work during performance of its services.
 - 2. Submitting a certified written report of each test, inspection, and similar quality-control service to Architect through Owner's Representative with copy to Contractor and to authorities having jurisdiction.
 - 3. Submitting a final report of special tests and inspections at Substantial Completion, which includes a list of unresolved deficiencies.
 - 4. Interpreting tests and inspections and stating in each report whether tested and inspected work complies with or deviates from the Contract Documents.
 - 5. Retesting and reinspecting corrected work.

PART 2 - PRODUCTS (Not Used)

PART 3 - EXECUTION

3.1 TEST AND INSPECTION LOG

- A. Test and Inspection Log: Prepare a record of tests and inspections. Include the following:
 - 1. Date test or inspection was conducted.
 - 2. Description of the Work tested or inspected.
 - 3. Date test or inspection results were transmitted to Architect.
 - 4. Identification of testing agency or special inspector conducting test or inspection.
- B. Maintain log at Project site. Post changes and revisions as they occur. Provide access to test and inspection log for Architect's reference during normal working hours.

SECTION 014000 - QUALITY REQUIREMENTS

3.2 REPAIR AND PROTECTION

- A. General: On completion of testing, inspecting, sample taking, and similar services, repair damaged construction and restore substrates and finishes.
 - 1. Provide materials and comply with installation requirements specified in other Specification Sections or matching existing substrates and finishes. Restore patched areas and extend restoration into adjoining areas with durable seams that are as invisible as possible. Comply with the Contract Document requirements for cutting and patching in Section 017300 "Execution."
- B. Protect construction exposed by or for quality-control service activities.
- C. Repair and protection are Contractor's responsibility, regardless of the assignment of responsibility for quality-control services.

END OF SECTION

SECTION 014200 - REFERENCES

PART 1 - GENERAL

1.1 RELATED DOCUMENTS

- A. Drawings and general provisions of the Contract, including General and Supplementary Conditions and other Division 01 Specification Sections, apply to this Section.

1.2 DEFINITIONS

- A. General: Basic Contract definitions are included in the Conditions of the Contract.
- B. "Approved": When used to convey Architect's action on Contractor's submittals, applications, and requests, "approved" is limited to Architect's duties and responsibilities as stated in the Conditions of the Contract.
- C. "Conforms to Design": When used to convey Architect's action on Contractor's submittals, applications, and requests, "conforms to design" is limited to Architect's duties and responsibilities as stated in the Conditions of the Contract.
- D. "Directed": A command or instruction by Architect. Other terms including "requested," "authorized," "selected," "required," and "permitted" have the same meaning as "directed."
- E. "Indicated": Requirements expressed by graphic representations or in written form on Drawings, in Specifications, and in other Contract Documents. Other terms including "shown," "noted," "scheduled," and "specified" have the same meaning as "indicated."
- F. "Regulations": Laws, ordinances, statutes, and lawful orders issued by authorities having jurisdiction, and rules, conventions, and agreements within the construction industry that control performance of the Work.
- G. "Furnish": Supply and deliver to Project site, ready for unloading, unpacking, assembly, installation, and similar operations.
- H. "Install": Operations at Project site including unloading, temporarily storing, unpacking, assembling, erecting, placing, anchoring, applying, working to dimension, finishing, curing, protecting, cleaning, and similar operations.
- I. "Provide": Furnish and install, complete and ready for the intended use.
- J. "Project Site": Space available for performing construction activities. The extent of Project site is shown on Drawings and may or may not be identical with the description of the land on which Project is to be built.

1.3 INDUSTRY STANDARDS

- A. Applicability of Standards: Unless the Contract Documents include more stringent requirements, applicable construction industry standards have the same force and effect as if

SECTION 014200 - REFERENCES

bound or copied directly into the Contract Documents to the extent referenced. Such standards are made a part of the Contract Documents by reference.

- B. Publication Dates: Comply with standards in effect as of date of the Contract Documents unless otherwise indicated.
- C. Copies of Standards: Each entity engaged in construction on Project should be familiar with industry standards applicable to its construction activity. Copies of applicable standards are not bound with the Contract Documents.
 - 1. Where copies of standards are needed to perform a required construction activity, obtain copies directly from publication source.

1.4 ABBREVIATIONS AND ACRONYMS

- A. Industry Organizations: Where abbreviations and acronyms are used in Specifications or other Contract Documents, they shall mean the recognized name of the entities indicated in Thomson Gale's "Encyclopedia of Associations" or in Columbia Books' "National Trade & Professional Associations of the U.S."
- B. Code Agencies: Where abbreviations and acronyms are used in Specifications or other Contract Documents, they shall mean the recognized name of the entities in the following list. Names, telephone numbers, and Web sites are subject to change and are believed to be accurate and up-to-date as of the date of the Contract Documents.
- C. Federal Government Agencies: Where abbreviations and acronyms are used in Specifications or other Contract Documents, they shall mean the recognized name of the entities in the following list. Names, telephone numbers, and Web sites are subject to change and are believed to be accurate and up-to-date as of the date of the Contract Documents.
- D. Standards and Regulations: Where abbreviations and acronyms are used in Specifications or other Contract Documents, they shall mean the recognized name of the standards and regulations in the following list. Names, telephone numbers, and Web sites are subject to change and are believed to be accurate and up-to-date as of the date of the Contract Documents.
- E. State Government Agencies: Where abbreviations and acronyms are used in Specifications or other Contract Documents, they shall mean the recognized name of the entities in the following list. Names, telephone numbers, and Web sites are subject to change and are believed to be accurate and up-to-date as of the date of the Contract Documents.

PART 2 - PRODUCTS (Not Used)

PART 3 - EXECUTION (Not Used)

END OF SECTION

SECTION 015000 - TEMPORARY FACILITIES AND CONTROLS

PART 1 - GENERAL

1.1 RELATED DOCUMENTS

- A. Drawings and general provisions of the Contract, including General and Supplementary Conditions and other Division 01 Specification Sections, apply to this Section.

1.2 SUMMARY

- A. Section includes requirements for temporary utilities, support facilities, and security and protection facilities.
- B. Related Requirements:
 - 1. Section 011000 "Summary" for work restrictions and limitations on utility interruptions.

1.3 USE CHARGES

- A. General: Installation and removal of and use charges for temporary facilities shall be included in the Contract Sum unless otherwise indicated. Allow other entities to use temporary services and facilities without cost, including, but not limited to, Architect, occupants of Project, testing agencies, and authorities having jurisdiction.
- B. Electric Power Service: Contractor shall provide power for construction operations and temporary facilities. Contractor responsible for cost of power until final completion of Project.
- C. Water and Sewer Service: Contractor shall provide water and sewer service for construction operations and temporary facilities. Contractor responsible for cost of water and sewer service until final completion of Project.
- D. Fuel: Contractor shall provide temporary heat as required for construction operations and temporary facilities. Contractor responsible for fuel cost associated all construction operations and use of temporary facilities.

1.4 SUBMITTALS

- A. Site Plan: Provide a site plan that shows locations of temporary facilities, utility connections, staging areas, and parking areas for construction personnel. Should construction sequencing or phasing alter the locations of the above, then secondary plans showing revised locations are required. Coordinate this site plan with the Contract Drawings.

1.5 QUALITY ASSURANCE

- A. Electric Service: Comply with NECA, NEMA, and UL standards and regulations for temporary electric service. Install service to comply with NFPA 70.

SECTION 015000 - TEMPORARY FACILITIES AND CONTROLS

- B. Tests, Permits, & Inspections: Obtain required permits, tests, and inspections from authorities having jurisdiction for each temporary utility prior to use.

1.6 PROJECT CONDITIONS

- A. Temporary Use of Permanent Facilities: Installer of each permanent service shall assume responsibility for operation, maintenance, and protection of each permanent service during its use as a construction facility before Owner's acceptance, regardless of previously assigned responsibilities.

PART 2 - PRODUCTS

2.1 MATERIALS

- A. Portable Chain-Link Fencing: Minimum 2-inch, 0.148-inch- thick, galvanized-steel, chain-link fabric fencing; minimum 6 feet high with galvanized-steel pipe posts; minimum 2-3/8-inch- OD line posts and 2-7/8-inch- OD corner and pull posts, with 1-5/8-inch- OD top and bottom rails. Provide galvanized-steel bases for supporting posts.

2.2 EQUIPMENT

- A. Fire Extinguishers: Portable, UL rated; with class and extinguishing agent as required by locations and classes of fire exposures.
- B. HVAC Equipment: Unless Owner authorizes use of permanent HVAC system, provide vented, self-contained, liquid-propane-gas or fuel-oil heaters with individual space thermostatic control.
 - 1. Use of gasoline-burning space heaters, open-flame heaters, or salamander-type heating units is prohibited.
 - 2. Heating Units: Listed and labeled for type of fuel being consumed, by a qualified testing agency acceptable to authorities having jurisdiction, and marked for intended location and application.
 - 3. Permanent HVAC System: Use of permanent HVAC systems during construction is prohibited. Isolated short term use can occur if approved in writing by the Owners representative. If Owner authorizes use of permanent HVAC system for temporary use during construction, provide filter with MERV of 8 at each return-air grille in system and remove at end of construction and clean HVAC system as required in Section 017700 "Closeout Procedures".
- C. Air-Filtration Units: Primary and secondary HEPA-filter-equipped portable units with four-stage filtration. Provide single switch for emergency shutoff. Configure to run continuously.

SECTION 015000 - TEMPORARY FACILITIES AND CONTROLS

PART 3 - EXECUTION

3.1 INSTALLATION, GENERAL

- A. Locate facilities where they will serve Project adequately and result in minimum interference with performance of the Work. Relocate and modify facilities as required by progress of the Work.

3.2 TEMPORARY UTILITY INSTALLATION

- A. General: Install temporary service or connect to existing service.
 - 1. Arrange with utility company, Owner, and existing users for time when service can be interrupted, if necessary, to make connections for temporary services.
- B. Sewers and Drainage: Provide temporary utilities to remove effluent lawfully.
 - 1. Connect temporary sewers to municipal system as directed by authorities having jurisdiction.
- C. Water Service: Install water service and distribution piping in sizes and pressures adequate for construction.
- D. Sanitary Facilities: Provide temporary toilets, wash facilities, and drinking water for use of construction personnel. Comply with authorities having jurisdiction for type, number, location, operation, and maintenance of fixtures and facilities. Provide hot and cold water to all sanitary facilities.
- E. Heating and Cooling: Provide temporary heating and cooling required by construction activities for curing or drying of completed installations or for protecting installed construction from adverse effects of low temperatures or high humidity. Select equipment that will not have a harmful effect on completed installations or elements being installed.
- F. Ventilation and Humidity Control: Provide temporary ventilation required by construction activities for curing or drying of completed installations or for protecting installed construction from adverse effects of high humidity. Select equipment that will not have a harmful effect on completed installations or elements being installed. Coordinate ventilation requirements to produce ambient condition required and minimize energy consumption.
- G. Electric Power Service: Provide electric power service and distribution system of sufficient size, capacity, and power characteristics required for construction operations.
- H. Lighting: Provide temporary lighting with local switching that provides adequate illumination for construction operations, observations, inspections, and traffic conditions.
 - 1. Install and operate temporary lighting that fulfills security and protection requirements without operating entire system.

SECTION 015000 - TEMPORARY FACILITIES AND CONTROLS

3.3 SUPPORT FACILITIES INSTALLATION

- A. General: Comply with the following:
 - 1. Maintain support facilities until Architect schedules Substantial Completion inspection. Remove before Substantial Completion. Personnel remaining after Substantial Completion will be permitted to use permanent facilities, under conditions acceptable to Owner.
- B. Traffic Controls: Comply with requirements of authorities having jurisdiction.
 - 1. Maintain access for fire-fighting equipment and access to fire hydrants.
- C. Parking: Limit parking to areas designated as contractor staging areas.
- D. Waste Disposal Facilities: Provide waste-collection containers in sizes adequate to handle waste from construction operations. Comply with requirements of authorities having jurisdiction. Comply with progress cleaning requirements in Section 017300 "Execution."

3.4 SECURITY AND PROTECTION FACILITIES INSTALLATION

- A. Environmental Protection: Comply with requirements specified in Division 31 Section "Temporary Environmental Controls."
 - 1. Comply with work restrictions specified in Division 1 Section "Summary."
- B. Temporary Erosion and Sedimentation Control: Comply with requirements specified in Division 31 Section "Erosion Control."
- C. Stormwater Control: Comply with authorities having jurisdiction. Provide barriers in and around excavations and subgrade construction to prevent flooding by runoff of stormwater from heavy rains.
- D. Site Enclosure Fence: Before construction operations begin, furnish and install site enclosure fence in a manner that will prevent people and animals from easily entering site except by entrance gates.
 - 1. Extent of Fence: As shown on construction drawings and/or surrounding Contractor staging areas to provide separation from those areas and public spaces.
- E. Security Enclosure and Lockup: Install substantial temporary enclosure around partially completed areas of construction. Provide lockable entrances to prevent unauthorized entrance, vandalism, theft, and similar violations of security.
- F. Barricades, Warning Signs, and Lights: Comply with requirements of authorities having jurisdiction for erecting structurally adequate barricades, including warning signs and lighting.
- G. Temporary Enclosures: Provide temporary enclosures for protection of construction, in progress and completed, from exposure, foul weather, other construction operations, and similar activities. Provide temporary weathertight enclosure for building exterior.

SECTION 015000 - TEMPORARY FACILITIES AND CONTROLS

1. Where heating or cooling is needed and permanent enclosure is not complete, insulate temporary enclosures.
- H. Temporary Fire Protection: Install and maintain temporary fire-protection facilities of types needed to protect against reasonably predictable and controllable fire losses. Comply with NFPA 241.
1. Prohibit smoking in construction areas.
 2. Supervise welding operations, combustion-type temporary heating units, and similar sources of fire ignition according to requirements of authorities having jurisdiction.
 3. Develop and supervise an overall fire-prevention and -protection program for personnel at Project site. Review needs with local fire department and establish procedures to be followed. Instruct personnel in methods and procedures. Post warnings and information.
 4. Provide temporary standpipes and hoses for fire protection. Hang hoses with a warning sign stating that hoses are for fire-protection purposes only and are not to be removed. Match hose size with outlet size and equip with suitable nozzles.
- I. Protection of Existing Facilities: Protect existing, equipment, structures, utilities, and other improvements at Project site and on adjacent properties, except those indicated to be removed or altered. Repair damage to existing facilities.

3.5 MOISTURE AND MOLD CONTROL

- A. Contractor's Moisture-Protection Plan: Avoid trapping water in finished work. Document visible signs of mold that may appear during construction.
- B. Exposed Construction Phase: Before installation of weather barriers, when materials are subject to wetting and exposure and to airborne mold spores, protect as follows:
1. Protect porous materials from water damage.
 2. Protect stored and installed material from flowing or standing water.
 3. Keep porous and organic materials from coming into prolonged contact with concrete.
 4. Remove standing water from decks.
 5. Keep deck openings covered or dammed.

3.6 OPERATION, TERMINATION, AND REMOVAL

- A. Supervision: Enforce strict discipline in use of temporary facilities. To minimize waste and abuse, limit availability of temporary facilities to essential and intended uses.
- B. Maintenance: Maintain facilities in good operating condition until removal.
1. Maintain operation of temporary enclosures, heating, cooling, humidity control, ventilation, and similar facilities on a 24-hour basis where required to achieve indicated results and to avoid possibility of damage.
 2. Maintain Owner's onsite field office as required to allow full use of the facility for the duration of the project.
- C. Temporary Facility Changeover: Do not change over from using temporary security and protection facilities to permanent facilities until Substantial Completion.

SECTION 015000 - TEMPORARY FACILITIES AND CONTROLS

- D. Termination and Removal: Remove each temporary facility when need for its service has ended, when it has been replaced by authorized use of a permanent facility, or no later than Substantial Completion. Complete or, if necessary, restore permanent construction that may have been delayed because of interference with temporary facility. Repair damaged Work, clean exposed surfaces, and replace construction that cannot be satisfactorily repaired.
1. Materials and facilities that constitute temporary facilities are property of Contractor. Owner reserves right to take possession of Project identification signs.
 2. At Substantial Completion, repair, renovate, and clean permanent facilities used during construction period. Comply with final cleaning requirements specified in Section 017700 "Closeout Procedures."

END OF SECTION

SECTION 015220 - SECURITY

PART 1 – GENERAL

1.1 SECURITY PROGRAM

A. The CONTRACTOR shall:

1. Protect WORK, existing premises, and Using Agency's operations from theft, vandalism, unauthorized entry, and unauthorized exiting from secure areas.
2. Initiate security efforts in coordination with Using Agency's existing security program at initialization of Project mobilization.
3. Maintain security efforts throughout construction period until Final Completion.

1.2 PERSONNEL IDENTIFICATION

A. At the discretion of the OWNER, the CONTRACTOR shall:

1. Require each person authorized to enter premises to possess and visibly display an identification card.
2. Require return of cards from all individuals when they are no longer involved with WORK at the Project site.

B. Identification cards shall be provided by the Using Agency and will include personal photograph; name, title and employer, and assigned number. Identification cards will be issued only after each individual has completed a special training program administered by Bartlett Regional Hospital. The program is anticipated to take less than one hour, but is mandatory. All personnel performing work in the BRH main building will be required to comply with Section 015221C – Personnel Immunization Requirements.

1.3 RESTRICTIONS

A. All personnel employed on the Project site by the CONTRACTOR, Subcontractors, Suppliers, installers and other entities engaged in WORK shall strictly adhere to the security, safety, confidentiality, and hospital compliance program requirements depicted in Section 015221A – Special Safety Requirements (ICRA), Section 015221 B – ICRA Policies, and Section 15221 C – Personnel Immunization Requirements.

PART 2 - PRODUCTS (Not Used)

PART 3 - EXECUTION (Not Used)

END OF SECTION 015220

SECTION 015221A – SPECIAL SAFETY REQUIREMENTS

PART 1 – GENERAL

1.1 SAFETY PROGRAM

A. General:

1. The safety of bidders, the CONTRACTOR, their work forces in total, the USING AGENCY's personnel, patients and the public is a major concern of the OWNER and the PROJECT MANAGER. To ensure Project and campus wide safety, the CONTRACTOR shall carefully adhere to the requirements outlined within this section and within any attached BRH policies.
2. CONTRACTOR shall employ a safety program to insure that CONTRACTOR's personnel and all personnel of the Subcontractors, Suppliers, Installers and material workers are trained and kept abreast of hospital safety requirements. In addition to the safety requirements enforced by code or jurisdictional entities, the CONTRACTOR's safety program shall also address fire safety and deployment plans for the Project site, response to accidental release of hazardous materials, breach of infection containment barriers, and general emergency response.
3. CONTRACTOR's safety program will be provided to the PROJECT MANAGER, in writing, prior to commencement of WORK. Plans shall be periodically revised in response to issues that may arise during the course of the WORK. Such revisions shall be provided promptly to the PROJECT MANAGER.

B. The CONTRACTOR shall;

1. Abide by all applicable safety practices and requirements, irrespective of their origins.
2. Attend safety related meetings as may be required by the OWNER or PROJECT MANAGER.
3. CONTRACTOR shall employ a safety program to insure that CONTRACTOR's personnel and all personnel of the Subcontractors, Suppliers, Installers and material workers are trained and kept abreast of hospital safety requirements. Maintain program throughout construction period until Final Completion.

1.2 SAFETY STANDARDS

- A. Applicable safety related standards promulgated by safety or code enforcement agencies, such as but not limited to; AK-DEC, OSHA, Building Officials and Fire Marshal's Office representatives.
- B. Safety/guidelines and policies established by the Department of Infection Control/Safety/Facilities of Bartlett Regional Hospital covering Infection Control for Construction and Renovation. (See BRH Policy at the end of this section.)
- C. Safety guidelines and policies established by Bartlett Regional Hospital covering Interim Life Safety Plan. (See BRH Policy at the end of this section.)
- D. Safety Requirements required by the Contract Documents.

SECTION 015221A – SPECIAL SAFETY REQUIREMENTS

1.3 SAFETY PROCEDURES

- A. In addition to devices required by safety or code enforcement agencies, the CONTRACTOR shall employ safety and containment devices (barricades, temporary separation/isolation walls, temporary directional signage, warning signs, etc.) at all locations where the public, patients or hospital staff may have access to, or mistakenly venture into, an area of active construction or an area where material / equipment items may be stored or staged. The PROJECT MANAGER will have the final determination as to the locations and the extent of the required safety containment devices and temporary directional / warning signage.
- B. As determined by the PROJECT MANAGER, and where conditions necessitate the construction of temporary exit routes or temporary exit detours, the CONTRACTOR shall develop and/or construct such routes to the standards of the Contract Documents, or the enforcement agency. The CONTRACTOR shall provide and post temporary directional and warning signs at all temporary exit routes. Such routes and all temporary signage shall be approved by the PROJECT MANAGER prior to putting them into use.
- C. Temporary signage shall consist of pre-printed 8-1/2x11 inch standard paper stock attached to walls or doors with removable painters tape. No tacks, pins or staples are to be used in conjunction with any temporary signage.
- D. CONTRACTOR shall not remove, block or otherwise obscure any of the existing permanent directional signage without specific written direction by the PROJECT MANAGER. CONTRACTOR shall cooperate with and assist the USING AGENCY in the establishment and maintenance of temporary “user oriented” direction signage.
- E. Permanent directional signage that has been disrupted or damaged during the course of construction shall be immediately repaired or replaced by the CONTRACTOR.

1.4 SECURITY SERVICE

- A. The CONTRACTOR shall;
 - 1. Provide all security personnel and programs as described in Specification Section 015220 – Security.
 - 2. Cooperate with the USING AGENCY, the security forces employed by the USING AGENCY and the PROJECT MANAGER to insure the security and safety of the Project, the public, patients and BRH staff, and all other facilities on the hospital campus.

SECTION 015221A – SPECIAL SAFETY REQUIREMENTS

1.5 RESTRICTIONS WITHIN ACTIVE CONSTRUCTION AREAS

- A. All personnel employed on the Project site by the CONTRACTOR, Subcontractors, Suppliers, installers and other entities engaged in WORK shall strictly adhere to the security, safety, confidentiality, and hospital compliance program requirements depicted within this section.

1.6 INFECTION CONTROL MEASURES

- A. The CONTRACTOR shall comply with the Infection Risk Control Assessment (ICRA): Infection Control for Construction and Renovation Policy and requirements set forth in Section 015221B.
- B. The CONTRACTOR shall complete and comply with the Personnel Immunization Requirements forms in Section 015221C.
- C. The CONTRACTOR shall comply with all current COVID-19 health mandates implemented by the State of Alaska and City and Borough of Juneau, and all BRH policies related to COVID-19 as set forth in Section 015221B.

PART 2 - PRODUCTS (Not Used)

PART 3 - EXECUTION (Not Used)

END OF SECTION 015221A

SECTION 015221B – ICRA INFECTION CONTROL FOR CONSTRUCTION AND RENOVATION

Bartlett Regional Hospital

Title: **ICRA: INFECTION CONTROL FOR CONSTRUCTION AND RENOVATION**

Department: Infection Control/Safety/Facilities

Original Date: 07-02

Author: Infection Control

PURPOSE:

To establish a process for the identification and reduction of risk from airborne transmission of infectious agents during construction, demolition, renovation, and repair on the Bartlett Regional Hospital Campus.

DEFINITIONS:

- A. **ICRA:** Infection Control Risk Assessment. Analysis of a construction, demolition, or renovation project to establish infection risk and control by a multidisciplinary group designated for that purpose.
- B. **Infection Control Permit:** A permit issued by Infection Control for construction and renovation projects that are Class III or above as determined by the Infection Control Risk Group Matrix. (in the Infection Control Risk Assessment Packet, Appendix C)
- C. **ICRAC:** Infection Control Risk Assessment Committee. An ad hoc subcommittee of the BRH Infection Control Committee tasked with development, oversight, and enforcement of this policy.
- D. **HEPA Filter:** High efficiency particulate air filters. (99% of 0.3-micron size particles)
- E. **HVAC:** Heating, Ventilation, Air-conditioning. (Air-handling unit.)
- F. **CRP:** Construction and Renovation Policy. (This policy.)

POLICY:

- A. An Infection Control Risk Assessment (ICRA) will be performed for every construction, demolition, and renovation project on the BRH campus, including site work (utilities, landscaping, etc.) even when no building is being constructed or renovated.
- B. Bartlett Regional Hospital requires any subcontractor, sub-subcontractor, vendor, employee, or agent to be bound by these requirements. Before any demolition or construction on-site begins, the contractor and contractor's employees will attend mandatory training sessions provided by a Bartlett Regional Hospital Safety or Infection Control representative. Course objectives will be distributed at class.
- C. An Infection Control Permit (see the Infection Control Risk Assessment Packet Appendix C) will be issued by the ICRAC and posted at the work-site as appropriate for the duration of the project, as indicated by the ICRA.
- D. Changes to the ICRA may be made by the ICRAC at any time during the project. Changes will be communicated to the Construction Manager or designee.

SECTION 015221B – ICRA INFECTION CONTROL FOR CONSTRUCTION AND RENOVATION

- E. Bartlett Regional Hospital’s Safety Officer or the ICRAC may modify performance requirements for certain activities. A modification made by BRH personnel does not relieve the contractor of compliance with proper infection control procedures.
- F. When required by the Infection Control Permit, HEPA equipped filtration machines shall provide air flow into construction area not less than 100 FPM at barricade entrances with doors fully open. HEPA equipped air filtration machines shall be connected to normal power and ganged to a single switch for emergency shutoff and shall run continuously. In the event of a power failure and no back-up power is immediately available, work will be stopped until power becomes available.
- G. Documentation of the ICRA process will be maintained by the Construction Manager or designee.
- H. Regular reports will be provided to the Infection Control Committee by a representative of the ICRAC.
- I. All project personnel are required to comply with current BRH policies regarding the COVID-19 virus, as well as all State of Alaska health mandates and City and Borough of Juneau ordinances related to COVID-19. Health mandates, ordinances and policies may change during the construction period.

PROCEDURES:

A. Responsibilities During Project Planning

- A.1. An interdisciplinary team including architects, construction managers, contractors, department personnel, the Infection Control Coordinator, and Safety Officer will evaluate any construction project from design through completion for infection control concerns.
- A.2. The Infection Control Coordinator will be involved in the design phase of any project. The design and function considerations for infection control are listed in Appendix A. These considerations are for the duration of the project, as well as considerations for the infection control issues for the finished project. The Construction Manager or designee will contact the Infection Control Coordinator for obtaining input on the project.
- A.3. Each project will have an Infection Control Risk Assessment (ICRA) performed during the planning phase of the project. Projects in Class III, III/IV, or IV require an Infection Control Permit to be posted at the site for the duration of the project. (Appendix C)
- A.4. Construction measures required by the ICRA will be communicated to the contractors by the Construction Manager or designee during the bidding phase of the project. All contractors and contract construction personnel be responsible for maintaining and complying with the general and class specific infection control and safety practices for the project.

B. Responsibilities During the Active Construction Phase

- B.1. The Construction Manager or designee will perform a Safety and Infection Control Risk Assessment for every day that there is work on the site (Appendix B). Unsafe conditions will be corrected immediately and corrections documented on the form. The Construction Manager or designee is responsible for oversight and documentation of this process.

SECTION 015221B – ICRA INFECTION CONTROL FOR CONSTRUCTION AND RENOVATION

- B.2. As a quality control measure, a member of the ICRAAC will review monitoring reports compiled by the Project Manager for each project of Class III or greater. The ICRAAC will receive updates via written reports, emails, or meetings as circumstances warrant. The Construction Manager or designee will be notified immediately to correct any unsafe conditions.
- B.3. The contractor shall be required to take immediate action to correct all deficiencies.
- B.4. The ICRAAC has the authority to stop construction for any breach in the infection control practices, or for any patient safety concern related to infection and construction. This will be done through the Construction Manager or designee.
- B.5. Failure of the contractor to promptly correct such deficiencies will result in corrective action taken by CBJ and BRH Construction Management per project documents.
- B.6. The Contractor will notify the Construction Manager or designee for any assistance with medical waste, work in negative pressure areas, or any concerns involving patients or patient care areas.

C. General Infection Control Practices for All Construction and Renovation Projects

- C.1. Construction activities causing disturbance of existing dust, or creating new dust, must be conducted in tight enclosures cutting off any flow of particles into patient areas.
- C.2. Construction areas will have dust mops, wet mops, brooms, buckets, and clean rags for wiping fine dust from floors and surfaces in adjacent areas.
- C.3. Walk-off (sticky) mats shall be used outside of every construction entrance. Any dust outside the barrier shall be cleaned up immediately using a HEPA-filtered vacuum or wet mop.
- C.4. Debris from the construction site will be removed with carts that are covered in a manner that does not allow the escape of dust.
- C.5. Any ceiling tiles that are moved (even for visualization) outside of the construction barrier will be replaced immediately when unattended.
- C.6. Barriers
 - C.6.1. Closed door with masking tape applied over the frame and door is acceptable for projects that can be contained within a single room.
 - C.6.2. Construction, demolition or reconstruction not capable of containment within a single room must have the following barriers erected:
 - C.6.2.1. Small, short duration projects generating minimal dust may use fire-rated plastic sheeting that extends from floor to ceiling. Seams must be sealed with tape to prevent dust and debris from escaping and have at least 2-foot overlapping flaps for access to entry.
 - C.6.2.2. Any project generating moderate to high levels of dust or of more than short duration must require rigid dust-proof, and fire-rated barrier walls (e.g. drywall) with caulked seams. An interim plastic dust barrier may be required to protect the area while the rigid impervious barrier is being constructed.
 - C.6.2.3. Barriers are required at penetrations of ceiling envelopes, chases and ceiling spaces to stop movement of air and debris.
 - C.6.2.4. Large dusty projects require an anteroom or double entrance vestibule for workers to remove protective clothing or vacuum off existing clothing.
- C.7. HEPA-filtered negative pressure units will be run continually during the course of the project (24 hours per day).

D. Performing An Infection Control Risk Assessment

SECTION 015221B – ICRA INFECTION CONTROL FOR CONSTRUCTION AND RENOVATION

- D.1. Each project will have an Infection Control Risk Assessment done during the programming phase of the project. The results will be communicated with the architect and contractor. (See ICRA Packet, Appendix C).
- D.2. Class III and higher projects require an Infection Control Permit before construction begins. (ICRA Packet, Appendix C)

REFERENCES:

Bartley, J., ed. (1999). APIC Infection Control Toolkit Series: Construction and Renovation. Washington, DC: Association for Professionals in Infection Control and Epidemiology, Inc.

Centers for Disease Control and Prevention, Healthcare Infection Control Practices Advisory Committee. (2001). Draft Guideline for Environmental Infection Control in Healthcare Facilities.

Comprehensive Manual on Accreditation of Hospitals (2001). Oakbrook, IL.: Joint Commission on Accreditation of Hospitals and Healthcare Organizations: 2001.

Davis, S. (2001). “Don’t Wait for Dust to Settle on Patient Risk.” In Environment of Care Leader (6) 11. (May 21, 2001).

Approval/Review/Revision					
Date:	Signature:	Date:	Signature:	Date:	Signature:
11/1/02	Dr. Hunter-Joerns				
8/3/04	Dr. Hunter-Joerns				
2/07/06	Dr. Hunter-Joerns				
2/21/08	Dr. Hunter-Joerns				
8/2/11	Dr. Hunter-Joerns				

**SECTION 015221B – ICRA INFECTION CONTROL FOR CONSTRUCTION AND
RENOVATION**

APPENDIX A:

Construction Design and Function Considerations for Environmental Infection Control

- A. Location of sinks and handwashing product dispensers.
- B. Types of faucets (aerated vs. non-aerated, and type of faucet e.g. wrist blades, knee, foot, or infrared controlled).
- C. Air-handling systems engineered for optimal performance and easy maintenance and repair.
- D. Air changes per hour (ACH) and pressure differentials to accommodate special patient care areas.
- E. Location of fixed sharps containers.
- F. Types of surface finishes (non-porous vs. porous).
- G. Well-caulked wall with minimal seams.
- H. Location of adequate storage and supply areas.
- I. Appropriate location of medicine preparation areas (e.g. >3ft. from a sink).
- J. Appropriate location and type of ice machines.
- K. Appropriate materials for sinks and wall coverings.
- L. Appropriate traffic flow (no “dirty” movement through “clean” areas).
- M. Isolation rooms with anterooms as required.
- N. Appropriate flooring (e.g. seamless floors in dialysis units).
- O. Sensible use of carpeting (e.g. no carpeting in special care areas or areas likely to become wet.)
- P. Properly engineered areas for linen services and solid waste management.
- Q. Location of main generator to minimize risk of system failure from flooding or other emergency.
- R. Installation guidelines for gypsum wallboard.

From: Centers for Disease Control (2001) Guidelines for Environmental Infection Control in Healthcare Facilities (draft).

SECTION 015221B – ICRA INFECTION CONTROL FOR CONSTRUCTION AND RENOVATION

APPENDIX B:

Safety and Infection Control Risk Assessment Tool

Project: BRH-Endoscopy Ventilation and Electrical Upgrades Date _____ Time _____

DAILY INFECTION CONTROL MONITOR:

Standard	Yes	No	Corrected? / Comments
A. Construction Barricades:			
Barricades sealed, no penetrations			
Walk-off mats at all exits			
Barricade doors have closers			
Door frames gasketed, close and seal properly			
Adjacent ceiling areas intact			
Adjacent floors clean, no dust tracked			
B. Negative Air:			
Negative pressure at barricade entrance			
All windows and doors closed behind barricade			
Negative air machines running, filters clean, discharge hoses intact			
Demonstrated use of appropriate equipment to prevent airborne particulate matter: this includes HEPA filtration units, HEPA vacuum equipment, and continuous use of exhaust fans			
No construction activity within 25 feet of existing fresh air intake			
C. Jobsite:			
Project area clean, debris removed daily			
Debris removed in suitable closed containers			
No signs of pests			
No signs of water leakage			
D. Occupied Areas:			
Work authorized and scheduled			
Sheet plastic barricade in place and properly sealed			
Surrounding area clean			
Patient care equipment and supplies removed from construction area			
Ceiling tiles replaced when not being accessed (if occupied area, adjacent patient doors are closed)			

SECTION 015221B – ICRA INFECTION CONTROL FOR CONSTRUCTION AND RENOVATION

DAILY SAFETY MONITOR:

Standard	Yes	No	Corrected? / Comments
A. General Safety:			
Contract workers wearing required identification			
Construction personnel wearing required PPE (e.g. hardhat, goggles, coveralls, etc.)			
Construction area secure (e.g. barriers adequate to prevent entry of unauthorized persons)			
Construction personnel following safe work practices (e.g. ladder safety, no smoking, trip and fall hazards, etc.)			
Power secured at end of each day			
Extension cords grounded, in good condition			
B. Exits			
Exits provide free and unobstructed access			
Alternate egress established and workers received training			
Negative air machines running, filters clean, discharge hoses intact			
C. Fire Equipment:			
Fire alarms, detection, and suppression systems operational			
Additional fire equipment and training provided for personnel			
D. Fire Safety:			
No smoking policy implemented			
Minimum of two fire drills per shift per quarter			
Area free of storage, housekeeping materials, food waste, and debris to reduce flammable and combustible fire load of building			

Additional comments and observations: _____

Inspector Signature: _____

APPENDIX C

SECTION 015221B – ICRA INFECTION CONTROL FOR CONSTRUCTION AND
RENOVATION

**INFECTION CONTROL
RISK ASSESSMENT
PACKET**

An Infection Control Risk Assessment (ICRA) will be performed by the Construction Manager or designee for every construction, demolition, and renovation project on the Bartlett Regional Hospital campus, including site work (utilities, landscaping, etc.) even when no building is being constructed or renovated.

1. Step #1: Using the following table, determine the type of construction activity and *circle* Type A, B, C, or D.:

The construction activity types are defined by the amount of dust generated, the duration of the activity, and the amount of shared HVAC systems.

Contact Infection Control if any activity is questionable under these guidelines.

SECTION 015221B – ICRA INFECTION CONTROL FOR CONSTRUCTION AND RENOVATION

Circle one **Type** below:

Type A	<p>Inspection and Non-Invasive Activities Includes, but is not limited to:</p> <ul style="list-style-type: none"> <input type="checkbox"/> removal of ceiling tiles for visual inspection limited to 1 tile per 50 square feet <input type="checkbox"/> painting (but not sanding) <input type="checkbox"/> wall covering, electrical trim work, minor plumbing, and activities which do not generate dust or require cutting of walls or access to ceilings other than for visual inspection
Type B	<p>Small Scale, Short Duration Activities Which Create Minimal Dust Includes, but is not limited to:</p> <ul style="list-style-type: none"> <input type="checkbox"/> installation of telephone and computer cabling <input type="checkbox"/> access to chase spaces <input type="checkbox"/> cutting of walls or ceiling where dust migration can be controlled
Type C	<p>Work That Generates a Moderate to High Level of Dust or Requires Demolition or Removal of Any Fixed Building Components or Assemblies Includes, but is not limited to:</p> <ul style="list-style-type: none"> <input type="checkbox"/> sanding of walls for painting or wall covering <input type="checkbox"/> removal of floor coverings, ceiling tiles and casework <input type="checkbox"/> new wall construction <input type="checkbox"/> minor duct work or electrical work above ceilings <input type="checkbox"/> major cabling activities <input type="checkbox"/> any activity which cannot be completed within a single workshif
Type D	<p>Major Demolition and Construction Projects Includes, but is not limited to:</p> <ul style="list-style-type: none"> <input type="checkbox"/> activities that require consecutive work shifts <input type="checkbox"/> requires heavy demolition or removal of a complete cabling system <input type="checkbox"/> new construction

SECTION 015221B – ICRA INFECTION CONTROL FOR CONSTRUCTION AND RENOVATION

2. Step # 2.: Using the following table, identify the Infection Control Risk Group or Groups that will be affected by the construction activity, and *circle* Group 1, 2, 3, or 4.

*Circle the appropriate **Risk Group(s)** below:

Group 1 Low Risk	Group 2 Medium Risk	Group 3 High Risk	Group 4 Highest Risk
<input type="checkbox"/> Office Areas <input type="checkbox"/> Public Areas (except when associated with a higher risk area) <input type="checkbox"/> All other non-patient work areas (e.g. facilities, stores) <input type="checkbox"/> Behavioral Health Units	<input type="checkbox"/> Cafeteria <input type="checkbox"/> Patient care areas, inpatient and outpatient, except as noted in Groups 3 and 4.	<input type="checkbox"/> Emergency Department <input type="checkbox"/> Radiology <input type="checkbox"/> PACU <input type="checkbox"/> Same Day Surgery <input type="checkbox"/> Laboratory <input type="checkbox"/> Kitchen <input type="checkbox"/> Obstetrics <input type="checkbox"/> Newborn Nursery <input type="checkbox"/> Pharmacy <input type="checkbox"/> PT: Tub and Treatment Rooms	<input type="checkbox"/> Critical Care Unit <input type="checkbox"/> Special Care Nursery <input type="checkbox"/> Operating Rooms, including C-Section Rooms <input type="checkbox"/> Central Sterile Supply <input type="checkbox"/> Endoscopy <input type="checkbox"/> Infusion Therapy <input type="checkbox"/> Pharmacy Admixture <input type="checkbox"/> Negative Pressure Isolation Rooms

3. Step # 3: Determine the Level of Infection Control Activity required by *matching* the Construction Type with the Risk Level using the matrix below.

Circle one **Class** below:

Construction Activity-Infection Control Matrix				
Construction Activity				
Risk Level	Type A	Type B	Type C	Type D
Group 1	I	II	II	III/IV
Group 2	I	II	III	IV
Group 3	I	II	III/IV	IV

SECTION 015221B – ICRA INFECTION CONTROL FOR CONSTRUCTION AND RENOVATION

Group 4	II	III/IV	III/IV	IV
----------------	----	--------	--------	----

4. Step # 4. Obtain an Infection Control Permit:

- An Infection Control Permit and approval will be required when the Construction Activity and Risk Level indicate Class III or higher (shaded areas).
- This permit will remain posted at the worksite for the duration of the project.
- This permit will be returned to the Construction Manager or designee at the completion of the project.

5. Step # 5. Identify Areas Surrounding Project Area

Identify the **areas** surrounding the project area, assessing potential impact. *

Identify Unit Below	Identify Unit Above	Identify Lateral Unit	Identify Lateral Unit	Identify Unit Behind	Identify Unit Front
Identify Risk Group: 1 2 3 4	Identify Risk Group: 1 2 3 4	Identify Risk Group: 1 2 3 4	Identify Risk Group: 1 2 3 4	Identify Risk Group: 1 2 3 4	Identify Risk Group: 1 2 3 4
Potential Impact? Yes___ No___	Potential Impact? Yes___ No___	Potential Impact? Yes___ No___	Potential Impact? Yes___ No___	Potential Impact? Yes___ No___	Potential Impact? Yes___ No___
See comments	See comments	See comments	See comments	See comments	See comments

Comments*

*note:

Another aspect of “Areas Surrounding Project Area” are any nearby buildings where patients are present that could be in the path of blown dust coming from building demolition, excavation, foundation construction, and site work

6. Step # 6. Identify specific site of activity, e.g.: patient rooms, medication room, etc._____

7. Step # 7. Work hours: Can or will the work be done during non-patient care hours?

Yes _____ No _____ Not applicable _____
Other _____

SECTION 015221B – ICRA INFECTION CONTROL FOR CONSTRUCTION AND RENOVATION

Infection Control Permit

Bartlett Regional Hospital Infection Control Construction Permit						
						Permit No:
Location of Construction:				Project Start Date:		
Project Coordinator				Estimated Duration:		
Contractor Performing Work				Permit Expiration Date:		
Supervisor:				Telephone:		
YES	NO	CONSTRUCTION ACTIVITY		YES	NO	INFECTION CONTROL RISK GROUP
		TYPE A: Inspection, non-invasive activity				GROUP 1: Least Risk
		TYPE B: Small scale, short duration, moderate to high levels				GROUP 2: Medium Risk
		TYPE C: Activity generates moderate to high levels of dust, requires greater 1 work shift for completion				GROUP 3: Medium/High Risk
		TYPE D: Major duration and construction activities Requiring consecutive work shifts				GROUP 4: Highest Risk
CLASS I		1. Execute work by methods to minimize raising dust from construction operations. 2. Immediately replace any ceiling tile displaced for visual inspection.		3. Minor Demolition for Remodeling		
CLASS II		1. Provides active means to prevent air-borne dust from dispersing into atmosphere 2. Water mist work surfaces to control dust while cutting. 3. Seal unused doors with duct tape. 4. Block off and seal air vents. 5. Wipe surfaces with disinfectant.		6. Contain construction waste before transport in tightly covered containers. 7. Wet mop and/or vacuum with HEPA filtered vacuum before leaving work area. 8. Place dust mat at entrance and exit of work area. 9. Remove or isolate HVAC system in areas where work is being performed.		
CLASS III		1. Obtain infection control permit before construction begins. 2. Isolate HVAC system in area where work is being done to prevent contamination of the duct system. 3. Complete all critical barriers or implement control cube method before construction begins.		6. Vacuum work with HEPA filtered vacuums. 7. Wet mop with disinfectant 8. Remove barrier materials carefully to minimize spreading of dirt and debris associated with construction. 9. Contain construction waste before transport in tightly covered containers.		
Date		4. Maintain negative air pressure within work site utilizing HEPA equipped air filtration units.		10. Cover transport receptacles or carts. Tape covering.		
Initial		5. Do not remove barriers from work area until complete project is thoroughly cleaned by Env. Services Dept.		11. Remove or isolate HVAC system in areas where work is being performed/		
Class IV		1. Obtain infection control permit before construction begins. 2. Isolate HVAC system in area where work is being done to prevent contamination of duct system. 3. Complete all critical barriers or implement control cube method before construction begins.		7. All personnel entering work site are required to wear shoe covers 8. Do not remove barriers from work area until completed project is thoroughly cleaned by the Environmental Service Dept.		
Date		4. Maintain negative air pressure within work site utilizing HEPA equipped air filtration units.		9. Vacuum work area with HEPA filtered vacuums. 10. Wet mop with disinfectant.		
Initial		5. Seal holes, pipes, conduits, and punctures appropriately. 6. Construct anteroom and require all personnel to pass through this room so they can be vacuumed using a HEPA vacuum cleaner before leaving work site or they can wear cloth or paper coveralls that are removed each time they leave the work site.		11. Remove barrier materials carefully to minimize spreading of dirt and debris associated with construction. 12. Contain construction waste before transport in tightly covered containers. 13. Cover transport receptacles or carts. Tape covering. 14. Remove or isolate HVAC system in areas where is being done.		
Additional Requirements:						

SECTION 015221B – ICRA INFECTION CONTROL FOR CONSTRUCTION AND
RENOVATION

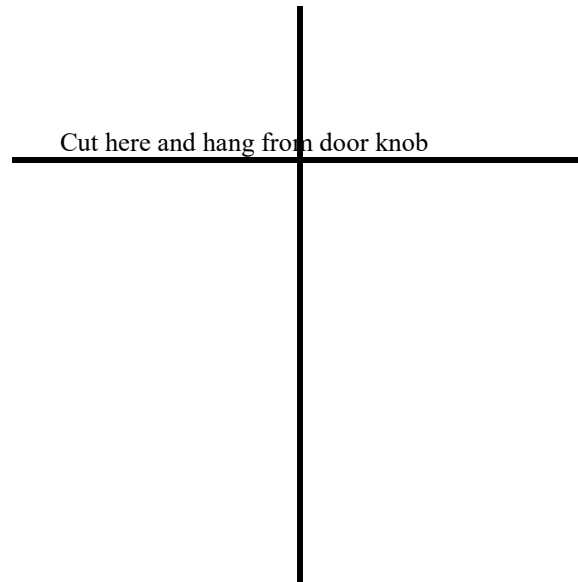

Bartlett Regional Hospital

**MAINTENANCE/CONSTRUCTION
IN PROCESS**

KEEP DOOR CLOSED

**Per Infection Control Policy
Contact the Project Manager**

at _____ for questions

END OF SECTION 015221B

SECTION 015221C – PERSONNEL IMMUNIZATION REQUIREMENTS

PART 1 – GENERAL

1.1 Personnel Immunization Requirements

A. General:

1. All CONTRACTOR personnel working on site in the main BRH building shall comply with BRH's Non-Employee Immunization Policy. Refer to forms provided in Appendix A following this section. The immunization requirements do not apply to the Juneau Medical Center building.
2. BRH (OWNER) may update and/or make changes to the current Non-Employee Immunization Policy at any time. CONTRACTOR is required to comply with any changes to the policy within a reasonable time period. No change of contract time will be permitted due to current or updated Personnel Immunization Requirements.
3. Individual CONTRACTOR employees who will be working on site more than seven days (cumulatively) will be required to meet immunization requirements or wear a mask 100% of the time on site. Each day the employee is on site will constitute one day; a partial day will be counted as one day.

B. The CONTRACTOR shall;

1. Provide all required documents to show proof of immunization records.
2. Attain approval of all submitted immunization records, waivers, and/or other submissions for personnel before said personnel begins work on the BRH campus.

1.5 RESTRICTIONS WITHIN ACTIVE CONSTRUCTION AREAS

- ##### A.
- All personnel employed on the Project site by the CONTRACTOR, Subcontractors, Suppliers, installers and other entities engaged in WORK shall strictly adhere to the security, safety, confidentiality, and hospital compliance program requirements depicted within this section.

1.6 INFECTION CONTROL MEASURES

- ##### A.
- The CONTRACTOR shall comply with the Infection Risk Control Assessment (ICRA): Infection Control for Construction and Renovation Policy and requirements set forth in Section 015221B.
- ##### B.
- The CONTRACTOR shall complete and comply with the Personnel Immunization Requirements forms in Section 015221C, Appendix A.

Appendix A: Refer to Forms provided on the following two pages:

PART 2 - PRODUCTS (Not Used)

PART 3 - EXECUTION (Not Used)

END OF SECTION 015221C

SECTION 015221C – PERSONNEL IMMUNIZATION REQUIREMENTS

APPENDIX A Non-employee HR and EH Immunization Form

Anticipated Start date: _____

Status Type:

- Volunteer (presenters/instructors/etc.)
- Job Shadow (affiliated with school/ BRH employee/ job applicant - Supervised)
- Clinical Practicum (affiliated with college/university - Supervised)
- Intern (affiliated with college/university – Independent)
- Allied Health Professional (affiliated with sponsoring organization – Independent)
- Traveler (affiliated with Medefis – Independent)
- Contractor (came through Contracts Administrator – Independent)

NOTE: All Types must show acceptable proof of immunizations prior to start date! See back for details.

If affiliated with school/college/university - Name: _____

Length of visit/ Anticipated work (be specific): # hours: _____ # weeks: _____

Badge Type: Faceplate Only Faceplate & door access Doors: _____

Computer Access: No Yes, Programs/Modules: _____

Supervised: Yes No *

Non Employee Name: _____ **Date of Birth:** _____

Contact phone #: _____

SECTION 015221C – PERSONNEL IMMUNIZATION REQUIREMENTS

Bartlett Regional Hospital

NON- EMPLOYEE IMMUNIZATION REQUIREMENTS

Please fill this immunization record out completely. Show results for each of the diseases listed. You **will not** be able to participate in Career Connections on the Bartlett Campus in any capacity unless this is fully completed. Electronic record printouts are accepted and can be attached.

Requirements	Results
Tuberculosis (TB) – Either: 1. Two step TST (TB skin test); OR 2. QuantiFERON TB Gold Test; OR 3. Documentation of TST from last 2 years -If previous positive TST or newly positive TST/ QuantiFERON TB Gold must show proof of Chest x-ray within last 2 yrs.	TB – 2-step PPD skin test: Result Date: Result: Pos Neg Result Date: Result: Pos Neg <p align="center">OR</p> QuantiFERON TB Gold Result Date: Result: Pos Neg
Measles, Mumps, Rubella (MMR) Either: 1. Documented MMR vaccine (2 shots) OR 2. Positive titer showing immunity	Dates MMR Series Complete: 1. 2. <p align="center">OR</p> <u>Immune Titer Date:</u> Measles Pos Neg Mumps Pos Neg Rubella Pos Neg
Varicella – (Chicken Pox) – Either: 1. Varicella vaccine x 2; OR 2. Positive Varicella titer	Dates Varicella Series Complete: 1. 2. <p align="center">OR</p> <u>Immune Titer Date:</u> Result: Pos Neg
Influenza – (Flu) – Either: 1. Current Seasonal Influenza vaccine; OR 2. Declination Form (continuous masking will be required) Will receive in-person masking instructions	Flu Shot Date: Declination Form Rcvd:
Tetanus, Diphtheria, Pertussis (Tdap): 1. Tdap vaccine. 1 dose of Tdap as an adult AND 2. Booster every 10 years after that date.	Tdap Vaccine Date: Tdap Booster Date:
Recommended if you will be working in close proximity with blood and body fluids- but not required.	
Hepatitis B: 1. Hepatitis B vaccine series or 2. Hepatitis B titer showing immunity	Hep B vaccination dates: 1. 2. 3. <p align="center">OR</p> Hep B Titer Date: Immunity Pos Neg

I attest that the above immunization & testing records for patient named above are accurate & will remain current for the duration of their time at Bartlett Regional Hospital. Supportive documentation is maintained in my office.

Provider Name & credentials (please print/stamp): _____

Provider Address & Phone#: _____

ADMINISTRATIVE USE ONLY: Human Resources / Med Staff / Employee Health Review: (circle one) Print Name: _____ Date: _____

SECTION 016000 - PRODUCT REQUIREMENTS

PART 1 - GENERAL

1.1 RELATED DOCUMENTS

- A. Drawings and general provisions of the Contract, including General and Supplementary Conditions and other Division 01 Specification Sections, apply to this Section.

1.2 SUMMARY

- A. Section includes administrative and procedural requirements for selection of products for use in Project; product delivery, storage, and handling; manufacturers' standard warranties on products; special warranties; and comparable products.
- B. Related Requirements:
 - 1. Section 012500 "Substitution Procedures" for requests for substitutions.

1.3 DEFINITIONS

- A. Products: Items obtained for incorporating into the Work, whether purchased for Project or taken from previously purchased stock. The term "product" includes the terms "material," "equipment," "system," and terms of similar intent.
 - 1. Named Products: Items identified by manufacturer's product name, including make or model number or other designation shown or listed in manufacturer's published product literature, that is current as of date of the Contract Documents.
 - 2. New Products: Items that have not previously been incorporated into another project or facility. Products salvaged or recycled from other projects are not considered new products.
 - 3. Comparable Product: Product that is demonstrated and approved through submittal process to have the indicated qualities related to type, function, dimension, in-service performance, physical properties, appearance, and other characteristics that equal or exceed those of specified product.
- B. Basis-of-Design Product Specification: A specification in which a specific manufacturer's product is named and accompanied by the words "basis-of-design product," including make or model number or other designation, to establish the significant qualities related to type, function, dimension, in-service performance, physical properties, appearance, and other characteristics for purposes of evaluating comparable products of additional manufacturers named in the specification.

1.4 ACTION SUBMITTALS

- A. Comparable Product Requests: Submit request for consideration of each comparable product. Identify product or fabrication or installation method to be replaced. Include Specification Section number and title and Drawing numbers and titles.

SECTION 016000 - PRODUCT REQUIREMENTS

1. Include data to indicate compliance with the requirements specified in "Comparable Products" Article.
 2. Architect's Action: If necessary, Architect will request additional information or documentation for evaluation within one week of receipt of a comparable product request. Architect will notify Contractor through Owner's Representative of approval or rejection of proposed comparable product request within 15 days of receipt of request, or seven days of receipt of additional information or documentation, whichever is later.
 - a. Form of Approval: As specified in Section 013300 "Submittal Procedures."
 - b. Use product specified if Architect does not issue a decision on use of a comparable product request within time allocated.
- B. Basis-of-Design Product Specification Submittal: Comply with requirements in Section 013300 "Submittal Procedures." Show compliance with requirements.

1.5 PRODUCT DELIVERY, STORAGE, AND HANDLING

- A. Deliver, store, and handle products using means and methods that will prevent damage, deterioration, and loss, including theft and vandalism. Comply with manufacturer's written instructions.
- B. Delivery and Handling:
 1. Schedule delivery to minimize long-term storage at Project site and to prevent overcrowding of construction spaces.
 2. Coordinate delivery with installation time to ensure minimum holding time for items that are flammable, hazardous, easily damaged, or sensitive to deterioration, theft, and other losses.
 3. Deliver products to Project site in an undamaged condition in manufacturer's original sealed container or other packaging system, complete with labels and instructions for handling, storing, unpacking, protecting, and installing.
 4. Inspect products on delivery to determine compliance with the Contract Documents and to determine that products are undamaged and properly protected.
- C. Storage:
 1. Store products to allow for inspection and measurement of quantity or counting of units.
 2. Store materials in a manner that will not endanger Project structure.
 3. Store products that are subject to damage by the elements, under cover in a weather tight enclosure above ground, with ventilation adequate to prevent condensation.
 4. Protect foam plastic from exposure to sunlight, except to extent necessary for period of installation and concealment.
 5. Comply with product manufacturer's written instructions for temperature, humidity, ventilation, and weather-protection requirements for storage.
 6. Protect stored products from damage and liquids from freezing.

SECTION 016000 - PRODUCT REQUIREMENTS

1.6 PRODUCT WARRANTIES

- A. Warranties specified in other Sections shall be in addition to, and run concurrent with, other warranties required by the Contract Documents. Manufacturer's disclaimers and limitations on product warranties do not relieve Contractor of obligations under requirements of the Contract Documents.
 - 1. Manufacturer's Warranty: Written warranty furnished by individual manufacturer for a particular product and specifically endorsed by manufacturer to Owner.
 - 2. Special Warranty: Written warranty required by the Contract Documents to provide specific rights for Owner.
- B. Special Warranties: Prepare a written document that contains appropriate terms and identification, ready for execution.
 - 1. Manufacturer's Standard Form: Modified to include Project-specific information and properly executed.
 - 2. Specified Form: When specified forms are included with the Specifications, prepare a written document using indicated form properly executed.
 - 3. See other Sections for specific content requirements and particular requirements for submitting special warranties.
- C. Submittal Time: Comply with requirements in Section 017700 "Closeout Procedures."

PART 2 - PRODUCTS

2.1 PRODUCT SELECTION PROCEDURES

- A. General Product Requirements: Provide products that comply with the Contract Documents, are undamaged and, unless otherwise indicated, are new at time of installation.
 - 1. Provide products complete with accessories, trim, finish, fasteners, and other items needed for a complete installation and indicated use and effect.
 - 2. Standard Products: If available, and unless custom products or nonstandard options are specified, provide standard products of types that have been produced and used successfully in similar situations on other projects.
 - 3. Owner reserves the right to limit selection to products with warranties not in conflict with requirements of the Contract Documents.
 - 4. Where products are accompanied by the term "as selected," Architect will make selection.
 - 5. Descriptive, performance, and reference standard requirements in the Specifications establish salient characteristics of products.
 - 6. Or Equal: For products specified by name and accompanied by the term "or equal," or "or approved equal," or "or approved," comply with requirements in "Comparable Products" Article to obtain approval for use of an unnamed product.
- B. Product Selection Procedures:

SECTION 016000 - PRODUCT REQUIREMENTS

1. Product: Where Specifications name a single manufacturer and product, provide the named product that complies with requirements. Comparable products or substitutions for Contractor's convenience will not be considered.
 2. Manufacturer/Source: Where Specifications name a single manufacturer or source, provide a product by the named manufacturer or source that complies with requirements. Comparable products or substitutions for Contractor's convenience will not be considered.
 3. Products:
 - a. Restricted List: Where Specifications include a list of names of both manufacturers and products, provide one of the products listed that complies with requirements. Comparable products or substitutions for Contractor's convenience will not be considered unless otherwise indicated.
 - b. Nonrestricted List: Where Specifications include a list of names of both available manufacturers and products, provide one of the products listed, or an unnamed product, that complies with requirements. Comply with requirements in "Comparable Products" Article for consideration of an unnamed product.
 4. Manufacturers:
 - a. Restricted List: Where Specifications include a list of manufacturers' names, provide a product by one of the manufacturers listed that complies with requirements. Comparable products or substitutions for Contractor's convenience will not be considered unless otherwise indicated.
 - b. Nonrestricted List: Where Specifications include a list of available manufacturers, provide a product by one of the manufacturers listed, or a product by an unnamed manufacturer, that complies with requirements. Comply with requirements in "Comparable Products" Article for consideration of an unnamed manufacturer's product.
 5. Basis-of-Design Product: Where Specifications name a product, or refer to a product indicated on Drawings, and include a list of manufacturers, provide the specified or indicated product or a comparable product by one of the other named manufacturers. Drawings and Specifications indicate sizes, profiles, dimensions, and other characteristics that are based on the product named. Comply with requirements in "Comparable Products" Article for consideration of an unnamed product by one of the other named manufacturers.
- C. Visual Matching Specification: Where Specifications require "match Architect's sample", provide a product that complies with requirements and matches Architect's sample. Architect's decision will be final on whether a proposed product matches.
1. If no product available within specified category matches and complies with other specified requirements, comply with requirements in Section 012500 "Substitution Procedures" for proposal of product.
- D. Visual Selection Specification: Where Specifications include the phrase "as selected by Architect from manufacturer's full range" or similar phrase, select a product that complies with requirements. Architect will select color, gloss, pattern, density, or texture from manufacturer's product line that includes both standard and premium items.

SECTION 016000 - PRODUCT REQUIREMENTS

2.2 COMPARABLE PRODUCTS

- A. Conditions for Consideration: Architect will consider Contractor's request for comparable product when the following conditions are satisfied. If the following conditions are not satisfied, Architect may return requests without action, except to record noncompliance with these requirements:
1. Evidence that the proposed product does not require revisions to the Contract Documents, that it is consistent with the Contract Documents and will produce the indicated results, and that it is compatible with other portions of the Work.
 2. Detailed comparison of significant qualities of proposed product with those named in the Specifications. Significant qualities include attributes such as performance, weight, size, durability, visual effect, and specific features and requirements indicated.
 3. Evidence that proposed product provides specified warranty.
 4. List of similar installations for completed projects with project names and addresses and names and addresses of architects and owners, if requested.
 5. Samples, if requested.

PART 3 - EXECUTION (Not Used)

END OF SECTION

SECTION 017300 - EXECUTION

PART 1 - GENERAL

1.1 RELATED DOCUMENTS

- A. Drawings and general provisions of the Contract, including General and Supplementary Conditions and other Division 01 Specification Sections, apply to this Section.

1.2 SUMMARY

- A. Section includes general administrative and procedural requirements governing execution of the Work including, but not limited to, the following:
 - 1. Installation of the Work.
 - 2. Cutting and patching.
 - 3. Progress cleaning.
 - 4. Starting and adjusting.
 - 5. Protection of installed construction.
 - 6. Correction of the Work.
- B. Related Requirements:
 - 1. Section 011000 "Summary" for limits on use of Project site.

1.3 DEFINITIONS

- A. Cutting: Removal of in-place construction necessary to permit installation or performance of other work.
- B. Patching: Fitting and repair work required to restore construction to original conditions after installation of other work.

PART 2 - PRODUCTS

2.1 MATERIALS

- A. In-Place Materials: Use materials for patching identical to in-place materials. For exposed surfaces, use materials that visually match in-place adjacent surfaces to the fullest extent possible.
 - 1. If identical materials are unavailable or cannot be used, use materials that, when installed, will provide a match acceptable to Architect for the visual and functional performance of in-place materials.

SECTION 017300 - EXECUTION

PART 3 - EXECUTION

3.1 EXAMINATION

- A. Existing Conditions: The existence and location of underground and other utilities and construction indicated as existing are not guaranteed. Before beginning work, investigate and verify the existence and location of mechanical and electrical systems, and other construction affecting the Work.
 - 1. Before construction, verify the location and invert elevation at points of connection of sanitary sewer and water-service piping and other utilities.
- B. Examination and Acceptance of Conditions: Before proceeding with each component of the Work, examine substrates, areas, and conditions, with Installer or Applicator present where indicated, for compliance with requirements for installation tolerances and other conditions affecting performance. Record observations.
 - 1. Examine roughing-in for mechanical and electrical systems to verify actual locations of connections before equipment and fixture installation.
 - 2. Examine walls, floors, and roofs for suitable conditions where products and systems are to be installed.
 - 3. Verify compatibility with and suitability of substrates, including compatibility with existing finishes or primers.
- C. Proceed with installation only after unsatisfactory conditions have been corrected. Proceeding with the Work indicates acceptance of surfaces and conditions.

3.2 PREPARATION

- A. Field Measurements: Take field measurements as required to fit the Work properly. Recheck measurements before installing each product. Where portions of the Work are indicated to fit to other construction, verify dimensions of other construction by field measurements before fabrication. Coordinate fabrication schedule with construction progress to avoid delaying the Work. Where construction schedule does not allow field measurement prior to fabrication layout work according to coordination drawings allowing tolerances needed to assure proper fit of Work.
- B. Space Requirements: Verify space requirements and dimensions of items shown diagrammatically on Drawings.
- C. Review of Contract Documents and Field Conditions: Immediately on discovery of the need for clarification of the Contract Documents caused by differing field conditions outside the control of Contractor, submit a request for information to Architect according to requirements in Section 013100 "Project Management and Coordination."

SECTION 017300 - EXECUTION

3.3 INSTALLATION

- A. General: Locate the Work and components of the Work accurately, in correct alignment and elevation, as indicated.
 - 1. Make vertical work plumb and make horizontal work level.
 - 2. Where space is limited, install components to maximize space available for maintenance and ease of removal for replacement.
 - 3. Conceal pipes, ducts, conduit and wiring in finished areas unless otherwise indicated.
- B. Comply with manufacturer's written instructions and recommendations for installing products in applications indicated.
- C. Install products at the time and under conditions that will ensure the best possible results. Maintain conditions required for product performance until Substantial Completion.
- D. Conduct construction operations so no part of the Work is subjected to damaging operations or loading in excess of that expected during normal conditions of occupancy.
- E. Sequence the Work and allow adequate clearances to accommodate movement of construction items on site and placement in permanent locations.
- F. Tools and Equipment: Do not use tools or equipment that produce harmful noise levels.
- G. Templates: Obtain and distribute to the parties involved templates for work specified to be factory prepared and field installed. Check Shop Drawings of other work to confirm that adequate provisions are made for locating and installing products to comply with indicated requirements.
- H. Attachment: Provide blocking and attachment plates and anchors and fasteners of adequate size and number to securely anchor each component in place, accurately located and aligned with other portions of the Work. Where size and type of attachments are not indicated, verify size and type required for load conditions.
 - 1. Mounting Heights: Where mounting heights are not indicated, mount components at heights directed by Architect.
 - 2. Allow for building movement, including thermal expansion and contraction.
 - 3. Coordinate installation of anchorages. Furnish setting drawings, templates, and directions for installing anchorages, including sleeves, concrete inserts, anchor bolts, and items with integral anchors, that are to be embedded in concrete or masonry. Deliver such items to Project site in time for installation.
- I. Joints: Make joints of uniform width. Where joint locations in exposed work are not indicated, arrange joints for the best visual effect. Fit exposed connections together to form hairline joints.
- J. Hazardous Materials: Use products, cleaners, and installation materials that are not considered hazardous.

SECTION 017300 - EXECUTION

3.4 CUTTING AND PATCHING

- A. Cutting and Patching, General: Employ skilled workers to perform cutting and patching. Proceed with cutting and patching at the earliest feasible time, and complete without delay.
 - 1. Cut in-place construction to provide for installation of other components or performance of other construction, and subsequently patch as required to restore surfaces to their original condition.
- B. Temporary Support: Provide temporary support of work to be cut.
- C. Protection: Protect in-place construction during cutting and patching to prevent damage. Provide protection from adverse weather conditions for portions of Project that might be exposed during cutting and patching operations.
- D. Adjacent Occupied Areas: Where interference with use of adjoining areas or interruption of free passage to adjoining areas is unavoidable, coordinate cutting and patching according to requirements in Section 011000 "Summary."
- E. Existing Utility Services and Mechanical/Electrical Systems: Where existing services/systems are required to be removed, relocated, or abandoned, bypass such services/systems before cutting to minimize interruption to occupied areas.
- F. Cutting: Cut in-place construction by sawing, drilling, breaking, chipping, grinding, and similar operations, including excavation, using methods least likely to damage elements retained or adjoining construction. If possible, review proposed procedures with original Installer; comply with original Installer's written recommendations.
 - 1. In general, use hand or small power tools designed for sawing and grinding, not hammering and chopping. Cut holes and slots neatly to minimum size required, and with minimum disturbance of adjacent surfaces. Temporarily cover openings when not in use.
 - 2. Finished Surfaces: Cut or drill from the exposed or finished side into concealed surfaces.
 - 3. Concrete: Cut using a cutting machine, such as an abrasive saw or a diamond-core drill.
 - 4. Excavating and Backfilling: Comply with requirements in applicable Sections where required by cutting and patching operations.
 - 5. Mechanical and Electrical Services: Cut off pipe or conduit in walls or partitions to be removed. Cap, valve, or plug and seal remaining portion of pipe or conduit to prevent entrance of moisture or other foreign matter after cutting.
 - 6. Proceed with patching after construction operations requiring cutting are complete.
- G. Patching: Patch construction by filling, repairing, refinishing, closing up, and similar operations following performance of other work. Patch with durable seams that are as invisible as practicable. Provide materials and comply with installation requirements specified in other Sections, where applicable.
 - 1. Inspection: Where feasible, test and inspect patched areas after completion to demonstrate physical integrity of installation.
 - 2. Exposed Finishes: Restore exposed finishes of patched areas and extend finish restoration into retained adjoining construction in a manner that will minimize evidence of patching and refinishing.

SECTION 017300 - EXECUTION

- a. Clean piping, conduit, and similar features before applying paint or other finishing materials.
 - b. Restore damaged pipe covering to its original condition.
3. Floors and Walls: Where walls or partitions that are removed extend one finished area into another, patch and repair floor and wall surfaces in the new space. Provide an even surface of uniform finish, color, texture, and appearance. Remove in-place floor and wall coverings and replace with new materials, if necessary, to achieve uniform color and appearance.
 - a. Where patching occurs in a painted surface, prepare substrate and apply primer and intermediate paint coats appropriate for substrate over the patch, and apply final paint coat over entire unbroken surface containing the patch. Provide additional coats until patch blends with adjacent surfaces.
 4. Ceilings: Patch, repair, or rehang in-place ceilings as necessary to provide an even-plane surface of uniform appearance.
 5. Exterior Building Enclosure: Patch components in a manner that restores enclosure to a weather tight condition and ensures thermal and moisture integrity of building enclosure.
- H. Cleaning: Clean areas and spaces where cutting and patching are performed. Remove paint, mortar, oils, putty, and similar materials from adjacent finished surfaces.

3.5 PROGRESS CLEANING

- A. General: Clean Project site and work areas daily, including common areas. Enforce requirements strictly. Dispose of materials lawfully.
1. Comply with requirements in NFPA 241 for removal of combustible waste materials and debris.
 2. Do not hold waste materials more than seven days during normal weather or three days if the temperature is expected to rise above 80 deg F (27 deg C).
 3. Containerize hazardous and unsanitary waste materials separately from other waste. Mark containers appropriately and dispose of legally, according to regulations.
 - a. Use containers intended for holding waste materials of type to be stored.
 4. Coordinate progress cleaning for joint-use areas where Contractor and other contractors are working concurrently.
- B. Site: Maintain Project site free of waste materials and debris.
- C. Work Areas: Clean areas where work is in progress to the level of cleanliness necessary for proper execution of the Work.
1. Remove liquid spills promptly.
 2. Where dust would impair proper execution of the Work, broom-clean or vacuum the entire work area, as appropriate.

SECTION 017300 - EXECUTION

- D. **Installed Work:** Keep installed work clean. Clean installed surfaces according to written instructions of manufacturer or fabricator of product installed, using only cleaning materials specifically recommended. If specific cleaning materials are not recommended, use cleaning materials that are not hazardous to health or property and that will not damage exposed surfaces.
- E. **Concealed Spaces:** Remove debris from concealed spaces before enclosing the space.
- F. **Exposed Surfaces in Finished Areas:** Clean exposed surfaces and protect as necessary to ensure freedom from damage and deterioration at time of Substantial Completion.
- G. **Waste Disposal:** Do not bury or burn waste materials on-site. Do not wash waste materials down sewers or into waterways. Comply with waste disposal requirements in Section 015000 "Temporary Facilities and Controls."
- H. **During handling and installation,** clean and protect construction in progress and adjoining materials already in place. Apply protective covering where required to ensure protection from damage or deterioration at Substantial Completion.
- I. **Clean and provide maintenance on completed construction** as frequently as necessary through the remainder of the construction period. Adjust and lubricate operable components to ensure operability without damaging effects.
- J. **Limiting Exposures:** Supervise construction operations to assure that no part of the construction, completed or in progress, is subject to harmful, dangerous, damaging, or otherwise deleterious exposure during the construction period.

3.6 PROTECTION OF INSTALLED CONSTRUCTION

- A. Provide final protection and maintain conditions that ensure installed Work is without damage or deterioration at time of Substantial Completion.
- B. Provide protection and maintain conditions that ensure existing finishes are without damage or deterioration at time of Substantial Completion.
- C. Comply with manufacturer's written instructions for temperature and relative humidity.

END OF SECTION

SECTION 017700 - CLOSEOUT PROCEDURES

PART 1 - GENERAL

1.1 RELATED DOCUMENTS

- A. Drawings and general provisions of the Contract, including General and Supplementary Conditions and other Division 01 Specification Sections, apply to this Section.

1.2 SUMMARY

- A. Section includes administrative and procedural requirements for contract closeout, including, but not limited to, the following:
 - 1. Substantial Completion procedures.
 - 2. Final completion procedures.
 - 3. Warranties.
 - 4. Final cleaning.
 - 5. Repair of the Work.
- B. Related Requirements:
 - 1. Section 017300 "Execution" for progress cleaning of Project site.
 - 2. Section 017823 "Operation and Maintenance Data" for operation and maintenance manual requirements.

1.3 ACTION SUBMITTALS

- A. Product Data: For cleaning agents.
- B. Contractor's List of Incomplete Items: Initial submittal at Substantial Completion.
- C. Certified List of Incomplete Items: Final submittal at Final Completion.

1.4 FINAL ACCEPTANCE

- A. Before requesting inspection for certification of final acceptance and final payment, complete and submit the following:
 - 1. Submit final payment request.
 - 2. Submit a final Change Order request.
 - 3. Submit a copy of the final inspection list stating that each item has been completed or otherwise resolved for acceptance.
 - 4. Submit final meter readings for utilities, a record of stored fuel, and similar data as of Substantial Completion.
 - 5. Submit consent of surety to final payment.
 - 6. Submit evidence of continuing insurance coverage complying with insurance requirements.

SECTION 017700 - CLOSEOUT PROCEDURES

7. Written guarantees where required.
8. Maintenance stock items; spare parts; special tools, where required.
9. Certificates of final inspection and acceptance by local governing agencies having jurisdiction.
10. Completed CBJ Certificate of Compliance and Release form attached with this section.
11. Final Subcontractor list complete with final subcontract amounts and include all equipment rentals (with operators).
12. Alaska Department of Revenue Corporate Income Tax Clearance letter for the CONTRACTOR.
13. Before final payment can be made, the CONTRACTOR shall supply a copy of the "Notice of Completion of Public Works" form approved by Wage and Hour Administration of the Labor Standards and Safety Division of the Alaska Department of Labor and Workforce Development.
14. Alaska Department of Labor Employment Security Tax Clearance letter for the CONTRACTOR and all Subcontractors, a copy of which is located at the end of Section 00800 – Supplementary General Conditions.
15. Submit original items 11, 12, 13 and 14 to Contracts Administrator, CBJ Engineering.

1.5 MAINTENANCE MATERIAL SUBMITTALS

- A. Schedule of Maintenance Material Items: For maintenance material submittal items specified in other Sections.

1.6 SUBSTANTIAL COMPLETION PROCEDURES

- A. Contractor's List of Incomplete Items: Prepare and submit a list of items to be completed and corrected (Contractor's punch list), indicating all Work that is incomplete.
- B. Submittals Prior to Substantial Completion: Complete the following a minimum of 5 days prior to requesting inspection for determining date of Substantial Completion. List items below that are incomplete at time of request.
 1. Certificates of Release: Obtain and submit releases from authorities having jurisdiction permitting Owner unrestricted use of the Work and access to services and utilities. Include occupancy permits, operating certificates, and similar releases.
 2. Submit closeout submittals specified in other Division 01 Sections, including project record documents, operation and maintenance manuals, final completion construction photographic documentation, damage or settlement surveys, property surveys, and similar final record information for each phase.
 3. Submit closeout submittals specified in individual Sections, including specific warranties, workmanship bonds, maintenance service agreements, final certifications, and similar documents.
 4. Submit maintenance material submittals specified in individual Sections, including tools, spare parts, extra materials, and similar items, and deliver to location designated by Owner's Representative. Label with manufacturer's name and model number where applicable.
 5. Submit test/adjust/balance records.
 6. Submit changeover information related to Owner's occupancy, use, operation, and maintenance.

SECTION 017700 - CLOSEOUT PROCEDURES

- C. Procedures Prior to Substantial Completion: Complete the following a minimum of 5 days prior to requesting inspection for determining date of Substantial Completion. List items below that are incomplete at time of request.
1. Advise Owner of pending insurance changeover requirements.
 2. Make final changeover of permanent locks and deliver keys to Owner. Advise Owner's personnel of changeover in security provisions.
 3. Complete startup and testing of systems and equipment.
 4. Perform preventive maintenance on equipment used prior to Substantial Completion.
 5. Terminate and remove temporary facilities from Project site, along with mockups, construction tools, and similar elements.
 6. Complete final cleaning requirements, including touchup painting.
 7. Touch up and otherwise repair and restore marred exposed finishes to eliminate visual defects.
- D. Inspection: Submit a written request for inspection to determine Substantial Completion a minimum of 5 days prior to date the work will be completed and ready for final inspection and tests. On receipt of request, Architect and Owner's Representative will either proceed with inspection or notify Contractor of unfulfilled requirements. Architect will prepare the Certificate of Substantial Completion after inspection or will notify Contractor of items, either on Contractor's list or additional items identified by Architect, that must be completed or corrected before certificate will be issued.
1. Reinspection: Request reinspection when the Work identified in previous inspections as incomplete is completed or corrected.
 2. Results of completed inspection will form the basis of requirements for final completion.

1.7 FINAL COMPLETION PROCEDURES

- A. Submittals Prior to Final Completion: Before requesting final inspection for determining final completion, complete the following:
1. Submit a final Application for Payment according to Section 012900 "Payment Procedures."
 2. Certified List of Incomplete Items: Submit certified copy of Architect's Substantial Completion inspection list of items to be completed or corrected (punch list), endorsed and dated by Architect. Certified copy of the list shall state that each item has been completed or otherwise resolved for acceptance.
 3. Certificate of Insurance: Submit evidence of final, continuing insurance coverage complying with insurance requirements.
- B. Inspection: Submit a written request for final inspection to determine acceptance a minimum of 10 days prior to date the work will be completed and ready for final inspection and tests. On receipt of request, Architect and Owner's Representative will either proceed with inspection or notify Contractor of unfulfilled requirements. Architect will prepare a final Certificate for Payment after inspection or will notify Contractor of construction that must be completed or corrected before certificate will be issued.
1. Reinspection: Request reinspection when the Work identified in previous inspections as incomplete is completed or corrected.

SECTION 017700 - CLOSEOUT PROCEDURES

1.8 LIST OF INCOMPLETE ITEMS (PUNCH LIST)

- A. Organization of List: Include name and identification of each space and area affected by construction operations for incomplete items and items needing correction including, if necessary, areas disturbed by Contractor that are outside the limits of construction.
1. Organize list of spaces in sequential order, starting with exterior areas first and proceeding from lowest floor to highest floor.
 2. Organize items applying to each space by major element, including categories for ceiling, individual walls, floors, equipment, and building systems.
 3. Include the following information at the top of each page:
 - a. Project name.
 - b. Date.
 - c. Name of Architect.
 - d. Name of Contractor.
 - e. Page number.
 4. Submit list of incomplete items in the following format:
 - a. PDF electronic file. Architect through Owner's Representative will return annotated file.

1.9 SUBMITTAL OF PROJECT WARRANTIES

- A. Time of Submittal: Submit written warranties on request of Architect for designated portions of the Work where commencement of warranties other than date of Substantial Completion is indicated, or when delay in submittal of warranties might limit Owner's rights under warranty.
- B. Partial Occupancy: Submit properly executed warranties within 15 days of completion of designated portions of the Work that are completed and occupied or used by Owner during construction period by separate agreement with Contractor.
- C. Organize warranty documents into an orderly sequence based on the table of contents of Project Manual.
1. Bind warranties and bonds in heavy-duty, three-ring, vinyl-covered, loose-leaf binders, thickness as necessary to accommodate contents, and sized to receive 8-1/2-by-11-inch (215-by-280-mm) paper.
 2. Provide heavy paper dividers with plastic-covered tabs for each separate warranty. Mark tab to identify the product or installation. Provide a typed description of the product or installation, including the name of the product and the name, address, and telephone number of Installer.
 3. Identify each binder on the front and spine with the typed or printed title "WARRANTIES," Project name, and name of Contractor.
 4. Provide electronic PDF copy of all warranty documents.
- D. Provide additional copies of each warranty to include in operation and maintenance manuals.

SECTION 017700 - CLOSEOUT PROCEDURES

PART 2 - PRODUCTS

2.1 MATERIALS

- A. Cleaning Agents: Use cleaning materials and agents recommended by manufacturer or fabricator of the surface to be cleaned. Do not use cleaning agents that are potentially hazardous to health or property or that might damage finished surfaces.
 - 1. Use cleaning products that comply with Green Seal's GS-37, or if GS-37 is not applicable, use products that comply with the California Code of Regulations maximum allowable VOC levels.

PART 3 - EXECUTION

3.1 FINAL CLEANING

- A. General: Perform final cleaning. Conduct cleaning and waste-removal operations to comply with local laws and ordinances and Federal and local environmental and antipollution regulations.
- B. Cleaning: Employ experienced workers or professional cleaners for final cleaning. Clean each surface or unit to condition expected in an average commercial building cleaning and maintenance program. Comply with manufacturer's written instructions.
 - 1. Complete the following cleaning operations before requesting inspection for certification of Substantial Completion for entire Project or for a designated portion of Project:
 - a. Clean Project site, yard, and grounds, in areas disturbed by construction activities, including landscape development areas, of rubbish, waste material, litter, and other foreign substances.
 - b. Sweep paved areas broom clean. Remove petrochemical spills, stains, and other foreign deposits.
 - c. Rake grounds that are neither planted nor paved to a smooth, even-textured surface.
 - d. Remove tools, construction equipment, machinery, and surplus material from Project site.
 - e. Clean exposed exterior and interior hard-surfaced finishes to a dirt-free condition, free of stains, films, and similar foreign substances. Avoid disturbing natural weathering of exterior surfaces. Restore reflective surfaces to their original condition.
 - f. Remove debris and surface dust from limited access spaces, including roofs, plenums, shafts, trenches, equipment vaults, manholes, attics, and similar spaces.
 - g. Sweep concrete floors broom clean in unoccupied spaces.
 - h. Vacuum carpet and similar soft surfaces, removing debris and excess nap; clean according to manufacturer's recommendations if visible soil or stains remain.
 - i. Clean transparent materials, including mirrors and glass in doors and windows. Remove glazing compounds and other noticeable, vision-obscuring materials. Polish mirrors and glass, taking care not to scratch surfaces.

SECTION 017700 - CLOSEOUT PROCEDURES

- j. Remove labels that are not permanent.
 - k. Wipe surfaces of mechanical and electrical equipment, elevator equipment, and similar equipment. Remove excess lubrication, paint and mortar droppings, and other foreign substances.
 - l. Clean plumbing fixtures to a sanitary condition, free of stains, including stains resulting from water exposure.
 - m. Replace disposable air filters and clean permanent air filters. Clean exposed surfaces of diffusers, registers, and grills.
 - n. Clean ducts, blowers, and coils if units were operated without filters during construction or that display contamination with particulate matter on inspection.
 - 1) Clean HVAC system in compliance with NADCA Standard 1992-01. Provide written report on completion of cleaning.
 - o. Clean light fixtures, lamps, globes, and reflectors to function with full efficiency.
 - p. Leave Project clean and ready for occupancy.
- C. Construction Waste Disposal: Comply with waste disposal requirements in Section 015000 "Temporary Facilities and Controls."

3.2 REPAIR OF THE WORK

- A. Complete repair and restoration operations before requesting inspection for determination of Substantial Completion.
- B. Repair or remove and replace defective construction. Repairing includes replacing defective parts, refinishing damaged surfaces, touching up with matching materials, and properly adjusting operating equipment. Where damaged or worn items cannot be repaired or restored, provide replacements. Remove and replace operating components that cannot be repaired. Restore damaged construction and permanent facilities used during construction to specified condition.
 - 1. Remove and replace chipped, scratched, and broken glass, reflective surfaces, and other damaged transparent materials.
 - 2. Touch up and otherwise repair and restore marred or exposed finishes and surfaces. Replace finishes and surfaces that already show evidence of repair or restoration.
 - a. Do not paint over "UL" and other required labels and identification, including mechanical and electrical nameplates. Remove paint applied to required labels and identification.
 - 3. Replace parts subject to operating conditions during construction that may impede operation or reduce longevity.
 - 4. Replace burned-out bulbs, bulbs noticeably dimmed by hours of use, and defective and noisy starters in fluorescent and mercury vapor fixtures to comply with requirements for new fixtures.

SECTION 017700 - CLOSEOUT PROCEDURES

COMPLIANCE CERTIFICATE AND RELEASE FORM

PROJECT: _____
CONTRACT NO: BE _____

The **CONTRACTOR** must complete and submit this form to the Contract Administrator with respect to the entire contract and submit completed Subcontractor Compliance forms for each Subcontractor used on the Contract and listed on the Subcontractor report.

Completed forms shall be submitted upon completion of the Project. All requirements and submittals must be met before final payment will be made to the **CONTRACTOR**.

I certify that the following and any referenced attachments are true:

- All WORK has been performed, materials supplied, and requirements met in accordance with the applicable Drawings, Specifications, and Contract Documents.
- All payments to Subcontractors and Suppliers have been made in accordance with Alaska Statute 36.90.210. If not, please provide written explanation, for each case, why and the specific mutual payment agreement reached with the Supplier or Subcontractor.

- CHECK ONE:

- All Suppliers and Subcontractors have been paid in full with no claims for labor, materials or other services outstanding.
- The following Suppliers and Subcontractors are due final payment which will be made upon the release of the final payment by the CBJ. List the Suppliers and Subcontractors and the amount they are due below (attach separate sheet if necessary) :

	Supplier or Subcontractor	Amount Owed
1.		\$
2.		\$
3.		\$
4.		\$
5.		\$
6.		\$
7.		\$

SECTION 017700 - CLOSEOUT PROCEDURES

- All employees have been paid not less than the current prevailing wage rates set by the State of Alaska (or U.S. Department of Labor, as applicable).
- All equal employment opportunity, certified payroll and other reports have been filed in accordance with the prime contract.
- The attached list of Subcontractors is complete (required from CONTRACTOR). The City Engineer was advised and approved of all Subcontractors before WORK was performed and has approved any substitutions of Subcontractors.
- All DBE firms listed as a precondition of the prime contract award must have performed a commercially useful function in order for the WORK to count to a DBE goal. All DBE firms performed the WORK stated and have received at least the amount claimed for credit in the Contract Documents.
- All DBE Subcontractors must attach a signed statement of the payment amount received, the nature of WORK performed, whether any balance is outstanding, and indicate that no rebates are involved.
- If the amount paid is less than the amount originally claimed for DBE credit, the CONTRACTOR has attached approval from the City Engineer for underutilization.

I understand it is unlawful to misrepresent information in order to receive a payment which would otherwise be withheld if these conditions were not met. I am an authorized agent of this firm and sign this freely and voluntarily. The foregoing statements are true and apply to the following project contractor.

Firm Name Capacity: CONTRACTOR

Signed Printed Name and Title Date

Return completed form to: Engineering Contracts Division, City and Borough of Juneau, 155 South Seward Street, Juneau, AK 99801 or by email to: contracts@juneau.org

Call (907) 586-0800 x4196 if we can be of further assistance or if you have any questions.

SECTION 017700 - CLOSEOUT PROCEDURES

SUBCONTRACTOR COMPLIANCE CERTIFICATE AND RELEASE FORM

PROJECT: _____
CONTRACT NO: BE _____

Each **SUBCONTRACTOR** must complete and submit this form to the Contract Administrator, through the General Contractor, with respect to the entire contract.

Completed forms shall be submitted upon completion of the Project. All requirements and submittals must be met before final payment will be made to the CONTRACTOR.

I certify that the following and any referenced attachments are true:

- All WORK has been performed, materials supplied, and requirements met in accordance with the applicable Drawings, Specifications, and Contract Documents.

- _____ (name of firm) has been paid by the Contractor in accordance with Alaska Statute 36.90.210. (If not, please provide written explanation on an attached sheet, for each case. Provide specific details why payment was not made and the specific mutual payment agreement reached with the Contractor if it is still unresolved.)

- CHECK ONE:
 - I / WE have been paid in full by the Contractor, with no claims for labor, materials or other services outstanding.

 - I / WE are due the following amount from the Contractor which is included in the Contractors Request for Final Payment. WE are due a total of \$ _____ for the following individual items that have yet to be paid (attach separate sheet if necessary).

	Outstanding Payment Item	Outstanding Amount Owed
1.		\$
2.		\$
3.		\$
4.		\$
5.		\$
6.		\$
7.		\$

SECTION 017700 - CLOSEOUT PROCEDURES

- All employees have been paid not less than the current prevailing wage rates set by the State of Alaska (or U.S. Department of Labor, as applicable).
- All equal employment opportunity, certified payroll and other reports have been filed in accordance with the prime contract.

I understand it is unlawful to misrepresent information in order to receive a payment which would otherwise be withheld if these conditions were not met. I am an authorized agent of this firm and sign this freely and voluntarily. The foregoing statements are true and apply to the following project contractor.

Firm Name Capacity: SUBCONTRACTOR

Sign Printed Name and Title Date

Return completed form to: Engineering Contracts Division, City and Borough of Juneau, 155 South Seward Street, Juneau, AK 99801 or by email to: contracts@juneau.org

Call (907) 586-0800 x4196 if we can be of further assistance or if you have any questions.

SECTION 017823 - OPERATION AND MAINTENANCE DATA

PART 1 - GENERAL

1.1 RELATED DOCUMENTS

- A. Drawings and general provisions of the Contract, including General and Supplementary Conditions and other Division 01 Specification Sections, apply to this Section.

1.2 SUMMARY

- A. Section includes administrative and procedural requirements for preparing operation and maintenance manuals, including the following:
 - 1. Operation and maintenance documentation directory.
 - 2. Operation manuals for systems, subsystems, and equipment.
 - 3. Product maintenance manuals.
- B. Related Requirements:
 - 1. Section 013300 "Submittal Procedures" for submitting copies of submittals for operation and maintenance manuals.

1.3 DEFINITIONS

- A. System: An organized collection of parts, equipment, or subsystems united by regular interaction.
- B. Subsystem: A portion of a system with characteristics similar to a system.

1.4 CLOSEOUT SUBMITTALS

- A. Manual Content: Operations and maintenance manual for each item specified in individual Specification Sections. Submit operations and maintenance manual content formatted and organized as required by this Section.
- B. Format: Submit operations and maintenance manuals in both of the following formats:
 - 1. Adobe Acrobat .PDF electronic file. Assemble each manual into a composite electronically indexed file. Submit on digital media acceptable to Architect. Provide review submittals in PDF format and final corrected submittal in PDF format.
 - a. Name each indexed document file in composite electronic index with applicable item name. Include a complete electronically linked operation and maintenance directory.
 - b. Enable inserted reviewer comments on draft submittals.

SECTION 017823 - OPERATION AND MAINTENANCE DATA

2. Two paper copies. Include a complete operation and maintenance directory. Enclose title pages and directories in clear plastic sleeves. Provide paper copies for final submittal only.
- C. Initial Manual Submittal: Submit draft copy of each manual at least 15 days before commencing demonstration and training. Architect and Commissioning Agent will comment on whether general scope and content of manual are acceptable.
- D. Final Manual Submittal: Submit each manual in final form prior to requesting inspection for Final Completion and at least 10 days before commencing demonstration and training. Architect and Commissioning Agent will return copy with comments.
 1. Correct or revise each manual to comply with Architect's and Commissioning Authority's comments. Submit copies of each corrected manual within 10 days of receipt of Architect's and Commissioning Agent's comments and prior to commencing demonstration and training.

PART 2 - PRODUCTS

2.1 OPERATION AND MAINTENANCE DOCUMENTATION DIRECTORY

- A. Directory: Prepare a single, comprehensive directory of emergency, operation, and maintenance data and materials, listing items and their location to facilitate ready access to desired information. Include a section in the directory for each of the following:
 1. List of documents.
 2. List of systems.
 3. List of equipment.
 4. Table of contents.
- B. List of Systems and Subsystems: List systems alphabetically. Include references to operation and maintenance manuals that contain information about each system.
- C. List of Equipment: List equipment for each system, organized alphabetically by system. For pieces of equipment not part of system, list alphabetically in separate list.
- D. Tables of Contents: Include a table of contents for each emergency, operation, and maintenance manual.
- E. Identification: In the documentation directory and in each operation and maintenance manual, identify each system, subsystem, and piece of equipment with same designation used in the Contract Documents. If no designation exists, assign a designation according to ASHRAE Guideline 4, "Preparation of Operating and Maintenance Documentation for Building Systems."

SECTION 017823 - OPERATION AND MAINTENANCE DATA

2.2 REQUIREMENTS FOR OPERATION, AND MAINTENANCE MANUALS

- A. Organization: Unless otherwise indicated, organize each manual into a separate section for each system and subsystem, and a separate section for each piece of equipment not part of a system. Each manual shall contain the following materials, in the order listed:
1. Title page.
 2. Table of contents.
 3. Manual contents.
- B. Title Page: Include the following information:
1. Subject matter included in manual.
 2. Name and address of Project.
 3. Name and address of Owner.
 4. Date of submittal.
 5. Name and contact information for Contractor.
 6. Name and contact information for Construction Manager.
 7. Name and contact information for Architect.
 8. Name and contact information for Commissioning Authority.
 9. Names and contact information for major consultants to the Architect that designed the systems contained in the manuals.
 10. Cross-reference to related systems in other operation and maintenance manuals.
- C. Table of Contents: List each product included in manual, identified by product name, indexed to the content of the volume, and cross-referenced to Specification Section number in Project Manual.
1. If operation or maintenance documentation requires more than one volume to accommodate data, include comprehensive table of contents for all volumes in each volume of the set.
- D. Manual Contents: Organize into sets of manageable size. Arrange contents alphabetically by system, subsystem, and equipment. If possible, assemble instructions for subsystems, equipment, and components of one system into a single binder.
- E. Manuals, Electronic Files: Submit manuals in the form of a multiple file composite electronic PDF file for each manual type required.
1. Electronic Files: Use electronic files prepared by manufacturer where available. Where scanning of paper documents is required, configure scanned file for minimum readable file size.
 2. File Names and Bookmarks: Enable bookmarking of individual documents based on file names. Name document files to correspond to system, subsystem, and equipment names used in manual directory and table of contents. Group documents for each system and subsystem into individual composite bookmarked files, then create composite manual, so that resulting bookmarks reflect the system, subsystem, and equipment names in a readily navigated file tree. Configure electronic manual to display bookmark panel on opening file.
- F. Manuals, Paper Copy: Submit manuals in the form of hard copy, bound and labeled volumes.

SECTION 017823 - OPERATION AND MAINTENANCE DATA

1. Binders: Heavy-duty, three-ring, vinyl-covered, loose-leaf binders, in thickness necessary to accommodate contents, sized to hold 8-1/2-by-11-inch paper; with clear plastic sleeve on spine to hold label describing contents and with pockets inside covers to hold folded oversize sheets.
 - a. If two or more binders are necessary to accommodate data of a system, organize data in each binder into groupings by subsystem and related components. Cross-reference other binders if necessary to provide essential information for proper operation or maintenance of equipment or system.
 - b. Identify each binder on front and spine, with printed title "OPERATION AND MAINTENANCE MANUAL," Project title or name, and subject matter of contents. Indicate volume number for multiple-volume sets.
2. Dividers: Heavy-paper dividers with plastic-covered tabs for each section of the manual. Mark each tab to indicate contents. Include typed list of products and major components of equipment included in the section on each divider, cross-referenced to Specification Section number and title of Project Manual.
3. Protective Plastic Sleeves: Transparent plastic sleeves designed to enclose diagnostic software storage media for computerized electronic equipment.
4. Supplementary Text: Prepared on 8-1/2-by-11-inch white bond paper.
5. Drawings: Attach reinforced, punched binder tabs on drawings and bind with text.
 - a. If oversize drawings are necessary, fold drawings to same size as text pages and use as foldouts.
 - b. If drawings are too large to be used as foldouts, fold and place drawings in labeled envelopes and bind envelopes in rear of manual. At appropriate locations in manual, insert typewritten pages indicating drawing titles, descriptions of contents, and drawing locations.

2.3 OPERATION MANUALS

- A. Content: In addition to requirements in this Section, include operation data required in individual Specification Sections and the following information:
 1. System, subsystem, and equipment descriptions. Use designations for systems and equipment indicated on Contract Documents.
 2. Performance and design criteria if Contractor has delegated design responsibility.
 3. Operating standards.
 4. Operating procedures.
 5. Operating logs.
 6. Wiring diagrams.
 7. Control diagrams.
 8. Piped system diagrams.
 9. Precautions against improper use.
 10. License requirements including inspection and renewal dates.
- B. Descriptions: Include the following:
 1. Product name and model number. Use designations for products indicated on Contract Documents.

SECTION 017823 - OPERATION AND MAINTENANCE DATA

2. Manufacturer's name.
 3. Equipment identification with serial number of each component.
 4. Equipment function.
 5. Operating characteristics.
 6. Limiting conditions.
 7. Performance curves.
 8. Engineering data and tests.
 9. Complete nomenclature and number of replacement parts.
- C. Operating Procedures: Include the following, as applicable:
1. Startup procedures.
 2. Equipment or system break-in procedures.
 3. Routine and normal operating instructions.
 4. Regulation and control procedures.
 5. Instructions on stopping.
 6. Normal shutdown instructions.
 7. Seasonal and weekend operating instructions.
 8. Required sequences for electric or electronic systems.
 9. Special operating instructions and procedures.
- D. Systems and Equipment Controls: Describe the sequence of operation, and diagram controls as installed.
- E. Piped Systems: Diagram piping as installed, and identify color-coding where required for identification.

2.4 PRODUCT MAINTENANCE MANUALS

- A. Content: Organize manual into a separate section for each product, material, and finish. Include source information, product information, maintenance procedures, repair materials and sources, and warranties and bonds, as described below.
- B. Source Information: List each product included in manual, identified by product name and arranged to match manual's table of contents. For each product, list name, address, and telephone number of Installer or supplier and maintenance service agent, and cross-reference Specification Section number and title in Project Manual and drawing or schedule designation or identifier where applicable.
- C. Product Information: Include the following, as applicable:
1. Product name and model number.
 2. Manufacturer's name.
 3. Color, pattern, and texture.
 4. Material and chemical composition.
 5. Reordering information for specially manufactured products.
- D. Maintenance Procedures: Include manufacturer's written recommendations and the following:
1. Inspection procedures.

SECTION 017823 - OPERATION AND MAINTENANCE DATA

2. Types of cleaning agents to be used and methods of cleaning.
 3. List of cleaning agents and methods of cleaning detrimental to product.
 4. Schedule for routine cleaning and maintenance.
 5. Repair instructions.
- E. Repair Materials and Sources: Include lists of materials and local sources of materials and related services.
- F. Warranties and Bonds: Include copies of warranties and bonds and lists of circumstances and conditions that would affect validity of warranties or bonds.
1. Include procedures to follow and required notifications for warranty claims.

PART 3 - EXECUTION

3.1 MANUAL PREPARATION

- A. Product Maintenance Manual: Assemble a complete set of maintenance data indicating care and maintenance of each product, material, and finish incorporated into the Work.
- B. Operation and Maintenance Manuals: Assemble a complete set of operation and maintenance data indicating operation and maintenance of each system, subsystem, and piece of equipment not part of a system.
1. Engage a factory-authorized service representative to assemble and prepare information for each system, subsystem, and piece of equipment not part of a system.
 2. Prepare a separate manual for each system and subsystem, in the form of an instructional manual for use by Owner's operating personnel.
- C. Manufacturers' Data: Where manuals contain manufacturers' standard printed data, include only sheets pertinent to product or component installed. Mark each sheet to identify each product or component incorporated into the Work. If data include more than one item in a tabular format, identify each item using appropriate references from the Contract Documents. Identify data applicable to the Work and delete references to information not applicable.
1. Prepare supplementary text if manufacturers' standard printed data are not available and where the information is necessary for proper operation and maintenance of equipment or systems.
- D. Drawings: Prepare drawings supplementing manufacturers' printed data to illustrate the relationship of component parts of equipment and systems and to illustrate control sequence and flow diagrams. Coordinate these drawings with information contained in record Drawings to ensure correct illustration of completed installation.
1. Do not use original project record documents as part of operation and maintenance manuals.
 2. Comply with requirements of newly prepared record Drawings in Section 017839 "Project Record Documents."

SECTION 017823 - OPERATION AND MAINTENANCE DATA

- E. Comply with Section 017700 "Closeout Procedures" for schedule for submitting operation and maintenance documentation.

END OF SECTION

SECTION 017839 - PROJECT RECORD DOCUMENTS

PART 1 - GENERAL

1.1 SUMMARY

- A. Section includes administrative and procedural requirements for project record documents, including the following:
 - 1. Record Drawings.
 - 2. Record Specifications.
 - 3. Record Product Data.
- B. Related Requirements:
 - 1. Section 017823 "Operation and Maintenance Data" for operation and maintenance manual requirements.

1.2 CLOSEOUT SUBMITTALS

- A. Record Drawings: Comply with the following:
 - 1. Number of Copies: Submit copies of record Drawings as follows:
 - a. Initial Submittal:
 - 1) Submit one paper-copy set(s) of marked-up record prints.
 - 2) Submit PDF electronic files of scanned marked-up record prints.
 - 3) Architect will review for completeness and accuracy.
 - b. Final Submittal:
 - 1) Submit one paper-copy set(s) of marked-up record prints.
 - 2) Submit PDF electronic files of scanned marked-up record prints.
- B. Record Specifications: Submit one paper copy of Project's Specifications, including addenda and contract modifications.
- C. Record Product Data: Submit one paper copy of each submittal.

PART 2 - PRODUCTS

2.1 RECORD DRAWINGS

- A. Record Prints: Maintain one set of marked-up paper copies of the Contract Drawings and Shop Drawings, incorporating new and revised Drawings as modifications are issued.

SECTION 017839 - PROJECT RECORD DOCUMENTS

1. Preparation: Mark record prints to show the actual installation where installation varies from that shown originally. Require individual or entity who obtained record data, whether individual or entity is Installer, subcontractor, or similar entity, to provide information for preparation of corresponding marked-up record prints.
 - a. Give particular attention to information on concealed elements that would be difficult to identify or measure and record later.
 - b. Record data as soon as possible after obtaining it.
 - c. Record and check the markup before enclosing concealed installations.
 2. Mark the Contract Drawings and Shop Drawings completely and accurately. Use personnel proficient at recording graphic information in production of marked-up record prints.
 3. Mark record sets with erasable, red-colored pencil. Use other colors to distinguish between changes for different categories of the Work at same location.
 4. Note Construction Change Directive numbers, alternate numbers, Change Order numbers, and similar identification, where applicable.
- B. Format: Identify and date each record Drawing; include the designation "PROJECT RECORD DRAWING" in a prominent location.
1. Record Prints: Organize record prints and newly prepared record Drawings into manageable sets. Bind each set with durable paper cover sheets. Include identification on cover sheets.
 2. Format: Annotated PDF electronic file with comment function enabled.
 3. Record Digital Data Files: Organize digital data information into separate electronic files that correspond to each sheet of the Contract Drawings. Name each file with the sheet identification. Include identification in each digital data file.
 4. Identification: As follows:
 - a. Project name.
 - b. Date.
 - c. Designation "PROJECT RECORD DRAWINGS."
 - d. Name of Architect.
 - e. Name of Contractor.

2.2 RECORD SPECIFICATIONS

- A. Preparation: Mark Specifications to indicate the actual product installation where installation varies from that indicated in Specifications, addenda, and contract modifications.
1. Give particular attention to information on concealed products and installations that cannot be readily identified and recorded later.
 2. Mark copy with the proprietary name and model number of products, materials, and equipment furnished, including substitutions and product options selected.
 3. Record the name of manufacturer, supplier, Installer, and other information necessary to provide a record of selections made.
 4. Note related Change Orders, record Product Data, and record Drawings where applicable.

SECTION 017839 - PROJECT RECORD DOCUMENTS

- B. Format: Submit record Specifications as annotated PDF electronic file or paper copy.

2.3 MISCELLANEOUS RECORD SUBMITTALS

- A. Assemble miscellaneous records required by other Specification Sections for miscellaneous record keeping and submittal in connection with actual performance of the Work. Bind or file miscellaneous records and identify each, ready for continued use and reference.
- B. Format: Submit miscellaneous record submittals as PDF electronic file & paper copy.

PART 3 - EXECUTION

3.1 RECORDING AND MAINTENANCE

- A. Recording: Maintain one copy of each submittal during the construction period for project record document purposes. Post changes and revisions to project record documents as they occur; do not wait until end of Project.
- B. Maintenance of Record Documents and Samples: Store record documents and Samples in the field office apart from the Contract Documents used for construction. Do not use project record documents for construction purposes. Maintain record documents in good order and in a clean, dry, legible condition, protected from deterioration and loss. Provide access to project record documents for Architect's reference during normal working hours.

END OF SECTION

SECTION 024119 – SELECTIVE DEMOLITION

PART 1 - GENERAL

1.1 RELATED DOCUMENTS

- A. Drawings and general provisions of the Contract, including General and Supplementary Conditions and Division 01 Specification Sections, apply to this Section.

1.2 SUMMARY

- A. Section Includes:
 - 1. Demolition and removal of selected portions of building or structure.
 - 2. Demolition and removal of selected site elements.
 - 3. Salvage of existing items to be reused or recycled.

1.3 DEFINITIONS

- A. Remove: Detach items from existing construction and dispose of them off-site unless indicated to be salvaged or reinstalled.
- B. Remove and Salvage: Detach items from existing construction, in a manner to prevent damage, and deliver to Owner ready for reuse.
- C. Remove and Reinstall: Detach items from existing construction, in a manner to prevent damage, prepare for reuse, and reinstall where indicated.
- D. Existing to Remain: Leave existing items that are not to be removed and that are not otherwise indicated to be salvaged or reinstalled.
- E. Dismantle: To remove by disassembling or detaching an item from a surface, using gentle methods and equipment to prevent damage to the item and surfaces; disposing of items unless indicated to be salvaged or reinstalled.

1.4 MATERIALS OWNERSHIP

- A. Unless otherwise indicated, demolition waste becomes property of Contractor.
- B. Historic items, relics, antiques, and similar objects including, but not limited to, cornerstones and their contents, commemorative plaques and tablets, and other items of interest or value to Owner that may be uncovered during demolition remain the property of Owner.
 - 1. Carefully salvage in a manner to prevent damage and promptly return to Owner.

SECTION 024119 – SELECTIVE DEMOLITION

1.5 PREDEMOLITIONS MEETINGS

- A. Predemolition Conference: Conduct conference at a time and place to be determined.
 - 1. Inspect and discuss condition of construction to be selectively demolished.
 - 2. Review structural load limitations of existing structure.
 - 3. Review and finalize selective demolition schedule and verify availability of materials, demolition personnel, equipment, and facilities needed to make progress and avoid delays.
 - 4. Review requirements of work performed by other trades that rely on substrates exposed by selective demolition operations.
 - 5. Review areas where existing construction is to remain and requires protection.

1.6 INFORMATIONAL SUBMITTALS

- A. Qualification Data: For refrigerant recovery technician.
- B. Engineering Survey: Submit engineering survey of condition of building.
- C. Proposed Protection Measures: Submit report, including Drawings, that indicates the measures proposed for protecting individuals and property, for environmental protection, for dust control and for noise control. Indicate proposed locations and construction of barriers.
- D. Schedule of Selective Demolition Activities: Indicate the following:
 - 1. Detailed sequence of selective demolition and removal work, with starting and ending dates for each activity. Ensure Owner's Project manager's and other tenants' on-site operations are uninterrupted.
 - 2. Interruption of utility services. Indicate how long utility services will be interrupted.
 - 3. Coordination for shutoff, capping, and continuation of utility services.
 - 4. Use of elevator and stairs.
 - 5. Coordination of Owner's continuing occupancy of portions of existing building and of Owner's partial occupancy of completed Work.
- E. Predemolition Photographs or Video: Show existing conditions of adjoining construction, including finish surfaces, that might be misconstrued as damage caused by demolition operations. Comply with Section 013233 "Photographic Documentation." Submit before Work begins.
- F. Statement of Refrigerant Recovery: Signed by refrigerant recovery technician responsible for recovering refrigerant, stating that all refrigerant that was present was recovered and that recovery was performed according to EPA regulations. Include name and address of technician and date refrigerant was recovered.
- G. Warranties: Documentation indicating that existing warranties are still in effect after completion of selective demolition.

SECTION 024119 – SELECTIVE DEMOLITION

1.7 CLOSEOUT SUBMITTALS

- A. Inventory: Submit a list of items that have been removed and salvaged.

1.8 QUALITY ASSURANCE

- A. Refrigerant Recovery Technician Qualifications: Certified by an EPA-approved certification program.

1.9 FIELD CONDITIONS

- A. Owner will occupy portions of building immediately adjacent to selective demolition area. Conduct selective demolition so Owner's operations will not be disrupted.
- B. Conditions existing at time of inspection for bidding purpose will be maintained by Owner as far as practical.
 - 1. Before selective demolition, Owner will remove the following items:
 - a. Furniture and equipment
- C. Notify Architect of discrepancies between existing conditions and Drawings before proceeding with selective demolition.
- D. Hazardous Materials: It is not expected that hazardous materials will be encountered in the Work.
 - 1. Hazardous materials will be removed by Owner before start of the Work.
 - 2. If suspected hazardous materials are encountered, do not disturb; immediately notify Architect and Owner. Hazardous materials will be removed by Owner under a separate contract.
- E. Storage or sale of removed items or materials on-site is not permitted.
- F. Utility Service: Maintain existing utilities indicated to remain in service and protect them against damage during selective demolition operations.
 - 1. Maintain fire-protection facilities in service during selective demolition operations.

1.10 WARRANTY

- A. Existing Warranties: Remove, replace, patch, and repair materials and surfaces cut or damaged during selective demolition, by methods and with materials and using approved contractors so as not to void existing warranties. Notify warrantor before proceeding.
- B. Notify warrantor on completion of selective demolition, and obtain documentation verifying that existing system has been inspected and warranty remains in effect. Submit documentation at Project closeout.

SECTION 024119 – SELECTIVE DEMOLITION

1.11 COORDINATION

- A. Arrange selective demolition schedule so as not to interfere with Owner's operations.

PART 2 - PRODUCTS

2.1 PERFORMANCE REQUIREMENTS

- A. Regulatory Requirements: Comply with governing EPA notification regulations before beginning selective demolition. Comply with hauling and disposal regulations of authorities having jurisdiction.
- B. Standards: Comply with ASSE A10.6 and NFPA 241.

PART 3 - EXECUTION

3.1 EXAMINATION

- A. Verify that utilities have been disconnected and capped before starting selective demolition operations.
- B. Review Project Record Documents of existing construction or other existing condition and hazardous material information provided by Owner. Owner does not guarantee that existing conditions are same as those indicated in Project Record Documents.
- C. Verify that hazardous materials have been remediated before proceeding with building demolition operations.
- D. Survey of Existing Conditions: Record existing conditions by use of measured drawings and preconstruction photographs.
 - 1. Comply with requirements specified in Section 013233 "Photographic Documentation."
 - 2. Inventory and record the condition of items to be removed and salvaged. Provide photographs or video of conditions that might be misconstrued as damage caused by salvage operations.
 - 3. Before selective demolition or removal of existing building elements that will be reproduced or duplicated in final Work, make permanent record of measurements, materials, and construction details required to make exact reproduction.

3.2 PREPARATION

- A. Refrigerant: Before starting demolition, remove refrigerant from mechanical equipment according to 40 CFR 82 and regulations of authorities having jurisdiction.

SECTION 024119 – SELECTIVE DEMOLITION

3.3 UTILITY SERVICES AND MECHANICAL/ELECTRICAL SYSTEMS

- A. Existing Services/Systems to Remain: Maintain services/systems indicated to remain and protect them against damage.
- B. Existing Services/Systems to Be Removed, Relocated, or Abandoned: Locate, identify, disconnect, and seal or cap off utility services and mechanical/electrical systems serving areas to be selectively demolished.
 - 1. Owner will arrange to shut off indicated services/systems when requested by Contractor.
 - 2. Arrange to shut off utilities with utility companies.
 - 3. If services/systems are required to be removed, relocated, or abandoned, provide temporary services/systems that bypass area of selective demolition and that maintain continuity of services/systems to other parts of building.
 - 4. Disconnect, demolish, and remove fire-suppression systems, plumbing, and HVAC systems, equipment, and components indicated on Drawings to be removed.
 - a. Piping to Be Removed: Remove portion of piping indicated to be removed and cap or plug remaining piping with same or compatible piping material.
 - b. Equipment to Be Removed: Disconnect and cap services and remove equipment.
 - c. Equipment to Be Removed and Reinstalled: Disconnect and cap services and remove, clean, and store equipment; when appropriate, reinstall, reconnect, and make equipment operational.
 - d. Equipment to Be Removed and Salvaged: Disconnect and cap services and remove equipment and deliver to Owner.
 - e. Ducts to Be Removed: Remove portion of ducts indicated to be removed and plug remaining ducts with same or compatible ductwork material.

3.4 PROTECTION

- A. Temporary Protection: Provide temporary barricades and other protection required to prevent injury to people and damage to adjacent buildings and facilities to remain.
 - 1. Provide protection to ensure safe passage of people around selective demolition area and to and from occupied portions of building.
 - 2. Provide temporary weather protection, during interval between selective demolition of existing construction on exterior surfaces and new construction, to prevent water leakage and damage to structure and interior areas.
 - 3. Protect walls, ceilings, floors, and other existing finish work that are to remain or that are exposed during selective demolition operations.
 - 4. Cover and protect furniture, furnishings, and equipment that have not been removed.
 - 5. Comply with requirements for temporary enclosures, dust control, heating, and cooling specified in Section 015000 "Temporary Facilities and Controls."
- B. Temporary Shoring: Design, provide, and maintain shoring, bracing, and structural supports as required to preserve stability and prevent movement, settlement, or collapse of construction and finishes to remain, and to prevent unexpected or uncontrolled movement or collapse of construction being demolished.
 - 1. Strengthen or add new supports when required during progress of selective demolition.

SECTION 024119 – SELECTIVE DEMOLITION

- C. Remove temporary barricades and protections where hazards no longer exist.

3.5 SELECTIVE DEMOLITION, GENERAL

- A. General: Demolish and remove existing construction only to the extent required by new construction and as indicated. Use methods required to complete the Work within limitations of governing regulations and as follows:
 - 1. Proceed with selective demolition systematically, from higher to lower level. Complete selective demolition operations above each floor or tier before disturbing supporting members on the next lower level.
 - 2. Neatly cut openings and holes plumb, square, and true to dimensions required. Use cutting methods least likely to damage construction to remain or adjoining construction. Use hand tools or small power tools designed for sawing or grinding, not hammering and chopping. Temporarily cover openings to remain.
 - 3. Cut or drill from the exposed or finished side into concealed surfaces to avoid marring existing finished surfaces.
 - 4. Do not use cutting torches until work area is cleared of flammable materials. At concealed spaces, such as duct and pipe interiors, verify condition and contents of hidden space before starting flame-cutting operations. Maintain portable fire-suppression devices during flame-cutting operations.
 - 5. Maintain fire watch during and for at least 1 hour after flame-cutting operations.
 - 6. Maintain adequate ventilation when using cutting torches.
 - 7. Remove decayed, vermin-infested, or otherwise dangerous or unsuitable materials and promptly dispose of off-site.
 - 8. Remove structural framing members and lower to ground by method suitable to avoid free fall and to prevent ground impact or dust generation.
 - 9. Locate selective demolition equipment and remove debris and materials so as not to impose excessive loads on supporting walls, floors, or framing.
 - 10. Dispose of demolished items and materials promptly.
- B. Site Access and Temporary Controls: Conduct selective demolition and debris-removal operations to ensure minimum interference with roads, streets, walks, walkways, and other adjacent occupied and used facilities.
- C. Removed and Salvaged Items:
 - 1. Clean salvaged items.
 - 2. Pack or crate items after cleaning. Identify contents of containers.
 - 3. Store items in a secure area until delivery to Owner.
 - 4. Transport items to Owner's storage area designated by Owner.
 - 5. Protect items from damage during transport and storage.
- D. Removed and Reinstalled Items:
 - 1. Clean and repair items to functional condition adequate for intended reuse.
 - 2. Pack or crate items after cleaning and repairing. Identify contents of containers.
 - 3. Protect items from damage during transport and storage.

SECTION 024119 – SELECTIVE DEMOLITION

4. Reinstall items in locations indicated. Comply with installation requirements for new materials and equipment. Provide connections, supports, and miscellaneous materials necessary to make item functional for use indicated.
- E. Existing Items to Remain: Protect construction indicated to remain against damage and soiling during selective demolition. When permitted by Architect, items may be removed to a suitable, protected storage location during selective demolition and cleaned and reinstalled in their original locations after selective demolition operations are complete.

3.6 SELECTIVE DEMOLITION PROCEDURES FOR SPECIFIC MATERIALS

- A. Resilient Floor Coverings: Remove floor coverings and adhesive according to recommendations in RFCI's "Recommended Work Practices for the Removal of Resilient Floor Coverings." Do not use methods requiring solvent-based adhesive strippers.

3.7 DISPOSAL OF DEMOLISHED MATERIALS

- A. Remove demolition waste materials from Project site
 1. Do not allow demolished materials to accumulate on-site.
 2. Remove and transport debris in a manner that will prevent spillage on adjacent surfaces and areas.
 3. Remove debris from elevated portions of building by chute, hoist, or other device that will convey debris to grade level in a controlled descent.
 4. Comply with requirements specified in Section 017419 "Construction Waste Management and Disposal."

3.8 CLEANING

- A. Clean adjacent structures and improvements of dust, dirt, and debris caused by selective demolition operations. Return adjacent areas to condition existing before selective demolition operations began.

END OF SECTION 024119

SECTION 033000 – CAST-IN-PLACE CONCRETE

PART 1 - GENERAL

1.1 RELATED DOCUMENTS

- A. Drawings and general provisions of the Contract, including General and Supplementary Conditions and Division 01 Specification Sections, apply to this Section.

1.2 SUMMARY

- A. Section includes cast-in-place concrete, including formwork, reinforcement, concrete materials, mixture design, placement procedures, and finishes.

1.3 DEFINITIONS

- A. Cementitious Materials: Portland cement alone or in combination with one or more of the following: blended hydraulic cement, fly ash, slag cement, other pozzolans, and silica fume; materials subject to compliance with requirements.
- B. W/C Ratio: The ratio by weight of water to cementitious materials.

1.4 ACTION SUBMITTALS

- A. Product Data: For each type of product.
- B. Design Mixtures: For each concrete mixture. Submit alternate design mixtures when characteristics of materials, Project conditions, weather, test results, or other circumstances warrant adjustments.
- C. Steel Reinforcement Shop Drawings: Placing Drawings that detail fabrication, bending, and placement. Include bar sizes, lengths, material, grade, bar schedules, stirrup spacing, bent bar diagrams, bar arrangement, splices and laps, mechanical connections, tie spacing, hoop spacing, and supports for concrete reinforcement.

1.5 INFORMATIONAL SUBMITTALS

- A. Material Certificates: For each of the following, signed by manufacturers:
 - 1. Cementitious materials.
 - 2. Admixtures.
 - 3. Steel reinforcement and accessories.
 - 4. Curing compounds.
 - 5. Floor and slab treatments.
 - 6. Vapor retarders.
- B. Material Test Reports: For the following, from a qualified testing agency:

SECTION 033000 – CAST-IN-PLACE CONCRETE

1. Aggregates
 - C. Field quality-control reports.
 - D. Minutes of preinstallation conference.
- 1.6 QUALITY ASSURANCE
- A. Testing Agency Qualifications: An independent agency, qualified according to ASTM C 1077 and ASTM E 329 for testing indicated.
 - B. Welding Qualifications: Qualify procedures and personnel according to AWS D1.4/D 1.4M.
- 1.7 DELIVERY, STORAGE, AND HANDLING
- A. Steel Reinforcement: Deliver, store, and handle steel reinforcement to prevent bending and damage.
- 1.8 FIELD CONDITIONS
- A. Cold-Weather Placement: Comply with ACI 306.1 and as follows. Protect concrete work from physical damage or reduced strength that could be caused by frost, freezing actions, or low temperatures.
 1. When average high and low temperature is expected to fall below 40 deg F for three successive days, maintain delivered concrete mixture temperature within the temperature range required by ACI 301.

PART 2 - PRODUCTS

- 2.1 CONCRETE, GENERAL
- A. ACI Publications: Comply with the following unless modified by requirements in the Contract Documents:
 1. ACI 301.
 2. ACI 117.
- 2.2 FORM-FACING MATERIALS
- A. Smooth-Formed Finished Concrete: Form-facing panels that provide continuous, true, and smooth concrete surfaces. Furnish in largest practicable sizes to minimize number of joints.
 1. Plywood, metal, or other approved panel materials.

SECTION 033000 – CAST-IN-PLACE CONCRETE

- B. Form-Release Agent: Commercially formulated form-release agent that does not bond with, stain, or adversely affect concrete surfaces and does not impair subsequent treatments of concrete surfaces.

2.3 STEEL REINFORCEMENT

- A. Reinforcing Bars: ASTM A 615/A 615M, Grade 60, deformed.
- B. Plain-Steel Wire: ASTM A 1064/A 1064M, as drawn.

2.4 REINFORCEMENT ACCESSORIES

- A. Bar Supports: Bolsters, chairs, spacers, and other devices for spacing, supporting, and fastening reinforcing bars and welded-wire reinforcement in place. Manufacture bar supports from steel wire, plastic, or precast concrete according to CRSI's "Manual of Standard Practice," of greater compressive strength than concrete and as follows:

2.5 CONCRETE MATERIALS

- A. Cementitious Materials:
 - 1. Portland Cement: ASTM C 150/C 150M, Type I/II, gray.
- B. Normal-Weight Aggregates: ASTM C 33/C 33M, coarse aggregate or better, graded. Provide aggregates from a single source.
 - 1. Maximum Coarse-Aggregate Size: 3/4 inch nominal.
 - 2. Fine Aggregate: Free of materials with deleterious reactivity to alkali in cement.
- C. Air-Entraining Admixture: ASTM C 260/C 260M.
- D. Chemical Admixtures: Certified by manufacturer to be compatible with other admixtures and that do not contribute water-soluble chloride ions exceeding those permitted in hardened concrete. Do not use calcium chloride or admixtures containing calcium chloride.
 - 1. Water-Reducing Admixture: ASTM C 494/C 494M, Type A.
 - 2. High-Range, Water-Reducing Admixture: ASTM C 494/C 494M, Type F.
- E. Water: ASTM C 94/C 94M and potable.

2.6 CURING MATERIALS

- A. Evaporation Retarder: Waterborne, monomolecular film forming, manufactured for application to fresh concrete.
- B. Moisture-Retaining Cover: ASTM C 171, polyethylene film or white burlap-polyethylene sheet.

SECTION 033000 – CAST-IN-PLACE CONCRETE

- C. Water: Potable.
- D. Clear, Waterborne, Membrane-Forming Curing Compound: ASTM C 309, Type 1, Class B, nondissipating, certified by curing compound manufacturer to not interfere with bonding of floor covering.

2.7 CONCRETE MIXTURES, GENERAL

- A. Prepare design mixtures for each type and strength of concrete, proportioned on the basis of laboratory trial mixture or field test data, or both, according to ACI 301.
 - 1. Use a qualified independent testing agency for preparing and reporting proposed mixture designs based on laboratory trial mixtures.
- B. Admixtures: Use admixtures according to manufacturer's written instructions.
 - 1. Use water-reducing admixture in concrete, as required, for placement and workability.
- C. Color Pigment: Add color pigment to concrete mixture according to manufacturer's written instructions and to result in hardened concrete color consistent with approved mockup.

2.8 CONCRETE MIXTURES FOR BUILDING ELEMENTS

- A. Slabs: Normal-weight concrete.
 - 1. Minimum Compressive Strength: 4000 psi at 28 days.
 - 2. Maximum W/C Ratio: 0.50.
 - 3. Slump Limit: 4 inches, plus or minus 1 inch.
 - 4. Air Content: Do not allow air content of trowel-finished floors to exceed 3 percent.
- B. Fabricate steel reinforcement according to CRSI's "Manual of Standard Practice."

2.9 CONCRETE MIXING

- A. Ready-Mixed Concrete: Measure, batch, mix, and deliver concrete according to ASTM C 94/C 94M and ASTM C 1116/C 1116M, and furnish batch ticket information.

PART 3 - EXECUTION

3.1 FORMWORK INSTALLATION

- A. Design, erect, shore, brace, and maintain formwork, according to ACI 301, to support vertical, lateral, static, and dynamic loads, and construction loads that might be applied, until structure can support such loads.

SECTION 033000 – CAST-IN-PLACE CONCRETE

- B. Construct formwork so concrete members and structures are of size, shape, alignment, elevation, and position indicated, within tolerance limits of ACI 117.
- C. Construct forms tight enough to prevent loss of concrete mortar.
- D. Construct forms for easy removal without hammering or prying against concrete surfaces. Provide crush or wrecking plates where stripping may damage cast-concrete surfaces. Provide top forms for inclined surfaces steeper than 1.5 horizontal to 1 vertical.
- E. Set edge forms, bulkheads, and intermediate screed strips for slabs to achieve required elevations and slopes in finished concrete surfaces. Provide and secure units to support screed strips; use strike-off templates or compacting-type screeds.
- F. Clean forms and adjacent surfaces to receive concrete. Remove chips, wood, sawdust, dirt, and other debris just before placing concrete.
- G. Coat contact surfaces of forms with form-release agent, according to manufacturer's written instructions, before placing reinforcement.

3.2 STEEL REINFORCEMENT INSTALLATION

- A. General: Comply with CRSI's "Manual of Standard Practice" for fabricating, placing, and supporting reinforcement.
- B. Clean reinforcement of loose rust and mill scale, earth, ice, and other foreign materials that reduce bond to concrete.
- C. Accurately position, support, and secure reinforcement against displacement. Locate and support reinforcement with bar supports to maintain minimum concrete cover. Do not tack weld crossing reinforcing bars.
- D. Set wire ties with ends directed into concrete, not toward exposed concrete surfaces.

3.3 CONCRETE PLACEMENT

- A. Before placing concrete, verify that installation of formwork, reinforcement, and embedded items is complete and that required inspections are completed.
- B. Do not add water to concrete during delivery, at Project site, or during placement unless approved by Architect.
- C. Deposit and consolidate concrete for floors and slabs in a continuous operation, within limits of construction joints, until placement of a panel or section is complete.
 - 1. Consolidate concrete during placement operations, so concrete is thoroughly worked around reinforcement and other embedded items and into corners.
 - 2. Maintain reinforcement in position on chairs during concrete placement.
 - 3. Screed slab surfaces with a straightedge and strike off to correct elevations.
 - 4. Slope surfaces uniformly to drains where required.

SECTION 033000 – CAST-IN-PLACE CONCRETE

5. Begin initial floating using bull floats or darbies to form a uniform and open-textured surface plane, before excess bleedwater appears on the surface. Do not further disturb slab surfaces before starting finishing operations.

3.4 FINISHING FORMED SURFACES

- A. Smooth-Formed Finish: As-cast concrete texture imparted by form-facing material, arranged in an orderly and symmetrical manner with a minimum of seams. Repair and patch tie holes and defects. Remove fins and other projections that exceed specified limits on formed-surface irregularities.

3.5 FINISHING FLOORS AND SLABS

- A. General: Comply with ACI 302.1R recommendations for screeding, restraightening, and finishing operations for concrete surfaces. Do not wet concrete surfaces.
- B. Float Finish: Consolidate surface with power-driven floats or by hand floating if area is small or inaccessible to power-driven floats. Restraighten, cut down high spots, and fill low spots. Repeat float passes and restraightening until surface is left with a uniform, smooth, granular texture.
 1. Apply float finish to surfaces to receive trowel finish.
- C. Trowel Finish: After applying float finish, apply first troweling and consolidate concrete by hand or power-driven trowel. Continue troweling passes and restraighten until surface is free of trowel marks and uniform in texture and appearance. Grind smooth any surface defects that would telegraph through applied coatings or floor coverings.
 1. Apply a trowel finish to surfaces to be covered with resilient flooring, carpet, ceramic or quarry tile set over a cleavage membrane, paint, or another thin-film-finish coating system.
 2. Finish and measure surface, so gap at any point between concrete surface and an unlevelled, freestanding, 10-ft.- long straightedge resting on two high spots and placed anywhere on the surface does not exceed 1/8 inch.

3.6 MISCELLANEOUS CONCRETE ITEM INSTALLATION

- A. Filling In: Fill in holes and openings left in concrete structures after work of other trades is in place unless otherwise indicated. Mix, place, and cure concrete, as specified, to blend with in-place construction. Provide other miscellaneous concrete filling indicated or required to complete the Work.
- B. Curbs: Provide monolithic finish to interior curbs by stripping forms while concrete is still green and by steel-troweling surfaces to a hard, dense finish with corners, intersections, and terminations slightly rounded.
- C. Equipment Bases and Foundations:

SECTION 033000 – CAST-IN-PLACE CONCRETE

1. Coordinate sizes and locations of concrete bases with actual equipment provided.
2. Construct concrete bases 4 inches high unless otherwise indicated, and extend base not less than 6 inches in each direction beyond the maximum dimensions of supported equipment unless otherwise indicated or unless required for seismic anchor support.
3. Minimum Compressive Strength: 4000 psi at 28 days.

3.7 CONCRETE PROTECTING AND CURING

- A. General: Protect freshly placed concrete from premature drying and excessive cold or hot temperatures. Comply with ACI 306.1 for cold-weather protection and ACI 305.1 for hot-weather protection during curing.
- B. Formed Surfaces: Cure formed concrete surfaces, including underside of beams, supported slabs, and other similar surfaces. If forms remain during curing period, moist cure after loosening forms. If removing forms before end of curing period, continue curing for remainder of curing period.
- C. Unformed Surfaces: Begin curing immediately after finishing concrete. Cure unformed surfaces, including floors and slabs, concrete floor toppings, and other surfaces.
- D. Cure concrete according to ACI 308.1, by one or a combination of the following methods:
 1. Moisture-Retaining-Cover Curing: Cover concrete surfaces with moisture-retaining cover for curing concrete, placed in widest practicable width, with sides and ends lapped at least 12 inches, and sealed by waterproof tape or adhesive. Cure for not less than seven days. Immediately repair any holes or tears during curing period, using cover material and waterproof tape.
 - a. Cure concrete surfaces to receive floor coverings with either a moisture-retaining cover or a curing compound that the manufacturer certifies does not interfere with bonding of floor covering used on Project.
 2. Curing Compound: Apply uniformly in continuous operation by power spray or roller according to manufacturer's written instructions. Recoat areas subjected to heavy rainfall within three hours after initial application. Maintain continuity of coating and repair damage during curing period.
 - a. Removal: After curing period has elapsed, remove curing compound without damaging concrete surfaces by method recommended by curing compound manufacturer unless manufacturer certifies curing compound does not interfere with bonding of floor covering used on Project.

3.8 CONCRETE SURFACE REPAIRS

- A. Defective Concrete: Repair and patch defective areas when approved by Architect. Remove and replace concrete that cannot be repaired and patched to Architect's approval.

SECTION 033000 – CAST-IN-PLACE CONCRETE

- B. Repairing Unformed Surfaces: Test unformed surfaces, such as floors and slabs, for finish and verify surface tolerances specified for each surface. Correct low and high areas. Test surfaces sloped to drain for trueness of slope and smoothness; use a sloped template.
1. Repair finished surfaces containing defects. Surface defects include spalls, popouts, honeycombs, rock pockets, crazing and cracks in excess of 0.01 inch wide or that penetrate to reinforcement or completely through unreinforced sections regardless of width, and other objectionable conditions.
 2. After concrete has cured at least 14 days, correct high areas by grinding.
 3. Correct localized low areas during or immediately after completing surface finishing operations by cutting out low areas and replacing with patching mortar. Finish repaired areas to blend into adjacent concrete.
 4. Correct other low areas scheduled to receive floor coverings with a repair underlayment. Prepare, mix, and apply repair underlayment and primer according to manufacturer's written instructions to produce a smooth, uniform, plane, and level surface. Feather edges to match adjacent floor elevations.
 5. Correct other low areas scheduled to remain exposed with a repair topping. Cut out low areas to ensure a minimum repair topping depth of 1/4 inch to match adjacent floor elevations. Prepare, mix, and apply repair topping and primer according to manufacturer's written instructions to produce a smooth, uniform, plane, and level surface.

3.9 FIELD QUALITY CONTROL

- A. Special Inspections: Owner will engage a qualified testing and inspecting agency to perform field tests and inspections and prepare test reports.
- B. Testing Agency: Engage a qualified testing and inspecting agency to perform tests and inspections and to submit reports.
- C. Inspections:
1. Steel reinforcement placement.
 2. Steel reinforcement welding.
 3. Headed bolts and studs.
 4. Verification of use of required design mixture.
 5. Concrete placement, including conveying and depositing.
 6. Curing procedures and maintenance of curing temperature.
 7. Verification of concrete strength before removal of shores and forms from beams and slabs.
- D. Concrete Tests: Testing of composite samples of fresh concrete obtained according to ASTM C 172/C 172M shall be performed according to the following requirements:
1. Testing Frequency: Obtain one composite sample for each day's pour of each concrete mixture exceeding 5 cu. yd., but less than 25 cu. yd., plus one set for each additional 50 cu. yd. or fraction thereof.
 2. Slump: ASTM C 143/C 143M; one test at point of placement for each composite sample, but not less than one test for each day's pour of each concrete mixture. Perform additional tests when concrete consistency appears to change.

SECTION 033000 – CAST-IN-PLACE CONCRETE

3. Air Content: ASTM C 231/C 231M, pressure method, for normal-weight concrete; one test for each composite sample, but not less than one test for each day's pour of each concrete mixture.
4. Compression Test Specimens: ASTM C 31/C 31M.
 - a. Cast and laboratory cure two sets of two standard cylinder specimens for each composite sample.
5. Compressive-Strength Tests: ASTM C 39/C 39M; test one set of two laboratory-cured specimens at 7 days and one set of two specimens at 28 days.
 - a. Test one set of two field-cured specimens at 7 days and one set of two specimens at 28 days.
 - b. A compressive-strength test shall be the average compressive strength from a set of two specimens obtained from same composite sample and tested at age indicated.
6. Strength of each concrete mixture will be satisfactory if every average of any three consecutive compressive-strength tests equals or exceeds specified compressive strength and no compressive-strength test value falls below specified compressive strength by more than 500 psi.
7. Test results shall be reported in writing to Architect, concrete manufacturer, and Contractor within 48 hours of testing. Reports of compressive-strength tests shall contain Project identification name and number, date of concrete placement, name of concrete testing and inspecting agency, location of concrete batch in Work, design compressive strength at 28 days, concrete mixture proportions and materials, compressive breaking strength, and type of break for both 7- and 28-day tests.
8. Additional testing and inspecting, at Contractor's expense, will be performed to determine compliance of replaced or additional work with specified requirements.
9. Correct deficiencies in the Work that test reports and inspections indicate do not comply with the Contract Documents.

END OF SECTION 033000

SECTION 072100 - THERMAL INSULATION

PART 1 - GENERAL

1.1 RELATED DOCUMENTS

- A. Drawings and general provisions of the Contract, including General and Supplementary Conditions and Division 01 Specification Sections, apply to this Section.

1.2 SUMMARY

- A. Section Includes:
 - 1. Foam-plastic board insulation
 - 2. Glass-fiber blanket.

1.3 SUBMITTALS

- A. Product Data: For each type of product.
- B. Product Test Reports: For each product, for tests performed by a qualified testing agency.
- C. Evaluation Reports: For foam-plastic insulation, from ICC-ES.

1.4 DELIVERY, STORAGE, AND HANDLING

- A. Protect insulation materials from physical damage and from deterioration due to moisture, soiling, and other sources. Store inside and in a dry location. Comply with manufacturer's written instructions for handling, storing, and protecting during installation.
- B. Protect foam-plastic board insulation as follows:
 - 1. Do not expose to sunlight except to necessary extent for period of installation and concealment.
 - 2. Protect against ignition at all times. Do not deliver foam-plastic board materials to Project site until just before installation time.
 - 3. Quickly complete installation and concealment of foam-plastic board insulation in each area of construction.

PART 2 - PRODUCTS

2.1 FOAM-PLASTIC BOARD INSULATION

SECTION 072100 - THERMAL INSULATION

- A. Molded Polystyrene Board: ASTM C 578, of type and minimum compressive strength indicated below, with maximum flame-spread and smoke-developed indexes of 75 and 450, respectively, per ASTM E84
 - 1. Manufacturer's: Subject to compliance with requirements, provide products by one of the following:
 - a. Insulfoam LLC
 - b. DiversiFoam Products
 - c. Plymouth Foam, Inc.
 - 2. Type II, 15psi, at roof insulation and where indicated on Drawings.
 - 3. Type IX, 25 psi, at decks/roof decks and where indicated on Drawings.

2.2 GLASS-FIBER BLANKET

- A. Glass-Fiber Blanket, Unfaced: ASTM C 665, Type I; with maximum flame-spread and smoke-developed indexes of 25 and 50, respectively, per ASTM E 84; passing ASTM E 136 for combustion characteristics.
- B. Sustainability Requirements: Provide glass-fiber blanket insulation as follows:
 - 1. Free of Formaldehyde: Insulation manufactured with 100 percent acrylic binders and no formaldehyde.
 - 2. Low Emitting: Insulation tested according to ASTM D 5116 and shown to emit less than 0.05-ppm formaldehyde.
- C. Manufacturers: Subject to compliance with requirements, provide products by one of the following:
 - a. Certainteed; SAINT-GOBAIN.
 - b. Johns Manville; a Berkshire Hathaway company.
 - c. Knauf Insulation.
 - d. Owens Corning.

PART 3 - EXECUTION

3.1 PREPARATION

- A. Clean substrates of substances that are harmful to insulation, including removing projections capable of puncturing insulation or vapor retarders, or that interfere with insulation attachment.

3.2 INSTALLATION, GENERAL

- A. Comply with insulation manufacturer's written instructions applicable to products and applications.
- B. Install insulation that is undamaged, dry, and unsoiled and that has not been left exposed to ice, rain, or snow at any time.
- C. Extend insulation to envelop entire area to be insulated. Fit tightly around obstructions and fill voids with insulation. Remove projections that interfere with placement.

SECTION 072100 - THERMAL INSULATION

- D. Provide sizes to fit applications and selected from manufacturer's standard thicknesses, widths, and lengths. Apply single layer of insulation units unless multiple layers are otherwise shown or required to make up total thickness or to achieve R-value.

3.3 INSTALLATION OF INSULATION IN FRAMED CONSTRUCTION

- A. Blanket Insulation: Install in cavities formed by framing members according to the following requirements:
 - 1. Use insulation widths and lengths that fill the cavities formed by framing members. If more than one length is required to fill the cavities, provide lengths that will produce a snug fit between ends.
 - 2. Place insulation in cavities formed by framing members to produce a friction fit between edges of insulation and adjoining framing members.
 - 3. Maintain 3-inch clearance of insulation around recessed lighting fixtures not rated for or protected from contact with insulation.
 - 4. Attics: Install eave ventilation troughs between roof framing members in insulated attic spaces at vented eaves.
 - 5. For metal-framed wall cavities where cavity heights exceed 96 inches, support unfaced blankets mechanically and support faced blankets by taping flanges of insulation to flanges of metal studs.
- B. Miscellaneous Voids: Install insulation in miscellaneous voids and cavity spaces where required to prevent gaps in insulation using the following materials:
 - 1. Glass-Fiber Insulation: Compact to approximately 40 percent of normal maximum volume equaling a density of approximately 2.5 lb/cu. ft.

3.4 PROTECTION

- A. Protect installed insulation from damage due to harmful weather exposures, physical abuse, and other causes. Provide temporary coverings or enclosures where insulation is subject to abuse and cannot be concealed and protected by permanent construction immediately after installation.

END OF SECTION 072100

SECTION 072600 - VAPOR RETARDERS

PART 1 - GENERAL

1.1 RELATED DOCUMENTS

- A. Drawings and general provisions of the Contract, including General and Supplementary Conditions and Division 01 Specification Sections, apply to this Section.

1.2 SUMMARY

A. Section Includes:

1. Polyethylene vapor retarders.
2. Fire-retardant, reinforced-polyethylene vapor retarders.

B. Related Requirements:

1. Section 072100 "Thermal Insulation" for vapor retarders integral with insulation products.

1.3 ACTION SUBMITTALS

- A. Product Data: For each type of product.

1.4 INFORMATIONAL SUBMITTALS

- A. Product Test Reports: For each product, for tests performed by a qualified testing agency.

PART 2 - PRODUCTS – to match existing vapor retarder in exterior wall

2.1 POLYETHYLENE VAPOR RETARDERS

- A. Polyethylene Vapor Retarders: ASTM D 4397, 10-mil- thick sheet, with maximum permeance rating of 0.13 perm.

2.2 FIRE-RETARDANT, REINFORCED-POLYETHYLENE VAPOR RETARDERS

- A. Fire-Retardant, Reinforced-Polyethylene Vapor Retarders: Sheet with outer layers of polyethylene film laminated to an inner reinforcing layer consisting of either nonwoven grid of nylon cord or polyester scrim and weighing not less than 20 lb/1000 sq. ft., with maximum permeance rating of 0.1 perm.

SECTION 072600 - VAPOR RETARDERS

1. Surface-Burning Characteristics: Maximum flame-spread and smoke-developed indexes of 75 and 200, respectively, per ASTM E 84.

2.3 ACCESSORIES

- A. Vapor-Retarder Tape: Pressure-sensitive tape of type recommended by vapor-retarder manufacturer for sealing joints and penetrations in vapor retarder.
- B. Adhesive for Vapor Retarders: Product recommended by vapor-retarder manufacturer and has demonstrated capability to bond vapor retarders securely to substrates indicated.
- C. Vapor-Retarder Fasteners: Pancake-head, self-tapping steel drill screws; with fender washers.

PART 3 - EXECUTION

3.1 PREPARATION

- A. Clean substrates of substances that are harmful to vapor retarders, including removing projections capable of puncturing vapor retarders.

3.2 INSTALLATION OF VAPOR RETARDERS ON FRAMING

- A. Place vapor retarders on side of construction indicated on Drawings.
- B. Extend vapor retarders to extremities of areas to protect from vapor transmission. Secure vapor retarders in place with adhesives, vapor retarder fasteners, or other anchorage system as recommended by manufacturer. Extend vapor retarders to cover miscellaneous voids in insulated substrates, including those filled with loose-fiber insulation.
- C. Seal vertical joints in vapor retarders over framing by lapping no fewer than two studs and sealing with vapor-retarder tape according to vapor-retarder manufacturer's written instructions. Locate all joints over framing members or other solid substrates.
- D. Seal joints caused by pipes, conduits, electrical boxes, and similar items penetrating vapor retarders with vapor-retarder tape to create an airtight seal between penetrating objects and vapor retarders.
- E. Repair tears or punctures in vapor retarders immediately before concealment by other work. Cover with vapor-retarder tape or another layer of vapor retarders.

3.3 PROTECTION

- A. Protect vapor retarders from damage until concealed by permanent construction.

END OF SECTION 072600

SECTION 079200 - JOINT SEALANTS

PART 1 - GENERAL

1.1 RELATED DOCUMENTS

- A. Drawings and general provisions of the Contract, including General and Supplementary Conditions and Division 01 Specification Sections, apply to this Section.

1.2 SUMMARY

- A. Section Includes:
 - 1. Silicone joint sealants.
 - 2. Urethane joint sealants.
 - 3. Latex joint sealants.

1.3 SUBMITTALS

- A. Product Data: For each joint-sealant product.
- B. Joint-Sealant Schedule: Include the following information:
 - 1. Joint-sealant application, joint location, and designation.
 - 2. Joint-sealant manufacturer and product name.
 - 3. Joint-sealant formulation.
 - 4. Joint-sealant color.
- C. Product Test Reports: For each kind of joint sealant, for tests performed by a qualified testing agency.

1.4 QUALITY ASSURANCE

- A. Installer Qualifications: An authorized representative who is trained and approved by manufacturer.
- B. Product Testing: Test joint sealants using a qualified testing agency.
 - 1. Testing Agency Qualifications: Qualified according to ASTM C 1021 to conduct the testing indicated.
- C. Mockups: Install sealant in mockups of assemblies specified in other Sections that are indicated to receive joint sealants specified in this Section. Use materials and installation methods specified in this Section.

1.5 PRECONSTRUCTION TESTING

- A. Preconstruction Laboratory Testing: Submit to joint-sealant manufacturers, for testing indicated below, samples of materials that will contact or affect joint sealants.
 - 1. Adhesion Testing: Use ASTM C 794 to determine whether priming and other specific joint preparation techniques are required to obtain rapid, optimum adhesion of joint sealants to joint substrates.

SECTION 079200 - JOINT SEALANTS

2. Compatibility Testing: Use ASTM C 1087 to determine sealant compatibility when in contact with glazing and gasket materials.
3. Submit manufacturer's recommended number of pieces of each type of material, including joint substrates, joint-sealant backings, and miscellaneous materials.
4. Schedule sufficient time for testing and analyzing results to prevent delaying the Work.
5. For materials failing tests, obtain joint-sealant manufacturer's written instructions for corrective measures, including use of specially formulated primers.
6. Testing will not be required if joint-sealant manufacturers submit data that are based on previous testing, not older than 24 months, of sealant products for adhesion to, staining of, and compatibility with joint substrates and other materials matching those submitted.

1.6 FIELD CONDITIONS

- A. Do not proceed with installation of joint sealants under the following conditions:
 1. When ambient and substrate temperature conditions are outside limits permitted by joint-sealant manufacturer or are below 40 deg F.
 2. When joint substrates are wet.
 3. Where joint widths are less than those allowed by joint-sealant manufacturer for applications indicated.
 4. Where contaminants capable of interfering with adhesion have not yet been removed from joint substrates.

1.7 WARRANTY

- A. Special Installer's Warranty: Installer agrees to repair or replace joint sealants that do not comply with performance and other requirements specified in this Section within specified warranty period.
 1. Warranty Period: Two years from date of Substantial Completion.
- B. Special Manufacturer's Warranty: Manufacturer agrees to furnish joint sealants to repair or replace those joint sealants that do not comply with performance and other requirements specified in this Section within specified warranty period.
 1. Warranty Period: Five years from date of Substantial Completion.
- C. Special warranties specified in this article exclude deterioration or failure of joint sealants from the following:
 1. Movement of the structure caused by stresses on the sealant exceeding sealant manufacturer's written specifications for sealant elongation and compression.
 2. Disintegration of joint substrates from causes exceeding design specifications.
 3. Mechanical damage caused by individuals, tools, or other outside agents.
 4. Changes in sealant appearance caused by accumulation of dirt or other atmospheric contaminants.

SECTION 079200 - JOINT SEALANTS

PART 2 - PRODUCTS

2.1 JOINT SEALANTS, GENERAL

- A. Compatibility: Provide joint sealants, backings, and other related materials that are compatible with one another and with joint substrates under conditions of service and application, as demonstrated by joint-sealant manufacturer, based on testing and field experience.
- B. Colors of Exposed Joint Sealants: As selected by Architect from manufacturer's full range.

2.2 SILICONE JOINT SEALANTS

- A. Silicone, Mildew Resistant, Acid Curing, S, NS, 25, NT: Mildew-resistant, single-component, nonsag, plus 25 percent and minus 25 percent movement capability, nontraffic-use, acid-curing silicone joint sealant; ASTM C 920, Type S, Grade NS, Class 25, Use NT.
 - 1. Joint Locations:
 - a. Joints between plumbing fixtures and adjoining walls, floors, and counters.
 - b. Interior sealant joints subject to moisture.
 - 2. Manufacturers: Subject to compliance with requirements, available manufacturers offering products that may be incorporated into the Work include, but are not limited to the following:
 - a. BASF Corporation; Construction Systems.
 - b. Pecora Corporation.
 - c. Sika Corporation; Joint Sealants.

2.3 URETHANE JOINT SEALANTS

- A. Urethane, M, NS, 25, T, NT: Multicomponent, nonsag, plus 25 percent and minus 25 percent movement capability, traffic- and nontraffic-use, urethane joint sealant; ASTM C 920, Type M, Grade NS, Class 25, Uses T and NT.
 - 1. Joint Locations:
 - a. Control joints in tile flooring.
 - 2. Manufacturers: Subject to compliance with requirements, available manufacturers offering products that may be incorporated into the Work include, but are not limited to the following:
 - a. BASF Corporation; Construction Systems.
 - b. Pecora Corporation.
 - c. Sika Corporation; Joint Sealants.

2.4 LATEX JOINT SEALANTS

- A. Acrylic Latex: Acrylic latex or siliconized acrylic latex, ASTM C 834, Type OP, Grade NF.
 - 1. Joint Locations:
 - a. Joints between interior wall surfaces and frames of interior doors and windows.
 - b. Other joints as indicated.

SECTION 079200 - JOINT SEALANTS

2. Manufacturers: Subject to compliance with requirements, provide products by one of the following:
 - a. Everkem Diversified Products, Inc.
 - b. Franklin International.
 - c. Pecora Corporation.

2.5 JOINT-SEALANT BACKING

- A. Sealant Backing Material, General: Nonstaining; compatible with joint substrates, sealants, primers, and other joint fillers; and approved for applications indicated by sealant manufacturer based on field experience and laboratory testing.
- B. Cylindrical Sealant Backings: ASTM C 1330, Type C (closed-cell material with a surface skin); Type O (open-cell material); Type B (bicellular material with a surface skin) or any of the preceding types, as approved in writing by joint-sealant manufacturer for joint application indicated, and of size and density to control sealant depth and otherwise contribute to producing optimum sealant performance.
- C. Bond-Breaker Tape: Polyethylene tape or other plastic tape recommended by sealant manufacturer for preventing sealant from adhering to rigid, inflexible joint-filler materials or joint surfaces at back of joint. Provide self-adhesive tape where applicable.

2.6 MISCELLANEOUS MATERIALS

- A. Primer: Material recommended by joint-sealant manufacturer where required for adhesion of sealant to joint substrates indicated, as determined from preconstruction joint-sealant-substrate tests and field tests.
- B. Cleaners for Nonporous Surfaces: Chemical cleaners acceptable to manufacturers of sealants and sealant backing materials, free of oily residues or other substances capable of staining or harming joint substrates and adjacent nonporous surfaces in any way, and formulated to promote optimum adhesion of sealants to joint substrates.
- C. Masking Tape: Nonstaining, nonabsorbent material compatible with joint sealants and surfaces adjacent to joints.

PART 3 - EXECUTION

3.1 EXAMINATION

- A. Examine joints indicated to receive joint sealants, with Installer present, for compliance with requirements for joint configuration, installation tolerances, and other conditions affecting performance of the Work.
- B. Proceed with installation only after unsatisfactory conditions have been corrected.

SECTION 079200 - JOINT SEALANTS

3.2 PREPARATION

- A. Surface Cleaning of Joints: Clean out joints immediately before installing joint sealants to comply with joint-sealant manufacturer's written instructions and the following requirements.
 - 1. Remove all foreign material from joint substrates that could interfere with adhesion of joint sealant, including dust, paints (except for permanent, protective coatings tested and approved for sealant adhesion and compatibility by sealant manufacturer), old joint sealants, oil, grease, waterproofing, water repellents, water, surface dirt, and frost.
 - 2. Clean porous joint substrate surfaces by brushing, grinding, mechanical abrading, or a combination of these methods to produce a clean, sound substrate capable of developing optimum bond with joint sealants. Remove loose particles remaining after cleaning operations above by vacuuming or blowing out joints with oil-free compressed air.
 - 3. Clean nonporous joint substrate surfaces with chemical cleaners or other means that do not stain, harm substrates, or leave residues capable of interfering with adhesion of joint sealants.
- B. Joint Priming: Prime joint substrates where recommended by joint-sealant manufacturer or as indicated by preconstruction joint-sealant-substrate tests or prior experience. Apply primer to comply with joint-sealant manufacturer's written instructions. Confine primers to areas of joint-sealant bond; do not allow spillage or migration onto adjoining surfaces.
- C. Masking Tape: Use masking tape where required to prevent contact of sealant or primer with adjoining surfaces that otherwise would be permanently stained or damaged by such contact or by cleaning methods required to remove sealant smears. Remove tape immediately after tooling without disturbing joint seal.

3.3 INSTALLATION OF JOINT SEALANTS

- A. General: Comply with joint-sealant manufacturer's written installation instructions for products and applications indicated, unless more stringent requirements apply.
- B. Sealant Installation Standard: Comply with recommendations in ASTM C 1193 for use of joint sealants as applicable to materials, applications, and conditions indicated.
- C. Install sealant backings of kind indicated to support sealants during application and at position required to produce cross-sectional shapes and depths of installed sealants relative to joint widths that allow optimum sealant movement capability.
 - 1. Do not leave gaps between ends of sealant backings.
 - 2. Do not stretch, twist, puncture, or tear sealant backings.
 - 3. Remove absorbent sealant backings that have become wet before sealant application, and replace them with dry materials.
- D. Install bond-breaker tape behind sealants where sealant backings are not used between sealants and backs of joints.
- E. Install sealants using proven techniques that comply with the following and at the same time backings are installed:
 - 1. Place sealants so they directly contact and fully wet joint substrates.
 - 2. Completely fill recesses in each joint configuration.

SECTION 079200 - JOINT SEALANTS

3. Produce uniform, cross-sectional shapes and depths relative to joint widths that allow optimum sealant movement capability.
- F. Tooling of Nonsag Sealants: Immediately after sealant application and before skinning or curing begins, tool sealants according to requirements specified in subparagraphs below to form
- G. smooth, uniform beads of configuration indicated; to eliminate air pockets; and to ensure contact and adhesion of sealant with sides of joint.
1. Remove excess sealant from surfaces adjacent to joints.
 2. Use tooling agents that are approved in writing by sealant manufacturer and that do not discolor sealants or adjacent surfaces.
 3. Provide concave joint profile per Figure 8A in ASTM C 1193 unless otherwise indicated.
- 3.4 CLEANING
- A. Clean off excess sealant or sealant smears adjacent to joints as the Work progresses by methods and with cleaning materials approved in writing by manufacturers of joint sealants and of products in which joints occur.
- 3.5 PROTECTION
- A. Protect joint sealants during and after curing period from contact with contaminating substances and from damage resulting from construction operations or other causes so sealants are without deterioration or damage at time of Substantial Completion. If, despite such protection, damage or deterioration occurs, cut out, remove, and repair damaged or deteriorated joint sealants immediately so installations with repaired areas are indistinguishable from original work.

END OF SECTION

SECTION 081213 - HOLLOW METAL FRAMES

PART 1 - GENERAL

1.1 RELATED DOCUMENTS

- A. Drawings and general provisions of the Contract, including General and Supplementary Conditions and Division 01 Specification Sections, apply to this Section.

1.2 SUMMARY

- A. Section includes hollow-metal frames.
- B. Related Requirements:
 - 1. Section 081416 "Flush Wood Doors" for wood doors installed in hollow-metal frames.
 - 2. Section 087100 "Door Hardware"

1.3 DEFINITIONS

- A. Minimum Thickness: Minimum thickness of base metal without coatings according to NAAMM-HMMA 803 or SDI A250.8.

1.4 COORDINATION

- A. Coordinate anchorage installation for hollow-metal frames. Furnish setting drawings, templates, and directions for installing anchorages, including sleeves, concrete inserts, anchor bolts, and items with integral anchors. Deliver such items to Project site in time for installation.

1.5 SUBMITTALS

- A. Product Data: For each type of product.
 - 1. Include construction details, material descriptions, fire-resistance ratings, and finishes.
- B. Shop Drawings: Include the following:
 - 1. Frame details for each frame type, including dimensioned profiles and metal thicknesses.
 - 2. Locations of reinforcement and preparations for hardware.
 - 3. Details of each different wall opening condition.
 - 4. Details of anchorages, joints, field splices, and connections.
 - 5. Details of moldings, removable stops, and glazing.
 - 6. Details of conduit and preparations for power, signal, and control systems.
- C. Schedule: Provide a schedule of hollow-metal work prepared by or under the supervision of supplier, using same reference numbers for details and openings as those on Drawings. Coordinate with final Door Hardware Schedule.

SECTION 081213 - HOLLOW METAL FRAMES

1.6 DELIVERY, STORAGE, AND HANDLING

- A. Deliver hollow-metal work palletized, packaged, or crated to provide protection during transit and Project-site storage. Do not use nonvented plastic.
 - 1. Provide additional protection to prevent damage to factory-finished units.
- B. Deliver welded frames with two removable spreader bars across bottom of frames, tack welded to jambs and mullions.
- C. Store hollow-metal work vertically under cover at Project site with head up. Place on minimum 4-inch-high wood blocking. Provide minimum 1/4-inch space between each unit to permit air circulation.

PART 2 - PRODUCTS

2.1 MANUFACTURERS

- A. Manufacturers: Subject to compliance with requirements, available manufacturers offering products that may be incorporated into the Work include, but are not limited to, the following:
 - 1. Ceco
 - 2. Curries
 - 3. Steelcraft
 - 4. Republic
- B. Source Limitations: Obtain hollow-metal work from single source from single manufacturer.

2.2 REGULATORY REQUIREMENTS

- A. Fire-Rated Assemblies: Complying with NFPA 80 and listed and labeled by a qualified testing agency acceptable to authorities having jurisdiction for fire-protection ratings indicated, based on testing at positive pressure according to NFPA 252 or UL 10C.
 - 1. Smoke- and Draft-Control Assemblies: Provide an assembly with gaskets listed and labeled for smoke and draft control by a qualified testing agency acceptable to authorities having jurisdiction, based on testing according to UL 1784 and installed in compliance with NFPA 105.
- B. Fire-Rated, Borrowed-Lite Assemblies: Complying with NFPA 80 and listed and labeled by a testing and inspecting agency acceptable to authorities having jurisdiction for fire-protection ratings indicated, based on testing according to NFPA 257 or UL 9.

2.3 INTERIOR FRAMES

- A. Construct interior frames to comply with the standards indicated for materials, fabrication, hardware locations, hardware reinforcement, tolerances, and clearances, and as specified.
- B. Heavy-Duty Frames: SDI A250.8, Level 2..
 - 1. Physical Performance: Level B according to SDI A250.4.
 - 2. Materials: Uncoated steel sheet, minimum thickness of 0.053 inch.
 - 3. Construction: Face welded.
 - 4. Exposed Finish: Prime.

SECTION 081213 - HOLLOW METAL FRAMES

2.4 FRAME ANCHORS

- A. Jamb Anchors:
 - 1. Stud-Wall Type: Designed to engage stud, welded to back of frames; not less than 0.042 inch thick.
- B. Floor Anchors: Formed from same material as frames, minimum thickness of 0.042 inch, and as follows:
 - 1. Monolithic Concrete Slabs: Clip-type anchors, with two holes to receive fasteners.
 - 2. Separate Topping Concrete Slabs: Adjustable-type anchors with extension clips, allowing not less than 2-inch height adjustment. Terminate bottom of frames at finish floor surface.

2.5 MATERIALS

- A. Cold-Rolled Steel Sheet: ASTM A 1008/A 1008M, Commercial Steel (CS), Type B; suitable for exposed applications.
- B. Hot-Rolled Steel Sheet: ASTM A 1011/A 1011M, Commercial Steel (CS), Type B; free of scale, pitting, or surface defects; pickled and oiled.
- C. Metallic-Coated Steel Sheet: ASTM A 653/A 653M, Commercial Steel (CS), Type B.
- D. Frame Anchors: ASTM A 879/A 879M, Commercial Steel (CS), 04Z coating designation; mill phosphatized.
 - 1. For anchors built into exterior walls, steel sheet complying with ASTM A 1008/A 1008M or ASTM A 1011/A 1011M, hot-dip galvanized according to ASTM A 153/A 153M, Class B.
- E. Inserts, Bolts, and Fasteners: Hot-dip galvanized according to ASTM A 153/A 153M.
- F. Power-Actuated Fasteners in Concrete: Fastener system of type suitable for application indicated, fabricated from corrosion-resistant materials, with clips or other accessory devices for attaching hollow-metal frames of type indicated.
- G. Mineral-Fiber Insulation: ASTM C 665, Type I (blankets without membrane facing); consisting of fibers manufactured from slag or rock wool with 6- to 12-lb/cu. ft. density; with maximum flame-spread and smoke-developed indexes of 25 and 50, respectively; passing ASTM E 136 for combustion characteristics.
- H. Glazing: Comply with requirements in Section 088000 "Glazing."

2.6 FABRICATION

- A. Fabricate hollow-metal work to be rigid and free of defects, warp, or buckle. Accurately form metal to required sizes and profiles, with minimum radius for metal thickness. Where practical, fit and assemble units in manufacturer's plant. To ensure proper assembly at Project site, clearly identify work that cannot be permanently factory assembled before shipment.

SECTION 081213 - HOLLOW METAL FRAMES

- B. Hardware Preparation: Factory prepare hollow-metal work to receive templated mortised hardware; include cutouts, reinforcement, mortising, drilling, and tapping according to SDI A250.6, the Door Hardware Schedule, and templates.
 - 1. Reinforce frames to receive nontemplated, mortised, and surface-mounted hardware.
 - 2. Comply with applicable requirements in SDI A250.6 and BHMA A156.115 for preparation of hollow-metal work for hardware.
 - 3. Factory prepare frames to receive electric strikes.

2.7 STEEL FINISHES

- A. Prime Finish: Clean, pretreat, and apply manufacturer's standard primer.
 - 1. Shop Primer: Manufacturer's standard, fast-curing, lead- and chromate-free primer complying with SDI A250.10; recommended by primer manufacturer for substrate; compatible with substrate and field-applied coatings despite prolonged exposure.

PART 3 - EXECUTION

3.1 EXAMINATION

- A. Examine substrates, areas, and conditions, with Installer present, for compliance with requirements for installation tolerances and other conditions affecting performance of the Work.
- B. Examine roughing-in for embedded and built-in anchors to verify actual locations before frame installation.
- C. Proceed with installation only after unsatisfactory conditions have been corrected.

3.2 PREPARATION

- A. Remove welded-in shipping spreaders installed at factory. Restore exposed finish by grinding, filling, and dressing, as required to make repaired area smooth, flush, and invisible on exposed faces.
- B. Drill and tap frames to receive nontemplated, mortised, and surface-mounted hardware.

3.3 INSTALLATION

- A. General: Install hollow-metal work plumb, rigid, properly aligned, and securely fastened in place. Comply with Drawings and manufacturer's written instructions.
- B. Hollow-Metal Frames: Install hollow-metal frames for doors of size and profile indicated. Comply with SDI A250.11 or NAAMM-HMMA 840 as required by standards specified.
 - 1. Set frames accurately in position; plumbed, aligned, and braced securely until permanent anchors are set. After wall construction is complete, remove temporary braces, leaving surfaces smooth and undamaged.
 - a. At fire-rated openings, install frames according to NFPA 80.
 - b. Install frames with removable stops located on secure side of opening.
 - c. Install door silencers in frames before grouting.
 - d. Remove temporary braces necessary for installation only after frames have been properly set and secured.

SECTION 081213 - HOLLOW METAL FRAMES

- e. Check plumb, square, and twist of frames as walls are constructed. Shim as necessary to comply with installation tolerances.
2. Floor Anchors: Provide floor anchors for each jamb and mullion that extends to floor, and secure with postinstalled expansion anchors.
 - a. Floor anchors may be set with power-actuated fasteners instead of postinstalled expansion anchors if so indicated and approved on Shop Drawings.
3. Metal-Stud Partitions: Solidly pack mineral-fiber insulation inside frames.
4. In-Place Metal Stud Partitions: Secure slip-on drywall frames in place according to manufacturer's written instructions.
5. Installation Tolerances: Adjust hollow-metal door frames for squareness, alignment, twist, and plumb to the following tolerances:
 - a. Squareness: Plus or minus 1/16 inch, measured at door rabbet on a line 90 degrees from jamb perpendicular to frame head.
 - b. Alignment: Plus or minus 1/16 inch, measured at jambs on a horizontal line parallel to plane of wall.
 - c. Twist: Plus or minus 1/16 inch, measured at opposite face corners of jambs on parallel lines, and perpendicular to plane of wall.
 - d. Plumbness: Plus or minus 1/16 inch, measured at jambs at floor.
- C. Glazing: Comply with installation requirements in Section 088000 "Glazing" and with hollow-metal manufacturer's written instructions.
 1. Secure stops with countersunk flat- or oval-head machine screws spaced uniformly not more than 9 inches o.c. and not more than 2 inches o.c. from each corner.

3.4 ADJUSTING AND CLEANING

- A. Final Adjustments: Remove and replace defective work, including hollow-metal work that is warped, bowed, or otherwise unacceptable.
- B. Prime-Coat Touchup: Immediately after erection, sand smooth rusted or damaged areas of prime coat and apply touchup of compatible air-drying, rust-inhibitive primer.
- C. Metallic-Coated Surface Touchup: Clean abraded areas and repair with galvanizing repair paint according to manufacturer's written instructions.
- D. Touchup Painting: Cleaning and touchup painting of abraded areas of paint are specified in painting Sections.

END OF SECTION

SECTION 081213 - HOLLOW METAL FRAMES

THIS PAGE INTENTIONALLY LEFT BLANK

SECTION 081416 - FLUSH WOOD DOORS

PART 1 - GENERAL

1.1 RELATED DOCUMENTS

- A. Drawings and general provisions of the Contract, including General and Supplementary Conditions and Division 01 Specification Sections, apply to this Section.

1.2 SUMMARY

- A. Section Includes:
 - 1. Solid-core doors with wood-veneer faces.
 - 2. Factory fitting flush wood doors to frames and factory machining for hardware.

1.3 SUBMITTALS

- A. Product Data: For each type of door. Include details of core and edge construction and trim for openings. Include factory-finishing specifications.
- B. Shop Drawings: Indicate location, size, and hand of each door; elevation of each kind of door; construction details not covered in Product Data; and the following:
 - 1. Dimensions and locations of blocking.
 - 2. Dimensions and locations of mortises and holes for hardware.
 - 3. Dimensions and locations of cutouts.
 - 4. Undercuts.
 - 5. Requirements for veneer matching.
 - 6. Doors to be factory finished and finish requirements.
 - 7. Fire-protection ratings for fire-rated doors.
- C. Samples for Verification: For factory-finished doors.
- D. Sample Warranty: For special warranty.

1.4 DELIVERY, STORAGE, AND HANDLING

- A. Comply with requirements of referenced standard and manufacturer's written instructions.
- B. Package doors individually in cardboard cartons and wrap bundles of doors in plastic sheeting.
- C. Mark each door on top and bottom rail with opening number used on Shop Drawings.

1.5 FIELD CONDITIONS

- A. Environmental Limitations: Do not deliver or install doors until spaces are enclosed and weathertight, wet work in spaces is complete and dry, and HVAC system is operating and maintaining ambient temperature and humidity conditions at occupancy levels during remainder of construction period.
- B. Environmental Limitations: Do not deliver or install doors until spaces are enclosed and weathertight, wet work in spaces is complete and dry, and HVAC system is operating and

SECTION 081416 - FLUSH WOOD DOORS

maintaining temperature between 60 and 90 deg F and relative humidity between 25 and 55 percent during remainder of construction period.

1.6 WARRANTY

- A. A. Special Warranty: Manufacturer agrees to repair or replace doors that fail in materials or workmanship within specified warranty period.
 - 1. Failures include, but are not limited to, the following:
 - a. Warping (bow, cup, or twist) more than 1/4 inch in a 42-by-84-inch section.
 - b. Telegraphing of core construction in face veneers exceeding 0.01 inch in a 3-inch span.
 - 2. Warranty shall also include installation and finishing that may be required due to repair or replacement of defective doors.
 - 3. Warranty Period for Solid-Core Interior Doors: Life of installation.

PART 2 - PRODUCTS

2.1 FLUSH WOOD DOORS, GENERAL

- A. Quality Standard: In addition to requirements specified, comply with WDMA I.S.1-A, "Architectural Wood Flush Doors."
- B. WDMA I.S.1-A Performance Grade: Extra Heavy Duty.

2.2 VENEER-FACED DOORS FOR TRANSPARENT FINISH

- A. Interior Solid-Core Doors:
 - 1. Grade: Premium, with Grade A faces.
 - 2. Species: Select white oak.
 - 3. Cut: Plain sliced (flat sliced).
 - 4. Match between Veneer Leaves: Book match.
 - 5. Assembly of Veneer Leaves on Door Faces: Running match.
 - 6. Pair and Set Match: Provide for doors hung in same opening.
 - 7. Core: Particleboard.
 - 8. Construction: Five or seven plies. Stiles and rails are bonded to core, then entire unit is abrasive planed before veneering.

2.3 LIGHT FRAMES AND LOUVERS

- A. Wood Beads for Light Openings in Wood Doors: Provide manufacturer's standard wood beads unless otherwise indicated.
 - 1. Wood Species: Same species as door faces.
 - 2. Profile: Flush rectangular beads.
 - 3. At wood-core doors with 20-minute fire-protection ratings, provide wood beads and metal glazing clips approved for such use.
- B. Wood-Veneered Beads for Light Openings in Fire-Rated Doors: Manufacturer's standard wood-veneered noncombustible beads matching veneer species of door faces and approved for use in doors of fire-protection rating indicated. Include concealed metal glazing clips where required for opening size and fire-protection rating indicated.

SECTION 081416 - FLUSH WOOD DOORS

2.4 FABRICATION

- A. Factory fit doors to suit frame-opening sizes indicated. Comply with clearance requirements of referenced quality standard for fitting unless otherwise indicated.
 - 1. Comply with NFPA 80 requirements for fire-rated doors.
- B. Factory machine doors for hardware that is not surface applied. Locate hardware to comply with DHI-WDHS-3. Comply with final hardware schedules, door frame Shop Drawings, BHMA-156.115-W, and hardware templates.
 - 1. Coordinate with hardware mortises in metal frames to verify dimensions and alignment before factory machining.
- C. Openings: Factory cut and trim openings through doors.
 - 1. Light Openings: Trim openings with moldings of material and profile indicated.
 - 2. Glazing: Factory install glazing in doors indicated to be factory finished. Comply with applicable requirements in Section 088000 "Glazing."

2.5 FACTORY FINISHING

- A. General: Comply with referenced quality standard for factory finishing. Complete fabrication, including fitting doors for openings and machining for hardware that is not surface applied, before finishing.
 - 1. Finish faces, all four edges, edges of cutouts, and mortises. Stains and fillers may be omitted on top and bottom edges, edges of cutouts, and mortises.
- B. Factory finish doors.
- C. Transparent Finish:
 - 1. Grade: Custom.
 - 2. Finish: WDMA TR-4 conversion varnish.
 - 3. Effect: Semifilled finish, produced by applying an additional finish coat to partially fill the wood pores.
 - 4. Sheen: Satin.

PART 3 - EXECUTION

3.1 EXAMINATION

- A. Examine doors and installed door frames, with Installer present, before hanging doors.
 - 1. Verify that installed frames comply with indicated requirements for type, size, location, and swing characteristics and have been installed with level heads and plumb jambs.
 - 2. Reject doors with defects.
- B. Proceed with installation only after unsatisfactory conditions have been corrected.

3.2 INSTALLATION

- A. Hardware: For installation, see Section 087100 "Door Hardware."

SECTION 081416 - FLUSH WOOD DOORS

- B. Installation Instructions: Install doors to comply with manufacturer's written instructions and referenced quality standard, and as indicated.
 - 1. Install fire-rated doors according to NFPA 80.
 - 2. Install smoke- and draft-control doors according to NFPA 105.
 - C. Factory-Fitted Doors: Align in frames for uniform clearance at each edge.
 - D. Factory-Finished Doors: Restore finish before installation if fitting or machining is required at Project site.
- 3.3 ADJUSTING
- A. Operation: Rehang or replace doors that do not swing or operate freely.
 - B. Finished Doors: Replace doors that are damaged or that do not comply with requirements. Doors may be repaired or refinished if Work complies with requirements and shows no evidence of repair or refinishing.

END OF SECTION

SECTION 083213 - SLIDING ALUMINUM-FRAMED GLASS DOORS

PART 1 - GENERAL

1.1 RELATED DOCUMENTS

- A. Drawings and general provisions of the Contract, including General and Supplementary Conditions and Division 01 Specification Sections, apply to this Section.

1.2 SUMMARY

- A. Section includes sliding aluminum-framed glass doors for exterior locations.
- B. Related Requirements:
 - 1. Section 087100 "Door Hardware" for hardware not specified in Section 083213.

1.3 ACTION SUBMITTALS

- A. Product Data: For each type of product.
 - 1. Include construction details, material descriptions, fabrication methods, dimensions of individual components and profiles, hardware, finishes, and operating instructions.
- B. Shop Drawings: For sliding aluminum-framed glass doors.
 - 1. Include plans, elevations, sections, and details.
 - 2. Detail attachments to other work, and between units, if any.
 - 3. Include hardware and required clearances.
- C. Product Schedule: For sliding aluminum-framed glass doors.

1.4 INFORMATIONAL SUBMITTALS

- A. Qualification Data: For manufacturer.
- B. Sample Warranty: For manufacturer's special warranty.

1.5 CLOSEOUT SUBMITTALS

- A. Maintenance Data: For finishes, weather stripping, operable panels, and operating hardware to include in maintenance manuals.

SECTION 083213 - SLIDING ALUMINUM-FRAMED GLASS DOORS

1.6 QUALITY ASSURANCE

- A. Manufacturer Qualifications: A manufacturer capable of fabricating sliding aluminum-framed glass doors that meet or exceed performance requirements indicated and of documenting this performance by inclusion in lists and by labels, test reports, and calculations.
- B. Installer Qualifications: An installer acceptable to sliding aluminum-framed glass door manufacturer for installation of units required for this Project.

1.7 WARRANTY

- A. Manufacturer's Special Warranty: Manufacturer agrees to repair or replace components of sliding aluminum-framed glass doors that fail in materials or workmanship within specified warranty period.
 - 1. Failures include, but are not limited to, the following:
 - a. Failure to meet performance requirements.
 - b. Structural failures including excessive deflection.
 - c. Excessive water leakage or air infiltration.
 - d. Faulty operation of movable panels and hardware.
 - e. Deterioration of metals, metal finishes, and other materials beyond normal weathering.
 - 2. Warranty Period:
 - a. Sliding Door: One year from date of Substantial Completion.

PART 2 - PRODUCTS

2.1 MANUFACTURERS

- 1. Basis-of-Design Product is Assa Abloy, subject to compliance with requirements, products by the following are also acceptable:
 - a. dormakaba USA Inc.
 - b. stanley access technologies
- 2. Telescopic single slide, full breakout, ICU/CCU door system.
 - B. Operation: Access Control
 - C. Configuration: Single slide
 - D. Breakaway Capability
 - E. Mounting: Overhead header installed between jambs.

2.2 PERFORMANCE REQUIREMENTS

- A. Product Standard: Comply with AAMA/WDMA/CSA 101/I.S.2/A440 for minimum standards of performance, materials, components, accessories, and fabrication unless more stringent requirements are indicated.

SECTION 083213 - SLIDING ALUMINUM-FRAMED GLASS DOORS

1. Product Certification: AAMA certified with label attached to each door.

B. Performance Class and Grade: AAMA/WDMA/CSA 101/I.S.2/A440 as follows:

1. Minimum Performance Class: Class R.
2. Minimum Performance Grade: Grade 15.

2.3 SLIDING ALUMINUM-FRAMED GLASS DOORS

1. Material: Extruded Aluminum, Alloy 6063-T5 or 6063-T6.
2. Door panels shall have a minimum .125 inch (3.2 mm) structural wall thickness including adjoining perimeter frames where applicable.
 - a. Aluminum extrusions shall allow for a factory installed, slide-in type gasket.
3. Door construction shall be by means of an integrated corner clip with 3/8 inch diameter all-thread through bolt from each stile.
 - a. Face of door stiles shall be flush with adjacent rails and muntin.
4. Glass stops shall be .062 inch (15.8 mm) wall thickness and shall provide security function as a standard by means of a fixed non-removable exterior section with glazing to be performed from the interior only.
 - a. Beveled glass stops.
5. Vertical Stiles shall be narrow stile 2-1/8 inch
6. Bottom Rails shall be 7 inch
7. Intermediate Muntin shall be 1-3/4 inch
8. Gasketing: Slide-in type, replaceable pile mohair seals.
 - a. Bottom rails shall be provided with a concealed adjustable sweep gasket.
9. Glass: Glazing shall comply with ANSI Z97.1, thickness as indicated.

2.4 GLAZING

A. Glass and Glazing: Manufacturer's standard glazing system that produces weathertight seal.

B. Glazing Sliding Panels: 1/4" tempered glass, unless otherwise specified.

1. Safety Glazing Labeling: Permanently mark safety glazing with certification label of the SGCC or another certification agency acceptable to authorities having jurisdiction or the manufacturer. Label shall indicate manufacturer's name, type of glass, thickness, and safety glazing standard with which glass complies.

2.5 HARDWARE

A. General: Provide manufacturer's standard hardware, fabricated from a corrosion-resistant material compatible with aluminum complying with AAMA 907 and designed to smoothly operate, tightly close, and securely lock sliding aluminum-framed glass doors.

B. Door Pulls: Provide manufacturer's standard pull.

1. Color and Finish: Match door frame

SECTION 083213 - SLIDING ALUMINUM-FRAMED GLASS DOORS

- C. Lock: Install manufacturer's keyed cylinder lock and [multipoint] locking device on each movable panel, lockable from the inside [only] [and outside]. Adjust locking device to allow unobstructed movement of the panel across adjacent panel in the direction indicated.

2.6 ACCESSORIES

- A. Fasteners: Noncorrosive and compatible with door members, trim, hardware, anchors, and other components.
 - 1. Exposed Fasteners: Do not use exposed fasteners to the greatest extent possible. For application of hardware, use fasteners that match finish hardware being fastened.
- B. Anchors, Clips, and Accessories: Provide anchors, clips, and accessories of aluminum, nonmagnetic stainless steel, or zinc-coated steel or iron for sliding aluminum-framed glass doors, complying with ASTM B 456 or ASTM B 633 for SC 3 severe service conditions; provide sufficient strength to withstand design pressure indicated.
 - 1. Windborne-Debris Resistance: Provide anchors of same design used in windborne-debris resistance testing.

2.7 FABRICATION

- A. Fabricate sliding aluminum-framed glass doors in sizes indicated. Include a complete system for assembling components and anchoring doors.
- B. Fabricate sliding aluminum-framed glass doors that are reglazable without dismantling panel framing.
- C. Weather Stripping: Provide full-perimeter weather stripping for each door panel.
- D. Weep Holes: Provide weep holes and internal drainage passages to conduct infiltrating water to exterior.
- E. Complete fabrication, assembly, finishing, hardware application, and other work in the factory to greatest extent possible. Disassemble components only as necessary for shipment and installation.
- F. Factory-Glazed Fabrication: Glaze sliding aluminum-framed glass doors in the factory where practical and possible for applications indicated. Comply with requirements in Section 088000 "Glazing" and with AAMA/WDMA/CSA 101/I.S.2/A440.

2.8 GENERAL FINISH REQUIREMENTS

- A. Comply with NAAMM's "Metal Finishes Manual for Architectural and Metal Products" for recommendations for applying and designating finishes.
- B. Protect mechanical finishes on exposed surfaces from damage by applying a strippable, temporary protective covering before shipping.

SECTION 083213 - SLIDING ALUMINUM-FRAMED GLASS DOORS

- C. Appearance of Finished Work: Variations in appearance of abutting or adjacent pieces are acceptable if they are within one-half of the range of approved Samples. Noticeable variations in the same piece are not acceptable. Variations in appearance of other components are acceptable if they are within the range of approved Samples and are assembled or installed to minimize contrast.

2.9 ALUMINUM FINISHES

- A. Clear Anodic Finish: AAMA 611, AA-M12C22A41, Class I, 0.018 mm or thicker.

PART 3 - EXECUTION

3.1 EXAMINATION

- A. Examine openings, substrates, structural support, anchorage, and conditions, with Installer present, for compliance with requirements for installation tolerances and other conditions affecting performance of the Work.
- B. Verify rough opening dimensions, levelness of threshold substrate, and operational clearances.
- C. Examine wall flashings, vapor retarders, water and weather barriers, and other built-in components to ensure a coordinated, weathertight sliding aluminum-framed glass door installation.
- D. Proceed with installation only after unsatisfactory conditions have been corrected.

3.2 INSTALLATION

- A. Comply with Drawings, Shop Drawings, and manufacturer's written instructions for installing doors, hardware, accessories, and other components.
- B. Windborne Debris Resistance: Anchor sliding aluminum-framed glass doors that have been tested for windborne debris resistance to structure using anchoring method, fastener type, and fastening frequency identical to that used in windborne debris resistance testing.
- C. Install sliding aluminum-framed glass doors level, plumb, square, true to line, without distortion, without warp or rack of frames and panels, and without impeding thermal movement; anchored securely in place to structural support; and in proper relation to wall flashing, vapor retarders, air barriers, water/weather barriers, and other adjacent construction.
- D. Set sill members in bed of sealant or with gaskets, as indicated, to provide weathertight construction.
- E. Install sliding aluminum-framed glass doors and components to drain condensation, water penetrating joints, and moisture migrating within doors to the exterior.
- F. Separate aluminum and other corrodible surfaces from sources of corrosion or electrolytic action at points of contact with other materials.

SECTION 083213 - SLIDING ALUMINUM-FRAMED GLASS DOORS

3.3 ADJUSTING, CLEANING, AND PROTECTION

- A. Lubricate hardware and moving parts.
- B. Adjust operating panels and screens to provide a tight fit at contact points and weather stripping for smooth operation, without binding, and a weathertight closure. Adjust hardware for proper alignment, smooth operation, and proper latching without unnecessary force or excessive clearance.
- C. Clean exposed surfaces immediately after installing sliding aluminum-framed glass doors. Avoid damaging protective coatings and finishes. Remove nonpermanent labels, excess sealants, glazing materials, dirt, and other substances.
- D. Remove and replace glass that has been broken, chipped, cracked, abraded, or damaged during construction period.
- E. Protect sliding aluminum-framed glass door surfaces from contact with contaminating substances resulting from construction operations. If contaminating substances contact sliding aluminum-framed glass door surfaces, remove contaminants immediately according to manufacturer's written instructions.
- F. Refinish or replace sliding aluminum-framed glass doors with damaged finishes.
- G. Replace damaged components.

END OF SECTION 083213

SECTION 087100 - DOOR HARDWARE

The manufacturer's representative for the locking and closing devices must inspect and approve, in writing, the installation of their products. Hardware installed incorrectly must be reported to the architect prior to the architect's final punch list.

The manufacturer's representative for the door closing devices must inspect and adjust closers at the completion of the project. The HVAC system must be completed and balanced prior to the closer adjustments.

PART 1 - GENERAL

1.1 RELATED DOCUMENTS

- A. Drawings and general provisions of the Contract, including General and Supplementary Conditions and Division 01 Specification Sections, apply to this Section.

1.2 SUMMARY

- A. Section includes:
1. Mechanical door hardware for the following:
 - a. Swinging doors.
 2. Electrified door hardware.
- B. Related Sections:
1. Section 081213 "Hollow Metal Frames".
 2. Section 081416 "Flush Wood Doors".
 3. Section 281300 "Access Control" for access control devices installed at door openings and provided as part of a security system.

1.3 SUBMITTALS

- A. Product Data: For each type of product indicated. Include construction and installation details, material descriptions, dimensions of individual components and profiles, and finishes.
- B. Shop Drawings: Details of electrified door hardware, indicating the following:
1. Wiring Diagrams: For power, signal, and control wiring and including the following:
 - a. Details of interface of electrified door hardware and building safety and security systems.
 - b. Schematic diagram of systems that interface with electrified door hardware.
 - c. Point-to-point wiring.
 - d. Risers.
 - e. Elevations doors controlled by electrified door hardware.
 2. Operation Narrative: Describe the operation of doors controlled by electrified door hardware.

SECTION 087100 - DOOR HARDWARE

- C. Door Hardware Schedule: Prepared by or under the supervision of Installer's Architectural Hardware Consultant. Coordinate door hardware schedule with doors, frames, and related work to ensure proper size, thickness, hand, function, and finish of door hardware.
1. Submittal Sequence: Submit door hardware schedule concurrent with submissions of Product Data, Samples, and Shop Drawings. Coordinate submission of door hardware schedule with scheduling requirements of other work to facilitate the fabrication of other work that is critical in Project construction schedule.
 2. Format: Use same scheduling sequence and format and use same door numbers as in door hardware schedule in the Contract Documents.
 3. Content: Include the following information:
 - a. Identification number, location, hand, fire rating, size, and material of each door and frame.
 - b. Locations of each door hardware set, cross-referenced to Drawings on floor plans and to door and frame schedule.
 - c. Complete designations, including name and manufacturer, type, style, function, size, quantity, function, and finish of each door hardware product.
 - d. Description of electrified door hardware sequences of operation and interfaces with other building control systems.
 - e. Fastenings and other pertinent information.
 - f. Explanation of abbreviations, symbols, and codes contained in schedule.
 - g. Mounting locations for door hardware.
 - h. List of related door devices specified in other Sections for each door and frame.
- D. Keying Schedule: Prepared by or under the supervision of Installer, detailing Owner's final keying instructions for locks. Include schematic keying diagram and index each key set to unique door designations that are coordinated with the Contract Documents.
- E. Maintenance Data: For each type of door hardware to include in maintenance manuals.
- F. Schedules: Final door hardware and keying schedule.

1.4 QUALITY ASSURANCE

- A. Installer Qualifications: Supplier of products and an employer of workers trained and approved by product manufacturers and an Architectural Hardware Consultant who is available during the course of the Work to consult with Contractor, Architect, and Owner about door hardware and keying.
- B. Architectural Hardware Consultant Qualifications: A person who is experienced in providing consulting services for door hardware installations that are comparable in material, design, and extent to that indicated for this Project and who is currently certified by DHI as follows:
- C. Door Hardware Supplier Qualifications: Experienced commercial door hardware distributors with a minimum 5 years documented experience supplying both mechanical and electromechanical hardware installations comparable in material, design, and extent to that indicated for this Project. Supplier recognized as a factory direct distributor by the

SECTION 087100 - DOOR HARDWARE

manufacturers of the primary materials with a warehousing facility in Project's vicinity. Supplier to have on staff a certified Architectural Hardware Consultant (AHC) available during the course of the Work to consult with Contractor, Architect, and Owner concerning both standard and electromechanical door hardware and keying.

- D. Source Limitations: Obtain each type of door hardware from a single manufacturer.
 - 1. Provide electrified door hardware from same manufacturer as mechanical door hardware, unless otherwise indicated. Manufacturers that perform electrical modifications and that are listed by a testing and inspecting agency acceptable to authorities having jurisdiction are acceptable.
- E. Fire-Rated Door Assemblies: Where fire-rated door assemblies are indicated, provide door hardware rated for use in assemblies complying with NFPA 80 that are listed and labeled by a qualified testing agency, for fire-protection ratings indicated, based on testing at positive pressure according to NFPA 252 or UL 10C, unless otherwise indicated.
- F. Smoke- and Draft-Control Door Assemblies: Where smoke- and draft-control door assemblies are required, provide door hardware that meet requirements of assemblies tested according to UL 1784 and installed in compliance with NFPA 105.
 - 1. Air Leakage Rate: Maximum air leakage of 0.3 cfm/sq. ft. at the tested pressure differential of 0.3-inch wg of water.
- G. Electrified Door Hardware: Listed and labeled as defined in NFPA 70, Article 100, by a testing agency acceptable to authorities having jurisdiction.
- H. Means of Egress Doors: Latches do not require more than 15 lbf to release the latch. Locks do not require use of a key, tool, or special knowledge for operation.
- I. Accessibility Requirements: Comply with applicable provisions in the DOJ's 2010 ADA Standards for Accessible Design and ICC A117.1 for door hardware on doors in an accessible route.
 - 1. Provide operating devices that do not require tight grasping, pinching, or twisting of the wrist and that operate with a force of not more than 5 lbf.
 - 2. Comply with the following maximum opening-force requirements:
 - a. Interior, Non-Fire-Rated Hinged Doors: 5 lbf applied perpendicular to door.
 - b. Sliding or Folding Doors: 5 lbf applied parallel to door at latch.
 - c. Fire Doors: Minimum opening force allowable by authorities having jurisdiction.
 - 3. Bevel raised thresholds with a slope of not more than 1:2. Provide thresholds not more than 1/2 inch high.
 - 4. Closers: Adjust door and gate closer sweep periods so that, from an open position of 90 degrees, the time required to move the door to a position of 12 degrees from the latch is 5 seconds minimum.
 - 5. Spring Hinges: Adjust door and gate spring hinges so that, from an open position of 70 degrees, the time required to move the door to the closed position is 1.5 seconds minimum.
- J. Keying Conference: Conduct conference at Project site.
 - 1. Conference participants shall include Installer's Architectural Hardware Consultant and Owner's security consultant

SECTION 087100 - DOOR HARDWARE

2. Incorporate conference decisions into keying schedule after reviewing door hardware keying system including, but not limited to, the following:
 - a. Function of building, purpose of each area and degree of security required.
 - b. Plans for existing and future key system expansion.
 - c. Requirements for key control storage and software.
 - d. Installation of permanent keys, cylinder cores and software.
 - e. Address for delivery of keys.

1.5 DELIVERY, STORAGE, AND HANDLING

- A. Inventory door hardware on receipt and provide secure lock-up for door hardware delivered to Project site.
- B. Tag each item or package separately with identification coordinated with the final door hardware schedule, and include installation instructions, templates, and necessary fasteners with each item or package.
- C. Deliver keys to manufacturer of key control system for subsequent delivery to Owner.

1.6 COORDINATION

- A. Coordinate layout and installation of floor-recessed door hardware with floor construction. Cast anchoring inserts into concrete.
- B. Installation Templates: Distribute for doors, frames, and other work specified to be factory prepared. Check Shop Drawings of other work to confirm that adequate provisions are made for locating and installing door hardware to comply with indicated requirements.
- C. Security: Coordinate installation of door hardware, keying, and access control with Owner's security consultant.
- D. Electrical System Roughing-In: Coordinate layout and installation of electrified door hardware with connections to power supplies and building safety and security systems.
- E. Existing Openings: Where hardware components are scheduled for application to existing construction or where modifications to existing door hardware are required, field verify existing conditions and coordinate installation of door hardware to suit opening conditions and to provide proper door operation.
- F. Coordinate electrified door hardware and components with access control system (ACS) provider under division 28 and verify compatibility and sequence of operation of hardware provided with ACS. Coordinate equipment provided under div 8 with equipment provided under div 28 to prevent duplicates.

1.7 WARRANTY

- A. Special Warranty: Manufacturer's standard form in which manufacturer agrees to repair or replace components of door hardware that fail in materials or workmanship within specified warranty period.

SECTION 087100 - DOOR HARDWARE

1. Failures include, but are not limited to, the following:
 - a. Structural failures including excessive deflection, cracking, or breakage.
 - b. Faulty operation of doors and door hardware.
 - c. Deterioration of metals, metal finishes, and other materials beyond normal weathering and use.
2. Warranty Period: Three years from date of Substantial Completion, unless otherwise indicated.
 - a. Locks: 10 years from the date of Substantial Completion
 - b. Exit Devices: Five years from date of Substantial Completion.
 - c. Manual Closers: 25 years from date of Substantial Completion.

1.8 MAINTENANCE SERVICE

- A. Maintenance Tools and Instructions: Furnish a complete set of specialized tools and maintenance instructions for Owner's continued adjustment, maintenance, and removal and replacement of door hardware.
- B. Maintenance Service: Beginning at Substantial Completion, provide six months' full maintenance by skilled employees of door hardware Installer. Include quarterly preventive maintenance, repair or replacement of worn or defective components, lubrication, cleaning, and adjusting as required for proper door and door hardware operation. Provide parts and supplies that are the same as those used in the manufacture and installation of original products.

PART 2 - PRODUCTS

2.1 SCHEDULED DOOR HARDWARE

- A. Provide door hardware for each door as scheduled in the architectural Drawings.
 1. Door Hardware Sets: Provide quantity, item, size, finish or color indicated, and named manufacturers' products.
 2. Sequence of Operation: Provide electrified door hardware function, sequence of operation, and interface with other building control systems indicated.

2.2 HINGES

- A. Hinges: BHMA A156.1.
 1. Manufacturers: Basis-of-Design Product is Stanley Commercial Hardware; Div. of The Stanley Works, subject to compliance with requirements, products by the following are also acceptable:
 - a. Bommer Industries, Inc.
 - b. Hager Companies.
 - c. McKinney Products Company; an ASSA ABLOY Group company.

2.3 MECHANICAL LOCKS AND LATCHES

- A. Strikes: Provide manufacturer's standard strike for each lock bolt or latchbolt complying with requirements indicated for applicable lock or latch and with strike box and curved lip extended to protect frame; finished to match lock or latch.
 1. Flat-Lip Strikes: For locks with three-piece antifriction latchbolts, as

SECTION 087100 - DOOR HARDWARE

- recommended by manufacturer.
- 2. Extra-Long-Lip Strikes: For locks used on aluminum frames and frames with applied wood casing trim.
- 3. Aluminum-Frame Strike Box: Manufacturer's special strike box fabricated for aluminum framing.
- B. Bored Locks: BHMA A156.2; Grade 1; Series 4000.
 - 1. Manufacturer: BEST Lock Division of Stanley Security Solutions, Inc.
- C. Mortise Locks: BHMA 156.13; Grade1; Series 1000
 - 1. Manufacturer: BEST Lock Division of Stanley Security Solutions, Inc.

2.4 ELECTRIC STRIKES

- A. Electric Strikes: BHMA A156.31; Grade 1; with faceplate to suit lock and frame.
 - 1. Products: Subject to compliance with requirements, provide the following or equal:
 - a. HES 1006 model.
 - 2. Finish: 630, Satin Stainless Steel

2.5 LOCK CYLINDERS

- A. Lock Cylinders: Removable core cylinders.
 - 1. Manufacturer: Best Access Systems; Div. of Stanley Security Solutions, Inc.
- B. Construction Cores: Provide construction cores that are replaceable by permanent cores.

2.6 KEYING

- A. Keying System: Factory registered, complying with guidelines in BHMA A156.28, Appendix A. Incorporate decisions made in keying conference to the Existing BEST System. Permanent Keying System shall be determined by the Owner and hardware supplier.
 - 1. Grand Master Key System: Change keys, a master key, and a grand master key operate cylinders.
 - a. Master key or grand master key locks to Owner's existing CORMAX system, BEST.
- B. Keys: Nickel silver
 - 1. Stamping: Permanently inscribe each key with a visual key control number and include the following notation:
 - a. Notation: "DO NOT DUPLICATE."
 - 2. Quantity: In addition to one extra key blank for each lock, provide the following:
 - a. Cylinder Change Keys: Three.
 - b. Master Keys: Five.
 - c. Grand Master Keys: Five

2.7 SURFACE CLOSERS

- A. Surface Closers: BHMA A156.4 Grade 1; rack-and-pinion hydraulic type with adjustable sweep and latch speeds controlled by key-operated valves and forged-steel main arm. Comply with manufacturer's written recommendations for size of door closers depending on size of door, exposure to weather, and anticipated frequency of use. Provide factory-sized closers, adjustable to meet field conditions and requirements for opening force.
 - 1. Manufacturers: Basis-of-Design Product is Stanley Commercial Hardware,

SECTION 087100 - DOOR HARDWARE

Division of Stanley Works, subject to compliance with requirements, products by the following are also acceptable:

- a. Sargent Manufacturing, an Assa Abloy Group Company
- b. LCN Closers, Division of Allegion Corp.

2.8 AUTOMATIC OPERATORS

- A. Automatic Operators: BHMA A156.19, Low Energy Operators. Provide Model as specified in hardware groups. Automatic Operators to be installed by Factory Certified Installer.
 1. Manufacturers: Basis-of-Design Product is Stanley Access Technologies., subject to compliance with requirements, products by the following are also acceptable:
 - a. RecordUSA

2.9 MECHANICAL STOPS AND HOLDERS

- A. Wall and Floor Mounted Stops: BHMA A156.16;
 1. Manufacturers: Basis-of-Design Product is Rockwood Manufacturing Company, subject to compliance with requirements, products by the following are also acceptable:
 - a. Architectural Builders Hardware Mfg., Inc.
 - b. Trimco Manufacturing

2.10 OVERHEAD STOPS AND HOLDERS

- A. Overhead Stops and Holders: BHMA A156.8.
 1. Manufacturers: Basis-of-Design Product is Architectural Builders Hardware Mfg., Inc, subject to compliance with requirements, products by the following are also acceptable:
 - a. Glynn-Johnson; an Allegion company

2.11 ELECTROMAGNETIC LOCKS

- B. Electromagnetic Locks: BHMA A156.23; electrically powered; with electromagnet attached to frame and armature plate attached to door; full-exterior or full-interior type, as required by application indicated.
 1. Manufacturers: Subject to compliance with requirements, provide products by one of the following:
 - a. ASSA ABLOY Electronic Security Hardware; ASSA ABLOY.
 - b. Allegion plc.
 - c. Hager Companies.
 - d. dormakaba USA Inc.

2.12 DOOR GASKETING

- A. Door Gasketing: BHMA A156.22; air leakage not to exceed 0.50 cfm per foot of crack

SECTION 087100 - DOOR HARDWARE

length for gasketing other than for smoke control, as tested according to ASTM E 283; with resilient or flexible seal strips that are easily replaceable and readily available from stocks maintained by manufacturer.

1. Manufacturers: Basis-of-Design Product is National Guard Products, subject to compliance with requirements, products by the following are also accept:
 - a. Pemko Manufacturing

2.13 THRESHOLDS

- A. Thresholds: BHMA A156.21; fabricated to full width of opening indicated.
 1. Manufacturers: Basis-of-Design Product is National Guard Products, subject to compliance with requirements, products by the following are also acceptable:
 - a. Pemko Manufacturing.

2.14 METAL PROTECTIVE TRIM UNITS

- A. Metal Protective Trim Units: BHMA A156.6; fabricated from 0.050-inch thick stainless steel; with manufacturer's standard machine or self-tapping screw fasteners.
 1. Manufacturers: Basis-of-Design Product is Rockwood Manufacturing Co., subject to compliance with requirements, products by the following are also acceptable:
 - a. Tice Industries
 2. Size: Fabricate protection plates (kick, armor, or mop) not more than 2" less than door width (LDW) on stop side of single doors and 1" LDW on stop side of pairs of doors, and not more than 1" less than door width on pull side. Coordinate and provide proper width and height as required where conflicting hardware dictates.
 3. Edges: Bevel 4 edges
 4. Heights:
 - a. All new doors within suite to receive 12" metal kickplate on inswing face of door U.O.N.
 - b. All new doors within suite to receive 4" metal mop plate on outswing face of door

2.21 FABRICATION

- C. Manufacturer's Nameplate: Do not provide products that have manufacturer's name or trade name displayed in a visible location except in conjunction with required fire-rated labels and as otherwise approved by Architect.
 1. Manufacturer's identification is permitted on rim of lock cylinders only.
- D. Base Metals: Produce door hardware units of base metal indicated, fabricated by forming method indicated, using manufacturer's standard metal alloy, composition, temper, and hardness. Furnish metals of a quality equal to or greater than that of specified door hardware units and BHMA A156.18.
- E. Fasteners: Provide door hardware manufactured to comply with published templates prepared for machine, wood, and sheet metal screws. Provide screws that comply with commercially recognized industry standards for application intended, except aluminum fasteners are not permitted. Provide Phillips flat-head screws with finished heads to match surface of door hardware, unless otherwise indicated.

SECTION 087100 - DOOR HARDWARE

1. Concealed Fasteners: For door hardware units that are exposed when door is closed, except for units already specified with concealed fasteners. Do not use through bolts for installation where bolt head or nut on opposite face is exposed unless it is the only means of securely attaching the door hardware. Where through bolts are used on hollow door and frame construction, provide sleeves for each through bolt.
2. Fire-Rated Applications:
 - a. Wood or Machine Screws: For the following:
 - 1) Hinges mortised to doors or frames.
 - 2) Strike plates to frames.
 - 3) Closers to doors and frames.
 - b. Steel Through Bolts: For the following unless door blocking is provided:
 - 1) Surface hinges to doors.
 - 2) Closers to doors and frames.
 - 3) Surface-mounted exit devices.
3. Spacers or Sex Bolts: For through bolting of hollow-metal doors.
4. Gasketing Fasteners: Provide noncorrosive fasteners for exterior applications and elsewhere as indicated.

2.22 FINISHES

- F. Provide finishes complying with BHMA A156.18 as indicated in door hardware schedule.
- G. Protect mechanical finishes on exposed surfaces from damage by applying a strippable, temporary protective covering before shipping.
- H. Appearance of Finished Work: Variations in appearance of abutting or adjacent pieces are acceptable if they are within one-half of the range of approved Samples. Noticeable variations in the same piece are not acceptable. Variations in appearance of other components are acceptable if they are within the range of approved Samples and are assembled or installed to minimize contrast.

PART 3 - EXECUTION

3.1 EXAMINATION

- A. Examine doors and frames, with Installer present, for compliance with requirements for installation tolerances, labeled fire-rated door assembly construction, wall and floor construction, and other conditions affecting performance.
- B. Examine roughing-in for electrical power systems to verify actual locations of wiring connections before electrified door hardware installation.
- C. Proceed with installation only after unsatisfactory conditions have been corrected.

3.2 PREPARATION

- A. Steel Doors and Frames: For surface applied door hardware, drill and tap doors and frames according to ANSI/SDI A250.6.

SECTION 087100 - DOOR HARDWARE

- B. Wood Doors: Comply with DHI WDHS.5 "Recommended Hardware Reinforcement Locations for Mineral Core Wood Flush Doors."

3.3 INSTALLATION

- A. Mounting Heights: Mount door hardware units at heights to comply with the following unless otherwise indicated or required to comply with governing regulations.
 - 1. Standard Steel Doors and Frames: ANSI/SDI A250.8.
 - 2. Custom Steel Doors and Frames: HMMA 831.
 - 3. Wood Doors: DHI WDHS.3, "Recommended Locations for Architectural Hardware for Wood Flush Doors."
- B. Install each door hardware item to comply with manufacturer's written instructions. Where cutting and fitting are required to install door hardware onto or into surfaces that are later to be painted or finished in another way, coordinate removal, storage, and reinstallation of surface protective trim units with finishing. Do not install surface-mounted items until finishes have been completed on substrates involved.
 - 1. Set units level, plumb, and true to line and location. Adjust and reinforce attachment substrates as necessary for proper installation and operation.
 - 2. Drill and countersink units that are not factory prepared for anchorage fasteners. Space fasteners and anchors according to industry standards.
- C. Hinges: Install types and in quantities indicated in door hardware schedule but not fewer than the number recommended by manufacturer for application indicated or one hinge for every 30 inches of door height, whichever is more stringent, unless other equivalent means of support for door, such as spring hinges or pivots, are provided.
- D. Intermediate Offset Pivots: Where offset pivots are indicated, provide intermediate offset pivots in quantities indicated in door hardware schedule but not fewer than one intermediate offset pivot per door and one additional intermediate offset pivot for every 30 inches of door height greater than 90 inches.
- E. Lock Cylinders: Install construction cores to secure building and areas during construction period.
 - 1. Furnish permanent cores to Owner for installation.
- F. Boxed Power Supplies: Locate power supplies as indicated or, if not indicated, above accessible ceilings. Verify location with Architect.
 - 1. Configuration: Provide least number of power supplies required to adequately serve doors with electrified door hardware.
- G. Stops: Provide floor stops for doors unless wall or other type stops are indicated in door hardware schedule. Do not mount floor stops where they will impede traffic.
- H. Perimeter Gasketing: Apply to head and jamb, forming seal between door and frame.
- I. Meeting Stile Gasketing: Fasten to meeting stiles, forming seal when doors are closed.
- J. Door Bottoms: Apply to bottom of door, forming seal with threshold when door is closed.

SECTION 087100 - DOOR HARDWARE

3.4 FIELD QUALITY CONTROL

- A. The manufacturer's representative for the locking and closing devices must inspect and approve, in writing, the installation of their products. Hardware installed incorrectly must be reported to architect prior to the architect'

3.5 ADJUSTING

- A. Initial Adjustment: Adjust and check each operating item of door hardware and each door to ensure proper operation or function of every unit. Replace units that cannot be adjusted to operate as intended. Adjust door control devices to compensate for final operation of heating and ventilating equipment and to comply with referenced accessibility requirements.
 - 1. Electric Strikes: Adjust horizontal and vertical alignment of keeper to properly engage lock bolt.
 - 2. Door Closers: Adjust sweep period to comply with accessibility requirements and requirements of authorities having jurisdiction.
- B. Final Adjustment: The manufacturer's representative for the door closing devices must inspect and adjust closers at the competition of the project. The HVAC system must be completed and balanced prior to the closer adjustment.

3.6 CLEANING AND PROTECTION

- A. Clean adjacent surfaces soiled by door hardware installation.
- B. Clean operating items as necessary to restore proper function and finish.
- C. Provide final protection and maintain conditions that ensure that door hardware is without damage or deterioration at time of Substantial Completion.

3.7 DOOR HARDWARE SCHEDULE

- A. See Drawings for door hardware schedule

SECTION 087100 - DOOR HARDWARE

END OF SECTION

SECTION 089119 - FIXED LOUVERS

SECTION 089119 - FIXED LOUVERS

PART 1 - GENERAL

1.1 RELATED DOCUMENTS

- A. Drawings and general provisions of the Contract, including General and Supplementary Conditions and Division 01 Specification Sections, apply to this Section.

1.2 SUMMARY

- A. Section Includes:
 - 1. Fixed formed-metal louvers.

1.3 DEFINITIONS

- A. Louver Terminology: Definitions of terms for metal louvers contained in AMCA 501 apply to this Section unless otherwise defined in this Section or in referenced standards.
- B. Horizontal Louver: Louver with horizontal blades (i.e., the axis of the blades are horizontal).

1.4 ACTION SUBMITTALS

- A. Product Data: For each type of product.
 - 1. For louvers specified to bear AMCA seal, include printed catalog pages showing specified models with appropriate AMCA Certified Ratings Seals.
- B. Shop Drawings: For louvers and accessories. Include plans, elevations, sections, details, and attachments to other work. Show frame profiles and blade profiles, angles, and spacing.
 - 1. Show mullion profiles and locations.
- C. Samples: For each type of metal finish required.
- D. Delegated-Design Submittal: For louvers indicated to comply with structural and seismic performance requirements and design criteria, including analysis data signed and sealed by the qualified professional engineer responsible for their preparation.

1.5 INFORMATIONAL SUBMITTALS

- A. Product Test Reports: Based on evaluation of comprehensive tests performed according to AMCA 500-L by a qualified testing agency or by manufacturer and witnessed by a qualified

SECTION 089119 - FIXED LOUVERS

testing agency, for each type of louver and showing compliance with performance requirements specified.

1.6 QUALITY ASSURANCE

- A. Welding Qualifications: Qualify procedures and personnel according to the following:
 - 1. AWS D1.2/D1.2M.
 - 2. AWS D1.3/D1.3M.
 - 3. AWS D1.6/D1.6M.

1.7 FIELD CONDITIONS

- A. Field Measurements: Verify actual dimensions of openings by field measurements before fabrication.

1.8 WARRANTY

- A. Special Finish Warranty: Manufacturer agrees to repair or replace components on which finishes fail in materials or workmanship within specified warranty period.
 - 1. Deterioration includes, but is not limited to, the following:
 - a. Color fading more than 5 Hunter units when tested according to ASTM D 2244.
 - b. Chalking in excess of a No. 8 rating when tested according to ASTM D 4214.
 - c. Cracking, checking, peeling, or failure of paint to adhere to bare metal.
 - 2. Warranty Period: 5 years from date of Substantial Completion.

PART 2 - PRODUCTS

2.1 MANUFACTURERS

- A. Source Limitations: Obtain fixed louvers from single source from a single manufacturer where indicated to be of same type, design, or factory-applied color finish.

2.2 PERFORMANCE REQUIREMENTS

- A. Delegated Design: Design louvers, including comprehensive engineering analysis by a qualified professional engineer, using structural and seismic performance requirements and design criteria indicated.
- B. Structural Performance: Louvers shall withstand the effects of gravity loads and the following loads and stresses within limits and under conditions indicated without permanent deformation of louver components, noise or metal fatigue caused by louver-blade rattle or flutter, or

SECTION 089119 - FIXED LOUVERS

permanent damage to fasteners and anchors. Wind pressures shall be considered to act normal to the face of the building.

1. Wind Loads: Determine loads based on pressures as indicated on Drawings.
 2. Wind Loads: Determine loads based on a uniform pressure of 20 lbf/sq. ft., acting inward or outward.
- C. Windborne-Debris-Impact Resistance: Louvers located within 30 feet of grade shall pass basic protection, when tested according to AMCA 540.
- D. Seismic Performance: As indicated on drawings.
- E. Seismic Performance: Louvers, including attachments to other construction, shall withstand the effects of earthquake motions determined according to ASCE/SEI 7
- F. Louver Performance Ratings: Provide louvers complying with requirements specified, as demonstrated by testing manufacturer's stock units identical to those provided, except for length and width according to AMCA 500-L.
- G. Thermal Movements: Allow for thermal movements from ambient and surface temperature changes.
1. Temperature Change (Range): 120 deg F (67 deg C), ambient; 180 deg F (100 deg C), material surfaces.
- H. SMACNA Standard: Comply with recommendations in SMACNA's "Architectural Sheet Metal Manual" for fabrication, construction details, and installation procedures.

2.3 FIXED FORMED-METAL LOUVERS

1. Basis of Design Product: subject to compliance with requirements, provide Ruskin Horizontal Blade Louver, Model EV811:
2. Louver Depth: 4 inches
3. Blade Profile: Horizontal
4. Frame and Blade Material and Nominal Thickness: Extruded Aluminum Alloy 6063-T6, wall thickness: 0.081 inches.
5. Mullion Type: Fully recessed
6. Louver Performance Ratings:
 - a. Based on testing 48 inch x 48 inch (1,219 mm x 1,219 mm) size unit in accordance with AMCA 500.
 - b. Free Area: 44 percent, nominal.
 - c. Free Area Size: 7.10 square feet (0.66 m²) on 48 inches by 48 inches (1219 mm by 1219 mm) size.screen.
7. AMCA Seal: Mark units with AMCA Certified Ratings Seal.

SECTION 089119 - FIXED LOUVERS

2.4 MATERIALS

- A. ASTM B 221, Extruded Aluminum Alloy 6063-T6
- B. Fasteners: Use types and sizes to suit unit installation conditions.
 - 1. Use Phillips flat-head screws for exposed fasteners unless otherwise indicated.
 - 2. For fastening aluminum, use aluminum or 300 series stainless-steel fasteners.
 - 3. For fastening galvanized steel, use hot-dip-galvanized-steel or 300 series stainless-steel fasteners.
 - 4. For fastening stainless steel, use 300 series stainless-steel fasteners.
 - 5. For color-finished louvers, use fasteners with heads that match color of louvers.
- C. Postinstalled Fasteners for Concrete and Masonry: Torque-controlled expansion anchors, fabricated from stainless-steel components, with allowable load or strength design capacities calculated according to ICC-ES AC193 and ACI 318 greater than or equal to the design load, as determined by testing according to ASTM E 488/E 488M conducted by a qualified testing agency.
- D. Bituminous Paint: Cold-applied asphalt emulsion complying with ASTM D 1187/D 1187M.

2.5 FABRICATION

- A. Factory assemble louvers to minimize field splicing and assembly. Disassemble units as necessary for shipping and handling limitations. Clearly mark units for reassembly and coordinated installation.
- B. Maintain equal louver blade spacing to produce uniform appearance.
- C. Fabricate frames, including integral sills, to fit in openings of sizes indicated, with allowances made for fabrication and installation tolerances, adjoining material tolerances, and perimeter sealant joints.
 - 1. Frame Type: Channel unless otherwise indicated.
- D. Include supports, anchorages, and accessories required for complete assembly.
- E. Provide vertical mullions of type and at spacings indicated, but not more than is recommended by manufacturer, or 72 inches o.c., whichever is less.
 - 1. Fully Recessed Mullions: Where indicated, provide mullions fully recessed behind louver blades. Where length of louver exceeds fabrication and handling limitations, fabricate with close-fitting blade splices designed to permit expansion and contraction.
 - 2. Semirecessed Mullions: Where indicated, provide mullions partly recessed behind louver blades, so louver blades appear continuous. Where length of louver exceeds fabrication and handling limitations, fabricate with interlocking split mullions and close-fitting blade splices designed to permit expansion and contraction.
 - 3. Exposed Mullions: Where indicated, provide units with exposed mullions of same width and depth as louver frame. Where length of louver exceeds fabrication and handling

SECTION 089119 - FIXED LOUVERS

limitations, provide interlocking split mullions designed to permit expansion and contraction.

4. Exterior Corners: Prefabricated corner units with mitered blades with concealed close-fitting splices and with fully recessed mullions at corners.

- F. Join frame members to each other and to fixed louver blades with fillet welds concealed from view] [, threaded fasteners, or both, as standard with louver manufacturer unless otherwise indicated or size of louver assembly makes bolted connections between frame members necessary.

2.6 ALUMINUM FINISHES

- A. Finish louvers after assembly.
- B. Epoxy-based Painted Finish
 1. Color and Gloss: As selected by Architect from manufacturer's full range

PART 3 - EXECUTION

3.1 EXAMINATION

- A. Examine substrates and openings, with Installer present, for compliance with requirements for installation tolerances and other conditions affecting performance of the Work.
- B. Proceed with installation only after unsatisfactory conditions have been corrected.

3.2 PREPARATION

- A. Coordinate setting drawings, diagrams, templates, instructions, and directions for installation of anchorages that are to be embedded in concrete or masonry construction. Coordinate delivery of such items to Project site.

3.3 INSTALLATION

- A. Locate and place louvers level, plumb, and at indicated alignment with adjacent work.
- B. Use concealed anchorages where possible. Provide brass or lead washers fitted to screws where required to protect metal surfaces and to make a weathertight connection.
- C. Form closely fitted joints with exposed connections accurately located and secured.
- D. Provide perimeter reveals and openings of uniform width for sealants and joint fillers, as indicated.

SECTION 089119 - FIXED LOUVERS

- E. Protect unpainted galvanized- and nonferrous-metal surfaces that are in contact with concrete, masonry, or dissimilar metals from corrosion and galvanic action by applying a heavy coating of bituminous paint or by separating surfaces with waterproof gaskets or nonmetallic flashing.
- F. Install concealed gaskets, flashings, joint fillers, and insulation as louver installation progresses, where weathertight louver joints are required. Comply with Section 079200 "Joint Sealants" for sealants applied during louver installation.

3.4 ADJUSTING AND CLEANING

- A. Clean exposed louver surfaces that are not protected by temporary covering, to remove fingerprints and soil during construction period. Do not let soil accumulate during construction period.
- B. Before final inspection, clean exposed surfaces with water and a mild soap or detergent not harmful to finishes. Thoroughly rinse surfaces and dry.
- C. Restore louvers damaged during installation and construction, so no evidence remains of corrective work. If results of restoration are unsuccessful, as determined by Architect, remove damaged units and replace with new units.
 - 1. Touch up minor abrasions in finishes with air-dried coating that matches color and gloss of, and is compatible with, factory-applied finish coating.

END OF SECTION 089119

SECTION 092216 - NON-STRUCTURAL METAL FRAMING

PART 1 - GENERAL

1.1 RELATED DOCUMENTS

- A. Drawings and general provisions of the Contract, including General and Supplementary Conditions and Division 01 Specification Sections, apply to this Section.

1.2 SUMMARY

- A. Section Includes:
 - 1. Non-load-bearing steel framing systems for interior partitions.

1.3 SUBMITTALS

- A. Product Data: For each type of product.

PART 2 - PRODUCTS

2.1 PERFORMANCE REQUIREMENTS

- A. Fire-Test-Response Characteristics: For fire-resistance-rated assemblies that incorporate non-load-bearing steel framing, provide materials and construction identical to those tested in assembly indicated, according to ASTM E 119 by an independent testing agency.
- B. STC-Rated Assemblies: For STC-rated assemblies, provide materials and construction identical to those tested in assembly indicated, according to ASTM E 90 and classified according to ASTM E 413 by an independent testing agency.
- C. Horizontal Deflection: For wall assemblies, limited to 1/240 of the wall height based on horizontal loading of 5 lbf/sq. ft..
- D. Must meet category 5 earthquake conditions

2.2 FRAMING SYSTEMS

- A. Framing Members, General: Comply with ASTM C 754 for conditions indicated.
 - 1. Steel Sheet Components: Comply with ASTM C 645 requirements for metal unless otherwise indicated.
 - 2. Protective Coating: ASTM A 653/A 653M, G40, hot-dip galvanized unless otherwise indicated.
- B. Studs and Runners: ASTM C 645.
 - 1. Steel Studs and Runners:
 - a. Minimum Base-Metal Thickness: galvanized 20 gauge steel (0.0359)
 - b. Depth: As indicated on Drawings.
- C. Slip-Type Head Joints: Where indicated, provide one of the following:
 - 1. Single Long-Leg Runner System: ASTM C 645 top runner with 2-inch-deep flanges in thickness not less than indicated for studs, installed with studs friction fit into top runner

SECTION 092216 - NON-STRUCTURAL METAL FRAMING

and with continuous bridging located within 12 inches of the top of studs to provide lateral bracing.

2. Double-Runner System: ASTM C 645 top runners, inside runner with 2-inch-deep flanges in thickness not less than indicated for studs and fastened to studs, and outer runner sized to friction fit inside runner.
3. Deflection Track: Steel sheet top runner manufactured to prevent cracking of finishes applied to interior partition framing resulting from deflection of structure above; in thickness not less than indicated for studs and in width to accommodate depth of studs.

D. Firestop Tracks: Top runner manufactured to allow partition heads to expand and contract with movement of structure while maintaining continuity of fire-resistance-rated assembly indicated; in thickness not less than indicated for studs and in width to accommodate depth of studs.

E. Flat Strap and Backing Plate: Steel sheet for blocking and bracing in length and width indicated.
1. Minimum Base-Metal Thickness: 0.0179 inch.

F. Cold-Rolled Channel Bridging: Steel, 0.0538-inch minimum base-metal thickness, with minimum 1/2-inch-wide flanges.

1. Depth: 1-1/2 inches.
2. Clip Angle: Not less than 1-1/2 by 1-1/2 inches, 0.068-inch-thick, galvanized steel.

2.3 SUSPENSION SYSTEMS

A. Tie Wire: ASTM A 641/A 641M, Class 1 zinc coating, soft temper, 0.062-inch-diameter wire, or double strand of 0.048-inch-diameter wire.

B. Hanger Attachments to Concrete:

1. Expansion Anchors: Fabricated from corrosion-resistant materials, with allowable load or strength design capacities calculated according to ICC-ES AC193 and ACI 318 greater than or equal to the design load, as determined by testing per ASTM E 488/E 488M conducted by a qualified testing agency.
2. Power-Actuated Anchors: Fastener system of type suitable for application indicated, fabricated from corrosion-resistant materials, with allowable load capacities calculated according to ICC-ES AC70, greater than or equal to the design load, as determined by testing per ASTM E 1190 conducted by a qualified testing agency.

C. Wire Hangers: ASTM A 641/A 641M, Class 1 zinc coating, soft temper, 0.16 inch in diameter.

D. Flat Hangers: Steel sheet, 1 by 3/16 inch by length indicated.

E. Carrying Channels: Cold-rolled, commercial-steel sheet with a base-metal thickness of 0.0538 inch and minimum 1/2-inch-wide flanges.

1. Depth: 2-1/2 inches.

F. Grid Suspension System for Gypsum Board Ceilings: ASTM C 645, direct-hung system composed of main beams and cross-furring members that interlock.

2.4 AUXILIARY MATERIALS

A. General: Provide auxiliary materials that comply with referenced installation standards.

1. Fasteners for Metal Framing: Of type, material, size, corrosion resistance, holding power, and other properties required to fasten steel members to substrates.

SECTION 092216 - NON-STRUCTURAL METAL FRAMING

- B. Isolation Strip at Exterior Walls: Provide the following:
 - 1. Foam Gasket: Adhesive-backed, closed-cell vinyl foam strips that allow fastener penetration without foam displacement, 1/8 inch thick, in width to suit steel stud size.

PART 3 - EXECUTION

3.1 INSTALLATION, GENERAL

- A. Installation Standard: ASTM C 754.
 - 1. Gypsum Board Assemblies: Also comply with requirements in ASTM C 840 that apply to framing installation.
- B. Install framing and accessories plumb, square, and true to line, with connections securely fastened.
- C. Install supplementary framing, and blocking to support fixtures, equipment services, heavy trim, grab bars, toilet accessories, furnishings, or similar construction.
- D. Install bracing at terminations in assemblies.
- E. Do not bridge building control and expansion joints with non-load-bearing steel framing members. Frame both sides of joints independently.

3.2 INSTALLING FRAMED ASSEMBLIES

- A. Install framing system components according to spacings indicated, but not greater than spacings required by referenced installation standards for assembly types.
 - 1. Single-Layer Application: 16 inches o.c. unless otherwise indicated.
 - 2. Multilayer Application: 16 inches o.c. unless otherwise indicated.
 - 3. Tile Backing Panels: 16 inches o.c. unless otherwise indicated.
- B. Where studs are installed directly against exterior masonry walls or dissimilar metals at exterior walls, install isolation strip between studs and exterior wall.
- C. Install studs so flanges within framing system point in same direction.
- D. Install tracks (runners) at floors and overhead supports. Extend framing full height to structural supports or substrates above suspended ceilings except where partitions are indicated to terminate at suspended ceilings. Continue framing around ducts that penetrate partitions above ceiling.
 - 1. Slip-Type Head Joints: Where framing extends to overhead structural supports, install to produce joints at tops of framing systems that prevent axial loading of finished assemblies.
 - 2. Door Openings: Screw vertical studs at jambs to jamb anchor clips on door frames; install runner track section (for cripple studs) at head and secure to jamb studs.
 - a. Install two studs at each jamb unless otherwise indicated.
 - b. Install cripple studs at head adjacent to each jamb stud, with a minimum 1/2-inch clearance from jamb stud to allow for installation of control joint in finished assembly.
 - c. Extend jamb studs through suspended ceilings and attach to underside of overhead structure.

SECTION 092216 - NON-STRUCTURAL METAL FRAMING

3. Other Framed Openings: Frame openings other than door openings the same as required for door openings unless otherwise indicated. Install framing below sills of openings to match framing required above door heads.
 4. Fire-Resistance-Rated Partitions: Install framing to comply with fire-resistance-rated assembly indicated and support closures and to make partitions continuous from floor to underside of solid structure.
 - a. Firestop Track: Where indicated, install to maintain continuity of fire-resistance-rated assembly indicated.
 5. Sound-Rated Partitions: Install framing to comply with sound-rated assembly indicated.
- E. Installation Tolerance: Install each framing member so fastening surfaces vary not more than 1/8 inch from the plane formed by faces of adjacent framing.

3.3 INSTALLING SUSPENSION SYSTEMS

- A. Install suspension system components according to spacings indicated, but not greater than spacings required by referenced installation standards for assembly types.
1. Hangers: 48 inches o.c.
 2. Carrying Channels (Main Runners): 48 inches o.c.
 3. Furring Channels (Furring Members): 16 inches o.c.
- B. Isolate suspension systems from building structure where they abut or are penetrated by building structure to prevent transfer of loading imposed by structural movement.
- C. Suspend hangers from building structure as follows:
1. Install hangers plumb and free from contact with insulation or other objects within ceiling plenum that are not part of supporting structural or suspension system.
 - a. Splay hangers only where required to miss obstructions and offset resulting horizontal forces by bracing, countersplaying, or other equally effective means.
 2. Where width of ducts and other construction within ceiling plenum produces hanger spacings that interfere with locations of hangers required to support standard suspension system members, install supplemental suspension members and hangers in the form of trapezes or equivalent devices.
 3. Do not attach hangers to steel roof deck.
 4. Do not attach hangers to permanent metal forms. Furnish cast-in-place hanger inserts that extend through forms.
 5. Do not attach hangers to rolled-in hanger tabs of composite steel floor deck.
 6. Do not connect or suspend steel framing from ducts, pipes, or conduit.
- D. Fire-Resistance-Rated Assemblies: Wire tie furring channels to supports.
- E. Seismic Bracing: Sway-brace suspension systems.
- F. Installation Tolerances: Install suspension systems that are level to within 1/8 inch in 12 feet measured lengthwise on each member that will receive finishes and transversely between parallel members that will receive finishes.

END OF SECTION

SECTION 092900 - GYPSUM BOARD

PART 1 - GENERAL

1.1 RELATED DOCUMENTS

- A. Drawings and general provisions of the Contract, including General and Supplementary Conditions and Division 01 Specification Sections, apply to this Section.

1.2 SUMMARY

- A. Section Includes:
 - 1. Interior gypsum board.
- B. Related Requirements:
 - 1. Section 092216 "Non-Structural Metal Framing" for non-structural steel framing and suspension systems that support gypsum board panels.

1.3 SUBMITTALS

- A. Product Data: For each type of product.

1.4 DELIVERY, STORAGE AND HANDLING

- A. Store materials inside under cover and keep them dry and protected against weather, condensation, direct sunlight, construction traffic, and other potential causes of damage. Stack panels flat and supported on risers on a flat platform to prevent sagging.

1.5 FIELD CONDITIONS

- A. Environmental Limitations: Comply with ASTM C 840 requirements or gypsum board manufacturer's written instructions, whichever are more stringent.
- B. Do not install paper-faced gypsum panels until installation areas are enclosed and conditioned.
- C. Do not install panels that are wet, moisture damaged, and mold damaged.
 - 1. Indications that panels are wet or moisture damaged include, but are not limited to, discoloration, sagging, or irregular shape.
 - 2. Indications that panels are mold damaged include, but are not limited to, fuzzy or splotchy surface contamination and discoloration.

PRODUCTS

1.6 PERFORMANCE REQUIREMENTS

- A. Fire-Resistance-Rated Assemblies: For fire-resistance-rated assemblies, provide materials and construction identical to those tested in assembly indicated according to ASTM E 119 by an independent testing agency.

SECTION 092900 - GYPSUM BOARD

- B. STC-Rated Assemblies: For STC-rated assemblies, provide materials and construction identical to those tested in assembly indicated according to ASTM E 90 and classified according to ASTM E 413 by an independent testing agency.

1.7 INTERIOR GYPSUM BOARD

- A. Gypsum Board, Type X: ASTM C 1396/C 1396M.
 - 1. Thickness: 5/8 inch.
 - 2. Long Edges: Tapered.

1.8 TRIM ACCESSORIES

- A. Interior Trim: ASTM C 1047.
 - 1. Material: Galvanized or aluminum-coated steel sheet, rolled zinc, plastic, or paper-faced galvanized-steel sheet.
 - 2. Shapes:
 - a. Cornerbead.
 - b. Bullnose bead.
 - c. LC-Bead: J-shaped; exposed long flange receives joint compound.
 - d. L-Bead: L-shaped; exposed long flange receives joint compound.
 - e. U-Bead: J-shaped; exposed short flange does not receive joint compound.
 - f. Expansion (control) joint.
- B. Aluminum Trim: Extruded accessories of profiles and dimensions indicated.
 - 1. Aluminum: Alloy and temper with not less than the strength and durability properties of ASTM B 221, Alloy 6063-T5.

1.9 JOINT TREATMENT MATERIALS

- A. General: Comply with ASTM C 475/C 475M.
- B. Joint Tape:
 - 1. Interior Gypsum Board: Paper.
- C. Joint Compound for Interior Gypsum Board: For each coat, use formulation that is compatible with other compounds applied on previous or for successive coats.
 - 1. Prefilling: At open joints and damaged surface areas, use setting-type taping compound.
 - 2. Embedding and First Coat: For embedding tape and first coat on joints, fasteners, and trim flanges, use drying-type, all-purpose compound.
 - a. Use setting-type compound for installing paper-faced metal trim accessories.
 - 3. Fill Coat: For second coat, use drying-type, all-purpose compound.
 - 4. Finish Coat: For third coat, use drying-type, all-purpose compound.
 - 5. Skim Coat: For final coat of Level 5 finish, use drying-type, all-purpose compound or high-build interior coating product designed for application by airless sprayer and to be used instead of skim coat to produce Level 5 finish.

1.10 AUXILIARY MATERIALS

- A. General: Provide auxiliary materials that comply with referenced installation standards and manufacturer's written instructions.

SECTION 092900 - GYPSUM BOARD

- B. Steel Drill Screws: ASTM C 1002 unless otherwise indicated.
- C. Sound-Attenuation Blankets: ASTM C 665, Type I (blankets without membrane facing) produced by combining thermosetting resins with mineral fibers manufactured from glass, slag wool, or rock wool.
 - 1. Fire-Resistance-Rated Assemblies: Comply with mineral-fiber requirements of assembly.
- D. Acoustical Sealant: Manufacturer's standard nonsag, paintable, nonstaining latex sealant complying with ASTM C 834. Product effectively reduces airborne sound transmission through perimeter joints and openings in building construction as demonstrated by testing representative assemblies according to ASTM E 90.

PART 2 - EXECUTION

2.1 EXAMINATION

- A. Examine areas and substrates including welded hollow-metal frames and support framing, with Installer present, for compliance with requirements and other conditions affecting performance of the Work.
- B. Examine panels before installation. Reject panels that are wet, moisture damaged, and mold damaged.
- C. Proceed with installation only after unsatisfactory conditions have been corrected.

2.2 APPLYING AND FINISHING PANELS, GENERAL

- A. Comply with ASTM C 840.
- B. Install ceiling panels across framing to minimize the number of abutting end joints and to avoid abutting end joints in central area of each ceiling. Stagger abutting end joints of adjacent panels not less than one framing member.
- C. Install panels with face side out. Butt panels together for a light contact at edges and ends with not more than 1/16 inch of open space between panels. Do not force into place.
- D. Locate edge and end joints over supports, except in ceiling applications where intermediate supports or gypsum board back-blocking is provided behind end joints. Do not place tapered edges against cut edges or ends. Stagger vertical joints on opposite sides of partitions. Do not make joints other than control joints at corners of framed openings.
- E. Form control and expansion joints with space between edges of adjoining gypsum panels.
- F. Cover both faces of support framing with gypsum panels in concealed spaces (above ceilings, etc.), except in chases braced internally.
 - 1. Unless concealed application is indicated or required for sound, fire, air, or smoke ratings, coverage may be accomplished with scraps of not less than 8 sq. ft. in area.
 - 2. Fit gypsum panels around ducts, pipes, and conduits.

SECTION 092900 - GYPSUM BOARD

3. Where partitions intersect structural members projecting below underside of floor/roof slabs and decks, cut gypsum panels to fit profile formed by structural members; allow 1/4- to 3/8-inch-wide joints to install sealant.
- G. Isolate perimeter of gypsum board applied to non-load-bearing partitions at structural abutments. Provide 1/4- to 1/2-inch-wide spaces at these locations and trim edges with edge trim where edges of panels are exposed. Seal joints between edges and abutting structural surfaces with acoustical sealant.
- H. Attachment to Steel Framing: Attach panels so leading edge or end of each panel is attached to open (unsupported) edges of stud flanges first.
- I. STC-Rated Assemblies: Seal construction at perimeters, behind control joints, and at openings and penetrations with a continuous bead of acoustical sealant. Install acoustical sealant at both faces of partitions at perimeters and through penetrations. Comply with ASTM C 919 and with manufacturer's written instructions for locating edge trim and closing off sound-flanking paths around or through assemblies, including sealing partitions above acoustical ceilings.
- J. Install sound attenuation blankets before installing gypsum panels unless blankets are readily installed after panels have been installed on one side.

2.3 APPLYING INTERIOR GYPSUM BOARD

- A. Single-Layer Application:
 1. On ceilings, apply gypsum panels before wall/partition board application to greatest extent possible and at right angles to framing unless otherwise indicated.
 2. On partitions/walls, apply gypsum panels vertically (parallel to framing) unless otherwise indicated or required by fire-resistance-rated assembly, and minimize end joints.
 - a. Stagger abutting end joints not less than one framing member in alternate courses of panels.
 - b. At stairwells and other high walls, install panels horizontally unless otherwise indicated or required by fire-resistance-rated assembly.
 3. Fastening Methods: Apply gypsum panels to supports with steel drill screws.
- B. Multilayer Application:
 1. On ceilings, apply gypsum board indicated for base layers before applying face layers on walls/partitions; apply face layers in same sequence. Apply base layers at right angles to framing members and offset face-layer joints one framing member, 16 inches minimum, from parallel base-layer joints, unless otherwise indicated or required by fire-resistance-rated assembly.
 2. On partitions/walls, apply gypsum board indicated for base layers and face layers vertically (parallel to framing) with joints of base layers located over stud or furring member and face-layer joints offset at least one stud or furring member with base-layer joints unless otherwise indicated or required by fire-resistance-rated assembly. Stagger joints on opposite sides of partitions.
 3. Fastening Methods: Fasten base layers and face layers separately to supports with screws.

SECTION 092900 - GYPSUM BOARD

2.4 INSTALLING TRIM ACCESSORIES

- A. General: For trim with back flanges intended for fasteners, attach to framing with same fasteners used for panels. Otherwise, attach trim according to manufacturer's written instructions.
- B. Control Joints: Install control joints according to ASTM C 840 and in specific locations approved by Architect for visual effect.
- C. Interior Trim: Install in the following locations:
 - 1. Cornerbead: Use at outside corners unless otherwise indicated.
 - 2. LC-Bead: Use at exposed panel edges.
 - 3. L-Bead: Use where indicated.
 - 4. U-Bead: Use where indicated.
- D. Aluminum Trim: Install in locations indicated on Drawings.

2.5 FINISHING GYPSUM BOARD

- A. General: Treat gypsum board joints, interior angles, edge trim, control joints, penetrations, fastener heads, surface defects, and elsewhere as required to prepare gypsum board surfaces for decoration. Promptly remove residual joint compound from adjacent surfaces.
- B. Prefill open joints and damaged surface areas.
- C. Apply joint tape over gypsum board joints, except for trim products specifically indicated as not intended to receive tape.
- D. Gypsum Board Finish Levels: Finish panels to levels indicated below and according to ASTM C 840:
 - 1. Level 1: Ceiling plenum areas, concealed areas, and where indicated.
 - 2. Level 4: Surfaces scheduled for flat paints and panel surfaces that will be exposed to view, unless otherwise indicated.
 - a. Primer and its application to surfaces are specified in Section 099123 "Interior Painting."
 - 3. Level 5: Surfaces scheduled for gloss and semi-gloss coatings.
 - a. Primer and its application to surfaces are specified in Section 099123 "Interior Painting."

2.6 PROTECTION

- A. Protect adjacent surfaces from drywall compound and promptly remove from floors and other non-drywall surfaces. Repair surfaces stained, marred, or otherwise damaged during drywall application.
- B. Protect installed products from damage from weather, condensation, direct sunlight, construction, and other causes during remainder of the construction period.
- C. Remove and replace panels that are wet, moisture damaged, and mold damaged.

SECTION 092900 - GYPSUM BOARD

1. Indications that panels are wet or moisture damaged include, but are not limited to, discoloration, sagging, or irregular shape.
2. Indications that panels are mold damaged include, but are not limited to, fuzzy or splotchy surface contamination and discoloration.

END OF SECTION

SECTION 095113 - ACOUSTICAL PANEL CEILING

PART 1 - GENERAL

1.1 RELATED DOCUMENTS

- A. Drawings and general provisions of the Contract, including General and Supplementary Conditions and Division 01 Specification Sections, apply to this Section.

1.2 SUMMARY

- A. Section includes acoustical panels and exposed suspension systems for interior ceilings.
- B. Related Requirements: Section 079200 "Joint Sealants" for acoustic sealant joints.
- C. Products furnished, but not installed under this Section, include anchors, clips, and other ceiling attachment devices to be cast in concrete.

1.3 SUBMITTALS

- A. Product Data: For each type of product.
- B. Maintenance Data: For finishes to include in maintenance manuals.

1.4 MAINTENANCE MATERIAL SUBMITTALS

- A. Furnish extra materials that match products installed and that are packaged with protective covering for storage and identified with labels describing contents.
 - 1. Acoustical Ceiling Units: Full-size panels equal to 2 percent of quantity installed.

1.5 DELIVERY, STORAGE, AND HANDLING

- A. Deliver acoustical panels, suspension-system components, and accessories to Project site and store them in a fully enclosed, conditioned space where they will be protected against damage from moisture, humidity, temperature extremes, direct sunlight, surface contamination, and other causes.
- B. Before installing acoustical panels, permit them to reach room temperature and a stabilized moisture content.

1.6 FIELD CONDITIONS

- A. Environmental Limitations: Do not install acoustical panel ceilings until spaces are enclosed and weathertight, wet-work in spaces is complete and dry, work above ceilings is complete, and ambient temperature and humidity conditions are maintained at the levels indicated for Project when occupied for its intended use.

SECTION 095113 - ACOUSTICAL PANEL CEILING

PART 2 - PRODUCTS

2.1 MANUFACTURERS

- A. Source Limitations: Obtain each type of acoustical ceiling panel and its supporting suspension system from single source from single manufacturer.

2.2 PERFORMANCE REQUIREMENTS

- A. Seismic Performance: Suspended ceilings shall withstand the effects of earthquake motions determined according to ASCE/SEI 7.
- B. Surface-Burning Characteristics: Comply with ASTM E 84; testing by a qualified testing agency. Identify products with appropriate markings of applicable testing agency.
 - 1. Flame-Spread Index: Class A according to ASTM E 1264.
 - 2. Smoke-Developed Index: 50 or less.
- C. Fire-Resistance Ratings: Comply with ASTM E 119; testing by a qualified testing agency. Identify products with appropriate markings of applicable testing agency.
 - 1. Indicate design designations from UL or from the listings of another qualified testing agency.

2.3 ACOUSTICAL PANELS

- A. Manufacturers: Subject to compliance with requirements, provide products by the following:
 - 1. Armstrong
- B. Acoustic Panel Type ACP-1
 - 1. Basis of Design Product: Subject to compliance with requirements, provide Optima #3152 manufactured by Armstrong World Industries
 - 2. Classification: Type XII, Form 2, Pattern E
 - 3. Color: White
 - 4. Light Reflectance (LR): Not less than 0.88.
 - 5. Noise Reduction Coefficient (NRC): Not less than 0.95.
 - 6. Edge/Joint Detail: Beveled Tegular
 - 7. Thickness: 15/16 inch.
 - 8. Modular Size: 24 by 24 inches.

2.4 METAL SUSPENSION SYSTEM

- A. Basis-of-Design Product: Subject to compliance with requirements, provide Prelude XL by Armstrong World Industries, Inc. For MRI ceiling, provide Prelude Plus XL Aluminum 15/16" Exposed Tee. MRI metal suspension ceiling and all ceiling accessories must be comprised of nonferrous metal.
- B. Wide-Face, Capped, Double-Web, Steel Suspension System: Main and cross runners roll formed from cold-rolled steel sheet; pre-painted, electrolytically zinc coated, or hot-dip

SECTION 095113 - ACOUSTICAL PANEL CEILING

galvanized according to ASTM A 653/A 653M, not less than G30 (Z90) coating designation; with prefinished 15/16-inch -wide metal caps on flanges.

1. Structural Classification: Heavy-duty system.
2. End Condition of Cross Runners: Override (stepped) or butt-edge type.
3. Face Design: Flat, flush.
4. Cap Material: Steel cold-rolled sheet.
5. Cap Finish: Painted white.

2.5 ACCESSORIES

- A. Attachment Devices: Size for five times the design load indicated in ASTM C 635/C 635M, Table 1, "Direct Hung," unless otherwise indicated. Comply with seismic design requirements.
1. Anchors in Concrete: Anchors of type and material indicated below, with holes or loops for attaching hangers of type indicated and with capability to sustain, without failure, a load equal to five times that imposed by ceiling construction, as determined by testing according to ASTM E 488/E 488M or ASTM E 1512 as applicable, conducted by a qualified testing and inspecting agency.
 - a. Corrosion Protection: Carbon-steel components zinc plated according to ASTM B 633, Class SC 1 (mild) service condition.
- B. Wire Hangers, Braces, and Ties: Provide wires as follows:
1. Zinc-Coated, Carbon-Steel Wire: ASTM A 641/A 641M, Class 1 zinc coating, soft temper.
 2. Size: Wire diameter sufficient for its stress at three times hanger design load (ASTM C 635/C 635M, Table 1, "Direct Hung") will be less than yield stress of wire, but not less than 0.106-inch- diameter wire.
- C. Hanger Rods and Flat Hangers: Mild steel, zinc coated or protected with rust-inhibitive paint.
- D. Angle Hangers: Angles with legs not less than 7/8 inch wide; formed with 0.04-inch-thick, galvanized-steel sheet complying with ASTM A 653/A 653M, G90 coating designation; with bolted connections and 5/16-inch-diameter bolts.
- E. Seismic Struts: Manufacturer's standard compression struts designed to accommodate seismic forces.
- F. Seismic Perimeter Retention System:
1. Seismic Wall Molding: 2 inch molding.
 2. Seismic Perimeter Clips: Manufacturer's standard clips designed to accommodate seismic forces.

2.6 METAL EDGE MOLDINGS AND TRIM

- A. Roll-Formed, Sheet-Metal Edge Moldings and Trim: Type and profile indicated or, if not indicated, manufacturer's standard moldings for edges and penetrations that comply with seismic design requirements; formed from sheet metal of same material, finish, and color as that used for exposed flanges of suspension-system runners.
1. Edge moldings shall fit acoustical panel edge details and suspension systems indicated and match width and configuration of exposed runners unless otherwise indicated.

SECTION 095113 - ACOUSTICAL PANEL CEILING

2. For circular penetrations of ceiling, provide edge moldings fabricated to diameter required to fit penetration exactly.

2.7 ACOUSTICAL SEALANT

- A. Acoustical Sealant: As specified in Section 079200" Joint Sealants."

PART 3 - EXECUTION

3.1 EXAMINATION

- A. Examine substrates, areas, and conditions, including structural framing to which acoustical panel ceilings attach or abut, with Installer present, for compliance with requirements specified in this and other Sections that affect ceiling installation and anchorage and with requirements for installation tolerances and other conditions affecting performance of acoustical panel ceilings.
- B. Examine acoustical panels before installation. Reject acoustical panels that are wet, moisture damaged, or mold damaged.
- C. Proceed with installation only after unsatisfactory conditions have been corrected.

3.2 PREPARATION

- A. Measure each ceiling area and establish layout of acoustical panels to balance border widths at opposite edges of each ceiling. Avoid using less-than-half-width panels at borders unless otherwise indicated, and comply with layout shown on reflected ceiling plans.
- B. Layout openings for penetrations centered on the penetrating items.

3.3 INSTALLATION

- A. Install acoustical panel ceilings according to ASTM C 636/C 636M, seismic design requirements, and manufacturer's written instructions.
- B. Suspend ceiling hangers from building's structural members and as follows:
 1. Install hangers plumb and free from contact with insulation or other objects within ceiling plenum that are not part of supporting structure or of ceiling suspension system.
 2. Splay hangers only where required to miss obstructions; offset resulting horizontal forces by bracing, countersplaying, or other equally effective means.
 3. Where width of ducts and other construction within ceiling plenum produces hanger spacings that interfere with location of hangers at spacings required to support standard suspension-system members, install supplemental suspension members and hangers in form of trapezes or equivalent devices.
 4. Secure wire hangers to ceiling-suspension members and to supports above with a minimum of three tight turns. Connect hangers directly to structure or to inserts, eye screws, or other devices that are secure and appropriate for substrate and that will not deteriorate or otherwise fail due to age, corrosion, or elevated temperatures.
 5. Secure flat, angle, channel, and rod hangers to structure, including intermediate framing members, by attaching to inserts, eye screws, or other devices that are secure and

SECTION 095113 - ACOUSTICAL PANEL CEILING

appropriate for both the structure to which hangers are attached and the type of hanger involved. Install hangers in a manner that will not cause them to deteriorate or fail due to age, corrosion, or elevated temperatures.

6. Do not support ceilings directly from permanent metal forms or floor deck. Fasten hangers to cast-in-place hanger inserts, postinstalled mechanical or adhesive anchors, or power-actuated fasteners that extend through forms into concrete.
 7. When steel framing does not permit installation of hanger wires at spacing required, install carrying channels or other supplemental support for attachment of hanger wires.
 8. Do not attach hangers to steel deck tabs.
 9. Do not attach hangers to steel roof deck. Attach hangers to structural members.
 10. Space hangers not more than 48 inches o.c. along each member supported directly from hangers unless otherwise indicated; provide hangers not more than 8 inches from ends of each member.
 11. Size supplemental suspension members and hangers to support ceiling loads within performance limits established by referenced standards.
- C. Secure bracing wires to ceiling suspension members and to supports with a minimum of four tight turns. Suspend bracing from building's structural members as required for hangers, without attaching to permanent metal forms, steel deck, or steel deck tabs. Fasten bracing wires into concrete with cast-in-place or postinstalled anchors.
- D. Install edge moldings and trim of type indicated at perimeter of acoustical ceiling area and where necessary to conceal edges of acoustical panels.
1. Apply acoustical sealant in a continuous ribbon concealed on back of vertical legs of moldings before they are installed.
 2. Screw attach moldings to substrate at intervals not more than 16 inches o.c. and not more than 3 inches from ends. Miter corners accurately and connect securely.
 3. Do not use exposed fasteners, including pop rivets, on moldings and trim.
- E. Install suspension-system runners so they are square and securely interlocked with one another. Remove and replace dented, bent, or kinked members.
- F. Install acoustical panels with undamaged edges and fit accurately into suspension-system runners and edge moldings. Scribe and cut panels at borders and penetrations to provide precise fit.
1. For square-edged panels, install panels with edges fully hidden from view by flanges of suspension-system runners and moldings.
 2. Paint cut edges of panel remaining exposed after installation; match color of exposed panel surfaces using coating recommended in writing for this purpose by acoustical panel manufacturer.
- 3.4 CLEANING
- A. Clean exposed surfaces of acoustical panel ceilings, including trim, edge moldings, and suspension-system members. Comply with manufacturer's written instructions for cleaning and touchup of minor finish damage.
- B. Remove and replace ceiling components that cannot be successfully cleaned and repaired to permanently eliminate evidence of damage.

SECTION 095113 - ACOUSTICAL PANEL CEILING

END OF SECTION

SECTION 096513 - RESILIENT BASE AND ACCESSORIES

PART 1 - GENERAL

1.1 RELATED DOCUMENTS

- A. Drawings and general provisions of the Contract, including General and Supplementary Conditions and Division 01 Specification Sections, apply to this Section.

1.2 SUMMARY

- A. Section Includes:
 - 1. Resilient base.

1.3 SUBMITTALS

- A. Product Data: For each type of product.
- B. Samples: For each exposed product and for each color and texture specified, not less than 12 inches long.

1.4 DELIVERY, STORAGE, AND HANDLING

- A. Store resilient products and installation materials in dry spaces protected from the weather, with ambient temperatures maintained within range recommended by manufacturer, but not less than 50 deg F or more than 90 deg F.

1.5 FIELD CONDITIONS

- A. Maintain ambient temperatures within range recommended by manufacturer, but not less than 70 deg F or more than 95 deg F, in spaces to receive resilient products during the following time periods:
 - 1. 48 hours before installation.
 - 2. During installation.
 - 3. 48 hours after installation.
- B. After installation and until Substantial Completion, maintain ambient temperatures within range recommended by manufacturer, but not less than 55 deg F or more than 95 deg F.
- C. Install resilient products after other finishing operations, including painting, have been completed.

PART 2 - PRODUCTS

2.1 THERMOSET-RUBBER BASE

- A. Basis of Design: RB-1 Roppe, 700 series wall base
- B. Product Standard: ASTM F 1861, Type TS (rubber, vulcanized thermoset), Group I (solid, homogeneous).
 - 1. Style and Location:

SECTION 096513 - RESILIENT BASE AND ACCESSORIES

- a. Style A, Straight: Provide in areas with carpet & resilient flooring.
2. Thickness: 0.125 inch.
3. Height: 4 inches.
4. Lengths: Coils in manufacturer's standard length.
5. Base Installation" Article.
6. Outside Corners: Job formed.
7. Inside Corners: Job formed.
8. Colors: 125 Fig / existing corridor: match existing

2.2 INSTALLATION MATERIALS

- A. Trowelable Leveling and Patching Compounds: Latex-modified, portland cement based or blended hydraulic-cement-based formulation provided or approved by resilient-product manufacturer for applications indicated.
- B. Adhesives: Water-resistant type recommended by resilient-product manufacturer for resilient products and substrate conditions indicated.
 1. Adhesives shall have a VOC content of 50 g/L or less.

PART 3 - EXECUTION

3.1 EXAMINATION

- A. Examine substrates, with Installer present, for compliance with requirements for maximum moisture content and other conditions affecting performance of the Work.
 1. Verify that finishes of substrates comply with tolerances and other requirements specified in other Sections and that substrates are free of cracks, ridges, depressions, scale, and foreign deposits that might interfere with adhesion of resilient products.
- B. Proceed with installation only after unsatisfactory conditions have been corrected.
 1. Installation of resilient products indicates acceptance of surfaces and conditions.

3.2 PREPARATION

- A. Prepare substrates according to manufacturer's written instructions to ensure adhesion of resilient products.
- B. Fill cracks, holes, and depressions in substrates with trowelable leveling and patching compound; remove bumps and ridges to produce a uniform and smooth substrate.
- C. Do not install resilient products until they are the same temperature as the space where they are to be installed.
 1. At least 48 hours in advance of installation, move resilient products and installation materials into spaces where they will be installed.
- D. Immediately before installation, sweep and vacuum clean substrates to be covered by resilient products.

SECTION 096513 - RESILIENT BASE AND ACCESSORIES

3.3 RESILIENT BASE INSTALLATION

- A. Comply with manufacturer's written instructions for installing resilient base.
- B. Apply resilient base to walls, columns, pilasters, casework and cabinets in toe spaces, and other permanent fixtures in rooms and areas where base is required.
- C. Install resilient base in lengths as long as practical without gaps at seams and with tops of adjacent pieces aligned.
- D. Tightly adhere resilient base to substrate throughout length of each piece, with base in continuous contact with horizontal and vertical substrates.
- E. Do not stretch resilient base during installation.
- F. On masonry surfaces or other similar irregular substrates, fill voids along top edge of resilient base with manufacturer's recommended adhesive filler material.
- G. Job-Formed Corners:
 - 1. Outside Corners: Use straight pieces of maximum lengths possible and form with returns not less than 3 inches in length.
 - a. Form without producing discoloration (whitening) at bends.
 - 2. Inside Corners: Use straight pieces of maximum lengths possible and form with returns not less than 3 inches in length.
 - a. Miter corners to minimize open joints.

3.4 CLEANING AND PROTECTION

- A. Comply with manufacturer's written instructions for cleaning and protecting resilient products.
- B. Protect resilient products from mars, marks, indentations, and other damage from construction operations and placement of equipment and fixtures during remainder of construction period.
- C. Cover resilient products subject to wear and foot traffic until Substantial Completion.

END OF SECTION

SECTION 096513 - RESILIENT BASE AND ACCESSORIES

THIS PAGE INTENTIONALLY LEFT BLANK

SECTION 096516 - RESILIENT SHEET FLOORING

PART 1 - GENERAL

1.1 RELATED DOCUMENTS

- A. Drawings and general provisions of the Contract, including General and Supplementary Conditions and Division 01 Specification Sections, apply to this Section.

1.2 SUMMARY

- A. Section includes vinyl sheet flooring.

1.3 SUBMITTALS

- A. Product Data: For each type of product.
- B. Shop Drawings: For each type of flooring. Include flooring layouts, locations of seams, edges, columns, doorways, enclosing partitions, built-in furniture, cabinets, and cutouts.
- C. Samples for Verification: In manufacturer's standard size, but not less than 6-by-9-inch sections of each different color and pattern of resilient sheet flooring required.
 - 1. For heat-welding bead, manufacturer's standard-size Samples, but not less than 9 inches long, of each color required.
- D. Product Schedule: For resilient sheet flooring. Use same designations indicated on Drawings.
- E. Maintenance Data: For each type of resilient sheet flooring to include in maintenance manuals.

1.4 DELIVERY, STORAGE, AND HANDLING

- A. Store resilient sheet flooring and installation materials in dry spaces protected from the weather, with ambient temperatures maintained within range recommended by manufacturer, but not less than 55 deg F or more than 85 deg F. Store rolls upright.

1.5 FIELD CONDITIONS

- A. Maintain ambient temperatures within range recommended by manufacturer, but not less than 65 deg F or more than 85 deg F, in spaces to receive resilient sheet flooring during the following time periods:
 - 1. 48 hours before installation.
 - 2. During installation.
 - 3. 48 hours after installation.
- B. After installation and until Substantial Completion, maintain ambient temperatures within range recommended by manufacturer, but not less than 55 deg F or more than 85 deg F.
- C. Close spaces to traffic during resilient sheet flooring installation.
- D. Close spaces to traffic for 48 hours after resilient sheet flooring installation.

SECTION 096516 - RESILIENT SHEET FLOORING

- E. Install resilient sheet flooring after other finishing operations, including painting, have been completed.

PART 2 - PRODUCTS

2.1 PERFORMANCE REQUIREMENTS

- A. Fire-Test-Response Characteristics: For resilient sheet flooring, as determined by testing identical products according to ASTM E 648 or NFPA 253 by a qualified testing agency.
 - 1. Critical Radiant Flux Classification: Class I, not less than 0.45 W/sq. cm.

2.2 RESILIENT SHEET FLOORING

- A. Manufacturer: Tarkett
- B. Substitutions: Not Permitted.
- C. Resilient Sheet Flooring (RSF-1)
 - 1. Style: Granit SD
 - 2. Color: Raw Ivory 0719
 - 3. Sheet Width: 6.5' x 75.5'
 - 4. Thickness: 0.08 inch.
 - 5. Seaming Method: Heat welded
 - 6. Product Standard: ASTM F1913
- D. Resilient Sheet Flooring (RSF-2)
 - 1. Style: Granit SD
 - 2. Color: Flannel Blanket 0722
 - 3. Sheet Width: 6.5' x 75.5'
 - 4. Thickness: 0.08 inch.
 - 5. Seaming Method: Heat welded
 - 6. Product Standard: ASTM F1913

2.3 INSTALLATION MATERIALS

- A. Trowelable Leveling and Patching Compounds: Latex-modified, hydraulic-cement-based formulation provided or approved by resilient sheet flooring manufacturer for applications indicated.
- B. Adhesives: Water-resistant type recommended by flooring and adhesive manufacturers to suit resilient sheet flooring and substrate conditions indicated.
 - 1. Basis-of-Design Product: Shaw 4100.
 - 2. Coverage Type: Full-spread application.
- C. Heat Welding Rod: As supplied by indoor flooring manufacturer. Color shall blend with resilient flooring color.

SECTION 096516 - RESILIENT SHEET FLOORING

PART 3 - EXECUTION

3.1 EXAMINATION

- A. Examine substrates, with Installer present, for compliance with requirements for maximum moisture content and other conditions affecting performance of the Work.
 - 1. Verify that finishes of substrates comply with tolerances and other requirements specified in other Sections and that substrates are free of cracks, ridges, depressions, scale, and foreign deposits that might interfere with adhesion of resilient sheet flooring.
- B. Proceed with installation only after unsatisfactory conditions have been corrected.

3.2 PREPARATION

- A. Prepare substrates according to resilient sheet flooring manufacturer's written instructions to ensure adhesion of resilient sheet flooring.
- B. Concrete Substrates: Prepare according to ASTM F 710.
 - 1. Verify that substrates are dry and free of curing compounds, sealers, and hardeners.
 - 2. Remove substrate coatings and other substances that are incompatible with adhesives and that contain soap, wax, oil, or silicone, using mechanical methods recommended by resilient sheet flooring manufacturer. Do not use solvents.
 - 3. Alkalinity and Adhesion Testing: Perform tests recommended by resilient sheet flooring manufacturer. Proceed with installation only after substrate alkalinity falls within range on pH scale recommended by manufacturer in writing, but not less than 7.0 or more than 8.5 pH.
 - 4. Moisture Testing: Proceed with installation only after substrates pass testing according to resilient sheet flooring manufacturer's written recommendations, but not less stringent than the following:
 - a. Perform anhydrous calcium chloride test according to ASTM F 1869. Proceed with installation only after substrates have maximum moisture-vapor-emission rate of 5 lb of water/1000 sq. ft. in 24 hours. Or perform relative humidity test using in situ probes according to ASTM F 2170. Proceed with installation only after substrates have a maximum 80 percent relative humidity level.
- C. Use trowelable concrete based leveling and patching compound with the same moisture vapor tolerance as the adhesive to fill depressions, holes, cracks, grooves or other irregularities in substrate.
- D. Place flooring and installation materials into spaces where they will be installed at least 48 hours before installation. Install flooring materials only after they have reached the same temperature as space where they are to be installed.
- E. Sand the surface of the concrete slab.
- F. Sweep and then vacuum substrates immediately before installation. After cleaning, examine substrate for moisture, alkaline salts, grit, dust or other contamination. Proceed with installation only after unsatisfactory conditions have been corrected.

SECTION 096516 - RESILIENT SHEET FLOORING

3.3 RESILIENT SHEET FLOORING INSTALLATION

- A. Comply with manufacturer's written instructions for installing resilient sheet flooring.
- B. Unroll resilient sheet flooring and allow it to stabilize before cutting and fitting.
- C. Lay out resilient sheet flooring as follows:
 - 1. Maintain uniformity of flooring direction.
 - 2. Minimize number of seams; place seams in inconspicuous and low-traffic areas, at least 6 inches away from parallel joints in flooring substrates.
 - 3. Match edges of flooring for color shading at seams.
 - 4. Avoid cross seams.
- D. Scribe and cut resilient sheet flooring to butt neatly and tightly to vertical surfaces, permanent fixtures, and built-in furniture including cabinets, pipes, outlets, and door frames.
- E. Extend resilient sheet flooring into toe spaces, door reveals, closets, and similar openings.
- F. Maintain reference markers, holes, and openings that are in place or marked for future cutting by repeating on resilient sheet flooring as marked on substrates. Use chalk or other nonpermanent marking device.
- G. Adhere resilient sheet flooring to substrates using a full spread of adhesive applied to substrate to produce a completed installation without open cracks, voids, raising and puckering at joints, telegraphing of adhesive spreader marks, and other surface imperfections.
- H. Seamless Installation:
 - 1. Heat-Welded Seams: Comply with ASTM F 1516. Rout joints and heat weld with welding bead to permanently fuse sections into a seamless flooring. Prepare, weld, and finish seams to produce surfaces flush with adjoining flooring surfaces.
- I. Integral-Flash-Cove Base: Cove resilient sheet flooring 6 inches up vertical surfaces. Support flooring at horizontal and vertical junction with cove strip. Butt at top against cap strip.
 - 1. Install metal corners at inside and outside corners.

3.4 CLEANING AND PROTECTION

- A. Comply with manufacturer's written instructions for cleaning and protecting resilient sheet flooring.
- B. Perform the following operations immediately after completing resilient sheet flooring installation:
 - 1. Remove adhesive and other blemishes from surfaces.
 - 2. Sweep and vacuum surfaces thoroughly.
 - 3. Damp-mop surfaces to remove marks and soil.
- C. Protect resilient sheet flooring from mars, marks, indentations, and other damage from construction operations and placement of equipment and fixtures during remainder of construction period.
- D. Do not apply floor polish.

SECTION 096516 - RESILIENT SHEET FLOORING

- E. Cover resilient sheet flooring until Substantial Completion.

END OF SECTION

SECTION 096516 - RESILIENT SHEET FLOORING

THIS PAGE INTENTIONALLY LEFT BLANK

SECTION 099123 - INTERIOR PAINTING

PART 1 - GENERAL

1.1 RELATED DOCUMENTS

- A. Drawings and general provisions of the Contract, including General and Supplementary Conditions and Division 01 Specification Sections, apply to this Section.

1.2 SUMMARY

- A. Section includes surface preparation and the application of paint systems on interior substrates.

1.3 DEFINITIONS

- A. Eggshell: 10 to 25 units at 60 degrees and 10 to 35 units at 85 degrees, according to ASTM D 523.

1.4 SUBMITTALS

- A. Product Data: For each type of product. Include preparation requirements and application instructions.
- B. Samples for Verification: For each type of paint system and in each color and gloss of topcoat.
 - 1. Submit Samples on rigid backing, 8 inches square.
 - 2. Apply coats on Samples in steps to show each coat required for system.
 - 3. Label each coat of each Sample.
 - 4. Label each Sample for location and application area.
- C. Product List: Cross-reference to paint system and locations of application areas. Use same designations indicated on Drawings and in schedules. Include color designations.

1.5 DELIVERY, STORAGE, AND HANDLING

- A. Store materials not in use in tightly covered containers in well-ventilated areas with ambient temperatures continuously maintained at not less than 45 deg F.
 - 1. Maintain containers in clean condition, free of foreign materials and residue.
 - 2. Remove rags and waste from storage areas daily.

1.6 FIELD CONDITIONS

- A. Apply paints only when temperature of surfaces to be painted and ambient air temperatures are between 50 and 95 deg F.
- B. Do not apply paints when relative humidity exceeds 85 percent; at temperatures less than 5 deg F above the dew point; or to damp or wet surfaces.

SECTION 099123 - INTERIOR PAINTING

PART 2 - PRODUCTS

2.1 PAINT, GENERAL

- A. MPI Standards: Products shall comply with MPI standards indicated and shall be listed in its "MPI Approved Products Lists."
- B. Material Compatibility:
 - 1. Materials for use within each paint system shall be compatible with one another and substrates indicated, under conditions of service and application as demonstrated by manufacturer, based on testing and field experience.
 - 2. For each coat in a paint system, products shall be recommended in writing by topcoat manufacturers for use in paint system and on substrate indicated.
- C. VOC Content: Products shall comply with VOC limits of authorities having jurisdiction and, for interior paints and coatings applied at Project site, the following VOC limits, exclusive of colorants added to a tint base, when calculated according to 40 CFR 59, Subpart D (EPA Method 24).
 - 1. Flat Paints and Coatings: 50 g/L.
 - 2. Nonflat Paints and Coatings: 150 g/L.
 - 3. Primers, Sealers, and Undercoaters: 200 g/L.
- D. Colors: PT-1, Sherwin Williams Alabaster SW 7008. For existing corridor, match existing.
- E. Surplus: Provide three gallons of each paint color specified on the interior finish schedule for patching & repair.

PART 3 - EXECUTION

3.1 EXAMINATION

- A. Examine substrates and conditions, with Applicator present, for compliance with requirements for maximum moisture content and other conditions affecting performance of the Work.
- B. Maximum Moisture Content of Substrates: When measured with an electronic moisture meter as follows:
 - 1. Gypsum Board: 12 percent.
- C. Gypsum Board Substrates: Verify that finishing compound is sanded smooth.
- D. Verify suitability of substrates, including surface conditions and compatibility, with existing finishes and primers.
- E. Proceed with coating application only after unsatisfactory conditions have been corrected.
 - 1. Application of coating indicates acceptance of surfaces and conditions.

3.2 PREPARATION

- A. Comply with manufacturer's written instructions and recommendations in "MPI Architectural Painting Specification Manual" applicable to substrates and paint systems indicated.

SECTION 099123 - INTERIOR PAINTING

- B. Remove hardware, covers, plates, and similar items already in place that are removable and are not to be painted. If removal is impractical or impossible because of size or weight of item, provide surface-applied protection before surface preparation and painting.
 - 1. After completing painting operations, use workers skilled in the trades involved to reinstall items that were removed. Remove surface-applied protection if any.
- C. Clean substrates of substances that could impair bond of paints, including dust, dirt, oil, grease, and incompatible paints and encapsulants.
 - 1. Remove incompatible primers and reprime substrate with compatible primers or apply tie coat as required to produce paint systems indicated.
- D. Steel Substrates: Remove rust, loose mill scale, and shop primer, if any. Clean using methods recommended in writing by paint manufacturer. but not less than the following:
 - 1. SSPC-SP 3.
- E. Shop-Primed Steel Substrates: Clean field welds, bolted connections, and areas where shop paint is abraded. Paint exposed areas with the same material as used for shop priming to comply with SSPC-PA 1 for touching up shop-primed surfaces.
- F. Galvanized-Metal Substrates: Remove grease and oil residue from galvanized sheet metal by mechanical methods to produce clean, lightly etched surfaces that promote adhesion of subsequently applied paints.
- G. Aluminum Substrates: Remove loose surface oxidation.

3.3 APPLICATION

- A. Apply paints according to manufacturer's written instructions and to recommendations in "MPI Manual."
 - 1. Use applicators and techniques suited for paint and substrate indicated.
 - 2. Paint surfaces behind movable equipment and furniture same as similar exposed surfaces. Before final installation, paint surfaces behind permanently fixed equipment or furniture with prime coat only.
 - 3. Paint front and backsides of access panels, removable or hinged covers, and similar hinged items to match exposed surfaces.
 - 4. Do not paint over labels of independent testing agencies or equipment name, identification, performance rating, or nomenclature plates.
 - 5. Primers specified in painting schedules may be omitted on items that are factory primed or factory finished if acceptable to topcoat manufacturers.
- B. Tint each undercoat a lighter shade to facilitate identification of each coat if multiple coats of same material are to be applied. Tint undercoats to match color of topcoat, but provide sufficient difference in shade of undercoats to distinguish each separate coat.
- C. If undercoats or other conditions show through topcoat, apply additional coats until cured film has a uniform paint finish, color, and appearance.
- D. Apply paints to produce surface films without cloudiness, spotting, holidays, laps, brush marks, roller tracking, runs, sags, ropiness, or other surface imperfections. Cut in sharp lines and color breaks.

SECTION 099123 - INTERIOR PAINTING

- E. Painting Fire Suppression, Plumbing, HVAC, Electrical, Communication, and Electronic Safety and Security Work:
 - 1. Paint the following work where exposed in occupied spaces:
 - a. Equipment, including panelboards.
 - b. Uninsulated metal piping.
 - c. Uninsulated plastic piping.
 - d. Pipe hangers and supports.
 - e. Metal conduit.
 - f. Plastic conduit.
 - g. Duct, equipment, and pipe insulation having cotton or canvas insulation covering or other paintable jacket material.
 - h. Other items as directed by Architect.
 - 2. Paint portions of internal surfaces of metal ducts, without liner, behind air inlets and outlets that are visible from occupied spaces.

3.4 CLEANING AND PROTECTION

- A. At end of each workday, remove rubbish, empty cans, rags, and other discarded materials from Project site.
- B. After completing paint application, clean spattered surfaces. Remove spattered paints by washing, scraping, or other methods. Do not scratch or damage adjacent finished surfaces.
- C. Protect work of other trades against damage from paint application. Correct damage to work of other trades by cleaning, repairing, replacing, and refinishing, as approved by Architect, and leave in an undamaged condition.
- D. At completion of construction activities of other trades, touch up and restore damaged or defaced painted surfaces.

3.5 INTERIOR PAINTING SCHEDULE

- A. E. Gypsum Board Substrates:
 - 1. Institutional Low-Odor/VOC Latex System:
 - a. Prime Coat: Primer sealer, interior, institutional low odor/VOC, MPI #149.
 - b. Intermediate Coat: Latex, interior, institutional low odor/VOC, matching topcoat.
 - c. Topcoat: Latex, interior, institutional low odor/VOC (MPI Gloss Level 3), MPI #145.

END OF SECTION

SECTION 102600 - WALL AND DOOR PROTECTION

PART 1 - GENERAL

1.1 RELATED DOCUMENTS

- A. Drawings and general provisions of the Contract, including General and Supplementary Conditions and Division 01 Specification Sections, apply to this Section.

1.2 SUMMARY

- A. Section Includes:
 - 1. Corner guards.
 - 2. Impact-resistant wall coverings.

1.3 SUBMITTALS

- A. Product Data: For each type of product.
- B. Shop Drawings: For each type of wall and door protection showing locations and extent.
 - 1. Include plans, elevations, sections, and attachment details.
- C. Samples: For each exposed product and for each color and texture specified
- D. Maintenance Data
- E. Warranty: Sample of special warranty

1.4 DELIVERY, STORAGE, AND HANDLING

- A. Store wall and door protection in original undamaged packages and containers inside well-ventilated area protected from weather, moisture, soiling, extreme temperatures, and humidity.
 - 1. Maintain room temperature within storage area at not less than 70 deg F during the period plastic materials are stored.
 - 2. Keep plastic materials out of direct sunlight.
 - 3. Store plastic wall- and door-protection components for a minimum of 72 hours, or until plastic material attains a minimum room temperature of 70 deg F.
 - a. Store corner-guard covers in a vertical position.

1.5 WARRANTY

- A. Special Warranty: Manufacturer agrees to repair or replace components of wall- and door-protection units that fail in materials or workmanship within specified warranty period.
 - 1. Failures include, but are not limited to, the following:
 - a. Structural failures including detachment of components from each other or from the substrates, delamination, and permanent deformation beyond normal use.
 - b. Deterioration of metals, metal finishes, plastics, and other materials beyond normal use.
 - 2. Warranty Period: Five years from date of Substantial Completion.

SECTION 102600 - WALL AND DOOR PROTECTION

PART 2 - PRODUCTS

2.1 MANUFACTURERS

- A. Source Limitations: Obtain wall-protection products from single source from single manufacturer.

2.2 PERFORMANCE REQUIREMENTS

- A. Surface Burning Characteristics: Comply with ASTM E 84 or UL 723; testing by a qualified testing agency. Identify products with appropriate markings of applicable testing agency.
 - 1. Flame-Spread Index: 25 or less.
 - 2. Smoke-Developed Index: 450 or less.

2.3 CORNER GUARDS

- A. Surface-Mounted, Stainless Steel Corner Guards (CG-1): Assembly including mounting hardware; fabricated with 90- or 135-degree turn to match wall condition.
 - 1. Basis of design product: Acrovyn
 - 2. Sheet Thickness: per manufacturer
 - 3. Corner Guard Height: 48" unless noted otherwise.
 - 4. Mounting: Adhesive/Screws.

2.4 IMPACT-RESISTANT WALL COVERINGS

- A. Impact-Resistant Sheet Wall Covering (IRP-1) Fabricated from semi-rigid, plastic sheet wall-covering material.
 - 1. Basis of design product: Acrovyn
 - 2. Sheet Thickness: 0.060 inch.
 - 3. Sheet Height: 48" or as indicated on drawings
 - 4. Texture: Suede.
 - 5. Colors: 100 Eggshell
 - 6. Trim and Joint Moldings: Extruded rigid plastic that matches sheet wall covering color.
 - 7. Mounting: Adhesive.

2.5 FABRICATION

- A. Fabricate wall and door protection according to requirements indicated for design, performance, dimensions, and member sizes, including thicknesses of components.
 - 1. Sheet Thickness of 0.060 Inch
- B. Factory Assembly: Assemble components in factory to greatest extent possible to minimize field assembly. Disassemble only as necessary for shipping and handling.
- C. Quality: Fabricate components with uniformly tight seams and joints and with exposed edges rolled. Provide surfaces free of wrinkles, chips, dents, uneven coloration, and other imperfections. Fabricate members and fittings to produce flush, smooth, and rigid hairline joints.

SECTION 102600 - WALL AND DOOR PROTECTION

2.6 FINISHES

- A. Protect finishes on exposed surfaces from damage by applying a strippable, temporary protective covering before shipping.
- B. Appearance of Finished Work: Noticeable variations in same piece are not acceptable. Variations in appearance of adjoining components are acceptable if they are within the range of approved Samples and are assembled or installed to minimize contrast.

PART 3 - EXECUTION

3.1 EXAMINATION

- A. Examine substrates and wall areas, with Installer present, for compliance with requirements for installation tolerances and other conditions affecting performance of the Work.
- B. Examine walls to which wall and door protection will be attached for blocking, grounds, and other solid backing that have been installed in the locations required for secure attachment of support fasteners.
 - 1. For wall and door protection attached with adhesive, verify compatibility with and suitability of substrates, including compatibility with existing finishes or primers.
- C. Proceed with installation only after unsatisfactory conditions have been corrected.

3.2 PREPARATION

- A. Complete finishing operations, including painting, before installing wall and door protection.
- B. Before installation, clean substrate to remove dust, debris, and loose particles.

3.3 INSTALLATION

- A. Installation Quality: Install wall and door protection according to manufacturer's written instructions, level, plumb, and true to line without distortions. Do not use materials with chips, cracks, voids, stains, or other defects that might be visible in the finished Work.
- B. Accessories: Provide splices, mounting hardware, anchors, trim, joint moldings, and other accessories required for a complete installation.
 - 1. Provide anchoring devices and suitable locations to withstand imposed loads.
 - 2. Where splices occur in horizontal runs of more than 20 feet splice aluminum retainers and plastic covers at different locations along the run, but no closer than 12 inches apart.
 - 3. Adjust end and top caps as required to ensure tight seams.
- C. Impact-Resistant Wall Covering: Install top and edge moldings, corners, and divider bars as required for a complete installation.

3.4 CLEANING

- A. Immediately after completion of installation, clean plastic covers and accessories using a standard ammonia-based household cleaning agent.

SECTION 102600 - WALL AND DOOR PROTECTION

- B. Remove excess adhesive using methods and materials recommended in writing by manufacturer.

END OF SECTION

SECTION 200000 – MECHANICAL GENERAL REQUIREMENTS

PART 1 - GENERAL

1.1 SUMMARY

- A. Section Includes: Supplemental requirements in addition to Division 1 - General Requirements applicable to all Divisions 20, 21, 22, 23, 25 - Mechanical specification sections.
- B. Project includes installation of a magnetic resonance imaging (MRI) machine. All materials and equipment installed inside the magnet room shall be non-magnetic.
- C. Related Sections:
 - 1. 200513 - Common Motor Requirements
 - 2. 200529 - Mechanical Hangers and Supports
 - 3. 200553 - Mechanical Identification
 - 4. 200700 - Mechanical Insulation
 - 5. 204100 - Mechanical Demolition
 - 6. 221100 - Domestic Water Piping and Specialties
 - 7. 221300 - Sanitary Waste and Vent Piping and Specialties
 - 8. 230593 - Testing, Adjusting and Balancing
 - 9. 232113 - Hydronic Piping and Specialties
 - 10. 233100 - Ducts and Accessories
 - 11. 233700 - Air Outlets and Inlets
 - 12. 236400 - Packaged Water Chillers
 - 13. 238200 - Terminal Heating and Cooling Units
 - 14. 259000 - Sequence of Operations

1.2 REFERENCES

- A. Codes and Standards:
 - 1. Perform work in accordance with the legally enacted editions of applicable international, state and local codes with locally accepted amendments to include:
 - a. 2018 International Building Code (IBC).
 - b. 2018 International Mechanical Code (IMC).
 - c. 2018 International Fuel Gas Code (IFGC).
 - d. 2018 Uniform Plumbing Code (UPC).
 - e. 2018 International Fire Code (IFC).
 - f. 2018 NFPA 70, National Electric Code (NEC).
 - g. ASCE 7-16, Minimum Design Loads and Associated Criteria for Buildings and Other Structures.
 - h. Standard for Accessible and Usable Buildings and Facilities (ANSI A117.1-2017).
 - 2. Standards: Reference to the following standards infers that installation, equipment and material shall be within the limits for which it was designed, tested and approved, in conformance with the current publications and standards of the following organizations:
 - a. American Gas Association - AGA.
 - b. American National Standards Institute - ANSI.

SECTION 200000 – MECHANICAL GENERAL REQUIREMENTS

- c. American Society of Heating Refrigerating and Air Conditioning Engineers - ASHRAE.
- d. American Society of Mechanical Engineers - ASME.
- e. American Society for Testing and Materials - ASTM.
- f. National Electrical Manufacturers' Association - NEMA.
- g. National Fire Protection Association - NFPA.
- h. Sheet Metal and Air Conditioning Contractors National Association, Inc. - SMACNA.

B. Definitions:

1. “Accessible” means arranged so that an appropriately dressed man 6'-2" tall, weighing 250 pounds, may approach the area in question with the tools and products necessary for the work intended; and may then position himself to properly perform the task to be accomplished, without disassembly or damage to the surrounding installation.
2. “Authority Having Jurisdiction” is the individual official, board, department, or agency established and authorized by the political subdivision created by law to administer and enforce the provisions of the Code as adopted or amended.
3. “As Specified” denotes a product, system, or installation that:
 - a. Includes salient characteristics identified in the Drawings and Specifications.
 - b. Meets the requirements of the “Basis of Design”.
 - c. Is produced by a manufacturer listed as acceptable on the Drawings or in the Specifications.
4. “Basis of Design” refers to products around which the design was prepared. Some or all of the particular characteristics of Basis of Design products may be critical to the fit or performance of the completed installation. Such characteristics are often subtle. Where substitutions are made to products that are the Basis of Design, the Contractor is alerted that nominally acceptable substitutions may produce undesirable side effects such as products that no longer fit the space due to increased product dimensions. The Contractor is responsible for resolving impacts of substitutions. Approval of a substitution request does not relieve the Contractor of complying with the design intent and applicable Codes. Reference to a specific manufacturer’s product (even as “Basis of Design”) does not necessarily establish acceptability of that product without regard to compliance with other provisions of these specifications.
5. “Contracting Agency” is the Owner as defined in the General Conditions of the Contract.
6. “Demolish” means to permanently remove a component, equipment, or system and its appurtenances with no intent for reuse and to properly disposal of it.
7. “Furnish” means to purchase material as shown and specified, and cart the material to an approved location at the site or elsewhere, as noted or agreed, to be installed by supporting crafts.
8. “Install” means to set in place and connect, ready for use and in complete and properly operating finished condition, material that has been furnished.
9. “Product” is a generic term that includes materials, equipment, fixtures and any physical item used on the project.
10. “Provide” means furnish products, labor, subcontracts, and appurtenances required and install to a complete and properly operating, finished condition.
11. “Remove” means to remove a component, equipment, or system and its appurtenances and either store it for re-installation/reuse, or turn it over to the Contracting Agency.

SECTION 200000 – MECHANICAL GENERAL REQUIREMENTS

12. “Rough-in and Connect” means provide an appropriate system connection such as water services with stops, continuous wastes with traps, shutoff valves, and piping connections, testing, etc., for proper operation, ready for furnished products to be installed. Equipment furnished is received, uncrated, assembled and set in place by supporting crafts unless prior arrangements are made to hire the rough-in installer for this work.
13. “Serviceable” means arranged so that the component or product in question may be properly removed and replaced without disassembly, destruction or damage to the surrounding installation. "Serviceable" components shall be "accessible".
14. “Shop Drawings” are dimensioned working construction drawings drawn to scale to show an entire area of work in sufficient detail to demonstrate service and maintenance clearances and coordination of all trades.
15. “Substitution” is a product, system or installation that is not by a listed manufacturer or does not conform to all salient characteristics identified in the Project Manual, but that the Contractor warrants meets specific requirements listed in the Project Manual.
16. “System Drawing” is a diagrammatic engineered drawing that shows the interconnection and relationship between products to demonstrate how the products interact to accomplish the function intended. Examples of system drawings include plumbing diagrams, control and instrumentation diagrams, and wiring diagrams. Some drawings, such as dimensioned and complete Fire Suppression Drawings may be both System Drawings and Shop Drawings.

1.3 SYSTEM DESCRIPTION

A. Performance Requirements:

1. Provide labor, products and services required for the complete installation, checkout, and startup of mechanical systems shown and specified. Coordinate related work, including the work of other crafts, to provide each system complete and in proper operating order.
2. Cooperate with others involved in the project; with due regard to their work, to promote rapid completion of the entire project.
3. Become thoroughly familiar with the local conditions under which the work is to be performed. Schedule work with regard to seasons, weather, climatic conditions, and other local conditions that may affect the progress and quality of the work.
4. Coordinate and perform demolition in support of the project whether or not such requirements are described on the Drawings. Restore systems that are to remain but that are affected in any way by demolition work. Conduct a site visit prior to bid to determine Scope.
5. In general, the mechanical, electrical and building automation systems are interrelated. Coordinate the interface and operation of systems so that interrelated systems operate in proper synchronization and balance.
6. Work and materials shall be in accordance with requirements of the applicable State and local Codes, regulations and ordinances, and the rules and regulations of other Authorities Having Jurisdiction. Nothing in drawings and specifications shall be construed to permit work not in conformance with applicable codes, rules, and regulations.
7. Where drawings or specifications call for a material or construction of a better quality or larger sizes than required by the above-mentioned Codes, rules and regulations, the provision of the specifications shall take precedence.
8. Furnish without any extra charge any additional material and labor when required for compliance with the listed codes, rules and regulations, even though the work may not be mentioned in the specifications or shown on the drawings. It is the responsibility of the

SECTION 200000 – MECHANICAL GENERAL REQUIREMENTS

successful bidder to bid in accordance with the minimum requirements of the applicable codes, rules, and regulations.

B. Fire Protection Requirements:

1. Review the Contract Documents and Owner furnished equipment and determine if portion of the existing fire protection system will be affected by the temporary or permanent implementation of portion of this work. Provide Owner and Engineer list of specific fire protection and detection systems affected before proceeding with design or demolition. Follow fire global recommendations.
2. Provide services of an Owner approved and qualified fire protection contractor to modify and add sprinkler heads to the existing sprinkler system for complete coverage under this contract. Materials, equipment, sprinkler heads, piping, and design criteria shall meet AHJ and Owner requirements.
3. Existing fire protection sprinkler system shall remain active until the new fire protection system is approved to provide protection. Existing system shall be modified to provide protection, reviewed by Engineer, and approved by Owner and AHJ. Alternate methods of providing fire watch or other AHJ approved protection shall be reviewed and approved by the Owner.
4. Sprinkler system piping shall be steel except where installed in MRI room; other than schedule 40 steel shall have a corrosion resistance ratio (CRR) equal to or greater than 1.0. Submit a statement that the piping complies with NFPA 13 standards; include this CRR data in product submittal. Installed system to have a corrosion resistance ratio equal or greater than 1.0.
5. In addition to NFPA 13 criteria provide seismic clearance for sprinkler piping and heads per IBC and ASCE 07-16. Flexible braided SS hose assemblies for sprinkler heads unless otherwise approved.
6. Provide sprinkler heads with flexible braided SS hose in areas where ceilings will be replaced, upgraded, or modified. Provide concealed sprinkler heads for areas modified. Response type and color to match existing. Provide sealing gasket for rooms requiring differential pressure control.
7. Work shall be scheduled to minimize disruption of fire service, coordinate with Owner for shut down and maintain a fire watch when system is inoperable.
8. Determination of existing building sprinkler coverage and conditions, including water pressure and flow are the responsibility of the contractor. Field check existing piping, provide flow test, make calculations, and provide other services to properly design or modify the systems, as required by the authority having jurisdiction and for the work.
9. Submit fire protection drawings, calculations, and cut sheets to Engineer, Owner's insurance agency, and authority having jurisdiction (AHJ). Product data, shop drawings, and calculations shall be submitted together for review; partial submittals not allowed.
10. Obtain approval from the Owner and AHJ before starting installation of the system. Submit correspondence with the insurance company and the AHJ to the Owner and Engineer. Drawings and calculations shall include the NICET certification and State of Alaska permit IIC numbers and signature or Alaska stamp of a licensed professional engineer and the fire protection contractor's Alaska specialty license number.
11. Obtain approval of the Owner prior to ordering, fabricating, or installing part of the system. Head locations are subject to this review and approval.
12. Approved full size as-built drawings, electronic copy of as-builts in pdf and dwg formats, and O&M manual shall be submitted.

SECTION 200000 – MECHANICAL GENERAL REQUIREMENTS

C. Seismic Design and Installation Requirements:

1. The hospital is an essential facility and the seismic component importance factor (I_p) for the equipment is 1.5.
2. Coordinate with Structural and Architectural criteria and provide seismic design, anchors, and restraint devices to resist loads per IBC, chapter 16 and ASCE 7-16.
3. Coordinate with Structural requirements to ensure attachment points can accommodate forces.
4. Contractor's seismic design shall be a deferred submittal and submitted to the AHJ. Coordinate with special inspections per IBC Chapter 17 and AHJ requirements.

1.4 PRE-INSTALLATION MEETINGS

- A. Meet with and coordinate Divisions 20, 21, 22, 23, 25 work with the interrelated work of other trades including Architectural, Civil, Structural, Mechanical and Electrical to identify and resolve potential conflicts.
- B. Prior to installation of any Division 20, 21, 22, 23, and 25 component, coordinate installation with trades responsible for portions of other related sections of the Project Manual.

1.5 SUBMITTALS

- A. Refer to Division 1 for general submittal requirements for the items listed below, supplemented with the additional requirements listed. In addition, prepare Divisions 20, 21, 22, 23, 25 submittals in accordance with the following, to include any supplemental requirements listed in the specific specification section:
- B. General:
 1. The Contracting Agency's obligation to review submittals and to return them in a timely manner is conditioned upon the prior review and approval of the submittals by the Contractor as required by the Construction Contract.
 2. Submittal review is for general design and arrangement only and does not relieve the Contractor from any of the requirements of the Project Manual.
 - a. Submittals will not be checked for quantity, dimension, fit, or for proper technical design of manufactured equipment.
 - b. Provision of a complete and satisfactory working installation is the responsibility of the Contractor.
 3. Furnish suppliers with the applicable portions of the Project Manual and review and verify that the suppliers' submittals clearly represent products which comply with the Project Manual.
 4. Master Submittal Log]
 - a. Create and maintain a master submittal log for items submitted in Divisions 20, 21, 22, 23, 25, including test results, certifications, record drawings, etc.
 - b. Submit master submittal log, independent of other submittals, as the first submittal for review and approval by the Contracting Agency.
 - c. Update submittal log with each submittal action.

SECTION 200000 – MECHANICAL GENERAL REQUIREMENTS

- d. Share an electronic copy with Contracting Agency and Engineer at two week intervals, or as requested by the Contracting Agency.

C. Coordination:

1. Prior to a submittal's submission for approval, hold a meeting of all construction trades to review shop drawings and submittals. Each trade shall cross-check shop drawings and submittals for conflicts, clearances, physical space allocation and routing, discrepancies, dimensional errors, omissions, contradictions, departures from the Contract requirements, correct electrical/mechanical services and connections, and provisions for commissioning.
2. Review, revise, correct, and appropriately annotate submittals prior to submission for approval.
3. Keep a current copy of approved submittals and the submittal log at the job site.

D. Electronic Submittals:

1. Provide electronic submittals in PDF format in addition to hard copy submittal. Maximum file size to be coordinated with Contracting Agency.
2. Follow the organization and formatting required for paper submittals.
3. Provide electronic bookmarks within the PDF document in place of tabs and sub-tabs.
4. If individual PDF files are provided for a product or shop drawing sheet(s), organize files into folders and name files and folders to correspond with applicable specification sections or drawing titles.
5. Create PDF documents without security, to be searchable, and to allow copy and paste. For scanned documents, run the optical character recognition (OCR) function to ensure the document is searchable and can be copied and pasted.
6. Reduce PDF file size by removing data and file creation elements not needed for final file presentation.

E. Product Data:

1. General:
 - a. This section describes in detail the preparation of mechanical product submittals. Submittals not provided as described shall be rejected without review. This procedure is designed to accelerate and improve the accuracy of the technical review process, as well as, simplify the preparation of the Installation, Operation, and Maintenance Manuals (IO&Ms).
 - b. Product data for each specification section shall be submitted in one complete package, except as noted in this section.
2. Submittal Organization:
 - a. Organize product submittal information in the same order as the products are specified. Provide a separate tabbed divider for each Divisions 20, 21, 22, 23, 25 specification section. Provide the typed section number on each tab.
 - b. Within each section, organize product information in the same order as products are specified in Part 2 of each applicable specification section. Provide sub-tabs within each section for each separate product article. Provide the typed product article number on each tab.
 - c. Provide product submittal information for each product specified in 8-1/2" x 11" format. Fold-out 11" x 17" format is also acceptable.

SECTION 200000 – MECHANICAL GENERAL REQUIREMENTS

- d. If a particular specified product is being omitted from the product submittal or will not be used for the project, provide a single sheet within the article tab identifying the product and annotated with a brief reason why the product is not being submitted, for example: “NOT USED,” “NO SUBMITTAL REQUIRED,” “TO BE SUBMITTED BY (PROVIDE DATE),” etc. This will inform the reviewer that the product was not overlooked.
 - e. Partial submittals from individual subcontractors may be provided which cover a particular sub-contractor’s scope of work. In this case, arrange partial submittals by system classification such as: PLUMBING, HEATING, FIRE SUPPRESSION, VENTILATION, BUILDING AUTOMATION SYSTEM, etc. Within each system classification, arrange product submittals by specification section, as described, such that each specification section can easily be reorganized into a master set of Divisions 20, 21, 22, 23, 25 product submittals organized by specification section. This will greatly simplify the preparation of IO&M manuals as described below.
 - f. Bind product submittal information in identical 3 inch wide, hard-backed, loose-leaf, 3 ring binders with clear front and spine insert pockets. Divide information into multiple volumes so that the pages in each binder rest naturally on one side of rings.
 - g. Provide a master table of contents at the front of each volume which lists the Divisions 20, 21, 22, 23, 25 specification sections and indicates which sections are located within each volume.
 - h. Provide a table of contents within each section which lists the Part 2 products for that section in the same order as the applicable specification section.
 - i. Provide identical cover and spine inserts for each product submittal volume, to include the following typed information:
 - 1). The Contracting Agency Name.
 - 2). Project Name.
 - 3). Contractor Name.
 - 4). Subcontractor Name preparing the submittal.
 - 5). Date that the submittal or resubmittal was initiated.
 - 6). “Mechanical Product Submittals” or “Plumbing Product Submittals” etc. as appropriate.
 - 7). “Volume 1 of X, Volume 2 of X,” etc.
3. Product Information:
- a. Indicate manufacturer's name and address, and local supplier's name, address, phone number.
 - b. Indicate each product as “Basis of Design”, “Specified Equal” or “Proposed Substitution.”
 - c. Identify catalog designation and/or model number.
 - d. Provide manufacturer’s product literature. Neatly annotate to indicate specified salient features, appurtenances and performance criteria for each product specified to demonstrate compliance with the Project Manual to include scheduled information, drawing information and specified information.
 - e. Indicate product deviations from the Project Manual and mark out non-applicable items on generic “cut-sheets.”
 - f. Include manufacturer provided dimensioned equipment drawings with rough-in mechanical and electrical connections.
 - g. Include operation characteristics, performance curves and rated capacities.
 - h. Include motor characteristics and wiring diagrams.
 - i. Include weight of equipment. Including accessories.

SECTION 200000 – MECHANICAL GENERAL REQUIREMENTS

- j. Provide basic manufacturer's installation instructions.
4. Product Substitutions:
- a. Clearly indicate both in the section table of contents and on the individual product submittal information each proposed substitution, deviation or change from the product as described in the Project Manual.
 - b. Submittal approval does not include substitutions, deviations or changes from the requirements of the Project Manual unless they are specifically itemized and approved. The term "No Exceptions Taken" will not apply to substitutions, deviations or changes not clearly identified.
 - c. Provision of a satisfactory working installation of equal quality to the system as described in the Project Manual shall be the responsibility of the Contractor.
 - d. Correct unapproved deviations from the Project Manual discovered in the field as directed by and at no additional cost to the Contracting Agency.
 - e. Cost of any design modifications as a result of proposed product substitutions shall be borne by the Contractor.
- F. System Drawings:
- 1. Submit System Drawings for dynamic elements/systems of the project which are performance specified to include but not limited to: Fire Suppression Systems, Building Automation Systems and stand-alone packaged equipment.
 - 2. Prepare system drawings on full sized sheets of the same size as the original construction drawings.
 - 3. Include with each system a sequence of operation narrative which describes each mode of system operation in sufficient detail to demonstrate compliance with the Project Manual to the satisfaction of the Contracting Agency.
- G. Shop Drawings:
- 1. General:
 - a. The Project Manual documents are not intended for nor are they suitable for use as shop drawings. Project Manual documents shall not be utilized for the actual fabrication or installation of products or equipment.
 - b. The Drawings are partly diagrammatic and do not show all offsets in piping or ducts, and may not show in minute detail all features of the installation; however, provide systems complete and in proper operating order.
 - c. Locations of products are approximate unless dimensioned.
 - d. Divisions 20, 21, 22, 23, 25 products and systems shall not be installed without shop drawings approved by the Contracting Agency.
 - e. Rework, changes or additional engineering support required as a result of the installation of products and systems prior to the approval of applicable shop drawings by the Contracting Agency shall be provided at the Contractor's expense.
 - f. Drawing symbols used for basic materials, equipment and methods are commonly used by the industry. Special items are identified by a supplementary list of graphical illustrations, or identified on the drawings or specifications.
 - 2. Preparation:
 - a. Review each Divisions 20, 21, 22, 23, 25 specification section and identify the shop drawing requirements.

SECTION 200000 – MECHANICAL GENERAL REQUIREMENTS

- b. Combine the shop drawing requirements first by system (i.e. ventilation system, heating system, plumbing system, etc.) and then by area (i.e. fan room, boiler room, etc.).
 - c. Prepare shop drawings on full sized sheets of the same size as the original construction drawings.
 - d. Arrange shop drawings to scale, showing dimensions where accuracy of location is necessary for coordination or communication purposes.
 - e. Incorporate the actual dimensions and configurations of the products and systems approved through the product submittal process into the shop drawings.
 - f. Provide dimensioned maintenance clearance areas around each product as recommended by the manufacturer.
 - g. Coordinate Divisions 20, 21, 22, 23, 25 work with the interrelated work of other trades including Architectural, Civil, Structural, and Electrical.
 - h. Identify and provide recommendations to resolve major conflicts which may impact the design of the systems as shown. Such conflicts will be resolved during the shop drawing review process.
 - i. Identify locations where field coordination between various trades is necessary to avoid conflicts.
 - j. Indicate elevation of piping, ductwork and equipment above or below finished floor at various locations and in sufficient detail to demonstrate clearance from structural elements and the work of other trades.
 - k. Coordinate placement of openings and holes through structure, walls, floors, ceilings, and roof with Structural and Architectural.
3. Submittal:
- a. Submit dimensioned shop drawings as specified to demonstrate proper planning and sequencing of the applicable trades for the installation and arrangement of Divisions 20, 21, 22, 23, 25 with respect to other interrelated work.
 - b. Partial shop drawings submittals (i.e. heating system only) will be rejected without review, as the interrelationship with other related work and overall system fit cannot be evaluated.
 - c. It is assumed that shop drawings submitted for review have been thoroughly prepared and coordinated and that the products and systems can and shall be installed as shown. Conflicts which are not clearly identified and annotated on the submitted shop drawings are assumed not to exist.
 - d. Installation conflicts arising from the failure to properly coordinate the work of related trades shall be provided at the Contractor's expense.

H. Certificates:

1. Review the submittal requirements for Certificates for each Divisions 20, 21, 22, 23, 25 specification section.
2. Submit copies of certificates as specified. This information may be included within the Installation, Operations and Maintenance (IO&M) Manuals as determined by the Contracting Agency.

I. Test and Evaluation Reports:

1. Review the submittal requirements for Test and Evaluation Reports for each Divisions 20, 21, 22, 23, 25 specification section.

SECTION 200000 – MECHANICAL GENERAL REQUIREMENTS

2. Submit copies of reports as specified. Also include these reports within the Installation, Operations and Maintenance (IO&M) Manuals as determined by the Contracting Agency.
- J. Installation, Operations and Maintenance (IO&M) Manuals:
1. Review the submittal requirements for IO&M manuals for each Divisions 20, 21, 22, 23, 25 specification section.
 2. Begin the preparation of the mechanical IO&M manuals with a complete and fully approved set of mechanical product data submittals organized, annotated and with the product information as indicated within the “Product Data” submittals article above and in each Divisions 20, 21, 22, 23, 25 section.
 3. Next, augment each individual product submittal with the written installation, operations and maintenance information for each approved product. This type of information is not applicable (or available) for bulk commodity or simplistic products such as copper pipe, basic pipe hangers or equipment tags, etc.
 4. Annotate the installation, operations and maintenance information to indicate applicable information for the specific equipment model(s) installed.
 5. Maintenance information shall include:
 - a. Preventive maintenance requirements for each product, including the recommended frequency of performing each preventive maintenance task.
 - b. Instructions for troubleshooting, minor repair and adjustments required for preventive maintenance routines, limited to repairs and adjustments that may be performed without special tools or test equipment and that require no extensive special training or skills.
 - c. Information of a maintenance nature covering warranty items, etc., that have not been discussed in the manufacturers’ literature.
 - d. Information on the spare and replacement parts for each product and system. Properly identify each part by part number and manufacturer.
 - e. Recommended spare parts list.
 6. Organize the IO&M manual information by specification section (not by sub-contractor) with a tabbed divider separating each section. Provide the typed section number on each tab.
 7. Within each section, organize the product information in the same order as the products are specified in Part 2 of each applicable section. Provide sub-tabs within each section for each product. Provide the typed product article number on each tab.
 8. Bind the information in identical 3 inch wide; hard-backed, loose-leaf, 3 ring binders with clear front and spine insert pockets. Divide information into multiple volumes so that the pages in each binder rest naturally on one side of rings.
 9. Provide a master table of contents at the front of each volume which lists the Divisions 20, 21, 22, 23, 25 specification sections and indicates which sections are located within each volume.
 10. Provide a table of contents within each section which lists the Part 2 products for that section in the same order as the applicable specification section.
 11. Provide identical cover and spine inserts for each IO&M manual volume, to include the following typed information:
 - a. The Contracting Agency Name.
 - b. Project Name.
 - c. “Mechanical Installation, Operations and Maintenance Manual”.
 - d. “Volume 1 of X, Volume 2 of X,” etc.

SECTION 200000 – MECHANICAL GENERAL REQUIREMENTS

12. Submit copies of Operation and Maintenance Manuals in electronic format (Adobe PDF).

1.6 CLOSEOUT SUBMITTALS

A. Warranty Documentation:

1. Review the manufacturer's warranty requirements for each Divisions 20, 21, 22, 23, 25 specification section. Unless stated otherwise, provide 1-year warranty.
2. Submit required warranty documentation to the applicable Manufacturer's Representative to validate standard manufacturer's warranty for each required product. Obtain written confirmation of receipt from each applicable Manufacturer's Representative.
3. Provide Contracting Agency one copy of submitted warranty documentation and written confirmation of receipt for each applicable Manufacturer's Representative. This information may be included within the Operations and Maintenance (IO&M) Manuals as determined by the Contracting Agency.
4. Provide statement of Contractor's warranty of workmanship, labor, and materials, as described under Article 1.12 Warranty below.

B. Record Documentation:

1. General: As the Work progresses, neatly annotate a designated and otherwise unused set of Divisions 20, 21, 22, 23, 25 Contract Drawings to show the actual locations and routing of Divisions 20, 21, 22, 23, 25 Work and the terminal connection points to related Work. As a minimum, include the following:
 - a. Annotate record drawings to incorporate each applicable addendum.
 - b. Annotate record drawings as directed by each applicable Request for Information (RFI) and accepted Change Order Proposal.
 - c. Modify record drawings to show actual equipment sizes and locations and pipe and duct routing. Revise pipe and duct sizes as appropriate.
 - d. Provide dimensioned locations for permanently concealed piping and ductwork (i.e. piping cast in concrete or buried underground/underslab).
 - e. Show the actual locations of system isolation valves, especially valves which are concealed above ceilings and behind access panels.
2. Preparation:
 - a. Neatly annotate record drawings to provide clear interpretation to support electronic drafting by a third party.
 - b. Tape electronic sketches from addendums and/or RFIs directly to the record drawings as overlays.
 - c. Annotate the record drawings in colored pencil using the same symbols and abbreviations as indicated in the Divisions 20, 21, 22, 23, 25 legends and schedules of the Contract Drawings.
 - 1). Red to add information.
 - 2). Green to delete information.
 - 3). Blue to provide additional clarifying information which is not to be drafted.
 - d. After submittal to the Contracting Agency, provide additional clarification, information or rework as necessary to support the accurate interpretation and electronic drafting of the record drawings.
3. Submittals:

SECTION 200000 – MECHANICAL GENERAL REQUIREMENTS

- a. Provide complete record drawings for concealed areas (i.e. above lay-in and hard ceilings and inside walls) to the Contracting Agency prior to concealment.
- b. Provide the remaining portion of the record drawings for exposed areas to the Contracting Agency prior to the final completion of the project.

1.7 MAINTENANCE MATERIAL SUBMITTALS

A. Spare Parts:

1. Furnish spare parts for systems and equipment as listed in applicable sections of Divisions 20, 21, 22, 23, 25.
2. Clearly label each part with name, manufacturer's part number, system and/or equipment where used and location.
3. Deliver parts to location and person designated by the Contracting Agency, in durable storage boxes.
4. Group cartons containing smaller items by system or application and deliver in an appropriate number of storage boxes.

B. Extra Stock Materials:

1. Furnish extra stock as listed in applicable sections of Divisions 20, 21, 22, 23, 25.
2. Clearly label with name, manufacturer's part number, system and/or equipment where used and location.
3. Deliver to location and person designated by the Contracting Agency, in durable storage boxes.

C. Tools: Provide three sets of special tools and testing and monitoring equipment as listed in applicable sections of Divisions 20, 21, 22, 23, 25.

1.8 QUALITY ASSURANCE

A. Qualifications:

1. Manufacturers: Companies specializing in manufacturing the Products specified in the Divisions 20, 21, 22, 23, 25 sections with minimum 3 years documented experience.
2. Fabricators: Companies specializing in fabricating the Products specified in the Divisions 20, 21, 22, 23, 25 sections with minimum 3 years documented experience.
3. Installers: Perform the Work using qualified workmen that are experienced and usually employed in the trade.
4. Testing Agencies: Products requiring electrical connection shall be listed and classified by Underwriters Laboratories Inc., as suitable for the purpose specified and as indicated.

B. Product Testing and Certification:

1. Nationally Recognized Testing Laboratory (NRTL) Labeling: Electrical equipment and conductors shall be "Approved," "Certified," "Identified," or "Listed" and "Labeled" to establish that the electrical equipment is safe, free of electrical shock and fire hazard, and suitable for the purpose for which it is intended to be used. The manufacturer shall have the specific authorization of one of the Occupational Safety and Health Administration (OSHA)

SECTION 200000 – MECHANICAL GENERAL REQUIREMENTS

- approved Nationally Recognized Testing Laboratories (NRTLs) in accordance with the applicable national standards to label the equipment as suitable.
2. Where the words Listed, UL Listed, UL Labeled, Underwriters Laboratories, Inc., UL, or variations of this terminology, appear under this Division of the Specifications or the associated drawings, it is understood that a comparable testing agency as defined by NRTL above is acceptable.
 3. Such testing and certification is generally applicable to products within the following categories:
 - a. Life safety and fire suppression.
 - b. Fuel burning equipment, except certain classes of power or industrial equipment for which other recognized certification applies as well.
 - c. Factory fabricated and wired electrical control panels and packaged equipment with factory installed electrical controls or panels.
 - d. Components for life safety systems, fuel systems and medical gas systems.
 4. The listing under Paragraph '3' above is provided for illustration of requirements and is not exclusive. Provide products that have been tested and listed for the intended application when such products are available unless the Contracting Agency has provided written exemption on an itemized basis.
 5. Provide electrical products listed and labeled by UL, FM, ETL or other approved NRTL. If listing and labeling is not available, stamp the submittal for these products by an Alaska Registered Professional Engineer approved by the Authority Having Jurisdiction, at no additional cost.
 6. Where interpretation is required, the Contracting Agency will provide direction and will be the sole judge in cases of compliance with this subsection.

1.9 DELIVERY, STORAGE AND HANDLING

A. Delivery and Acceptance Requirements:

1. Verify products are new and delivered in original factory packaging/crating and are free from damage and corrosion.
2. Replace products delivered to job site that does not comply with above requirements at no expense to Owner.
3. Remove damaged, or otherwise unacceptable, products from the project site when directed by the Contracting Agency.

B. Storage and Handling Requirements:

1. Store products in covered storage area protected from the elements, outside the general construction area until installed. Maintain ambient conditions required by manufacturer of each product.
2. Store products in original factory packaging until actual installation.
3. Handle items carefully to avoid breaking, chipping, denting, scratching, or other damage.
4. Replace damaged items with same item in new condition.

1.10 WARRANTY

- A. See Division 1 for general warranty requirements.

SECTION 200000 – MECHANICAL GENERAL REQUIREMENTS

- B. Warranty workmanship, labor, and materials for a period of one year from the date of final acceptance, without limitation, except where longer warranty periods are specified in a specific Section under this Division, or in the General Conditions of the Contract. Promptly coordinate and perform Warranty work at the Contractor's sole expense.
- C. Submit necessary documentation to each appropriate Manufacturer's Representative to validate manufacturer's warranty.
- D. Provide one copy of warranty documentation and confirmation receipt from the Manufacturer's Representative.

PART 2 - PRODUCTS - NOT USED

PART 3 - EXECUTION

3.1 PREPARATION

- A. Protection of In-Place Conditions:
 - 1. Cover and protect open ends and individual components of the ventilation and piping systems during construction when dust, dirt, debris, overspray, or other potential construction contaminates could enter the air distribution system or elements (ducts, fans, VAV boxes, silencers, etc.).
 - 2. Provide temporary construction filters over return airshaft openings and at air handling unit return air dampers.
- B. Demolition/Removal:
 - 1. Examination:
 - a. Drawings involving existing conditions are based on building record drawings and limited field observation.
 - b. Conduct a site inspection prior to submission of Bid to become thoroughly familiar with the Scope of Work.
 - c. Report discrepancies to the Contracting Agency before disturbing existing installation.
 - d. Verify field measurements, locations, sizes, and routing arrangements and site conditions.
 - e. Commencement of demolition implies Contractor accepts existing conditions.
 - 2. Preparation:
 - a. In buildings that will remain occupied during construction, coordinate with the Contracting Agency in advance before scheduling disruption of services.
 - b. This facility will remain occupied during construction. Coordinate with the Contracting Agency in advance before scheduling disruption of services.
 - c. Accommodate the Contracting Agency's normal business schedule to the maximum extent possible.
 - d. Provide temporary mechanical systems to maintain existing systems in service during construction. Submit plan for providing temporary services for approval.
 - e. Cover and protect open ends and individual components of the ventilation and piping systems during construction when dust, dirt, debris, overspray, or other

SECTION 200000 – MECHANICAL GENERAL REQUIREMENTS

potential construction contaminates could enter the air distribution system or elements (ducts, fans, VAV boxes, silencers, etc.).

- f. Provide temporary construction filters over return air openings and at air handling unit return air dampers.
 - g. When work must be performed on operating equipment or systems, use personnel experienced in the operation of the specific equipment affected.
 - h. Submit work plan and schedule for approval prior to beginning work.
 - i. Notify the Contracting Agency and the Fire Department Agencies at least 24 hours before partially or completely disabling Fire Suppression, Alarm, or Notification Systems.
 - j. Notify the Hospital at least 24 hours before beginning welding or other 'hot' work.
3. Execution:
- a. Remove, relocate, and extend existing installations to accommodate new construction as shown and as required for phasing or final systems operations.
 - b. Disconnect and remove abandoned fixtures, terminal units and other products. Remove abandoned controls and associated wiring to source of signal and supply.
 - c. Remove abandoned piping and ductwork back to source of supply or other point as shown, and cap tight to accept normal system test pressures.
 - d. Remove exposed abandoned or indicated for demolition controls, equipment, pipes and ducts, including abandoned items above ceiling finishes. Cut concealed pipes and ducts flush with walls and floors. Remove brackets, stems, hangers and other accessories. Fill and repair surfaces to match surrounding finish work.
 - e. Repair damaged surfaces, insulation, ceiling tiles, and fireproofing. Plug, patch, repair holes, and surfaces. Repair assemblies to match existing fire, temperature, and/or smoke ratings. Refinish surface to match surrounding finish work.
 - f. Seal room penetrations to maintain pressure relationships to adjacent spaces.
 - g. Maintain access to existing mechanical and electrical installations that remain active. Modify installation or provide access panels as appropriate; coordinate with the Contracting Agency.
 - h. Turn salvaged items over to the Contracting Agency as noted on the Drawings. Dispose of items that the Contracting Agency does not desire to retain at a legal disposal site.
 - i. Recover refrigerant charge from existing units to be demolished in accordance with EPA section 608 of the Clean Air Act of 1990. Remove recovered refrigerant from the premises.

3.2 INSTALLATION

A. Special Techniques:

1. Provide temporary heating to maintain the building at 65 degrees F.
2. Provide temporary ventilation with filtration during construction.

B. Interface with Other Work:

1. Electrical Work:
 - a. Coordinate with Division 26 [16].
 - b. See also specification section 200513 - Common Motor Requirements.

SECTION 200000 – MECHANICAL GENERAL REQUIREMENTS

- c. Suggested Coordination Schedule: The Contractor is responsible to provide heating, ventilating, and plumbing equipment motors and controls, including fire suppression controls. Unless otherwise indicated on the Drawings, it is recommended that motors and controls be furnished, set in place, and wired in accordance with the following schedule. “CC” applies to either a Control subcontractor working as a sub to the General Contractor or to the Divisions 20, 21, 22, 23, 25 Mechanical subcontractor. Coordinate work between subcontractors.

MC - Divisions 20, 21, 22, 23, 25-Mechanical CC - Divisions 20, 21, 22, 23, 25-Controls EC - Divisions 26, 27 and 28-Electrical	Furnished By	Set in Place By	Power By	Control By
Equipment Motors	MC	MC	EC	CC
*Magnetic motor starters:				
Automatic controlled, w/ or w/o HOA switches	EC	EC	EC	CC
Automatic controlled, w/ or w/o HOA switches, and that are furnished as part of factory wired equipment	MC	MC	EC	MC
*Manual Motor Starters:				
Manually controlled	EC	EC	EC	EC
Manually controlled, and that are furnished as part of factory wired equipment	MC	MC	EC	MC
Combination disconnect and motor starter	EC	EC	EC	CC
Motor Control Centers	EC	EC	EC	CC
Variable Speed Drives	MC	EC	EC	CC
Push-button stations, pilot lights, contactors, multi-speed switches	EC	EC	EC	EC
Disconnect switches, thermal overload switches, manual operating switches	EC	EC	EC	--
Multi-speed switches furnished as part of factory wired equipment	MC	MC	EC	MC
Temperature control relays, transformers, electric thermostats, time clocks, etc., that are not part of factory furnished equipment	CC	CC	CC	CC
Remote bulb thermostats, motor valves, controls, which are an integral part of factory furnished mechanical equipment.	MC	MC	EC	MC
Fire sprinkler suppression controls	MC	MC	EC	MC
Duct smoke detectors, including relays for fan shutdown	MC	MC	EC	EC
Fire/Smoke Dampers	MC	MC	EC	EC

SECTION 200000 – MECHANICAL GENERAL REQUIREMENTS

MC - Divisions 20, 21, 22, 23, 25-Mechanical CC - Divisions 20, 21, 22, 23, 25-Controls EC - Divisions 26, 27 and 28-Electrical	Furnished By	Set in Place By	Power By	Control By
Control Systems	CC	CC	CC	CC
Damper & Valve Actuators (120 v)	CC	CC	EC	CC
Damper & Valve Actuators (24 v)	CC	CC	CC	CC
Master Building Power quality monitors (loss/reversal)	EC	EC	EC	CC
Boiler and water heater controls, boiler burner control panels, internally wired	MC	MC	EC	MC
Electric Generator(s)				
Genset(s)	EC	EC	EC	EC
Fuel Lines	MC	MC	--	--
Day Tank (if separately furnished)	MC	MC	EC	MC
Silencer	EC	MC		

* Provide starters in accordance with the Electrical Division of these Specifications. Note that a thermal overload relay in each phase is required for each starter (packaged equipment included).

2. Coordination with Room Numbering:
 - a. Certain systems provided under this Division rely on identification systems that are based on room names or numbers.
 - b. The numbering scheme indicated in this Project Manual is based on room numbers assigned during the design process.
 - c. The Contracting Agency reserves the right to change the numbers prior to Substantial Completion, and the final names and numbers will not necessarily match those found in the Project Manual.
 - d. Obtain from The Contracting Agency the final room numbers prior to commencing the numbering of Divisions 20, 21, 22, 23, 25 systems.
 - e. Tag and label system equipment and devices in accordance with the final numbering scheme at no additional cost.

3.3 REPAIR/RESTORATION

- A. Touch-up, repair or replace product components broken during installation or startup with new replacement parts supplied by the product manufacturer.
- B. Substitute replacement parts from other manufacturers are not acceptable.
- C. Clean and repair existing identification tags/labels, hangers, supports, insulation, materials, instrumentation, and equipment that remain or are to be reused or are affected by this work. Materials and equipment which require major repair may be replaced at the Contractor's option.

SECTION 200000 – MECHANICAL GENERAL REQUIREMENTS

- D. Plug, patch and repair surfaces, adjacent construction, and finishes damaged during demolition and new work. Restore to original condition or better including fire, smoke or temperature ratings or listings. Retexture surfaces to match surrounding surfaces. Repaint affected surfaces, with extent of paint to include adjacent surfaces to next wall or other clean break to avoid mismatched finish. Replace cracked or damaged ceiling tiles. Repair fire proofing, assembly fire ratings, and construction resistant to the passage of smoke.

3.4 SITE QUALITY CONTROL

A. Site Tests and Inspections:

1. The Contracting Agency may inspect and approve sample installation of systems and equipment prior to general installation of units.
2. Schedule, obtain, and pay for fees and/or services required by the local Authorities Having Jurisdiction and by these specifications, to test the mechanical systems.
3. Notify the Contracting Agency a minimum of 24 hours in advance of tests. Certify in writing that specified tests have been made in accordance with the specifications.
4. Immediately correct deficiencies that are discovered during the tests and repeat tests until system is approved. Do not cover or conceal piping, equipment or other portions of the mechanical installations until satisfactory tests are made and approved.
5. Under the direction of the Contractor and in the presence of the Contracting Agency, place the entire mechanical installation and/or any portion thereof in operation to demonstrate satisfactory operation.
6. Arrange for the Contracting Agency to witness tests. The Contracting Agency may waive witnessing any specific test at its discretion.

B. Non-Conforming Work:

1. Expediently remove and provide new for work not conforming to the Project Manual upon discovery; including warranty and discovery periods.
2. Warranty period shall start over for replaced equipment and installation from the date of accepted by the Contracting Agency.

C. Manufacturer Services:

1. Authorized manufacturer's representative shall be on-site for testing, start-up, functional check-out, and commissioning of equipment and systems.
2. Procurement, installation, start-up, and warranty services to be provided by manufacturer's authorized representative and service company.
3. Equipment, devices, hardware, and software to be approved for application, and of current production. Original manufacturer's parts, hardware, software, and support to be available for ten years after installation.

3.5 CLEANING

- A. Upon completion of installation and prior to initial operation, remove debris, and clean and wipe down equipment, piping, ductwork and floor to eliminate dust and dirt.

SECTION 200000 – MECHANICAL GENERAL REQUIREMENTS

3.6 CLOSEOUT ACTIVITIES

- A. Demonstration: Provide demonstration, conducted by authorized factory start-up personnel, to the Contracting Agencies authorized personnel as listed in each individual specification section.
- B. Training: In addition to training specified in each individual specification section, provide 8 additional hours of operational instruction conducted by qualified personnel, covering any of the mechanical systems and installation requested by the Contracting Agency to its authorized maintenance personnel.

3.7 PROTECTION

- A. Provide finished products with protective covers during balance of construction.
- B. Provide open duct ends, grilles and diffusers with protective covers during balance of construction.
- C. Provide open pipe ends with protective caps during balance of construction.

END OF SECTION 200000

SECTION 200000 – MECHANICAL GENERAL REQUIREMENTS

THIS PAGE INTENTIONALLY LEFT BLANK

SECTION 200513 – COMMON MOTOR REQUIREMENTS

PART 1 - GENERAL

1.1 SUMMARY

- A. Section includes general requirements, products and methods of execution relating to electric motors in general and shall apply to motors furnished as integral parts of equipment specified in this and other Divisions.
- B. Related Sections:
 - 1. 200000 - Mechanical General Requirements
 - 2. 232123 - Hydronic Pumps
 - 3. 236400 - Packaged Water Chillers
 - 4. 238200 - Terminal Heating and Cooling Units
 - 5. 254000 - Variable Speed Drives

1.2 REFERENCES

- A. Codes and Standards:
 - 1. See section 200000 - Mechanical General Requirements.
 - 2. National Electrical Manufacturers Association, NEMA, Standards Publication Motors and Generators, MG-1.

1.3 SYSTEM DESCRIPTION

- A. Performance Requirements: Provide product performance characteristics as specified or scheduled on drawings.

1.4 PRE-INSTALLATION MEETINGS

- A. See section 200000 - Mechanical General Requirements.

1.5 SUBMITTALS

- A. See section 200000 - Mechanical General Requirements for general submittal requirements for the items listed below, supplemented with the additional requirements listed.
- B. Product Data:
 - 1. Provide a tabular listing of motors including the following information: Tag (from drawings), location, function, actual nameplate FLA, fuse size used, overload relay used, and overload setting.
 - 2. Make copy of list available during Substantial Completion observation by the Contracting Agency. Include list in Operations and Maintenance Manuals.

SECTION 200513 – COMMON MOTOR REQUIREMENTS

1.6 CLOSEOUT SUBMITTALS

- A. See section 200000 - Mechanical General Requirements.

1.7 MAINTENANCE MATERIAL SUBMITTALS

- A. See section 200000 - Mechanical General Requirements.

1.8 QUALITY ASSURANCE

- A. See section 200000 - Mechanical General Requirements.
- B. Certifications: Motors shall conform to governing NEMA Standards and ASA Form C-50 for rotating machinery.

1.9 DELIVERY, STORAGE AND HANDLING

- A. See section 200000 - Mechanical General Requirements.

1.10 WARRANTY

- A. Manufacturer Warranty: See section 200000 - Mechanical General Requirements, for general mechanical warranty requirements.

PART 2 - PRODUCTS

2.1 MOTORS IN ELECTRICAL CLASSIFIED LOCATIONS

- A. Motors used in environments indicated to be NEC Class I, Division I shall be built and labeled as explosion-proof for the Group and autoignition temperature, NEC T-code.
- B. Motors used in environments indicated to be NEC Class I, Division II:
 - 1. Listed for Class I Division I environments.
 - 2. Listed for Class I Division II environments.
 - 3. Does not have arc-producing brushes or switching mechanisms which could act as ignition sources.
 - 4. Motors that include a space heater, its surface temperature may not exceed 80% of the autoignition temperature of the hazard.

2.2 SUPPLY VOLTAGE

- A. Supply voltage shall be determined from the electrical plans where nominal utility voltage will be indicated.

SECTION 200513 – COMMON MOTOR REQUIREMENTS

- B. Motor voltage shall be stamped on the nameplate and relate to the nominal voltage as follows:

THREE PHASE MOTORS	
Nominal Volts	Motor Ratings
208 volts	200V, 208V, or 208/220V
240 volts	220V or 208/220V
480 volts	460V
SINGLE PHASE MOTORS	
Nominal Volts	Motor Ratings
120 volts	115V or 115/230V
240 volts	230V or 115/230V
208 volts	200V or 208V

Note: Provide nameplate indicating that voltage for a motor operating at 208 VAC is suitable.

- C. Voltage variation: Motors shall be designed to operate within the parameters of these requirements at rated load and with a voltage variation from the name plate voltage of plus or minus ten percent.
- D. Motors shall operate successfully at rated load and at rated voltage with a maximum frequency variation of five percent above or below rated frequency.
- E. Motors shall operate successfully at rated load with a combined maximum variation in the voltage and frequency of five percent above or below rated voltage and rated frequency.
- F. Motors that operate with Variable Speed Drive (VSD) controllers shall be suitable for the application.
1. Motors operated using PWM type VSDs: Conform to NEMA MG 1 Part 31 requirements.
 2. Motors operated using six-step type VSDs: Conform to NEMA MG 1 Part 30 or Part 31 requirements.

2.3 LOCKED ROTOR CURRENT

- A. No motor above 15 HP shall have a locked rotor current in excess of NEMA code letter “G”. Smaller motors may have a higher locked rotor rating, but in no case exceeding the recommended NEMA rating as related to motor size.

SECTION 200513 – COMMON MOTOR REQUIREMENTS

2.4 MOTOR INSULATION

- A. Unless otherwise specified, motor insulation shall be NEMA Class “B” (or better). Based on 40 degrees C. maximum ambient, and 90 degrees C. maximum rise, total maximum operating temperature shall not exceed 130 degrees C.

2.5 MOTOR LOADING

- A. No motors shall be subjected to loads exceeding the motor nameplate rating, under any normal operating condition.

2.6 MOTOR RATING

- A. Motors are sized in conformity with the manufacturer’s published information and shall not be interpreted as the final requirement. Check each motor for adequacy in relation to the specific application.
- B. Motors indicated as being connected to variable speed drives (VSD) shall be rated for VSD service.

2.7 HIGH EFFICIENCY AC MOTORS

- A. Furnished high efficiency electric motors for equipment that:
 - 1. Require a three horsepower or larger drive motor.
 - 2. Have duty cycles classified as continuous.
- B. Efficiency of the motors shall be determined by NEMA Standard MG 1 - 12.536 and shall have efficiencies equal to or better than:

Motor Size	Nominal Efficiency
Through 3 HP	89 percent
Over 3 HP through 10 HP	91 percent
Over 10 HP through 30 HP	93 percent
Over 30 HP through 60 HP	94 percent
Over 60 HP through 100 HP	95 percent
Over 100 HP	95 percent

2.8 MOTOR HOUSING FEATURES

- A. Open drip-proof, totally enclosed fan cooled (TEFC), or explosion-proof, as appropriate for the use intended and the environment where installed, or as noted. Provide totally enclosed fan cooled motors for equipment below grade, located outdoors, or operating in damp or dust-laden

SECTION 200513 – COMMON MOTOR REQUIREMENTS

locations. Provide a continuous moisture drain that is screened against insect entry for totally enclosed motors.

- B. Oversized external conduit boxes at least one size larger than NEMA standard.

2.9 SHAFT GROUNDING RINGS

- A. Motors operated on variable frequency drives shall be equipped with a maintenance-free, conductive microfiber shaft grounding ring (SGR) to meet NEMA MG-1, 3.4.4.4.3 requirements, with a minimum of two rows of circumferential microfibers to discharge damaging shaft voltages away from the bearings to ground. SGR's Service Life: Designed to last for service life of motor. Provide AEGIS SGR Conductive MicroFiber Shaft Grounding Ring, or approved equal.
- B. Application Note: Motors up to 100 HP shall be provided with one shaft grounding ring installed on either the drive end or non-drive end. Motors over 100 HP shall be provided with an insulated bearing on the non-drive end and a shaft grounding ring on the drive end of the motor with the exception of line contact bearings in the drive end of the machine. In this case the line contact bearing shall be electrically insulated and the AEGIS Bearing Protection Ring installed on the opposite drive end of the motor. Grounding rings shall be provided and installed by the motor manufacturer or contractor and shall be installed in accordance with the shaft grounding ring manufacturer's recommendations.

2.10 HIGH FREQUENCY BONDING

- A. Motors operated on variable frequency drives shall be bonded from the motor foot to system ground with a high frequency ground strap made of flat braided, tinned copper with terminations to accommodate motor foot and system ground connection. Provide AEGIS HF Ground Straps, or equal.
- B. Application Note: High frequency grounding straps shall be used to ensure the proper grounding of inverter driven induction motor frames.

PART 3 - EXECUTION

3.1 PREPARATION

- A. Protection of In-Place Conditions: Cover motors to protect them from construction dirt and debris.

3.2 INSTALLATION

- A. Special Techniques:
 1. Installation of motors shall be as required by the driven equipment. Make sure motor design and characteristics are suitable for the application.
 2. Electrical connections for motors shall conform to NEC Articles 430 and 440 as applicable, and to any state and local code having jurisdiction.

SECTION 200513 – COMMON MOTOR REQUIREMENTS

3. Unless furnished as part of a complete package including disconnects and control, and/or motor fuse protection, protect motors by Bussmann Fusetron Dual-Element Time Delay fuses, or approved equal.
4. Megger motor windings prior to starting. Include log of megger readings in the Operations and Maintenance manuals.
5. Verify correct rotation of motors.
6. Comply with Article 460 of the National Electrical Code for installation of power factor correction capacitors.
7. Motor sizes shown on the Drawings are estimates based upon the mechanical design. Where motors actually furnished are of a different size than those shown, motor circuit components (starters, disconnects, overcurrent devices, and conductors) shall be revised to suit the motors actually furnished, without increase in the Contract amount. Similarly, motor overcurrent device sizes shown on the Drawings or specified are based upon estimated motor code letters, overcurrent device manufacturers' recommendations, and full-load currents from the NEC Tables. Where the motors actually furnished require different sizing, the sizes of the overcurrent devices shall be adjusted to conform to the NEC, without increase in the Contract amount.

3.3 SHAFT GROUNDING RINGS (MOTORS WITH VARIABLE FREQUENCY DRIVES)

- A. Shaft grounding rings (SGR) shall be factory installed inside the motors by the manufacturer wherever possible. SGRs may be field installed by installing contractor subject to Engineer's approval. Provide AEGIS SGR Colloidal Silver Shaft Coating, or approved equal, on shafts prior to rings installation, per SGR manufacturer's recommendations, after first cleaning shafts.
- B. Install and test SGRs in accordance with manufacturer's recommendations. Install the SGR so that the aluminum frame maintains an even clearance around the shaft. Conductive microfibers shall be in full circumferential contact with conductive metal surface of the shaft. Do not use thread lock to secure the mounting screws as it may compromise the conductive path to ground. If thread lock is required, use a small amount of EP2400 AEGIS Conductive Epoxy, or approved equal, to secure the screws in place.
- C. Shafts shall be clean and free of any coatings, paint, or other nonconductive material (clean to bare metal). Depending upon the condition of the shaft, it may require using emery cloth or Scotch-Brite. If the shaft is visibly clean, a non-petroleum based solvent may be used to remove any residue. Check the conductivity of the shaft using an ohm meter. Ohms test: Place the positive and negative meter leads on the shaft at a place where the microfibers will contact the shaft. Each motor will have a different reading but in general one should have a maximum reading of less than 2 ohms. If the reading is higher, clean the shaft again and retest.
- D. After motors with SGRs are fully installed in the field (in equipment, assemblies, or individually), for both factory installed SGRs and field installed SGRs, test for a conductive path to ground using an Ohm meter. Place one probe on metal frame of SGR and one probe on motor frame. Motor must be grounded to common earth ground with variable frequency drive according to applicable standards. Verify that SGR installations and test readings comply with SGR manufacturer's requirements.

SECTION 200513 – COMMON MOTOR REQUIREMENTS

3.4 HIGH FREQUENCY BONDING (MOTORS WITH VARIABLE FREQUENCY DRIVES)

- A. Motors operated on variable frequency drives shall be bonded from the motor foot to system ground with a high frequency ground strap made of flat braided, tinned copper with terminations to accommodate motor foot and system ground connection. Provide AEGIS HF Ground Straps, or approved equal. After motors with SGRs are fully installed in the field (in equipment, assemblies, or individually), for both factory installed SGRs and field installed SGRs, test for a conductive path to ground using an Ohm meter.

3.5 REPAIR/RESTORATION

- A. Repair any components broken during installation or startup with replacement parts supplied by the product manufacturer.
- B. Substitute replacement parts from other manufacturers are not acceptable.

END OF SECTION 200513

SECTION 200513 – COMMON MOTOR REQUIREMENTS

THIS PAGE INTENTIONALLY LEFT BLANK

SECTION 200529 – MECHANICAL HANGERS AND SUPPORTS

PART 1 - GENERAL

1.1 SUMMARY

A. Section Includes:

1. General hanger and support requirements for building service piping and mechanical equipment not required to be vibration and/or seismically controlled.
2. Penetrations, sleeves and seals.

B. Products Installed But Not Supplied Under this Section: Vibration Isolation and Seismic Control anchoring and support systems.

C. Related Sections:

1. 200000 - Mechanical General Requirements
2. 200513 - Common Motor Requirements
3. 200553 - Mechanical Identification
4. 200700 - Mechanical Insulation
5. 221100 - Domestic Water Piping and Specialties
6. 221300 - Sanitary Waste and Vent Piping and Specialties
7. 232113 - Hydronic Piping and Specialties
8. 232123 - Hydronic Pumps
9. 233100 - Ducts and Accessories
10. 233700 - Air Outlets and Inlets
11. 236400 - Packaged Water Chillers
12. 238200 - Terminal Heating and Cooling Units
13. 254000 - Variable Speed Drives

1.2 REFERENCES

A. Codes and Standards:

1. See section 200000 - Mechanical General Requirements.
2. MSS SP58-2018 Pipe Hangers and Supports - Materials, Design, Manufacture, Selection, Application and Installation.

B. Abbreviations, Acronyms and Definitions:

1. Refer to Division 01 for general abbreviations, acronyms, and definitions.
2. Refer to Section 200000 - Mechanical General Requirements for general mechanical related definitions.
3. Refer to Mechanical Drawings legend sheet for general mechanical related abbreviations.

1.3 DESCRIPTION

A. Design Requirements:

SECTION 200529 – MECHANICAL HANGERS AND SUPPORTS

1. Equipment and piping system support:
 - a. Select and apply pipe hangers and supports per MSS SP58 using stock or production parts whenever possible.
 - b. Design support spacing such that free span of piping does not exceed Code or MSS SP58 criteria (whichever is most restrictive).
 - c. Calculate required supporting force at each hanger location to confirm hanger type and hanger rod diameter selection.
 - d. Provide hangers such that equipment connection points do not carry connected piping load.
2. Vibration and seismic restraint systems: Coordinate the requirements of this section with Section 200000 - Mechanical General Requirements.

B. Performance Requirements:

1. Provide hangers and supports which allow for the free expansion and contraction of system piping without transferring tensile and compressive stresses to adjacent supports or connected equipment. Provide additional expansion loops, pipe anchor and pipe guide assemblies as required.
2. Coordinate hanger and support anchor locations and embedment depth requirements with structural.
3. Provide flexible connectors for piping systems which pass through seismic building joints. Design flexible connects for design building offset plus 100 percent safety factor.
4. Support fire suppression system piping and equipment accordance with the provisions of Section 21 0000 – Mechanical General Requirements.
5. Support plumbing piping in accordance with this section and Uniform Plumbing Code requirements; whichever is more restrictive. In case of conflicts, follow UPC guidance.
6. Support ductwork in accordance with Section 23 3100 - Ducts and Accessories.

1.4 PRE-INSTALLATION MEETINGS

- A. See section 200000 - Mechanical General Requirements.

1.5 SUBMITTALS

- A. See Section 200000 - Mechanical General Requirements for general submittal requirements for the items listed below, supplemented with the additional requirements listed.
- B. Product Data:
 1. Provide manufacturers catalog data, including load capacity, embedment depth.
 2. Manufacturer's Installation Instructions: Indicate special procedures and assembly of components.
- C. Shop Drawings:
 1. Provide shop drawings for housekeeping pads and roof curbs (with dimensioned penetrations) and field fabricated support systems.

SECTION 200529 – MECHANICAL HANGERS AND SUPPORTS

2. Provide shop drawings to show system layout with location and detail of hangers, anchors, dimensioned expansion loops and guides.

1.6 CLOSEOUT SUBMITTALS

A. Operation and Maintenance (IO&M) Manuals:

1. Refer to Section 200000 - Mechanical General Requirements, for IO&M Manual formatting requirements and number of copies required.
2. Include the following:
 - a. Copies of approved submittal information.
 - b. Manufacturer's installation, operating and maintenance/repair instructions, parts listings, and spare parts list for each product. Clearly annotate the manual to indicate applicable information for the specific equipment model(s) installed.

B. Warranty Documentation: Provide standard manufacturer's warranty and submit documentation in accordance with Section 200000.

C. Record Documentation:

1. Indicate installed locations of hangers, supports and expansion control assemblies on record drawings on associated piping record drawings.
2. Provide Operating and Maintenance Data (installation and adjustment instructions) for non-commodity products.

1.7 MAINTENANCE MATERIAL SUBMITTALS

- A. See section 200000 - Mechanical General Requirements.

1.8 QUALITY ASSURANCE

- A. See section 200000 - Mechanical General Requirements.
- B. Provide piping and support systems designed and manufactured per MSS SP58.

1.9 DELIVERY, STORAGE, AND HANDLING

- A. See section 200000 - Mechanical General Requirements.

1.10 WARRANTY

- A. See section 200000 - Mechanical General Requirements.

SECTION 200529 – MECHANICAL HANGERS AND SUPPORTS

PART 2 - PRODUCTS

2.1 PIPE HANGERS AND SUPPORTS

A. General:

1. Piping and support systems shall be malleable iron, steel or copper.
2. Ferrous hangers and supports installed outdoors or in unheated spaces shall be hot dipped galvanized.
3. Select and apply pipe hangers and supports per MSS SP58.
 - a. Use stock or production parts whenever possible.
 - b. Calculate weight balance to determine the required supporting force at each hanger location and to eliminate pipe weight load at each equipment connection.
4. Fabricate and install pipe hangers and supports per MSS SP58 recommended practices.
5. Hangers shall be designed to securely lock using a mechanical fastener. Hangers and supports using gravity type locking are not acceptable. For example, adjustable swivel ring Type 6 is not allowed.
6. Pre-engineered support systems such as Unistrut, Super-Strut, B-Line and K-Line may be used in accordance with manufacturers load limits.
7. Manufacturers: Grinnell, M-CO Michigan Hanger Company, Kin Line.

B. Plumbing Piping:

1. Conform to the Uniform Plumbing Code requirements.
2. Hangers for Pipe Sizes 1/2 to 1-1/2 inch: Adjustable swivel ring; split ring.
3. Hangers for DWV and Cold Pipe Sizes two inch and over: Carbon steel, adjustable, clevis.
4. Hangers for Hot Pipe sizes two to four inch: Carbon steel, adjustable, clevis.
5. Hangers for Hot Pipe Sizes six inches and over: Adjustable steel yoke, cast iron roll, double hanger.
6. Multiple or Trapeze Hangers under six inches: Steel channels with welded spacers and hanger rods.
7. Multiple or Trapeze Hangers for Hot Pipe Sizes six inches and over: Steel channels with welded spacers and hanger rods, cast iron roll.
8. Wall Supports: Welded steel bracket and wrought steel clamp.
9. Wall Support for Hot Pipe Sizes six inches and over: Welded steel bracket and wrought steel clamp with adjustable steel yoke and cast iron roll.
10. Floor Support for Cold Pipe: Cast iron adjustable pipe saddle, lock nut, nipple, floor flange, and steel support.
11. Floor Support for Hot Pipe Sizes up to four inches: Cast iron adjustable pipe saddle, lock nut, nipple, floor flange, and steel support.
12. Floor Support for Hot Pipe Sizes six inches and over: Adjustable cast iron roll and stand, steel screws, and steel support.
13. Vertical Support: Steel riser clamp.
14. Provide copper plated hangers and supports for copper piping. Copper Pipe Support: Carbon steel ring, adjustable, copper plated.

C. Hydronic Piping:

1. Conform to ASME B31.9 and the International Mechanical Code.

SECTION 200529 – MECHANICAL HANGERS AND SUPPORTS

2. Hangers for Pipe Sizes 1/2 to 1-1/2 inch: Adjustable swivel ring; split ring.
3. Hangers for Cold Pipe Sizes two inches and over: Carbon steel, adjustable, clevis.
4. Hangers for Hot Pipe sizes two to four inch: Carbon steel, adjustable, clevis.
5. Hangers for Hot Pipe sizes six inches and over: Adjustable steel yoke, cast iron roll, double hanger.
6. Multiple or Trapeze Hangers: Steel channels with welded spacers and hanger rods.
7. Multiple or Trapeze Hangers for Hot Pipe Sizes six inches and over: Steel channels with welded spacers and hanger rods, cast iron roll.
8. Wall Support: Welded steel bracket and wrought steel clamp.
9. Wall Support for Hot Pipe Sizes six inches and over: Welded steel bracket and wrought steel clamp with adjustable steel yoke and cast iron roll.
10. Vertical Support: Steel riser clamp.
11. Floor Support for Cold Pipe: Cast iron adjustable pipe saddle, lock nut, nipple, floor flange, and steel support.
12. Floor Support for Hot Pipe Sizes up to four inches: Cast iron adjustable pipe saddle, lock nut, nipple, floor flange, and steel support.
13. Floor Support for Hot Pipe Sizes six inches and over: Adjustable cast iron roll and stand, steel screws, and steel support.
14. Provide copper plated hangers and supports for copper piping. Copper Pipe Support: Carbon steel ring, adjustable, copper plated.

2.2 ACCESSORIES

- A. Hanger Rods: Mild steel, threaded both ends, threaded one end, or continuous threaded.
- B. Escutcheons: Nickel or chrome plate with screws or springs for holding plate in position.
- C. Pipe Protection Saddles: Shop fabricated, or purchase specially manufactured saddles specifically designed for the intended use. Provide saddles where roller type support is used, or where the pipe hanger is installed outside the insulation for protection of insulating jacket.
- D. Outdoor applications: Metal components shall be galvanized.

2.3 INSERTS

- A. Provide inserts to match the load bearing capacity of hangers scheduled in Part 3.
- B. Provide hooked rod to concrete reinforcement section for inserts carrying pipe over four inches.
- C. Concrete deck inserts: Galvanized rod, steel plate, similar to Kin-Line figure 293.
- D. Screw insert for concrete: Malleable iron similar to Grinnell figure 152.

2.4 PRE-ENGINEERED SUPPORT SYSTEMS

- A. Manufacturers:
 1. Unistrut.

SECTION 200529 – MECHANICAL HANGERS AND SUPPORTS

2. Super-Strut.
3. B-Line.
4. K-Line.
5. Erico.

B. Materials:

1. Cold worked steel.
2. Type 304 stainless steel: Use for PVC, liquid-tight flex, or plastic-coated conduit installed to wood construction in outdoor, damp, corrosive or marine environments.

C. Finish:

1. Heated indoor areas: Pre-galvanized zinc coating.
2. Outdoor areas: Hot dipped galvanized finish. In addition, coat hot dipped galvanized finish channel field cuts with zinc rich paint provide by the support system manufacturer.
3. Painted areas: Paintable galvanizing or phosphatized and primed.
4. Surface metal raceways: U.L. Listed epoxy coating.

D. Channel:

1. Standard Size: 1-5/8 inch x 1-5/8 inch. Gauge thickness as required for attached load.
2. Standard Hole Pattern: Slotted. Provide solid channel in exposed public areas.

E. Nuts and Hardware:

1. Channel nuts: Hardened steel (ASTM-A675 and ASTM A36).
2. Bolts, screws and nuts: Hardened steel (ASTM-A307, ASTM A563 and SAE J429).
3. Finish: Electroplated zinc.

F. Fittings: Plate steel (ASTM A635). Epoxy or electroplated zinc coating.

G. Mechanical Accessories: Provide accessories from the support system manufacturer designed for the specific equipment to be supported to include but not limited to:

1. Splice and gusset plates.
2. Corner angles.
3. Specialized support brackets.
4. Beam clamps with restraints.
5. Column supports.
6. Strut pipe clamps.
7. Straps.
8. Brackets.

2.5 SLEEVES, ACOUSTICAL SEALS AND FIRE-STOPPING

A. See Part 3 - PENETRATIONS.

B. Sleeves for pipes through fire rated and fire resistive floors and walls, and fire proofing: UL listed prefabricated fire rated sleeves and seals.

SECTION 200529 – MECHANICAL HANGERS AND SUPPORTS

2.6 WALL/FLOOR PENETRATION WATER SEALS

- A. Mechanical seal consisting of interlocking synthetic rubber links shaped to continuously fill the annular space between the pipe and the wall opening.
- B. EPDM seals.
- C. 316 Stainless steel bolts and nuts.
- D. Hot-dipped galvanized or coated sleeve with full water stop flange with continuous weld on both sides.
- E. Manufacturer: Metraflex, Thunderline, Crouse-Hinds, or approved equal.

PART 3 - EXECUTION

3.1 INSTALLERS

- A. Installer: Perform work by experienced personnel previously engaged in construction and under the supervision of a qualified installation supervisor.

3.2 PREPARATION

- A. Prior to installation, prepare detailed shop drawings of the planned installation of hanger and support products specified by this section. Coordinate the location, type and size of hangers and supports, housekeeping pads (thickness/perimeter overhang dimensions) and roof curbs with Architectural and Structural elements utilizing the shop drawing review process.
- B. Submit shop drawings required by this section coordinated with the seismic design and associated shop drawings.
- C. Do not install hangers and supports without approved shop drawings.

3.3 INSTALLATION

- A. Special Techniques:
 - 1. Install vibration isolators, seismic control and wind restraint systems in compliance with the manufacturer's written instructions and certified and approved application engineering installation drawings and details in accordance with Section 200000 – Mechanical General Requirements.
 - 2. Insert and Attachment Installation:
 - a. Inserts:
 - 1). Provide inserts or cast-in-place channels for placement in concrete formwork.
 - 2). Provide inserts for suspending hangers from reinforced concrete slabs and sides of reinforced concrete beams.
 - 3). Where concrete slabs form finished ceiling, locate inserts flush with slab surface.

SECTION 200529 – MECHANICAL HANGERS AND SUPPORTS

- 4). Use expansion type anchor bolts with pre-cast concrete including concrete masonry units within loading limits of the pre-cast material and anchor bolt manufacturer's recommendations.
 - 5). Where inserts are omitted, drill through concrete slab from below and provide through-bolt with recessed square steel plate and nut recessed into and grouted flush with slab.
 - 6). Plastic screw inserts and caulked lead inserts are prohibited, except for mounting instructions and control diagrams.
 - b. Attach mechanical equipment to structure as follows:
 - 1). Hollow masonry: Toggle bolts.
 - 2). Solid masonry and concrete: Preset inserts or expansion bolts.
 - 3). Structural steel: Beam clamps which engage both sides of structural member or have retaining clips or other approved means for positive engagement.
 - 4). Metal surfaces: Machine screws, bolts or welding.
 - 5). Wood construction: Wood or sheet metal screws.
 - 6). Do not use powder-actuated fasteners for anchorage in tension applications. Obtain written permission from the Owner prior to using any type of powder powered studs.
3. Pipe Hanger and Support Installation:
- a. Install hangers and supports in accordance with manufacturer's instructions, applicable Code requirements and approved shop drawings.
 - b. Support horizontal piping as scheduled.
 - c. Independently support piping at equipment, so that the equipment supports no weight.
 - d. Insulated piping shall have insulation saddles or 18 gauge steel insulation shields combined with sections of calcium silicate or cellular glass. Cold piping shall always be supported over the insulation and vapor barrier. Subject to approval, hot piping may be insulated around the supports.
 - e. Trapeze hangers shall be used when more than three pipes run parallel and at same elevation. Provide rollers for hot pipes. Design rods and cross members to support three times the weight of pipes and contents plus 250 pounds.
 - f. Install hangers to provide minimum 1/2-inch space between finished covering and adjacent work.
 - g. Place hangers within 12 inches of each horizontal elbow.
 - h. Use hangers with 1-1/2 inch minimum vertical adjustment.
 - i. Support horizontal cast iron pipe adjacent to each hub, with five feet maximum spacing between hangers.
 - j. Support vertical piping at every floor. Support vertical cast iron pipe at each floor at hub.
 - k. Support riser piping independently of connected horizontal piping.
 - l. Provide saddles where roller type support is used, or where the pipe hanger is installed outside insulation for protection of insulating jacket.
 - m. Piping requiring Vibration Isolation:
 - 1). Support main risers less than 20 feet in height only at mid-level, with riser guides at other levels.
 - 2). Do not support vibration isolated piping along with non-isolated piping on a common trapeze.
 - 3). Rigidly mount steel spring hanger boxes to the supporting structure. Do not locate in the middle of the hanger rod.

SECTION 200529 – MECHANICAL HANGERS AND SUPPORTS

- 4). Rigid pipe anchors are not permitted in vibration isolated piping circuits. When pipe anchors are required.
4. Equipment Bases and Support Installation:
 - a. For cast-in-place concrete requirements refer to Division 3 - Concrete.
5. Mechanical Equipment Installation:
 - a. Provide hardware and accessories necessary to mount fixtures and equipment. Adapt to field conditions.
 - b. Securely fasten fixtures and equipment to the building structure in accordance with the manufacturer's installation recommendations.
 - c. Provide fabricated steel supports frames and bases for equipment not directly mounted on floor. For belt driven equipment provide rigid structural base in common with motor to maintain belt tension.
 - d. Provide steel base plates for floor mounted fixtures and equipment to distribute the weight such that the floor load is not more than 100 PSF, unless special structural reinforcement is submitted for approval.
 - e. At wall attached fixtures and equipment weighing less than 50 pounds, provide backing plates at least 1/8 by 10 inch square sheet steel or two by 10 inch fire retardant treated wood securely built into the structural walls. Submit attachment details of heavier equipment for approval.
 - f. Painted fabricated steel support black in accordance with Division 9 - Finishes.
6. Penetrations:
 - a. Coordinate mechanical penetrations with architectural and structural construction details prior to installation. Set sleeves in position in concrete formwork. Provide reinforcement around sleeves as required.
 - b. Provide compatible materials, fasteners, adhesives, sealants, and other products required for proper installation.
 - c. Provide penetrations through roof, exterior walls and floors (See floor penetration seals) to be weather and watertight.
 - d. Fire-Stopping: Provide UL rated fire-stopping assemblies for rated roof, wall and floor penetrations in accordance with Division 7.
 - e. Pipe and Duct Sleeves/Framed Openings:
 - 1). Provide sleeves for pipe and round ducts less than 16 inches diameter passing through floors, walls, ceilings, or roofs. Fabricate sleeves in non-load bearing walls from 20 gauge galvanized sheet steel conforming to ASTM A924 / A924M. Fabricate sleeves in load-bearing walls from standard-weight galvanized steel pipe conforming to ASTM A53 / A53M. Provide 1 inch clearance between the pipe or duct and sleeve opening. Oversize sleeves for cold piping to allow continuous insulation through sleeve.
 - 2). Provide framed openings for round ducts 16 inch diameter and greater and rectangular ductwork passing through floors, walls, ceilings, or roofs. Provide structural steel members for framed openings conforming to ASTM A36 / A36M. Provide 1 inch clearance between the duct and framed opening.
 - 3). Provide closure collars not less than 4 inches wide on each side of duct wall or floor penetration where sleeves or framed openings are provided. Fabricate collars for round and rectangular ducts with a minimum dimension less than 16 inches from 20 gauge galvanized steel. Fabricate collars for round and

SECTION 200529 – MECHANICAL HANGERS AND SUPPORTS

- rectangular ducts with a minimum dimension of 16 inches or greater from 18 gauge galvanized steel.
- 4). Provide escutcheons for piping and conduit passing through walls, floors and ceilings in finished areas, below counters and inside closets and casework subject to view when doors are open. Size escutcheons to cover sleeves. Secure escutcheons in position.
- f. Acoustical Seals:
- 1). Monolithic sound walls (i.e. poured concrete or masonry): Provide wall sleeve with approximately one-inch annular space around pipe. Pack annular space with backer rod or acoustical filler as specified in Division 7. Allow a 1 inch recess at each end of sleeve. Caulk sleeve flush with flexible sealant or firestopping material as specified in Division 7.
 - 2). Where acoustical wall is a two component type, such as a staggered or double stud partition, treat each component as a separate wall. Pack and seal each half of penetration sleeve as previously specified, except that only the exposed end of each sleeve portion can be caulked with sealant or fire-stop. Provide adequate separation between each sleeve.
- g. Wall Penetration Seals:
- 1). Provide pre-engineered wall penetration water seal systems for exterior wall penetrations.
 - 2). Select appropriate wall penetration sealing systems based on pipe/conduit material and nominal pipe/conduit size in accordance with the manufacturer's selection charts.
 - 3). Install piping/conduit and sealing system prior to waterproofing the wall. Grout void between water seal and outside face of foundation wall to provide continuous bearing surface for waterproofing fabric.
- B. Interface with Other Work: Coordinate and sequence installation of hangers and supports with trades responsible for portions of this and other related sections of the Project Manual.

3.4 REPAIR/RESTORATION

- A. Repair any product components broken during installation or startup with replacement parts supplied by the product manufacturer.
- B. Substitute replacement parts from other manufacturers are not acceptable.

3.5 SITE QUALITY CONTROL

- A. Non-Conforming Work: Rework required as a result of failure to follow the manufacturer's written installation instructions or to properly coordinate with related Work shall be completed at no additional expense to the Owner.

3.6 CLEANING

- A. Waste Management: After construction is completed, clean and wipe down exposed surfaces.

SECTION 200529 – MECHANICAL HANGERS AND SUPPORTS

3.7 ATTACHMENTS

A. Tables:

1. Pipe Support: Provide pipe support spacing as indicated in the table below, except where spacing is more restrictive by Code.

PIPE SIZE (Inches)	HANGER SPACING MAX (Feet)			
	Steel		Copper	Polyethylene (1)
	Water Filled	Gas Filled		
1/2	7	9	5	
3/4	7	9	5	
1	7	9	6	
1-1/4	7	9	7	
1-1/2	9	12	8	4
2	10	13	8	4-1/2
2-1/2	11	14	9	
3	12	15	10	5
4	14	17	12	6
6	17	21	14	
8	19	24	16	

(Based on Table 4, MSS SP-58, except for PE piping)

(1)(Based on manufacturer's data)

END OF SECTION 200529

SECTION 200529 – MECHANICAL HANGERS AND SUPPORTS

THIS PAGE INTENTIONALLY LEFT BLANK

SECTION 200553 – MECHANICAL IDENTIFICATION

PART 1 - GENERAL

1.1 SUMMARY

A. Section includes:

1. Equipment Nameplates.
2. Valve Tags.
3. Valve and Equipment Directories.
4. Pipe Identification.
5. Ceiling Markers.

B. Related Sections:

1. 20 0000 - Mechanical General Requirements
2. 22 1100 - Domestic Water Piping and Specialties
3. 22 1300 - Sanitary Waste and Vent Piping and Specialties
4. 23 2113 - Hydronic Piping and Specialties
5. 23 2123 - Hydronic Pumps
6. 23 3100 - Ducts and Accessories
7. 23 6400 - Packaged Water Chillers
8. 23 8200 - Terminal Heating and Cooling Units
9. 25 4000 - Variable Speed Drives

1.2 REFERENCES

A. Codes and Standards:

1. See section 20 0000 - Mechanical General Requirements.
2. ANSI/ASME A13.1-2015 (American Society of Mechanical Engineers) - Scheme for the Identification of Piping Systems.
3. ANSI Z535.1-2017 - Safety Colors.

A. Abbreviations, Acronyms and Definitions:

1. Refer to Division 01 for general abbreviations, acronyms, and definitions.
2. Refer to Section 20 0000 - Mechanical General Requirements for general mechanical related definitions.
3. Refer to Mechanical Drawings legend sheet for general mechanical related abbreviations.

1.3 SYSTEM DESCRIPTION

A. Design Requirements:

1. Provide equipment nameplates, valve tags and labels for the mechanical systems provided under this contract.

SECTION 200553 – MECHANICAL IDENTIFICATION

2. Provide labels for piping. Paint exposed piping and pipe insulation in utility and mechanical rooms.

1.4 SUBMITTALS

- A. Refer to Section 20 0000 - Mechanical General Requirements for general submittal requirements for the items listed below, supplemented with the additional requirements listed.
- B. Product Data:
 1. Master Schedule of Equipment:
 - a. Submit master schedule of equipment, components, and systems that will be tagged and labeled for the project.
 - b. Include the proposed method of labeling to be implemented (nameplate, tag, label/marker, etc.), legend (“Domestic Cold Water,” “PMP-1,” etc.) and letter/background colors.
 - c. Match legend to Contract Document legend, abbreviations, and schedule symbols. Use standard mechanical identification products when available.
 2. Equipment Directories: Submit separate proposed “Equipment Directories” (subset of the master schedule) for each mechanical room that includes the equipment located within the applicable space. Include system name, fluid or medium type, and normal operating properties and ranges.
 3. Valve Directories: Submit separate proposed “Valve Directories” (subset of the master schedule) for each mechanical room that includes the valves located within the applicable space. Include valve designations, a brief description and normal position (open (NO), closed (NC), balanced to X GPM). For Example:

Valve Designator	Description	Normal Position
H-101	BLR-1 Supply Isolation	NO
H-102	BLR-1 Return Isolation	NO
H-103	BLR-1 Flow Balance	150 GPM
P-100	Domestic Water Service Isolation	NO
P-201	Supply Strainer Flush Valve	NC
ETC.		

- C. Installation, Operation and Maintenance (IO&M) Manuals:
 1. Provide completed, typed “Master Schedule of Equipment.”
 2. Provide completed, typed “Equipment Directories.”
 3. Provide completed, typed “Valve Directories” with balance valve settings obtained from the final balance report.

PART 2 - PRODUCTS

SECTION 200553 – MECHANICAL IDENTIFICATION

2.1 MANUFACTURERS

- A. Marking Services Incorporated (MSI).
- B. Seton Identification Products.
- C. Craftmark.
- D. Approved equal.

2.2 EQUIPMENT NAMEPLATES

- A. Plastic Engraved Equipment Nameplates:
 - 1. Minimum letter height: 3/4 inch.
 - 2. Tag size: Minimum 2 inches high, length to fit equipment tag lettering requirements. Provide uniform size for similar types of equipment.
 - 3. Plastic thickness: 1/16 inch minimum.
 - 4. Fastening method:
 - a. Mounting holes.
 - b. Adhesive backing may be provided for labeling equipment where drilling holes is not feasible, with the pre-approval of the Contracting Agency.
 - 5. Color coding: As designated by the Contracting Agency. If specific direction is not provided, select white letters on black background.
 - 6. Legend: As designated by the Contracting Agency. If specific direction not provided, match scheduled equipment symbols.

2.3 VALVE TAGS

- A. General:
 - 1. Small equipment, such as in-line pumps may be identified with tags in lieu of nameplates if inadequate room is available.
 - 2. Provide service indicator on top line of tag, using system abbreviations provided in Part 3 Pipe Identification Table.
 - 3. Provide valve number on bottom line of tag. Start valve numbering with “001” for each legend series/service indicator. Assign valve numbers in a logical sequence from the source (i.e. service water entry point, gas meter service isolation) or heat source (boiler or water heater supply) and continue numbering outward to the most remote terminal connection point.
- B. Plastic Engraved Tags:
 - 1. Round, 1-1/2 inches diameter, engraved plastic.
 - 2. Text stamped and filled black:
 - a. 1/4 inch service indicator on top.
 - b. 1/2 inch valve number below.

SECTION 200553 – MECHANICAL IDENTIFICATION

3. Beaded chain tag fasteners.
4. Provide tag color coding to match pipe marker coding or as designated by the Contracting Agency.

C. Brass Stamped Tags:

1. Round, 1-1/2 inches diameter, brass with smooth edges.
2. Text stamped and filled black:
 - a. 1/4 inch service indicator on top.
 - b. 1/2 inch valve number below.
3. Beaded chain tag fasteners.

2.4 VALVE AND EQUIPMENT DIRECTORIES

A. Equipment and Valve Directory Frame:

1. 8-1/2" x 11" aluminum frame with plastic lens.
2. Provide multiple frames as required.

2.5 PIPE IDENTIFICATION, MARKING

A. Identify both service and flow direction.

B. Colors and Lettering: Conform to ANSI/ASME A13.1; see tables under Article 3.2E below.

C. Plastic Pipe Labels:

1. Factory fabricated, flexible, semi-rigid plastic, preformed to fit around pipe or pipe covering.
2. Larger sizes may have maximum sheet size with plastic nylon ties or straps.

D. Plastic Tape Pipe Labels: Flexible, vinyl film tape with pressure sensitive adhesive backing and printed markings.

2.6 CEILING MARKERS

A. Description:

1. 7/8-inch diameter, color-coded.
2. Metal push tacks or 0.030" rigid vinyl, pressure sensitive stickers.

B. Color code as follows:

1. HVAC equipment: Yellow.
2. Plumbing valves: Green.
3. Non potable water and waste water valves: Orange.
4. Heating/cooling valves: Blue.
5. Fire suppression valves and drains: Red.

SECTION 200553 – MECHANICAL IDENTIFICATION

PART 3 - EXECUTION

3.1 PREPARATION

- A. Degrease and clean surfaces to be painted or directly receive adhesive labels.
- B. Install identifying devices after completion of coverings and painting.

3.2 INSTALLATION

- A. Do not install identifying devices over factory installed equipment labels.
- B. Locate identifying devices in clear view for simple identification.
- C. Tag automatic controls, instruments, and relays. Key these to control system schematic drawings.
- D. Frame and install approved equipment and valve directories in each mechanical room, at a location designated by the Contracting Agency.
- E. Pipe Identification:
 - 1. Identify piping, concealed or exposed, using ANSI A13.1 compliant pipe labels. Identify both service and flow direction in accordance with the following table.

Abbreviation	Legend	Color (Letters/Background)
CW	Domestic Cold Water	White/Green
HW	Domestic Hot Water	White/Green
HWC	Domestic Hot Water Circulation	White/Green
GCS	Glycol Cooling Supply	White/Green
GCR	Glycol Cooling Return	White/Green
W	Sanitary Drain	White/Green
V	Sanitary Vent	White/Green
RL, ORL	Rain Leader, Overflow Rain Leader	White/Green

- 2. Pipe label letters shall be a minimum of 1/2" high and increase with pipe diameter as follows:

Pipe Outside Diameter	Letter Height
0.75" to 1.25"	0.5"

SECTION 200553 – MECHANICAL IDENTIFICATION

1.5" to 2"	0.75"
2.5" to 6"	1.25"
8" to 10"	2.5"
over 10"	3.5"

3. Install labels in unobstructed view and aligned with horizontal or vertical axis of piping as appropriate. For piping located above the normal line of vision, place labels below the horizontal centerline of the pipe for clear unobstructed view from below.
4. Install labels not to exceed 20 foot intervals along straight piping runs (including risers and drops), close to valves, adjacent to changes in direction and branches, on each side of pipe penetrations through walls or floors, and at each access panel.

END OF SECTION 20 0553

SECTION 200700 – MECHANICAL INSULATION

PART 1 - GENERAL

1.1 SUMMARY

- A. Section Includes: Specific requirements, products and methods of execution which relate to the insulation of ducts, fittings, equipment, pipes and other surfaces of the mechanical installation.
- B. Related Sections:
 - 1. 20 0000 - Mechanical General Requirements
 - 2. 22 1100 - Domestic Water Piping and Specialties
 - 3. 22 1300 - Sanitary Waste and Vent Piping and Specialties
 - 4. 23 2113 - Hydronic Piping and Specialties
 - 5. 23 3100 - Ducts and Accessories

1.2 REFERENCES

- A. See section 20 0000 - Mechanical General Requirements.
- B. ASHRAE 90.1 - 2010 Energy Standard for Buildings Except Low-Rise Residential Buildings.
- C. NFPA 90A - 2002 Standard for the Installation of Air Conditioning and Ventilating Systems.
- D. NFPA 90B - 2006 Standard for the Installation of Warm Air Heating and Air Conditioning Systems.
- E. MSS Standard Practice SP-58 - Pipe Hangers and Supports - Materials, Design, Manufacture, Selection, Application, and Installation.

1.3 DESCRIPTION

- A. Provide thermal insulation for ventilation system ductwork and building service piping.

1.4 PRE-INSTALLATION MEETINGS

- A. See section 20 0000 - Mechanical General Requirements.

1.5 SUBMITTALS

- A. See Section 20 0000 - Mechanical General Requirements for general submittal requirements for the items listed below, supplemented with the additional requirements listed.
- B. Product Data: Provide product description, thermal characteristics, list of materials and thickness for each service, and locations.

SECTION 200700 – MECHANICAL INSULATION

- C. Qualifications: Submit manufacturer and Applicator qualifications.

1.6 QUALITY ASSURANCE

- A. See section 20 0000 - Mechanical General Requirements.

1.7 DELIVERY, STORAGE AND HANDLING

- A. See section 20 0000 - Mechanical General Requirements.

1.8 WARRANTY

- A. See section 20 0000 - Mechanical General Requirements.

PART 2 - PRODUCTS

2.1 FIRE RATING OF MATERIALS

- A. Provide insulation products used aboveground in building with burning characteristics in compliance with NFPA Standards 90A and 90B: Flame Spread 25, Fuel Contributed 50, Smoke Developed 50. Tested according to UL 723, ASTM E84, or NFPA 255.
- B. Insulation specified for use underground and aboveground away from the building might have other burning characteristics. Use such products only where specifically required.

2.2 FIBERGLASS INSULATION

- A. Piping: Provide insulation products as follows:
 1. Thermal conductivity K equals 0.24 at 100 degrees F mean temperature, ASTM C335.
 2. Factory applied vapor-barrier, flame retardant all service jacket and tape, with permeability rating equal to 0.02 perms, ASTM E 96.
 3. Temperature limits for fiberglass pipe insulation: 350 degrees F, unless otherwise indicated.
 4. Manufacturers: Johns Manville, Owens Corning, Knauf Fiber Glass, or approved equal.
- B. Ductwork: Provide insulation products as follows:
 1. Flexible insulation: Average thermal conductivity K equals 0.24 at 75 degrees F mean temperature at 1.5 pounds per cubic feet (PCF) density, ASTM C335.
 2. Rigid insulation: Average thermal conductivity K equals 0.24 at 75 degrees F mean temperature at 3.0 PCF density, ASTM C518.
 3. Factory-applied vapor barrier flame-retardant Foil-Scrim-Kraft (FSK) or all-service jacket and tape, with permeability rating equal to 0.02 perms, ASTM E 96.
 4. Temperature limits for fiberglass duct insulation: 250 degrees F unless otherwise indicated.

SECTION 200700 – MECHANICAL INSULATION

5. Manufacturers: Johns Manville, Owens Corning, Certainteed, Knauf Fiber Glass, or approved equal.

2.3 FLEXIBLE FOAM PLASTIC

- A. Thermal Conductivity: 0.27.
- B. Water Vapor Transmission: 0.08.
- C. Flame-spread rating of 25 or less and a smoke-developed rating of 50 or less as tested by ASTM E 84.
- D. Manufacturer: Armaflex, Aerotube, Rubatex.

2.4 METAL JACKETING

- A. 27 gauge (U.S. Standard) heavy corrugated aluminum.
- B. Preformed fitting covers.

2.5 COATINGS

- A. Coatings: UL labeled.
- B. On cold or dual service lines, use vapor barrier type coatings.

2.6 PREFORMED FITTING COVERS

- A. One piece pre-molded PVC jacketing and fitting covers specifically designed for the service intended.
- B. Install per manufacturer's instructions and secure with manufacturer's color matching PVC tape.
- C. Manufacturer: J-M "Zeston", TeeCee, Proto, Certainteed.

PART 3 - EXECUTION

3.1 GENERAL

- A. Do not apply insulation materials until surfaces to be covered are clean and dry and foreign material such as rust, dirt, etc. is removed. Keep insulation clean and dry during installation and during the application of any finish.
- B. Do not install the insulation on pipe fittings and pipe joints until the piping has been tested and approved.

SECTION 200700 – MECHANICAL INSULATION

- C. Do not install the insulation on ducts or fittings until the ductwork has been tested and approved.
- D. Do not apply under conditions of excessive humidity or at temperatures below 50 degrees F or above 100 degrees F.
- E. Provide insulation support blocks, shields, and transitions for hangers, supports, anchors, and guides. Coordinate insulation requirements through rated assemblies and Listing penetration’s requirements.
- F. Adjust hangers, guides, anchors, and supports after insulation installation has been approved.

3.2 PIPE INSULATION

A. Cold Piping:

- 1. Includes rainwater piping, domestic cold water, chilled water, and other cold piping to zero degrees F.
- 2. Insulate with sectional fiberglass and provide a completely sealed vapor barrier. Provide insulation thickness per Insulation Thickness Table.
- 3. Insulate valves, unions, flanges, fittings, tanks, vessels, air separators, heat exchangers, and similar components, except where indicated otherwise.

B. Hot Piping:

- 1. Includes domestic hot water supply and recirculation, and hydronic heating.
- 2. Insulate with sectional fiberglass. Provide insulation thickness per Insulation Thickness Table.
- 3. Insulate valves, unions, flanges, fittings, tanks, vessels, air separators, heat exchangers, steam and process vents, and similar components, except where indicated otherwise.

C. In addition to specified jackets, provide heavy corrugated aluminum jacket on piping insulation exterior of the building.

D. Insulation Thickness Table (units are in inches):

Fluid Design Operating Temperature Range	Less than 1	1 to <1-1/2	1-1/2 to <4	4 to <8	8 and up
Heating Systems (Water and Glycol Solutions) and Domestic (Hot Water and Hot Water Circulation):					
141 °F to 200 °F	1.5	1.5	2	2	2
105 °F to 140 °F	1.5	1.5	2	2	2
Cooling Systems (Well water, Chilled Water and Glycol Solutions, and Refrigerant):					
40 °F to 60 °F	1.5	1.5	1.5	1.5	1.5
Below 40 °F	1.5	1.5	1.5	1.5	1.5

SECTION 200700 – MECHANICAL INSULATION

Fluid Design Operating Temperature Range	Less than 1	1 to <1-1/2	1-1/2 to <4	4 to <8	8 and up
Domestic Cold Water:					
All	1	1	1.5	1.5	1.5
Rain leaders, Plumbing vents through roof:					
All	1	1	1.5	1.5	1.5

3.3 TECHNIQUE FOR APPLICATION TO PIPES

- A. Close longitudinal joints of pipe insulation firmly and butt insulation sections firmly together. Neatly and smoothly adhere laps and butt strips.
- B. Clean the contact area on jacket for adhesive lap strips and butt strips so it is free from fingerprints, oil, construction dust and other contaminants. Clean surfaces with tack rags, methanol, or other suitable agent before attempting to adhere the strip. Apply pressure to adhesive strip with suitable tool immediately after adhering. Remove insulation with inadequately sealed joints and install new sections. Outwardly clinching staples may be used to reinforce joints.
- C. Continuously seal vapor barriers. If staples are used at laps, seal the entire length of stapled lap with adhesive jacket tape applied as specified above for laps and butts. Sectionalize vapor barrier by sealing ends of insulation sections at not more than 25 feet intervals, to prevent moisture migrating lengthwise. Apply butt strips over joint as above.
- D. Provide double insulation thickness on piping in outside walls and within five feet of vehicle doors or other large openings.
- E. Except as indicated, locate pipe hangers and rollers outside insulation. Provide insulation saddles or sheet metal shields around insulation. On pipes two inches and larger, within the area of each insulation shield, use calcium silicate or cellular glass on the lower half of the insulation, equal in thickness to adjacent insulation.
- F. Where piping is installed outdoors, provide two-layer glass cloth and four-layer weatherproof vapor barrier adhesive coating, in addition to jacket specified.

3.4 TECHNIQUE FOR APPLICATION TO PIPE FITTINGS, EQUIPMENT, AND VALVES

- A. Insulate fittings, valves, and flanges to the same thickness as the pipe insulation.
- B. Any of the following methods of insulation are acceptable:
 - 1. Blanket Wrap: Wrap the fitting with compressed glass fiber blanket. Wire the blanket securely in place and cover with a smooth layer of insulating/finishing cement. Cover with glass mesh tape, adhering it with an adhesive coating.
 - 2. Fabricated Segments: Cut mitered segments from pipe insulation that has the same wall thickness as adjacent pipe insulation to form a cover which will fit snugly around the

SECTION 200700 – MECHANICAL INSULATION

fitting. Wire the segments firmly in place and seal the joints with insulating/finishing cement. Apply adhesive coating and wrap with glass mesh tape, then apply another layer of the same coating over the whole assembly.

3. Cement: Apply insulating or insulating/finishing cement, molding it to the contour of the fitting. When area is large, apply an under layer of cement, wrap this with glass mesh tape, then apply an outer layer of cement. If the insulation is not concealed the exposed surface of insulating/finishing cement shall have a final glass mesh tape wrap embedded in adhesive.
- C. In each of the listed methods, to protect the insulation against contact damage, apply an adhesive coating when the cement is completely dry and hard, then wrap with glass mesh tape. Apply another coating of adhesive over the whole assembly.
- D. In each of the listed methods, pre-formed fitting covers may be substituted for the tape and adhesive covering specified. Cement and tape fitting covers on cold piping to provide a positive vapor barrier.
- E. Removable insulation blankets of comparable insulation value for valves and where equipment require frequent adjustments or maintenance shall be provided; identify and coordinate during submittal process.
- F. After insulation has been installed adjust hangers for proper fit, maintain pipe grade and support.

3.5 DUCT THERMAL INSULATION REQUIREMENTS

- A. Insulate ductwork as follows:
 1. Supply air ductwork: When mechanical cooling is provided, insulate associated ventilation system supply ductwork from AHU connections to VAV terminal unit inlet connections with 1-1/2 inch thick fiberglass insulation.
 2. Return air ductwork: Insulate return air ductwork passing through unheated spaces, within in mechanical rooms and as indicated with 1-1/2 inch fiberglass insulation.
- B. Insulation Type and Finish:
 1. Rigid or semi-rigid board where canvas or metal jacket is specified. May also be used in place of blanket insulation where practical.
 2. Blanket insulation where rigid board is not specified or indicated. Proper installation is critical. Loose joints and sagging insulation shall require re-insulation of entire branch or main duct before acceptance and during warranty period.
 3. Fiberglass or canvas jacket over board insulation in mechanical and boiler rooms less than 10 feet above finish floor, where exposed in finished rooms and where indicated. Seal jacket with vapor barrier lagging adhesive.
 4. Ductwork insulation to have a completely sealed vapor barrier, except segmental insulation on medium/high velocity trunk ducts and warm air ducts in concealed spaces, where approved.

SECTION 200700 – MECHANICAL INSULATION

3.6 TECHNIQUE FOR APPLICATION TO DUCTWORK

A. Rigid and Semi-rigid Insulation:

1. Impaling Over Pins: Install insulation with edges tightly butted using adhesive and metal pins. Impale insulation on pins welded to the duct and secure with speed clips. Trim off pins close to speed clip. Space pins as required to hold insulation firmly against duct surface but not less than one pin per square foot.
2. Other Method of Securement: If the welded pin method is not feasible, secure the insulation to the duct with adhesive. Cover the entire surface of the metal with adhesive when applying to the underside of horizontal ducts. Application to top and sides may be in strips with a minimum of 50 percent coverage. Additionally, secure insulation with No. 16 galvanized wire on not more than 12 inches on center. Provide metal angle at corners to protect edges of insulation.
3. Vapor Barrier: Seal joints and speed clips with adhesive tape of similar construction to insulation jacket. Thoroughly clean contact surfaces for adhesive as specified under pipe insulation technique. Glass cloth tape set in adhesive may be used. Provide metal or plastic corner angles within eight feet of floor, walkway, or stairs.
4. Provide fiberglass or canvas jacket where specified. Completely cover with minimum 1/8" lagging adhesive. Cover canvas with two heavy coats of same adhesive and completely fill the weave. Inspect when dry for complete vapor barrier throughout and refinish as required.

B. Blanket Insulation:

1. Position insulation so that longitudinal seam will be underneath and not supporting weight of sheet. Remove a uniform strip of insulation from backing to provide a lap strip. Butt insulation and secure lap strip with outwardly clinching staples.
2. Use pins to secure blanket on large flat areas as specified for rigid insulation. Reinforce jacket at pin penetration where required.
3. Seal laps, staples and butt joints with adhesive tape of similar construction to insulation jacket. Seal speed clips if used. Thoroughly clean contact surfaces for adhesive as specified under pipe insulation technique.
4. When system is under pressure, inspect insulation for inflation caused by improperly sealed ducts. Repair duct seal and reinsulate as necessary.
5. The Contracting Agency may inspect completed insulation and test taped joints for adhesion. Seal laps and butt tapes that can be removed with reasonable force shall require that entire branch or trunk duct be reinsulated.

3.7 PAINTING

- A. Paint exposed insulation in utility areas, service areas and mechanical rooms in accordance with Division 9 - Finishes.
- B. Color shall be white or light gray.

END OF SECTION 20 0700

SECTION 200700 – MECHANICAL INSULATION

THIS PAGE INTENTIONALLY LEFT BLANK

SECTION 204100 – MECHANICAL DEMOLITION

PART 1 - GENERAL

1.1 SUMMARY

- A. Section Includes: Demolition and removal of selected mechanical systems, equipment and selected components.
- B. See Division 1 for general demolition requirements and disposal of demolished materials.
 - 1. Coordinate the demolition and disposal of materials and equipment with Contracting Agency.
 - 2. Provide Contracting Agency with the first right of refusal for the salvage of demolished equipment and materials.
- C. Related Sections:
 - 1. 20 0000 - Mechanical General Requirements

1.2 REFERENCES

- A. See section 200000 - Mechanical General Requirements.

1.3 DEFINITIONS

- A. Demolish: Detach items from existing construction and legally dispose of them off-site, unless indicated to be removed and salvaged or removed and reinstalled.
- B. Remove and Salvage: Detach items from existing construction and deliver them to Owner ready for reuse.
- C. Remove and Reinstall: Detach items from existing construction, prepare them for reuse, and reinstall them where indicated.
- D. Existing to Remain: Existing items of construction that are not to be removed and that are not otherwise indicated to be removed, removed and salvaged, or removed and reinstalled.

1.4 SUBMITTALS

- A. See section 200000 - Mechanical General Requirements.
- B. Submit a demolition and construction plan for review by the Contracting Agency prior to beginning work. Describe procedures that will be used to protect and maintain cleanliness of the adjacent building areas/systems during construction.

SECTION 204100 – MECHANICAL DEMOLITION

1.5 QUALITY ASSURANCE

- A. See section 20 0000 - Mechanical General Requirements.
- B. Regulatory Requirements: Comply with governing EPA notification regulations before beginning selective demolition. Comply with hauling and disposal regulations of authorities having jurisdiction.
- C. Standards: Comply with ANSI A10.6 - Safety and Health Program Requirements for Demolition Operations, and NFPA 241 - Standard For Safeguarding Construction, Alteration, And Demolition Operations.
- D. Pre-demolition Meetings: Conduct coordination meetings prior to demolition as required by Division 1.

1.6 PROJECT CONDITIONS

- A. Adjacent portions of the building will remain partially occupied during selective demolition. Conduct demolition such that Owner's operations will not be disrupted.
- B. Drawings and specifications involving existing conditions are based on building record drawings and limited field observation. Provide field verification. Additional building record drawings are available from the Owner with a written request.
- C. Notify Contracting Agency of discrepancies between existing conditions and the Contract Documents before proceeding with demolition.
- D. Hazardous Materials: The existing roof construction, to include the existing mechanical penetrations through the roof is likely to include materials which contain asbestos. If materials suspected of containing hazardous materials are encountered, do not disturb; immediately notify Contracting Agency and coordinate the demolition of such hazardous materials in accordance with the hazardous materials abatement procedures specified in Division 1.
- E. Maintain existing utilities to the maximum extent possible. Coordinate outages, if necessary, in accordance with Division 1.
- F. Maintain fire-protection systems in service during mechanical demolition operations.
- G. Storage or sale of removed items or materials on-site is not permitted.

1.7 WARRANTY

- A. See section 20 0000 - Mechanical General Requirements.
- B. Existing Warranties: Remove, replace, patch, and repair materials and surfaces cut or damaged during selective demolition, by methods and with materials so as not to void existing warranties.

SECTION 204100 – MECHANICAL DEMOLITION

PART 2 - PRODUCTS - NOT USED

PART 3 - EXECUTION

3.1 EXAMINATION

- A. Drawings and specifications involving existing conditions are based on building record drawings and limited field observation.
- B. Conduct a site inspection prior to submission of Bid to become thoroughly familiarized with the Scope of Work. Review actual site conditions and compare with the Contract Documents mechanical demolition drawings. Obtain direction from Contracting Agency for identified conflicts.
- C. Inventory and record the condition of items to be removed, removed and reinstalled or removed and salvaged. Provide Contracting Agency with first right of refusal for the salvage of demolished equipment and materials.
- D. Verify field measurements, locations, sizes, and routing arrangements and site conditions.
- E. When unanticipated mechanical, electrical, or structural elements that conflict with intended function or design are encountered, investigate and measure the nature and extent of conflict. Promptly submit a written report to Contracting Agency for direction.
- F. Commencement of demolition implies Contractor accepts existing conditions.

3.2 PREPARATION

- A. Maintain existing utilities in operation to the maximum extent possible during the selective demolition of mechanical systems. When utility outages are necessary, coordinate outages and their duration with Contracting Agency in accordance with Division 1. Arrange to shut off indicated utilities with utility companies.
- B. “Tag” equipment and systems to be demolished. Identify the extent to which each system will be demolished.
- C. Locate, identify, isolate, disconnect, and seal or cap off indicated utility services and mechanical/electrical systems serving areas to be selectively demolished.
- D. Cut off pipe or conduit in walls or partitions to be removed. Cap, valve, or plug and seal remaining portion of pipe or conduit after bypassing.
- E. Coordinate with the Contracting Agency to provide a central staging area for the temporary storage of demolished equipment and systems.
- F. Identify hazardous materials which will be demolished (i.e. mercury thermostats, etc.). Provide and designate a segregated temporary storage area for demolished hazardous materials organized by hazard type.

SECTION 204100 – MECHANICAL DEMOLITION

3.3 DEMOLITION - GENERAL

A. General:

1. Demolish and remove existing mechanical equipment and systems only to the extent required by new construction and as indicated. Use methods required to complete the Work within limitations of governing regulations and as follows:
2. Terminate ductwork and piping back to branch connections and replace tees and fittings with straight couplings. Terminate electrical circuits back to panel (See Divisions 26, 27 and 28). Remove unused ductwork, piping, conduit and associated hangers and other support devices.
3. Abandonment in place of unused equipment and systems affected by the remodel is not allowed.
4. Neatly cut openings and holes plumb, square, and true to dimensions required. Use cutting methods least likely to damage construction to remain or adjoining construction. Use hand tools or small power tools designed for sawing or grinding, not hammering and chopping, to minimize disturbance of adjacent surfaces. Temporarily cover openings to remain.
5. Cut or drill from the exposed or finished side into concealed surfaces to avoid marring existing finished surfaces.
6. Do not use cutting torches until work area is cleared of flammable materials. At concealed spaces, such as duct and pipe interiors, verify condition and contents of hidden space before starting flame-cutting operations. Maintain fire watch and portable fire-suppression devices during flame-cutting operations.
7. Promptly transport and dispose of demolished equipment, systems and material at the closest, approved dump site.
8. Heating System: Drain, flush and clean the existing hydronic heating systems throughout the entire building. Dispose of existing circulation solutions in an approved manner.

B. Controls:

1. Sequence limited demolition of the controls system.
2. Limited scheduled outages are acceptable for system cross-over.
3. Coordinate outages with Contracting Authority 24 hours in advance of the scheduled outage.

C. Indoor Air Quality:

1. Maintain cleanliness and indoor air quality in areas adjacent to construction areas.
2. Submit a demolition and construction plan for review by the Contracting Agency prior to beginning work.
3. Reference SMACNA IAQ Guidelines for Occupied Buildings Under Construction - Second Edition - 2007.

D. Fire Protection: Notify the Contracting Agency and the Fire Department Agencies at least 24 hours before partially or completely disabling Fire Protection Systems.

E. Removed and Salvaged Items:

1. Clean salvaged items.
2. Pack or crate items after cleaning. Identify contents of containers.
3. Store items in a secure area until delivery to Contracting Agency.
4. Transport items to Contracting Agency designated on-site storage area.
5. Protect items from damage during transport and storage.

SECTION 204100 – MECHANICAL DEMOLITION

F. Removed and Reinstalled Items:

1. Clean and repair items to functional condition adequate for intended reuse. Paint equipment to match new equipment.
2. Pack or crate items after cleaning and repairing. Identify contents of containers.
3. Protect items from damage during transport and storage.
4. Reinstall items in locations indicated. Comply with installation requirements for new materials and equipment. Provide connections, supports, and miscellaneous materials necessary to make item functional for use indicated.

G. Existing items to Remain:

1. Protect construction indicated to remain against damage and soiling during selective demolition.
2. When permitted by Contracting Agency, items may be removed to a suitable, protected storage location during demolition and cleaned and reinstalled in their original locations after demolition operations are complete.

3.4 CLEANING AND REPAIRS

- A. Plug, patch and repair surfaces, adjacent construction, and finishes damaged during demolition and new work. Restore to original condition or better. Retexture surfaces to match surrounding surfaces. Repaint affected surfaces, with extent of paint to include adjacent surfaces to next wall or other clean break to avoid mismatched finish. Repair fire proofing.
- B. Clean construction areas after completion of the project. Wipe down new and existing surfaces including but not limited to walls, floors, ductwork, piping and equipment. Clean adjacent equipment and systems to remain and building surfaces of dust, dirt, and debris caused by demolition operations.
- C. Return adjacent areas to the condition existing before demolition operations began.

END OF SECTION 204100

SECTION 204100 – MECHANICAL DEMOLITION

THIS PAGE INTENTIONALLY LEFT BLANK

SECTION 221100 – DOMESTIC WATER PIPING AND SPECIALTIES

PART 1 - GENERAL

1.1 SUMMARY

A. Section Includes:

1. Pipe, fittings, and connections for domestic potable water system.
2. Piping accessories.
3. Valves.

B. Related Sections:

1. 200000 - Mechanical General Requirements
2. 200513 - Common Motor Requirements
3. 200529 - Mechanical Hangers and Supports
4. 200553 - Mechanical Identification
5. 200700 - Mechanical Insulation
6. 204100 - Mechanical Demolition
7. 221300 - Sanitary Waste and Vent Piping and Specialties
8. 230593 - Testing, Adjusting and Balancing
9. 259000 - Sequence of Operation

1.2 REFERENCES

A. Codes and Standards:

1. See section 200000 - Mechanical General Requirements.
2. Foundation for Cross-Connection Control and Hydraulic Research, 9th edition, University of Southern California.
3. 2011 Reduction of Lead in Drinking Water Act.
4. NSF/ANSI 61 - Drinking Water System Components - Health Effects.

B. Abbreviations, Acronyms and Definitions:

1. Refer to Division 01 for general abbreviations, acronyms, and definitions.
2. Refer to section 200000 - Mechanical General Requirements for general mechanical related definitions.
3. Refer to Mechanical Drawings legend sheet for general mechanical related abbreviations.

1.3 SYSTEM DESCRIPTION

A. Design Requirements:

1. This section describes specific requirements, products and methods of execution for interrelated systems necessary for the various plumbing systems and equipment.

SECTION 221100 – DOMESTIC WATER PIPING AND SPECIALTIES

2. Wetted surfaces of pipes, fittings, valves, and equipment in potable water systems shall be lead free as defined by the 2011 Reduction of Lead in Drinking Water Act.

B. Performance Requirements:

1. Potable water systems shall perform quietly, with no objectionable vibration transmitted to the surrounding construction.
2. Replace piping and equipment that does not perform as intended with properly operating equipment.

1.4 PRE-INSTALLATION MEETINGS

- A. See section 200000 - Mechanical General Requirements.

1.5 SUBMITTALS

- A. Refer to Section 200000 - Mechanical General Requirements for general submittal requirements for the items listed below, supplemented with the additional requirements listed:

B. Product Data:

1. Submit product literature for items specified in Part 2 and those products required by the performance standards of this section. Literature clearly annotated to indicate specified salient features and performance criteria.
2. Indicate valve data and ratings.
3. Provide plumbing specialty component sizes, rough-in requirements, service sizes, and finishes.

C. Shop Drawings:

1. This Section shop drawings to be submitted under Section 200000 - Mechanical General Requirements.
2. Show placement of fixtures and plumbing equipment.

- D. Certificates: Provide certificate of compliance from Authority Having Jurisdiction indicating approval of installation of cross contamination protection devices.

- E. Manufacturer's Installation, Operation, and Maintenance (IO&M) Manuals.

F. Test and Evaluation Reports:

1. Submit hydrostatic pressure test report.
2. Submit sterilization of system report.

SECTION 221100 – DOMESTIC WATER PIPING AND SPECIALTIES

1.6 CLOSEOUT SUBMITTALS:

- A. Refer to Section 200000 - Mechanical General Requirements for general closeout submittal requirements for the items listed below, supplemented with the additional requirements listed:

1.7 MAINTENANCE MATERIAL SUBMITTALS

- A. See section 200000 - Mechanical General Requirements.

1.8 QUALITY ASSURANCE

- A. See section 200000 - Mechanical General Requirements.

1.9 DELIVERY, STORAGE, AND HANDLING

- A. See section 200000 - Mechanical General Requirements.

1.10 WARRANTY

- A. Manufacturer Warranty: See section 200000 - Mechanical General Requirements for general mechanical warranty requirements.

PART 2 - PRODUCTS

2.1 WATER SERVICE PIPING (ABOVE GRADE INSIDE BUILDING)

A. Copper (Hard drawn):

1. Tubing: Type L (ASTM B88).
2. Fittings:
 - a. Cast copper alloy (ASME B16.18).
 - b. Wrought copper and bronze (ASME B16.22).
3. Joints: Solder, Grade 95TA (ASTM B32).

B. Copper Press Fitting System:

1. Limited to tubing sizes 4 inch and smaller.
2. Cast or wrought copper fittings, ASME B16.18 or ASME B16.22. Pre-formed grooves with pre-lubricated EPDM O-rings designed to seal fitting to copper tubing water tight with the use of manufacturer's crimping tool. Fittings shall be rated for 250 degrees F and 200 PSI.
3. IAPMO UPC listing.
4. Manufacturer: Viega ProPress, NIBCO Press System, no substitutions.

SECTION 221100 – DOMESTIC WATER PIPING AND SPECIALTIES

2.2 UNIONS (STANDARD)

A. Steel Piping (Threaded):

1. Class 150 malleable iron, ground joint, copper or copper alloy seat. AnvilStar Figure 463. (150 PSIG steam, 300 WOG).
2. Where indicated: Class 250 malleable iron ground joint, copper or copper alloy seat. AnvilStar Figure 554.

B. Copper Piping (Sweat and Threaded): Cast bronze, ground joint, copper to copper, or copper to threaded joint. Nibco 733-LF series.

2.3 DIELECTRIC ISOLATORS (ELECTRICALLY INSULATING)

A. Provide dielectric unions for 2 inch pipe and smaller.

B. Provide dielectric flanges for 2-1/2 inch pipe and larger.

C. Insulating gaskets, all types, shall be suitable for fluid type, temperature and pressure.

D. Galvanized pipe to copper: Brass threaded end and sweat copper end.

E. Black steel to copper: Zinc plated steel threaded end and sweat copper end.

F. Manufacturers: Capitol, Epc, Control Plastics, Watts, or approved equal.

2.4 VALVES

A. General:

1. Select valves of the best quality and type suited for the specific service and piping system used. Minimum working pressure rating 125 PSIG saturated steam or 200 PSIG WOG. Packing material or seals shall not contain asbestos.

B. Ball Valves:

1. Two (2) inch and smaller: Two piece type, full port, bronze body and silicone bronze ball or chrome plated brass ball, TFE seats, blowout proof stem, 150 PSIG pressure/temperature rating (steam).

C. Drain Valves:

1. Full port ball valve with threaded hose adapter with bronze end cap.
2. Do not use sillcocks or butterfly valves as drain valves.

SECTION 221100 – DOMESTIC WATER PIPING AND SPECIALTIES

2.5 AUTOMATIC FLOW LIMITING VALVES

- A. Provide automatic flow limiting valves where shown on the Drawings.
- B. Provide valves with integral isolation valve, strainer, and pressure test ports.
- C. Provide valve with maximum flow set to design flow of the heat transfer device being served as scheduled.
- D. Manufacturer: Griswold Controls, or equal.

2.6 PRESSURE GAUGES

- A. Provide where shown on drawings, specified in Part 3, or as required.
- B. Bourdon tube type with minimum 4-1/2-inch dial, accuracy plus or minus 1 percent (ANSI/ASME Grade 1A). Normal operating pressure near midpoint of range. Industrial quality.
- C. Type 304 stainless steel case and ring, acrylic lens.
- D. NSF-61 certified lead free brass.
- E. Gauge cock on gauges and pulsation damper (snubber).
- F. Manufacturers: Winters PCT-LF, or approved equal.

2.7 THERMOMETERS

- A. Provide where shown on drawings, specified in Part 3, or as required.
- B. Liquid in glass type: Industrial quality blue-reading with minimum nine-inch scale length. Adjustable angle connection and 360-degree rotation for easy installation and visibility.
- C. Aluminum or Valox® impact resistant case, polycarbonate lens.
- D. Accuracy plus or minus 1 percent. Normal operating temperature at scale midpoint and sufficient range to cover operating conditions.
- E. Provide separable wells of suitable material for plumbing piping. Set probe in heat transfer paste recommended by thermometer manufacturer.
- F. Manufacturers: Winters TIM-LF, or approved equal.

PART 3 - EXECUTION

SECTION 221100 – DOMESTIC WATER PIPING AND SPECIALTIES

3.1 PREPARATION

- A. Protection of In-Place Conditions: Cover equipment and plug piping connections to protect components from construction dirt and debris.

3.2 INSTALLATION

A. Interface with Other Work:

1. Review architectural drawings. Coordinate locations of access panels prior to piping installation.
2. Review millwork shop drawings. Confirm location and size of fixtures and openings before rough-in and installation.
3. Rework required as a result of failure to follow the manufacturer's written installation instructions or to properly coordinate with related work shall be completed at no additional expense to the Owner.
4. Prepare exposed, unfinished pipe, fittings, supports, and accessories ready for finish painting. Refer to Division 9 for instructions on painting and coordination.

B. Water Service Piping:

1. Install piping and plumbing products in accordance with UPC and manufacturer's instructions. Provide seismic anchoring, bracing, supports, and clearance for equipment, piping and sprinkler heads per UPC, IBC, and ASCE-07; most conservative criteria shall govern.
2. Install piping to maintain headroom, conserve space, and not interfere with use of space.
3. Install piping to allow for expansion and contraction without stressing pipe, joints, or connected equipment.
4. At fixtures, install and connect hot water on left and cold water on right, as viewed when facing the fixture.
5. Use of bullhead tee with opposed flow, double inlet configuration not allowed.

C. Valves:

1. Provide accessible ball type isolation valves at major piping branches, and on main lines as shown, and at terminal devices.
2. Install flow limiting valves to be accessible.

D. Provide finished products with protective covers during balance of construction.

E. Access Doors: Provide appropriate size and install such that plumbing features are readily accessible and maintainable.

F. Provide clearance in hangers and from structure and other equipment for installation of insulation and access to valves and fittings.

SECTION 221100 – DOMESTIC WATER PIPING AND SPECIALTIES

3.3 REPAIR/RESTORATION

- A. Repair any product components broken during installation or startup with replacement parts supplied by the product manufacturer.
- B. Substitute replacement parts from other manufacturers are not acceptable.

3.4 SITE QUALITY CONTROL

A. Site Tests:

- 1. Test water piping hydrostatically at 100 PSIG or 150 percent of working pressure, whichever is greater, for a period of four hours. Observe piping during this period and repair leaks and retest.
- 2. Air Test:
 - a. In general, air testing is not acceptable. In the event of low temperature conditions that would subject system piping to freezing, an equivalent air pressure test may be conducted in accordance with the Uniform Plumbing Code with prior Contracting Agency approval.
 - b. Test with clean air at 150 percent of system working pressure but not less than 75 PSIG or more than 150 PSIG. System shall hold pressure for not less than four hours. Inspect joints using leak detecting fluid or soapy water. Repair leaks and retest.
 - c. Observe necessary safety procedures when testing with air including, but not limited to, use of protective goggles or face shields. Only persons directly involved in testing procedure shall be within 20 feet of a pipe under pressure.
- 3. Test results shall be certified in writing as required by General Conditions. Include dates and sections tested, test pressure, test duration, printed names and signatures of person performing the test and Contracting Agency witnessing the test.

B. Inspection:

- 1. Arrange for inspections and provide notice to the Contracting Agency when the entire work or logical portions thereof, is ready for inspection.

3.5 SYSTEM STARTUP

- A. Start-up and operate plumbing systems and equipment in accordance with the manufacturer's written installation and operation manual checklist.
- B. Document start-up and operational checks using the checklist and submit in accordance with submittal requirements.
- C. Operationally test control and safety devices and record settings.
- D. Submit a copy of start-up report that includes final settings and that indicates that the start-up of each piece of equipment has been completed.

SECTION 221100 – DOMESTIC WATER PIPING AND SPECIALTIES

3.6 CLEANING

A. Sterilization of Domestic Water Systems:

1. Sterilize each unit of completed supply line and distribution system with chlorine before acceptance for domestic operation.
2. Sterilization as described below or by the system prescribed by the American Water Works Association Standard C-651. Apply the amount of chlorine to provide a dosage of not less than 50 PPM (parts per million). Provide chlorine manufactured in conformance to the following standards:
 - a. Liquid Chlorine: Federal Specification BB-C-120.
 - b. Hypochlorite: General Specification O-C-114a, type 11, Grade B or Federal Specification O-X-602.
3. Introduce the chlorinating material to the water lines and distribution system after piping system has been thoroughly flushed. Maintain a contact period of not less than 24 hours. Flush the system with clean water until the residual chlorine content is not greater than 1.0 part per million.
4. Open and close valves in the lines being sterilized several times during above chlorination.
5. Certify in writing that sterilization has been completed in accordance with these requirements.

B. After construction is completed, clean and wipe down exposed surfaces of pumps, piping and appurtenances.

END OF SECTION 221100

SECTION 221300 – SANITARY WASTE AND VENT PIPING AND SPECIALTIES

PART 1 - GENERAL

1.1 SUMMARY

A. Section Includes:

1. Sanitary waste and vent pipe and fittings.

B. Related Sections:

1. 200000 - Mechanical General Requirements
2. 200529 - Mechanical Hangers and Supports
3. 200553 - Mechanical Identification
4. 204100 - Mechanical Demolition
5. 221100 - Domestic Water Piping and Specialties
6. 230593 - Testing, Adjusting and Balancing
7. 259000 - Sequence of Operation

1.2 REFERENCES

A. Codes and Standards: See section 200000 - Mechanical General Requirements.

B. Abbreviations, Acronyms and Definitions:

1. Refer to Division 01 for general abbreviations, acronyms, and definitions.
2. Refer to Section 200000 - Mechanical General Requirements for general mechanical related definitions.
3. Refer to Mechanical Drawings legend sheet for general mechanical related abbreviations.
4. ASA - American Supply Association.
5. ASTM - American Society for Testing and Materials
6. CISPI - Cast Iron Soil Pipe Institute.

1.3 SYSTEM DESCRIPTION

A. Design Requirements: This section describes specific requirements, products and methods of execution for sanitary waste systems and equipment.

B. Performance Requirements:

1. Sanitary waste systems shall perform quietly, with no objectionable vibration transmitted to the surrounding construction.
2. Replace piping that does not perform as intended with properly operating equipment.
3. Provide products with performance, output or salient features indicated or scheduled on the drawings.

SECTION 221300 – SANITARY WASTE AND VENT PIPING AND SPECIALTIES

1.4 PRE-INSTALLATION MEETINGS

- A. See section 200000 - Mechanical General Requirements.

1.5 SUBMITTALS

- A. See section 200000 - Mechanical General Requirements for general submittal requirements for the items listed below, supplemented with the additional requirements listed:
- B. Product Data:
 - 1. Submit product literature for items specified in Part 2 and those products required by the performance standards of this section. Clearly annotate literature to indicate specified salient features and performance criteria.
 - 2. Provide plumbing specialty component sizes, rough-in requirements, service sizes, and finishes.
- C. Shop Drawings:
 - 1. This Section shop drawings to be submitted under Section 200000 - Mechanical General Requirements.
 - 2. Indicate pipe grade and direction of slope. Indicate elevation of piping at the beginning and end of each main, and at branch connections.
 - 3. Coordinate exact locations of drains, floor penetrations and structural penetrations with applicable trades.
- D. Manufacturer's Installation, Operation and Maintenance Manuals.
- E. Test and Evaluation Reports:
 - 1. Submit pressure test report.
 - 2. Submit system flushing report.

1.6 CLOSEOUT SUBMITTALS

- A. See section 200000 - Mechanical General Requirements for general closeout submittal requirements for the items listed below, supplemented with the additional requirements listed:
- B. Warranty Documentation.
- C. Record Documentation.

1.7 MAINTENANCE MATERIAL SUBMITTALS

- A. See section 200000 - Mechanical General Requirements.

SECTION 221300 – SANITARY WASTE AND VENT PIPING AND SPECIALTIES

1.8 QUALITY ASSURANCE

- A. See section 200000 - Mechanical General Requirements.

1.9 DELIVERY, STORAGE, AND HANDLING

- A. See section 200000 - Mechanical General Requirements.

1.10 WARRANTY

- A. Manufacturer Warranty: See section 200000 - Mechanical General Requirements for general mechanical warranty requirements.

PART 2 - PRODUCTS

2.1 DRAINAGE PIPING, ABOVE GRADE

- A. Copper Pipe, DWV: ASTM B75, ASTM B251, ASTM B302, ASTM B306.
 - 1. Fittings: ASME B16.23 cast bronze, or ASME B16.29 wrought copper.
 - 2. Joints: ASTM B32, lead-free solder, Grade 50B.
- B. Copper Pipe, pumped application: Type L, ASTM B88.
 - 1. Fittings: ASME B16.23 cast bronze, or ASME B16.29 wrought copper.
 - 2. Joints: ASTM B32, lead-free solder, Grade 50B.

PART 3 - EXECUTION

3.1 PREPARATION

- A. Interface with Other Work:
 - 1. Review architectural and millwork shop drawings. Confirm location of cleanouts and access panels prior to installation.
 - 2. Coordinate and sequence installation of roof drains and piping with trades responsible for portions of this and other related sections of the Project Manual.
- B. Protection: Cover equipment and plug piping connections to protect components from construction dirt and debris.

3.2 INSTALLATION

- A. Install plumbing systems in accordance with manufacturer's instructions and listing.

SECTION 221300 – SANITARY WASTE AND VENT PIPING AND SPECIALTIES

- B. Provide finished products with protective covers during balance of construction.
- C. Piping:
 - 1. Grading: Minimum 1/4 inch per foot unless indicated otherwise on drawings and approved by AHJ for shallower slopes.
 - 2. Install piping to maintain headroom, conserve space, and not interfere with use of space.
 - 3. Install piping to allow for expansion and contraction without stressing pipe, joints, or connected equipment.
 - 4. Provide clearance in hangers and from structure and other equipment for installation of insulation and access to valves and fittings.
 - 5. Where pipe support members are welded to structural building framing; scrape, brush clean, and apply one coat of zinc rich primer to welding.
 - 6. Prepare exposed, unfinished pipe, fittings, supports, and accessories ready for finish painting. Refer to Division 9 - Finishes.
 - 7. Connections:
 - a. Thread Joints: Assemble with TFE tape or approved non-hardening joint compound.
 - b. Solder Joints: Assemble with lead free solder.

3.3 REPAIR/RESTORATION

- A. Rework required as a result of failure to follow the manufacturer's written installation instructions or to properly coordinate with related Work shall be completed at no additional expense to the Owner.
- B. Repair any product components broken during installation or startup with replacement parts supplied by the product manufacturer.
- C. Substitute replacement parts from other manufacturers are not acceptable.

3.4 FIELD QUALITY CONTROL

- A. Inspections: Arrange for inspections and provide notice to the Contracting Agency when the entire Work, or logical portions thereof, is ready for inspection.
- B. Maintain current as-built drawings on-site recording including invert elevations, connections to fixtures, cleanouts, slopes, pipe sizes, and routing of pipes. Annotate sections of lines with dates when pressure tests have been approved by AHJ.
- C. Pressure Tests:
 - 1. Water Test: Test waste and vent system with water in accordance with the Uniform Plumbing Code.
 - 2. Air Test:
 - a. In general, air testing is not acceptable. In the event of low temperature conditions that would subject system piping to freezing, an equivalent air pressure test may be

SECTION 221300 – SANITARY WASTE AND VENT PIPING AND SPECIALTIES

conducted in accordance with the Uniform Plumbing Code with prior Contracting Agency approval.

- b. Observe necessary safety procedures when testing with air including, but not limited to, use of protective goggles or face shields. Only persons directly involved in testing procedure shall be with 20 feet of a pipe under pressure.
3. Test results shall be certified in writing as required by General Conditions. Include dates and sections tested, test pressure, test duration, printed names and signatures of person performing the test and Contracting Agency witnessing the test.
- D. Verify penetrations are installed to maintain assembly integrity.
 - E. Coordinate with Divisions 26, 27 and 28 for power, disconnects, and related electrical items.

3.5 ADJUSTING

- A. Adjust functional components for proper operation in accordance with manufacturer's recommendations, or as otherwise directed.

3.6 CLEANING

- A. Clean and flush drain piping to remove dirt and foreign debris from systems.
- B. Clean exposed pipes, fittings, and materials.
- C. Provide written certification which documents that the complete sanitary sewer system has been flushed of foreign debris. Include date and printed names and signatures of person(s) performing the flush and Contracting Agency witnessing the flush.

3.7 CLOSEOUT ACTIVITIES

- A. Start-up and operate plumbing systems and equipment in accordance with the manufacturer's written installation and operation manual checklist.
- B. Document start-up and operational checks using the checklist and submit in accordance with submittal requirements.

END OF SECTION 221300

SECTION 221300 – SANITARY WASTE AND VENT PIPING AND SPECIALTIES

THIS PAGE INTENTIONALLY LEFT BLANK

SECTION 230593 – TESTING, ADJUSTING AND BALANCING

PART 1 - GENERAL

1.1 SUMMARY

- A. Section Includes: General requirements and methods of execution relating to the testing and balancing of the mechanical systems provided on this project.
- B. Related Sections:
 - 1. 200000 - Mechanical General Requirements
 - 2. 200513 - Common Motor Requirements
 - 3. 232113 - Hydronic Piping and Specialties
 - 4. 232123 - Hydronic Pumps
 - 5. 233100 - Ducts and Accessories
 - 6. 233700 - Air Outlets and Inlets
 - 7. 236400 - Packaged Water Chillers
 - 8. 238123 - Dedicated Air-Conditioning Units
 - 9. 254000 - Variable Speed Drives
 - 10. 259000 - Sequence of Operations

1.2 REFERENCES

- A. Codes and Standards:
 - 1. See section 200000 - Mechanical General Requirements.
 - 2. National Environmental Balancing Bureau - Procedural Standards for Testing, Adjusting, Balancing of Environmental Systems.
 - 3. National Environmental Balancing Bureau - Testing, Adjusting, Balancing Manual for Technicians.
 - 4. SMACNA - HVAC SYSTEMS Testing, Adjusting, and Balancing.
- B. Abbreviations and Acronyms:
 - 1. Refer to Division 01 for general abbreviations, acronyms, and definitions.
 - 2. Refer to Mechanical Drawings legend sheet for general mechanical related abbreviations.
 - 3. TAB: Testing, Adjusting, and Balancing.
 - 4. NEBB: National Environmental Balancing Bureau
- C. Definitions:
 - 1. Refer to Section 200000 - Mechanical General Requirements for general mechanical related definitions.
 - 2. Accuracy: Capability of an instrument to indicate the true value of a measured quantity.
 - 3. Adjusting: Varying of system flows by partially closing balancing devices, such as dampers, and valves, and varying fan speeds to achieve optimum system operating conditions within design and installation limitations.

SECTION 230593 – TESTING, ADJUSTING AND BALANCING

4. Balancing: Methodical proportioning of air and hydronic flows through the system main, branches, and terminal devices using acceptable procedures to achieve the specified air or hydronic flow with testing and design limitations.
5. Calibrate: The act of comparing an instrument of unknown accuracy with a standard of known accuracy to detect, correlate, report, or eliminate by adjustment any variation in the accuracy of the tested instrument.
6. NEBB Certified TAB Firm: A Firm that has met and maintains all the requirements of the NEBB for Firm certification in TAB and is currently certified by NEBB. A NEBB Certified Firm shall employ at least one NEBB Qualified TAB Supervisor in the full time management position.
7. NEBB Certified TAB Report: Data presented in a NEBB Certified TAB Report accurately represents system measurements obtained in accordance with the current edition of the *NEBB Procedural Standards for Testing, Adjusting, and Balancing of Environmental Systems*. Variances from design quantities that exceed NEBB or contract document tolerances are to be noted in the TAB report project summary.
8. NEBB Qualified TAB Supervisor: Full time employee of the TAB Firm in a management position who has successfully passed the supervisor level written and practical qualification examinations and maintains the Supervisor re-qualification requirements of NEBB.
9. NEBB Qualified Technician: Full time employee of the TAB Firm who has met the technician level experience requirements of NEBB and has successfully passed the technician level written and practical qualification examinations. A NEBB Qualified TAB Technician shall be supervised by a NEBB Qualified TAB Supervisor. Supervision does not infer constant oversight; a NEBB Qualified Technician is capable of performing assigned tasks with periodic supervision.
10. Precision: Ability of an instrument to produce repeatable readings of the same quantity, or a tightly grouped set of values, under the same conditions.
11. Range: Upper and lower limits on an instrument's ability to measure the value of a quantity for which the instrument is calibrated.
12. Resolution: Smallest change in a measured variable that an instrument can detect.
13. Testing: Use of specialized and calibrated instruments to measure temperatures, pressures, rotational speeds, electrical characteristics, velocities, and air and hydronic quantities for an evaluation of flow conditions.
14. Testing and Balancing: As used in these specifications, testing and balancing refers to testing, adjusting, and balancing (TAB) as described in the above references.
15. TAB: A systematic process or service applied to heating, ventilating and air-conditioning (HVAC) systems and other environmental systems to achieve and document air and hydronic flow rates. The standards and procedures for providing these services are referred to as "Testing, Adjusting, and Balancing" and are described in this document.

1.3 SYSTEM DESCRIPTION

- A. Design Requirements: This section describes specific requirements, products and methods of execution for the testing, adjusting and balancing of the project.
- B. Performance Requirements: Furnish the services of a qualified and approved TAB Firm to perform the work of this specification section.
- C. The work of this section includes but is not necessarily limited to:

SECTION 230593 – TESTING, ADJUSTING AND BALANCING

1. Test and balance fans and supply, exhaust and relief ventilating systems.
2. Test and balance hydronic heating and chilled water systems.
3. Work directly with the control subcontractor to obtain proper system adjustments. This includes, but is not limited to:
 - a. VAV, RAV, EAV box controller airflow coefficient adjustments.
 - b. Airflow measuring device calibration adjustments.
 - c. Fluid flow measuring device calibration adjustments.
4. Provide a final report.

D. The work of this section does not include:

1. Adjusting burners for proper combustion operation.
2. Liquid waste transfer system adjustment.
3. Refrigeration work.
4. Control system adjustments, unless noted otherwise herein.

1.4 PRE-BALANCING MEETING

- A. Coordinate TAB work with other trades and requirements of other related sections of the Project Manual prior to commencing work.
- B. Schedule a pre-balancing meeting one week prior to commencing work of this Section. Refer to Section 200000 - Mechanical General Requirements.

1.5 SUBMITTALS

- A. See Section 200000 - Mechanical General Requirements for general submittal requirements for the items listed below, supplemented with the additional requirements listed.
- B. Product Data: Sample report forms and outlines indicating adjusting, balancing, and equipment data required prior to commencing work.
- C. Certificates:
 1. Submit the name and qualifications of TAB Firm for approval with general product submittals. Submit copy of TAB Firm's NEBB certification.
 2. Submit the names and certifications of the Firm's NEBB Qualified TAB Supervisor and NEBB Certified Technician.
- D. Balancing Report:
 1. Submit a complete report of the testing and balancing of all devices in a format equivalent to that shown in the SMACNA HVAC Systems Testing, Adjusting and Balancing manual. Compile the test data and submit eight copies of the complete test data for acceptance and/or analysis and recommendations.
 2. Provide report in soft cover, letter size, comb bound binder manuals, complete with index page and indexing tabs, with cover identification at front and side. Include drawings within report.

SECTION 230593 – TESTING, ADJUSTING AND BALANCING

3. Report Cover Sheet. Include the following data:
 - a. Project Name.
 - b. Project Address.
 - c. Names of Architect and Engineer.
 - d. Names of General Contractor and HVAC Contractor.
 - e. Report date.
 - f. Names of TAB technicians responsible for the measurements and report.
4. System Review Sheet:
 - a. List air and hydronic systems balanced, with systems highlighted that were found to be performing outside design tolerances.
 - b. Include a summary of problems encountered, deviations from design, deficiencies in performance, remaining problems, recommendations, and comments.
5. Instrument Calibration Report:
 - a. Include a complete list of test equipment used, including apparatus manufacturer's name, model number, serial number, and date last calibrated.
 - b. List the instruments used on the project during the balancing work, on an NEBB "Instrument Calibration Report" form, or equivalent form. This includes flow measuring hoods and other related devices.
6. Air Systems Report: Prepare a report for each air system balanced. Tabulate data separately for each system. Describe balancing method used for each system. At minimum, include the following:
 - a. System Diagram: Include locations of air terminal units and pitot tube traverses. Include appropriate notes, static pressure reading locations, etc., taken during testing and balancing.
 - b. Air Apparatus or Fan Test Report: Include pertinent data on the test report forms. If test data could not be measured, or is not applicable, indicate such on report forms. List how each actual cfm measurement was obtained (duct traverse, total of outlet airflows, or a combination).
 - c. Duct Pitot Tube Traverse Reports: Include actual temperature and pressure readings recorded at the time of testing and balancing.
 - d. Air Outlet Test Reports: Include applicable A_k factors and terminal device sizes. If flow measuring hoods are used, indicate their use in the remarks column.
 - e. Include complete identification of elements. Identify by box number, room name and number, air outlet symbol, orientation in room, etc., as necessary to clearly and positively identify the location of each element.
7. Hydronic Heating and Cooling System Reports. Prepare a report for each hydronic system balanced. Tabulate data separately for each system. Describe balancing method used for each system. At minimum, include the following:
 - a. Schematic Diagram: Include heat exchange equipment and locations of flow measuring devices.
 - b. Pump Test Report: Confirm test data was recorded and properly entered on form. Attach manufacturer's pump capacity curves, with the actual pump operating point plotted, to the test report form. List how the actual pump flow rate was determined (flow meter, pump curve, etc.).

SECTION 230593 – TESTING, ADJUSTING AND BALANCING

- c. Primary Heat Exchange Equipment: Confirm that appropriate test data has been recorded for the boilers, heat exchangers, chillers, and other primary heat exchange equipment. List how the actual flow rate(s) of each item was determined.
 - d. Terminal Heat Exchange Equipment: Confirm that heating coil and terminal unit temperatures and pressures were recorded and properly entered on form. List how each terminal unit flow rate was determined.
 - e. Include complete identification of elements. Identify by equipment tag number, room name and number, baseboard symbol, orientation in room, etc., as necessary to clearly and positively identify the location of each element.
8. Reduced Size Drawings: Provide with air outlets and equipment identified to correspond with data sheets. Record actual locations of thermostats, flow measuring stations, and balancing valves with settings.

1.6 QUALITY ASSURANCE

A. Qualifications:

1. The work described in this section shall be performed by a Firm certified by the National Environmental Balancing Bureau for air and hydronic balancing.
2. The Firm shall have a record of operation within Alaska for at least three years prior to bid date of this project and shall have demonstrated satisfactory completion of five projects of similar size and scope in the State of Alaska. Provide references if requested.
3. The Firm's Technician and Supervisor for this project shall be NEBB certified for their respective positions.
4. Bids by suppliers, contractors or any Firm whose principal business is not that of testing, adjusting, and balancing HVAC systems are not acceptable.

B. Balancing Standards:

1. Perform total system balance in accordance with NEBB Procedural Standards for Testing, Adjusting, and Balancing of Environmental Systems.
2. Maintain one copy of balancing procedural document on site.
3. Use standard NEBB forms.

C. Timing of Work:

1. Sequence work to commence after completion of systems. Do not begin balancing and testing until the systems are complete and in full working order.
2. Schedule the testing and balancing work in cooperation with other trades.
3. Schedule completion of testing and balancing before Substantial Completion of Project.

D. Construction team responsibility to TAB Agency: Refer to 200000 - Mechanical General Conditions.

SECTION 230593 – TESTING, ADJUSTING AND BALANCING

PART 2 - PRODUCTS - NOT USED

PART 3 - EXECUTION

3.1 EXAMINATION

- A. Verify systems are complete and operable before commencing work.
- B. Examine systems for functional deficiencies that cannot be corrected by adjusting and balancing.
- C. Report defects and deficiencies that may preclude proper TAB of systems and equipment.

3.2 PREPARATION

- A. Schedule work under the provisions of Section 200000 - Mechanical General Conditions.
- B. Provide calibrated instruments required for testing, adjusting, and balancing operations.
- C. Prior to starting work, review drawings and actual field conditions for additional balancing devices or components required for correct balance. Coordinate provision of additional balancing devices as required elsewhere in these specifications. Refer to Related Sections above.
- D. Preliminarily adjust grille, register, and diffuser blades or pattern controllers per drawings. If airflow blow patterns are not shown on drawings, adjust for uniform diffusion pattern(s) or diffusion into long dimension of room.

3.3 SPECIAL TECHNIQUES:

- A. Use instrumentation in accordance with NEBB requirements, calibrated to the accuracy standards specified by this organization.
- B. Flow measuring hoods are acceptable for measurement of ceiling diffuser performance if used in a manner as recommended by the manufacturer and calibration and accuracy data is provided with the balancing report.
- C. Upon request, make available to the Contracting Agency copies of current calibration certificates.

SECTION 230593 – TESTING, ADJUSTING AND BALANCING

3.4 ACCEPTABLE CRITERIA

- A. Systems will be considered balanced in accordance with NEBB *Procedural Standards for Testing, Adjusting, and Balancing of Environmental Systems* when the following conditions are satisfied:
1. Air Handling Systems:
 - a. Measured airflow quantities are within plus or minus 10 percent of design quantities. Deficiencies shall be noted in the TAB report.
 - b. There is at least one direct path with fully open dampers from the fan or terminal unit device to an air inlet or outlet. Additionally, if a system contains branch dampers, there will be at least one wide open path downstream of every adjusted branch damper.
 2. Air Outlets and Inlets:
 - a. Measured airflow quantities total to within plus or minus 10 percent of design to space and individual outlets and inlets in space to within plus or minus 10 percent of design.
 - b. Grilles, registers, and diffusers blades or pattern controllers are adjusted for uniform diffusion in the space. Re-adjust airflow patterns that result in airflow velocities greater than 50 FPM (feet per minute) at 5 feet above finish floor (AFF).
 3. Hydronic Systems:
 - a. Automatically balanced systems: Pressure drops across a sample of system's automatic balance valves are within the manufacturer's recommended operating range for the device.
- B. If systems or components cannot be adjusted to within specified tolerances:
1. Coordinate the replacement of sheaves, belts, or other components or devices needed for correct balance as required elsewhere in these specifications.
 2. Note deficiencies in the TAB report.

3.5 GENERAL PROCEDURES FOR TESTING AND BALANCING

- A. Perform testing and balancing procedures on equipment sheaves, belts, dampers, valves, air outlets and inlets and each system according to the procedures contained in the current edition of the NEBB *Procedural Standards for Testing, Adjusting, and Balancing of Environmental Systems* and this section.
- B. Adjustments shall be made with air handler filters blanked off to create a filter pressure drop of 60 percent of the manufacturer's recommended filter final pressure. Where multiple filters are encountered each set shall be individually blanked off, for a cumulated pressure drop of 60 percent of each filters final pressure.
- C. Ensure recorded data represents actual measured or observed conditions.
- D. Permanently mark final settings of valves, dampers, and other adjustment devices allowing settings to be restored. Set and lock memory stops.

SECTION 230593 – TESTING, ADJUSTING AND BALANCING

- E. After adjustment, take measurements to verify balance has not been disrupted or that such disruption has been rectified.
- F. Leave systems in proper working order, replacing belt guards, closing access doors, closing doors to electrical switch boxes, and restoring thermostats to specified settings.
- G. At final inspection, recheck random selections of data recorded in report. Recheck points or areas as selected and witnessed by the Contracting Agency.
- H. Schedule and provide assistance in final adjustment and test of fire alarm system with Authority Having Jurisdiction.

3.6 SITE QUALITY CONTROL

- A. Make calibrated test instruments available to Contracting Agency to facilitate spot checks during testing and commissioning as appropriate.
- B. Re-balance components or systems found to be out of tolerance at no additional expense to the Owner.

END OF SECTION 230593

SECTION 232113 – HYDRONIC PIPING AND SPECIALTIES

PART 1 - GENERAL

1.1 SUMMARY

A. Section Includes:

1. Pipe and fittings for:
 - a. Hydronic heating and cooling piping.
 - b. Equipment drains and overflows.
2. Piping accessories.
3. Flexible pipe connectors.
4. Expansion joints and compensators.
5. Pipe loops, offsets, alignment guides and swivel joints.
6. Hydronic Specialties:
 - a. Air vents.
 - b. Strainers.
 - c. Flushing agents.
 - d. Water treatment chemicals.
 - e. Glycol specialties.

B. Related Sections:

1. 200000 - Mechanical General Requirements
2. 200529 - Mechanical Hangers and Supports
3. 200553 - Mechanical Identification
4. 200700 - Mechanical Insulation
5. 204100 - Mechanical Demolition
6. 230593 - Testing, Adjusting and Balancing
7. 232123 - Hydronic Pumps
8. 236400 - Packaged Water Chillers
9. 259000 - Sequence of Operations

1.2 REFERENCES

A. Codes and Standards:

1. See section 200000 - Mechanical General Requirements.
2. ANSI/ASHRAE/IENA Standard 90.1-2001 Energy Standard for Buildings Except Low-Rise Residential Buildings.
3. ASME Boilers and Pressure Vessel Code (1998), Sections IV & VI.

B. Abbreviations, Acronyms and Definitions:

1. Refer to Division 01 for general abbreviations, acronyms, and definitions.
2. Refer to Section 200000 - Mechanical General Requirements for general mechanical related definitions.
3. Refer to Mechanical Drawings legend sheet for general mechanical related abbreviations.

SECTION 232113 – HYDRONIC PIPING AND SPECIALTIES

1.3 SYSTEM DESCRIPTION

A. Design Requirements:

1. This section describes specific requirements, products, and methods of execution for the system of liquid heat transfer throughout the project.
2. Design expansion compensation system to adequately protect piping and structure from thermal expansion and contraction forces.

B. Performance Requirements:

1. Provide performance and output shown or scheduled on drawings.
2. Provide loops, pipe offsets, and swing joints, or expansion joints where required or indicated.
3. Pipes shall be capable of thermal expansion movement without disengagement of supports or forces on equipment connections.
4. Provide structural work and equipment required to control expansion and contraction of piping. Verify that anchors, guides, and expansion joints provided, adequately protect system.
5. Expansion Calculations:
 - a. Installation Temperature: 80 degrees F.
 - b. Chilled Water Cooling: 44 degrees F.
 - c. Safety Factor: 30 percent.

1.4 PRE-INSTALLATION MEETINGS

- #### A. See section 200000 - Mechanical General Requirements.

1.5 SUBMITTALS

- #### A. See Section 200000 - Mechanical General Requirements for general submittal requirements for the items listed below, supplemented with the additional requirements listed.

B. Product Data:

1. Submit product literature for items specified in Part 2 and those products required by the performance standards of this section. Literature clearly annotated to indicate specified salient features and performance criteria.
2. Flexible Pipe Connectors: Indicate maximum temperature and pressure rating, face-to-face length, live length, hose wall thickness, hose convolutions per foot (meter) and per assembly, fundamental frequency of assembly, braid structure, and total number of wires in braid.
3. Expansion Joints: Indicate maximum temperature and pressure rating, and maximum expansion compensation.
4. Submit selection calculations for expansion joints and compensators.
5. Design Data: Submit calculations for performance specified products and systems.

C. Shop Drawings:

1. Submit shop drawings for performance-specified products and systems.
2. Submit shop drawings for piping systems to demonstrate proper layout and coordination.

SECTION 232113 – HYDRONIC PIPING AND SPECIALTIES

3. Provide shop drawings to show system layout with location and detail of flexible pipe connectors and expansion joints.
4. Drawings of boiler room, fan rooms, and other areas with high-density piping, shall be shown at 1/4-inch scale or larger.
5. Indicate elevation of piping above finish floor.
6. Indicate dimensions and weights of equipment, and placement of openings and holes.
7. Include reference to ductwork and other equipment where space coordination is necessary to avoid conflicts.
8. Indicate mechanical and electrical service locations and requirements.

D. Manufacturer Reports:

1. Certificates, Manufacturer's Instructions, and Manufacturer's Field Reports:
 - a. Provide a complete manufacturer's written installation, operation and maintenance manual for each type of installed equipment. Annotate the manual to indicate applicable information for the specific equipment model(s) installed.
 - b. Included with the manual one copy of the completed start-up and operation checklist. The checklist shall include:
 - 1). Printed names and signatures of the installers.
 - 2). Documentation from Manufacturer's representative and Contracting Agency that the equipment has been properly installed and is fully operational, thus validating the equipment warranty.
2. Test reports:
 - a. Provide certificate that cleaning of hydronic systems has been accomplished.
 - b. Provide certificate listing satisfactory results for the hydrostatic pressure tests.
 - c. Provide certificate listing satisfactory results for the operational tests.
3. Submit a letter to document that the training was conducted. Include in the letter the date, start/stop times for the training, list of attendees and signature/title of the person(s) providing the training.

1.6 CLOSEOUT SUBMITTALS

- A. See section 200000 - Mechanical General Requirements.
- B. Operation and Maintenance (IO&M) Manuals:
 1. Refer to Section 200000 - Mechanical General Requirements, for IO&M Manual formatting requirements and number of copies required.
 2. Include the following:
 - a. Copies of approved submittal information.
 - b. Manufacturer's installation, operating and maintenance/repair instructions, parts listings, and spare parts list for each product. Annotate the manual to indicate applicable information for the specific equipment model(s) installed.
 - c. Computer software manuals and applicable licenses.
 - d. Completed start-up and operational test report as required to validate equipment warranty.
 - e. Start-up and operational test reports for each piece of equipment. Report shall include printed names and signatures of the installers and documentation that the

SECTION 232113 – HYDRONIC PIPING AND SPECIALTIES

equipment has been properly installed and is fully operational, thus validating the equipment warranty.

- C. Record Documentation: Record actual locations of equipment, valves, strainers, air vents, flexible pipe connectors, expansion joints, other components, and locations of access doors required for maintenance access in accordance with Section 200000 - Mechanical General Requirements.

1.7 MAINTENANCE MATERIAL SUBMITTALS

- A. See section 200000 - Mechanical General Requirements.

1.8 QUALITY ASSURANCE

- A. See section 200000 - Mechanical General Requirements.

1.9 DELIVERY, STORAGE, AND HANDLING

- A. See section 200000 - Mechanical General Requirements.

1.10 WARRANTY

- A. Manufacturer Warranty: See section 200000 - Mechanical General Requirements, for general mechanical warranty requirements.

PART 2 - PRODUCTS

2.1 PIPE AND FITTINGS

- A. Glycol Systems (Copper or Steel Option):
 - 1. Copper pipe three inches and smaller:
 - a. Type L copper, wrought copper fittings.
 - b. Fit joints using 430 silver solder, 95-5 tin-antimony or other approved lead-free solder. Solder type must be compatible with pipe and fittings. Solder containing lead shall not be allowed on the job site.
 - c. Soldering flux: Water flushable, low corrosivity type meeting the requirements of ASTM B813. Flux shall have label indicating it meets these requirements.
 - d. Extracted branch joints (T-Drill) may be approved when Contractor can demonstrate satisfactory experience with this method. All joints shall be brazed in accordance with the Copper Development Association Copper Tube Handbook using B-Cup series filler metal.
 - 2. Victaulic mechanical joint-type pipe systems are not permitted.
- B. Copper Press Fitting System:

SECTION 232113 – HYDRONIC PIPING AND SPECIALTIES

1. Limited to tubing sizes 4 inch and smaller.
2. Cast or wrought copper fittings, ASME B16.18 or ASME B16.22. Pre-formed grooves with pre-lubricated EPDM O-rings designed to seal fitting to copper tubing water tight with the use of manufacturer's crimping tool. Fittings shall be rated for 250 Degrees F., and 200 psi.
3. IAPMO UPC listing.
4. Manufacturer: Viega ProPress, NIBCO Press System, no substitutions.

C. Polypropylene Pipe and Fittings:

1. Random Copolymer Polypropylene (PP-RCT) manufactured from beta crystalline resin with fiberglass middle layer meeting ASTM F 2389. Pipe and fittings made from a PP-RCT (PPRP) material that is made from a terpolymer or made from standard PPR material are unacceptable. All pipe and fitting material shall be pigmented as solid steel grey in color, except for any outside UV protective layer, which may be black or white.
2. Provide SDR 11 piping.
3. Socket fusion, butt fusion, or electrofusion style fittings by the pipe manufacturer. Provide 316 stainless steel nuts, bolts and washers at all flanged connections.
4. Protect the piping from UV exposure while stored as recommended by the manufacturer.
5. For piping installed above the roof level, provide factory applied, UV resistant coating; Niron Neo.
6. Maximum operating temperature: 203 degrees F.
7. Pressure Rating: 75 PSIG at 203 degrees F.
8. Pipe and fittings warranted for 30 years from defects in materials or manufacturing.
9. Manufacturer: Nupi Niron Clima PP-RCT or approved equal.

2.2 VALVES

- A. Select valves of the best quality and type suited for the specific service and piping system used. Minimum working pressure rating 125 PSIG saturated steam or 200 PSIG WOG. Packing material or seals shall not contain asbestos.
- B. Manufacturers: Crane, Nibco, Hammond, Jenkins, Grinnell, Milwaukee, Stockham.
- C. Ball Valves 2 inch and smaller: Two piece type, full port, bronze body and silicone bronze ball or chrome plated brass ball, TFE seats, blowout proof stem, 150 PSIG pressure/temperature rating (steam).
 - A. Ball Valves 2-1/2 inches through 4 inch: Two piece type, full port, bronze body and silicone bronze ball or chrome plated brass ball, TFE seats, 150 PSIG pressure/temperature rating (steam). May be substituted for gate valves except where otherwise indicated.
 - B. Gate Valves, two inch and smaller: Bronze body and trim, rising stem, solid wedge. Use only where shown on drawings.
 - C. Gate Valves, 2-1/2 inch through four inch: Iron-body, bronze trim, flanged, threaded, or sweat fitting. Non-rising stem: Inside screw. Rising stem: OS&Y. Bronze valves optional for 2-1/2 inch and three-inch.
 - D. Swing Check Valves two inch and smaller: Bronze body, horizontal swing, Y-pattern, Buna-N-disc for water, oil and gas. TFE disc for steam.

SECTION 232113 – HYDRONIC PIPING AND SPECIALTIES

- E. Swing Check Valves 2-1/2 inch and larger: Iron body, horizontal swing, bolted bonnet, renewable bronze seat and disc, flanged or grooved. Bronze valves optional for 2-1/2 inch and three-inch.
- F. Drain Valves: Full port ball valve with threaded hose adapter with bronze end cap. Do not use sillcocks or butterfly valves as drain valves.
- G. Valves Specified Elsewhere: Provide special valves such as motor-operated valves, relief valves, temperature regulating valves, etc., as specified under the individual system or as indicated on the drawings.

2.3 UNIONS (STANDARD)

- A. Steel Piping (Threaded):
 - 1. Class 150 (150 PSIG steam, 300 PSIG WOG) malleable iron, ground joint, ASME B1.20.1, ASME B16.39. McMaster-Carr.
 - 2. Where indicated: Class 250 malleable iron ground joint, copper or copper alloy seat. McMaster-Carr.
- B. Copper Piping (Sweat): Cast bronze, ASTM B584 Alloy C84400, copper to copper. Nibco No. 733.

2.4 DIELECTRIC ISOLATORS (ELECTRICALLY INSULATING)

- A. Provide dielectric unions for two inch pipe and smaller.
- B. Provide dielectric flanges for 2-1/2 inch pipe and larger.
- C. Insulating gaskets shall be suitable for fluid type, temperature and pressure.
- D. Galvanized pipe to copper: Brass threaded end and sweat copper end.
- E. Black steel to copper: Zinc plated steel threaded end and sweat copper end.
- F. Manufacturers: Capitol, EpcO, Control Plastics, Watts, or approved equal.

2.5 PRESSURE GAUGES

- A. Provide where shown on drawings, specified in Part 3, or as required.
- B. Bourdon tube type with 4-1/2-inch dial (minimum) accuracy plus or minus one-percent span, recalibratable. Normal operating pressure near midpoint of range. Industrial quality.
- C. Gauge cock on gauges and pulsation damper (snubber). Steam gauges shall have siphon to isolate gauge from steam, except where remotely mounted and connected by looped tubing.
- D. Differential pressure gauges shall be piston or diaphragm type with range suitable for application and static pressure capability suitable for system pressure. Orange Research.

SECTION 232113 – HYDRONIC PIPING AND SPECIALTIES

2.6 THERMOMETERS

- A. Provide where shown on drawings, specified in Part 3, or as required.
- B. Liquid in glass type: Industrial quality blue-reading with nine-inch scale length (minimum). Straight angle or adjustable as necessary for visibility. Trerice, Marsh, Weksler, or approved equal.
- C. Dial Type: Industrial quality three-inch dial with a 270 degrees (minimum) scale. Straight, angle or remote as necessary for visibility. Trerice, Marsh, Weksler, or approved equal.
- D. Digital, self-powered type: Weiss DVU or equal.
- E. Normal operating temperature at scale midpoint and sufficient range to cover operating conditions.
- F. Provide separable wells of suitable material for piping and mounting hardware for ducts. Set probe in heat transfer paste recommended by thermometer manufacturer.

2.7 PRESSURE AND TEMPERATURE TEST PLUGS

- A. Provide where shown on drawings, specified in Part 3 or as required.
- B. Standard type for 1/8-inch diameter pressure or temperature probes. Self seal when probe removed and complete with threaded cap. Minimum continuous rating 125 PSIG and 220 degrees F coincident. Sealing element suitable for fluid in pipe.
- C. Provide one thermometer and one pressure gauge for each range required by system parameters.
- D. Manufacturers: Sisco, Peterson Equipment, or approved equal.

2.8 FLEXIBLE PIPE CONNECTORS

- A. General:
 - 1. System Application: Hot water heating or 50 percent propylene glycol solution (heating) or 30 percent propylene glycol solution (cooling).
 - 2. System Maximum Operating Temperature: 210 degrees F.
 - 3. Pressure: Internal.
 - 4. Installation: Straight or Offset as shown.
 - 5. Movement: Constant or Intermittent.
 - 6. Maximum offset: Not to exceed 25 percent of the centerline bend radius.
 - 7. Determine appropriate minimum “live hose length” (flexible portion of assembly) based on the centerline bend radius for each application in accordance with manufacturer’s sizing tables.
- B. Copper Pipe Flexible Connectors - Small Diameter (Sweat):
 - 1. Size: 3/4 inch through 2-1/2 inch nominal pipe size (NPS).

SECTION 232113 – HYDRONIC PIPING AND SPECIALTIES

2. Pipe Ends: Copper tube sweat.
3. Corrugated Hose: Bronze.
4. Outer Braid: Single braided bronze.
5. Minimum Working Pressure Rating: 120 PSIG at 250 degrees F.
6. Maximum Temperature Rating: 250 degrees F.

C. Copper Pipe Flexible Connectors - Small Diameter (Removable):

1. Size: 3/4 inch through 2-1/2 inch nominal pipe size (NPS).
2. Pipe Ends: Female pipe coupling, Female union, Male Hex Nipple, Male Pipe with Hex Nut.
3. Corrugated Hose: Bronze.
4. Outer Braid: Single braided bronze.
5. Minimum Working Pressure Rating: 120 PSIG at 250 degrees F.
6. Maximum Temperature Rating: 250 degrees F.

D. Steel Pipe Flexible Connectors - Small Diameter (welded):

1. Size: 3/4 inch through 2-1/2 inch nominal pipe size (NPS).
2. Pipe Ends: Weld nipple.
3. Corrugated Hose: Bronze.
4. Outer Braid: Single braided bronze.
5. Minimum Working Pressure Rating: 300 PSIG at 250 degrees F.
6. Maximum Temperature Rating: 250 degrees F.

E. Steel Pipe Flexible Connectors - Small Diameter (Removable):

1. Size: 3/4 inch through 2-1/2 inch nominal pipe size (NPS).
2. Pipe Ends: Schedule 40 steel with male pipe thread (MPT).
3. Corrugated Hose: Bronze.
4. Outer Braid: Single braided bronze.
5. Minimum Working Pressure Rating: 300 PSIG at 250 degrees F.
6. Maximum Temperature Rating: 250 degrees F.

F. Steel Pipe Flexible Connectors - Large Diameter:

1. Size: 3 inch through 10 inch nominal pipe size (NPS).
2. Pipe Ends: 150 LB plate steel flat faced flange.
3. Corrugated Hose: Type 304 stainless steel.
4. Outer Braid: Single braided Type 304 stainless steel.
5. Minimum Working Pressure Rating: 150 PSIG at 250 degrees F.
6. Maximum Temperature Rating: 250 degrees F.

G. Manufacturers: Metraflex, Keflex, or equal.

2.9 FLEXIBLE EXPANSION LOOP

- A. Provide flexible expansion loops of size and type noted on drawings.

SECTION 232113 – HYDRONIC PIPING AND SPECIALTIES

- B. Flexible loops shall consist of two flexible sections of hose and braid, two 90 degree elbows, and a 180 degree return assembled in such a way that the piping does not change direction, but maintains its course along a single axis. Loops shall have a factory supplied, center support nut located at the bottom of the 180 degree return, and a drain/air release plug. They shall impart no thrust loads to system support anchors or building structure.
- C. Materials of construction and end fitting type shall be consistent with pipe material and equipment/ pipe connection fittings.
- D. Manufacturer: Metraflex Metraloop or equal.

2.10 ACCESSORIES

- A. Pipe Alignment Guides:
 - 1. Two piece welded steel with enamel paint, bolted, with spider to fit standard pipe, frame with four mounting holes, clearance for minimum one inch thick insulation, minimum three inches travel.
 - 2. Manufacturers:
 - a. Metraflex
 - b. Approved equal

2.11 AIR VENTS

- A. Coin operated vent: Manual low profile vent for use in baseboard and other enclosures where automatic vent will not fit. 150 PSIG working pressure, 212 degrees F. operating temperature. Bell & Gossett No. 4V or approved equal.
- B. Float Type:
 - 1. Brass or semi-steel body, copper, polypropylene, or solid non-metallic float, stainless steel valve and valve seat; suitable for system operating temperature and pressure; with isolating valve.
 - 2. Iron body and cover, float, bronze pilot valve mechanism suitable for system operating temperature and pressure; with isolating valve.
 - 3. Operating pressure 75 PSIG, hydrostatic pressure 200 PSI maximum, intended for use in hot or cold lines. Provide ball type isolation valves for air vents that do not have integral shut off valves.
 - 4. Manufacturers: Spirotherm Spirotop, Honeywell EA791004, or equal.
- C. Disc Type:
 - 1. Designed to be replaced without removal from line, with built-in check valve.
 - 2. Limited to baseboard, unit ventilators, cabinet unit heaters, convectors, and elsewhere where air vent must be installed in a cabinet or enclosure, unless other type detailed on drawings.
 - 3. Maximum working pressure: 50 PSIG.
 - 4. Manufacturer: Hoffman No. 500, or equal.

SECTION 232113 – HYDRONIC PIPING AND SPECIALTIES

2.12 STRAINERS

- A. Size two inch and under:
 - 1. Screwed brass or iron body for 175 PSIG working pressure.
 - 2. Y pattern with 1/32-inch stainless steel perforated screen.
- B. Size 2-1/2 inches to four inches:
 - 1. Flanged or grooved iron body for 175 PSIG working pressure.
 - 2. Y pattern with 3/64-inch stainless steel perforated screen.
- C. Size five inches and larger:
 - 1. Flanged or grooved iron body for 175 PSIG working pressure.
 - 2. Basket pattern with 1/8-inch stainless steel perforated screen.
- D. Manufacturers: Metraflex, Armstrong, Crane, Hayward, Watts Regulator, Hoffman, Sarco, Victaulic.

2.13 AUTOMATIC FLOW LIMITING AND ISOLATION VALVES

- A. Supply pipe side: Brass alloy body with stainless steel flow cartridge assembly, integral ball valve, 20 mesh strainer element, two pressure/temperature test valves and drain valve with hose bibb adapter and end cap. Body design allows removal of flow cartridge without disturbing piping connections. Threaded sweat adapter inlet. Union with sweat adapter outlet.
- B. Return pipe side: Forged brass body with integral ball valve, pressure/temperature test valve and manual air vent. Union with sweat adapter inlet. Threaded sweat adapter outlet.
- C. Calibration: Control flow within five percent of selected rating, over operating pressure range of at least 10 times minimum pressure required for control. Provide three operating pressure ranges with a minimum range requiring less than 3.5 PSID to actuate flow control cartridge.
- D. Flow Control Cartridge: Stainless steel one piece cartridge with segmented port design and full travel linear coil spring.
- E. Provide supply and return components packaged as a system and labeled in accordance with the equipment schedule tag to match terminal heating unit served.
- F. Manufacturer: Griswold Controls, Bell & Gossett, or approved equal.

2.14 FLUSHING AGENT

- A. Synthetic organic dispersant manufacturer: CH₂O, Product 6149 or approved equal.

SECTION 232113 – HYDRONIC PIPING AND SPECIALTIES

2.15 WATER TREATMENT

- A. Hydronic loop treatment manufacturer: CH₂O, Product 6439 or approved equal.

2.16 GLYCOL SYSTEMS

- A. Provide equipment and products specifically designed and approved for continuous operation with the glycol solution specified.
- B. Glycol Solution:
 - 1. Inhibited propylene glycol solution premixed to 35 percent by volume for use with hydronic heating systems.
 - 2. Fluid analysis test kit.
 - 3. Manufacturer: Dow Chemical Company Dowfrost. No substitutes.

PART 3 - EXECUTION

3.1 INSTALLERS

- A. Installer: Perform work by experienced personnel previously engaged in hydronic system construction and under the supervision of a qualified installation supervisor.

3.2 PREPARATION

- A. Protection of In-Place Conditions: Cover equipment and plug piping connections to protect components from construction dirt and debris.
- B. Surface Preparation:
 - 1. Prior to installation of equipment, verify concrete housekeeping pads are complete and properly sized for equipment mounting.
 - 2. Prior to installation of piping and equipment, verify that shop drawings are approved, and locations and routing have been coordinated with the work of other trades.

3.3 INSTALLATION

- A. Special Techniques:
 - 1. Install equipment in accordance with manufacturer's instructions and requirements of the codes specified herein.
 - 2. Provide finished products with protective covers during balance of construction.
 - 3. Provide accessible ball type isolation valves at major piping branches, and on main lines as shown, and at terminal devices. Provide drains and manual vents at main line and branch line valves to facilitate draining and filling piping sections. Provide caps on drain outlets.
 - 4. Access Doors: Provide appropriate size and install such that hydronic system features are readily accessible and maintainable.

SECTION 232113 – HYDRONIC PIPING AND SPECIALTIES

5. Install balancing valves and automatic flow limiting valves to be accessible and adjustable.
 6. Install piping to maintain headroom, conserve space, and not interfere with use of space.
 7. Use of bullhead tee with opposed flow, double inlet configuration not allowed.
 8. Provide clearance in hangers and from structure and other equipment for installation of insulation and access to valves and fittings.
 9. Where pipe support members are welded to structural building framing, scrape, brush clean, and apply one coat of zinc rich primer to welding.
 10. Prepare exposed, unfinished pipe, fittings, supports, and accessories ready for finish painting. Refer to Division 9 - Finishes.
 11. Thermal Expansion:
 - a. Install piping to allow for normal thermal expansion and contraction without stressing pipe, joints, or connected equipment.
 - b. Provide anchors where necessary and as shown.
 - c. Provide support and expansion loops, expansion compensators, and alignment guides to suit conditions and as shown on drawings.
 - d. Piping shall be guided and restrained as recommended by the manufacturer.
 12. Provide test plugs on both inlet and outlet sides of heat transfer elements to allow measurement of both fluid pressure drop and differential temperature.
 13. Install flexible pipe connectors on pipes connected to equipment supported by vibration isolation. Provide line size flexible connectors.
 14. Install flexible connectors at right angles to displacement. Install one end immediately adjacent to isolated equipment and anchor the other end. Install in horizontal plane unless indicated otherwise.
 15. Provide pipe anchors, offsets, loops and expansion compensators as required to control the expansion of pipelines.
 16. Flushing:
 - a. Where hydronic piping installed under this project is connected to an existing hydronic system, provide branch isolation valves and provision for cleaning and flushing consisting of tees with valve, hose fittings and caps immediately adjacent to the branch isolation valves.
 - b. Clean internal surfaces of the completed heating system as follows:
 - 1). Flush hydronic piping to remove black magnetic iron oxide and mill scale from the system.
 - 2). Flush system piping with synthetic organic dispersant to remove grease. Circulate solution through system at 150 degrees F or greater for 12 to 24 hours.
 - 3). Repeat process until the system is clean to the satisfaction of the Contracting Agency.
 - 4). Flush system with fresh water as necessary to remove residual cleaning agent.
 - 5). Exercise proper care during flushing and cleaning of systems to make sure no damage is done to equipment, valves, fittings, or Work of other trades. Restore damaged system components or Work of other trades to new or original condition at no additional cost to Owner.
- B. Interface with Other Work: Coordinate and sequence installation of hydronic products with trades responsible for portions of this and other related sections of the Project Manual.

SECTION 232113 – HYDRONIC PIPING AND SPECIALTIES

3.4 REPAIR/RESTORATION

- A. Repair any product components broken during installation or startup with replacement parts supplied by the product manufacturer.
- B. Substitute replacement parts from other manufacturers are not acceptable.
- C. Touch-up finished surfaces with touch-up paint provided by the equipment manufacturer.

3.5 SITE QUALITY CONTROL

- A. Non-Conforming Work: Rework required as a result of failure to follow the manufacturer's written installation instructions or to properly coordinate with related Work shall be completed at no additional expense to the Owner.
- B. Manufacturer Services:
 - 1. Verify units are installed and operational in accordance with the manufacturer's written installation instructions.
 - 2. Both the Contractor and Manufacturer's Representative(s) shall sign start-up and operational checklist to confirm proper unit installation and operation.
 - 3. Provide samples of the inhibited propylene glycol solution to the manufacturer for testing using the fluid analysis test kit provided.
 - 4. The manufacturer of the inhibited propylene glycol solution shall provide free testing of the solution 24 hours after system startup and again 90 days later to verify proper fluid performance for both tests.
 - 5. Provide one copy of manufacturer's test reports to the Owner. Adjust fluid concentration and/or correct deficiencies as addressed in the report.
- C. Hydronic System Cleaning and Treatment Coordination Meeting:
 - 1. Conduct a meeting prior to flush cleaning and treatment of the hydronic heating and cooling systems to discuss cleaning agents, treatment chemicals and procedures to be used. Discuss system fill procedures with inhibited propylene glycol solution.
 - 2. Participants shall include the Contractor and Subcontractor directly performing the work and the Owner's Maintenance Staff personnel.
 - 3. Provide one week notice prior to the meeting.
 - 4. Cleaning, filling and treatment of any hydronic system is not permitted until this coordination meeting has been conducted and the Contracting Agency's concerns have been adequately addressed.
- D. System fill:
 - 1. After flush cleaning the hydronic cooling system, fill the system with inhibited propylene glycol solution as specified.
 - 2. Thoroughly vent the systems to include piping high points and equipment vents (pump casings, air separators, etc.).
- E. Site Tests:

SECTION 232113 – HYDRONIC PIPING AND SPECIALTIES

1. Hydrostatic Pressure Test:
 - a. Make sure hydronic heating and cooling systems are filled with clean operating fluid. Hydrostatically test system to 100 PSIG. System must hold test pressure for a two hour period with no pressure drop to pass test.
 - b. Inspect system during test and repair leaks.
 - c. Provide written report indicating that the pressure test has been satisfactorily completed.
2. Operational Test:
 - a. Inspect system for proper fluid circulation, sufficient clearance for expansion and contraction of piping and proper system pressure control.
 - b. Note and correct discrepancies and deficiencies.
 - c. Provide written report indicating that the operational test has been satisfactorily completed.
3. Test results shall be certified in writing as required by General Conditions. Include dates and sections tested, test pressure, test duration, printed names and signatures of person performing the test and Contracting Agency witnessing the test.

F. Inspection:

1. Arrange for inspections and provide written notice to the Contracting Agency when the entire work or logical portions thereof, is ready for inspection.

G. Verify penetrations are installed to maintain assembly integrity.

3.6 SYSTEM STARTUP

- A. Start-up and operate hydronic heating systems and equipment in accordance with the manufacturer's written installation and operation manual checklist.
- B. Document start-up and operational checks using the checklist and submit in accordance with submittal requirements.

3.7 ADJUSTING

- A. Adjust functional components for proper operation in accordance with manufacturer's recommendations, or as otherwise directed.
- B. Coordinate and work directly with the Balancing and Testing Agency and the requirements of Section 230593 - Testing, Adjusting and Balancing, to provide systems in proper operating order.
- C. Make corrections and adjustments as required by the Testing, Adjusting and Balancing (TAB) Agency in a timely manner.

SECTION 232113 – HYDRONIC PIPING AND SPECIALTIES

3.8 CLEANING

- A. Waste Management: After construction is completed, clean and wipe down exposed surfaces of pumps, piping and appurtenances.

3.9 CLOSEOUT ACTIVITIES

- A. Demonstration: Provide 2 hours of demonstration conducted by authorized factory start-up personnel to the Contracting Agencies authorized maintenance personnel.
- B. Training: Provide 4 hours of operational instruction conducted by authorized factory start-up personnel to the Contracting Agencies authorized maintenance personnel.

END OF SECTION 232113

SECTION 232113 – HYDRONIC PIPING AND SPECIALTIES

THIS PAGE INTENTIONALLY LEFT BLANK

SECTION 233100 – DUCTS AND ACCESSORIES

PART 1 - GENERAL

1.1 SUMMARY

- A. Section Includes: Metal Ductwork and Fittings.
 - 2. Flexible Ductwork.
 - 3. Volume Dampers.
 - 4. Fire Dampers.
 - 5. Access Panels and Doors.

- B. Related Sections:
 - 1. 200000 - Mechanical General Requirements
 - 2. 200529 - Mechanical Hangers and Supports
 - 3. 200700 - Mechanical Insulation
 - 4. 230593 - Testing, Adjusting and Balancing
 - 5. 233700 - Air Outlets and Inlets

1.2 REFERENCES

- A. Codes and Standards:
 - 1. See section 200000 - Mechanical General Requirements.
 - 2. ASHRAE Standard 90.1-2010 Energy Standard for Buildings Except Low-Rise Residential Buildings.
 - 3. SMACNA HVAC Duct Construction Standards - Metal and Flexible, Third Edition 2005.
 - 4. SMACNA HVAC Air Duct Leakage Test Manual, Second Edition 2012.
 - 5. SMACNA Fire, Smoke and Radiation Damper Installation Guide for HVAC Systems, Fifth Edition 2002.
 - 6. NFPA 90A - Installation of Air-Conditioning and Ventilating Systems.
 - 7. ACR the National Air Duct Cleaners Association (NADCA) Standard for Assessment, Cleaning and Restoration of HVAC Systems, 2013.

1.3 PRE-INSTALLATION MEETINGS

- A. See section 200000 - Mechanical General Requirements.

1.4 SUBMITTALS

- A. See section 200000 - Mechanical General Requirements for general submittal requirements for the items listed below, supplemented with the additional requirements listed.

- B. Product Data: Include manufacturer's detailed fire, smoke, and combination fire/smoke damper installation instructions for each specific wall, ceiling, and floor construction type(s) for the project.

SECTION 233100 – DUCTS AND ACCESSORIES

C. Shop Drawings:

1. Include the following information in the scaled ventilation system shop drawings:
 - a. Label duct sizes using the same labeling method as the Contract Documents.
 - b. Show terminal equipment ductwork connections.
 - c. Volume and control damper locations as applicable.
 - d. Access panels and doors with sizes and swing directions shown.

D. Test and Evaluation Reports:

1. Provide written certification to the Contracting Agency that smoke and combination fire/smoke dampers have been operationally tested and function in accordance with Section 28 3100 - Addressable Fire Alarm System sequences of operation.
2. Submit recorded kitchen exhaust system test information; see Part 3 - Site Tests and Inspections.

E. Installation, Operation and Maintenance (IO&M) Manuals.

1.5 CLOSEOUT SUBMITTALS

- A. See section 200000 - Mechanical General Requirements.
- B. Record Documentation: Record actual locations of ductwork and areas required for maintenance access in accordance with Section 200000 - Mechanical General Requirements.

1.6 QUALITY ASSURANCE

- A. See section 200000 - Mechanical General Requirements.

1.7 DELIVERY, STORAGE, AND HANDLING

- A. See section 200000 - Mechanical General Requirements.

1.8 WARRANTY

- A. Manufacturer Warranty: See section 200000 - Mechanical General Requirements, for general mechanical warranty requirements.

PART 2 - PRODUCTS

2.1 METAL DUCTWORK AND FITTINGS

- A. General: Provide metal ductwork and fittings fabricated in accordance with SMACNA HVAC Duct Construction Standards - Metal and Flexible, G90 zinc coated unless otherwise noted.
- B. Medium Pressure/Velocity Ductwork:

SECTION 233100 – DUCTS AND ACCESSORIES

- 1. Duct Pressure Class: 4 inches WC.
- 2. Seal Class: A.
- 3. Maximum Velocity: 2,200 FPM.

C. Low Pressure/Velocity Ductwork:

- 1. Duct Pressure Class: 2 inches WC.
- 2. Seal Class: A.
- 3. Maximum Velocity: 1,500 FPM.

2.2 FLEXIBLE DUCTWORK

A. Manufacturers:

- 1. Thermaflex, Model M-KE.
- 2. Hart & Cooley.
- 3. JPL.
- 4. Any other manufacturer meeting the requirements of the Contract Documents. Substitution request not required.

B. Description: UL listed, Class 1 flexible ductwork in compliance with NFPA 90A and 90B.

C. Performance/Design Criteria:

1. Positive Pressure Rating:

Ten inches WC	(4"-12" ID).
Six inches WC	(14"-16" ID).
Four inches WC	(18"-20" ID).

2. Negative Pressure Rating:

One inch WC	(4"-12" ID).
One half inch WC	(14"-20" ID).

- 3. Maximum Velocity: 5000 FPM.
- 4. Operating Temperature Range:
 - a. 0 degrees F to 140 degrees F (continuous).
 - b. Minus 20 degrees F to 250 degrees F (intermittent).
- 5. Insulating Value: R-4.2.

D. Materials:

- 1. Acoustically rated black polyester core permanently bonded to coated spring steel wire helix.
- 2. Fiberglass insulation.
- 3. Tear resistant, reinforced metalized vapor barrier.

SECTION 233100 – DUCTS AND ACCESSORIES

2.3 VOLUME / BALANCING DAMPERS

A. Manufacturers:

1. Ruskin.
2. Greenheck.
3. Any other manufacturer meeting the requirements of the Contract Documents. Substitution request not required.

B. Materials:

1. Refer to SMACNA HVAC Duct Construction Standards - Metal and Flexible for fabricated volume damper construction requirements.
2. Round ducts to 12 inches diameter and rectangular to 18 inches width:
 - a. Flat sheet, galvanized steel, single blade damper.
 - b. Damper blade two gauges thicker than the duct gauge at the location installed (24 gauge minimum for round, 22 gauge minimum for rectangular).
 - c. Manual hand quadrant.
3. Round ducts over 12 inches diameter:
 - a. Flat sheet, galvanized steel, single blade damper.
 - b. Damper blade two gauges thicker than the duct gauge at the location installed (22 gauge minimum).
 - c. Manual hand quadrant with continuous steel rod.
4. Rectangular ducts over 18 inches width:
 - a. Flat sheet, galvanized steel, single blade damper.
 - b. Damper blade 18 gauge minimum.
 - c. Manual hand quadrant with continuous steel rod.
5. Accessible and lockable damper operators.

C. Extractors: Not Permitted.

D. Splitter Dampers: Not Permitted.

2.4 REMOTE VOLUME DAMPER OPERATORS

A. Manufacturers:

1. Duro-dyne.
2. Young Regulator.
3. Any other manufacturer meeting the requirements of the Contract Documents. Substitution request not required.

B. Provide flush mounted chrome plated remote operators with tamperproof cover, extension rod, and not more than one 90 degree angle gear drive.

C. Regulator: Duro-dyne Series SRC-380 or Young Regulator 301.

SECTION 233100 – DUCTS AND ACCESSORIES

- D. Angle Drive: Duro-dyne Model AD-38 or Young Regulator 927.

2.5 FIRE DAMPERS

A. Manufacturers:

1. Ruskin (Basis of Design).
2. Greenheck.
3. Pottorff.
4. Any other manufacturer meeting the requirements of the Contract Documents. Substitution request not required.

B. Regulatory Requirements: UL listed and labeled in accordance with UL Standard 555.

C. Performance/Design Criteria:

1. Fire rating suitable for the applicable wall construction rating in accordance with IBC.
2. Rated for use in dynamic system with maximum velocity of 2,000 FPM and maximum 4 inches WC static pressure.
3. Provide with 165 degrees F fuse link.

2.6 ACCESS PANELS AND DOORS FOR DUCTS AND PLENUMS

A. Manufacturers:

1. Air Balance Inc. model FSA-100 (Basis of Design).
2. Ruskin.
3. Ductmate.
4. Any other manufacturer meeting the requirements of the Contract Documents. Substitution request not required.

B. Material:

1. Frame and Door: Minimum 24 gauge galvanized steel.
2. Reinforced doors with cross-bracing and/or otherwise stiffened to prevent rattling and vibration.
3. Seals: Rubber gaskets, secured to door or frame.
4. Where ductwork is insulated or lined, provide double-walled access door panels with one inch of internal insulation to match duct or plenum insulating and/or sound attenuating characteristics.
5. Walk Through Doors:
 - a. Construct in accordance with SMACNA HVAC Duct Construction Standards - Metal and Flexible.
 - b. Provide insulation and inner liner to match plenum or casing.

C. Hinges and Latches:

1. Low velocity system access panels:
 - a. Sizes 12 inches by 12 inches through 24 inches by 24 inches.

SECTION 233100 – DUCTS AND ACCESSORIES

- b. Continuous steel hinge mechanically fastened to frame and quarter turn cam latches.
- 2. Medium velocity system access panels:
 - a. Sizes 12 inches by 12 inches through 24 inches by 24 inches.
 - b. Continuous steel hinge mechanically fastened to frame.
 - c. Provide a minimum of two latches for rolled plate doors.
 - d. Cement sheet rubber gasket to door.
- 3. Walk through doors (any dimension over 24 inches):
 - a. Provide three hinges.
 - b. Provide two latches with inside and outside handles.

PART 3 - EXECUTION

3.1 EXAMINATION

- A. Verify location, size and type (i.e. fire resistive construction) of wall, floor and ceiling/roof penetrations.

3.2 PREPARATION

- A. Protection on In-Place Conditions: During construction, install temporary closures of sheet metal, cardboard or polyethylene taped over ductwork openings to prevent construction dust and debris from entering duct systems.

3.3 INSTALLATION

- A. Metal Ductwork and Fittings:
 - 1. Install, seal and support ductwork and fittings in accordance with SMACNA HVAC Duct Construction Standards - Metal and Flexible for the duct pressure class and seal class specified. The use of “duct tape” as a duct seal method is prohibited.
 - 2. Provide medium pressure/velocity ductwork at the following locations: VAV ventilation systems from air handler cabinet discharge plenum connection to VAV terminal unit inlet neck connection.
 - 3. Provide low pressure/velocity ductwork at the following locations:
 - a. VAV terminal unit discharge connections to air outlet connections.
 - b. Outside air intake ductwork.
 - c. Exhaust and relief air ductwork.
 - d. Constant volume ventilating systems.
 - 4. Proprietary or other joint systems may be substituted for SMACNA details when submitted and approved in writing before starting work.
 - 5. Where ducts penetrate through walls exposed in occupied spaces, provide sheet metal escutcheons at each penetration to provide a clean, finished appearance.
 - 6. Duct penetrations: See Section 200529 - Mechanical Hangers and Supports.
 - 7. Provide standard 45-degree lateral wye takeoffs. When space does not allow 45-degree lateral wye takeoffs, use 90-degree conical tee or low-loss tee connections.

SECTION 233100 – DUCTS AND ACCESSORIES

8. Increase duct sizes gradually, not exceeding 15 degrees divergence wherever possible; maximum 30 degrees divergence upstream of equipment and 45 degrees convergence downstream of equipment.
9. Provide orifice plates or balance dampers at branch connections as required for proper ventilation system balancing. Select balancing device and installation method to limit noise from mechanical vibration or air bypass.
10. Do not use turning vanes in medium velocity duct systems.
11. Support duct mounted equipment equal to or greater than 40 pounds, such as heating coils, independently from ductwork.
12. Support duct mounted equipment less than 40 pounds using standard duct supports and sway bracing located within 12 inches of equipment.
13. Where offsetting ductwork is not possible, ducts may be reduced a maximum of 20 percent to clear obstacles with Contracting Agency's permission.
14. Where steel ductwork is visible through air outlets or inlets, paint visible interior ductwork flat black.

B. Flexible Ductwork:

1. Install, connect and support flexible ductwork in accordance with SMACNA HVAC Duct Construction Standards - Metal and Flexible.
2. Connection to air outlets in suspended grid ceiling systems: Provide a flexible duct length of 6 to 8 feet with one 90-degree bend or large radius 180-degree curve in addition to outlet connection. Support flexible duct at connections to air outlets to maintain minimum recommended bend radius.
3. Seal flexible duct connections to rigid ductwork with draw bands to the pressure class of the rigid duct system.
4. Flexible duct connections between medium pressure ductwork and air terminal units are prohibited.
5. Flexible ductwork is prohibited in inaccessible locations, such as above "hard" ceilings.
6. Flexible ductwork is prohibited at penetrations through walls.

C. Volume Dampers:

1. Provide air volume dampers at each low-pressure duct main and branch take-off for proper air balancing.
2. Locate dampers a minimum of 10 feet from diffusers except where shown otherwise.
3. Volume dampers are not to be installed in medium pressure, variable air volume systems.

D. Fire Dampers:

1. Before starting work, verify the location and types of fire resistive construction as indicated by the Contract Drawings. Typical fire rated separations include:
 - a. Area separation walls, vertical only.
 - b. Occupancy separation walls, or partitions and floors. Vertical or horizontal.
 - c. Fire resistive egress corridors, halls and vestibules.
 - d. Fire resistive enclosures of hazardous spaces within an occupancy, including rooms for fuel-fired or electric heating equipment.
 - e. Fire resistive floor/ceiling assemblies associated with any of the above.
2. Verify locations and types of dampers indicated on drawings. If dampers appear to be incorrectly located or missing, obtain clarification from Contracting Agency.

SECTION 233100 – DUCTS AND ACCESSORIES

3. Install dampers at locations indicated on the Drawings and in accordance with manufacturer's UL approved installation instructions.
4. Install round dampers plumb and free from racking. Install rectangular dampers square and free from racking.
5. Do not compress or stretch damper sleeve into duct or opening.
6. Handle damper using frame/sleeve. Do not lift damper using blade, actuator, or jackshaft.

E. Penetrations:

1. Coordinate mechanical penetrations with architectural and structural construction details prior to installation. Set sleeves in position in concrete formwork. Provide reinforcement around sleeves as required.
2. Provide compatible materials, fasteners, adhesives, sealants, and other products required for proper installation.
3. Penetrations through roof, exterior walls and floors to be weather and water tight.
4. Penetrations through fire rated assemblies to be UL listed.
5. Penetrations through smoke partitions and barriers to resist passage of smoke.
6. Other penetrations to have acoustical seals.

F. Access Panels and Doors:

1. Locate access doors to enable in-duct equipment to be easily inspected, cleaned, maintained and tested and/or reset.
2. Provide access doors at the following locations:
 - a. Fire, smoke and combination fire/smoke dampers.
 - b. Motor operated dampers.
 - c. Each side of duct mounted coils.
 - d. Each side of duct mounted humidification dispersion panels.
 - e. As necessary for duct cleaning in accordance with NADCA Industry Standard for Mechanical Cleaning of Non-Porous Air Conveyance System Components.
 - f. As necessary for maintenance access to serviceable instrumentation and control equipment.
3. Coordinate location and size of access doors in walls, partitions and ceilings to correspond with duct access doors, dampers and automatic control devices and instruments.
4. Coordinate with supplier of component air handlers, package units and similar equipment to ensure that access doors and panels will not be obstructed when the equipment is installed.

G. Interface with Other Work:

1. Assist electrical and controls trades in mounting instrumentation devices and safety controls in ductwork and air handling units.
2. Make penetrations through exterior building walls watertight. Detail ductwork connections to prevent condensation or leakage from entering into surrounding building construction. Provide sleeves, special connections and sealant as required to accomplish this performance requirement.

SECTION 233100 – DUCTS AND ACCESSORIES

3.4 SITE QUALITY CONTROL

- A. Verify accessibility to ventilation system components for maintenance, adjustment and cleaning.

3.5 ADJUSTING

- A. Adjust and balance dampers in accordance with Section 230593 - Testing. Adjusting and Balancing.

3.6 CLEANING

- A. Prior to building occupancy and after ventilating systems are complete and functional, verify cleanliness of ventilating system ductwork. Verification shall comply with the inspection method(s) outlined in the National Air Duct Cleaners Association (NADCA) Standard for Assessment, Cleaning, and Restoration of HVAC Systems 2013. Conduct inspection in the presence of a Contracting Agency representative.
- B. If the ductwork does not comply with the standard for cleanliness, clean the affected ductwork as follows:
 - 1. Small systems: Clean duct system and force air at high velocity through duct to remove accumulated dust. To obtain sufficient airflow, clean one half of system completely before proceeding to other half. Protect equipment with potential to be harmed by excessive dirt with temporary filters, or bypass during cleaning.
 - 2. Large systems: Clean duct systems with high power vacuum machines. Protect equipment with potential to be harmed by excessive dirt with filters, or bypass during cleaning.

END OF SECTION 233100

SECTION 233100 – DUCTS AND ACCESSORIES

THIS PAGE INTENTIONALLY LEFT BLANK

SECTION 233700 – AIR OUTLETS AND INLETS

PART 1 - GENERAL

1.1 SUMMARY

- A. Section Includes:
 - 1. Air Diffusers and Registers.
 - 2. Return/Exhaust Grilles.
- B. Related Sections:
 - 1. 200000 - Mechanical General Requirements
 - 2. 200529 - Mechanical Hangers and Supports
 - 3. 230593 - Testing, Adjusting and Balancing
 - 4. 233100 - Ducts and Accessories

1.2 REFERENCES

- A. Codes and Standards:
 - 1. See section 200000 - Mechanical General Requirements.
 - 2. SMACNA HVAC Duct Construction Standards - Metal and Flexible Fourth Edition 2021.
 - 3. NFPA 90A - Installation of Air Conditioning and Ventilation Systems.
 - 4. ARI Standard 890-2001 - Air Diffusers and Air Diffuser Assemblies.

1.3 SYSTEM DESCRIPTION

- A. Performance Requirements: Provide product performance characteristics as specified or scheduled on drawings.

1.4 PRE-INSTALLATION MEETINGS

- A. See section 200000 - Mechanical General Requirements.

1.5 SUBMITTALS:

- A. See section 200000 - Mechanical General Requirements for general submittal requirements for the items listed below, supplemented with the additional requirements listed.
- B. Product Data:
 - 1. Air outlets and inlets performance data at operating conditions.
- C. Shop Drawings:

SECTION 233700 – AIR OUTLETS AND INLETS

1. This Section shop drawings to be submitted under Section 200000 - Mechanical General Requirements.
2. Include the following information on scaled ventilation system shop drawings:
 - a. Air diffuser, register and grille locations, duct connection sizes and throw directions.

D. Installation, Operation and Maintenance (IO&M) Manuals.

1.6 CLOSEOUT SUBMITTALS:

A. See section 200000 - Mechanical General Requirements.

1.7 MAINTENANCE MATERIAL SUBMITTALS

A. See section 200000 - Mechanical General Requirements.

1.8 QUALITY ASSURANCE:

A. See section 200000 - Mechanical General Requirements.

1.9 DELIVERY, STORAGE AND HANDLING

A. See section 200000 - Mechanical General Requirements.

1.10 WARRANTY

A. Manufacturer Warranty: See section 200000 - Mechanical General Requirements, for general mechanical warranty requirements.

PART 2 - PRODUCTS

2.1 AIR DIFFUSERS AND REGISTERS

A. Manufacturers:

1. Titus (Basis of Design).
2. Price.
3. Nailor Industries Inc.
4. Any other manufacturer meeting the requirements of the Contract Documents. Substitution request not required.

B. Performance/Design Criteria: As scheduled.

C. Finishes: Standard white, baked enamel or powder coated finish suitable for field application of custom finish color as required.

SECTION 233700 – AIR OUTLETS AND INLETS

- D. Accessories:
 - 1. Equalizing grids.
 - 2. Earthquake tabs.
- E. Correlate diffuser style, dimension, and fit with ceiling. Provide diffusers with modules of the proper size to match the suspended ceiling layout or with appropriate factory provided frame for surface mounting.

2.2 RETURN/EXHAUST GRILLES

- A. Manufacturers:
 - 1. Titus (Basis of Design).
 - 2. Price.
 - 3. Nailor Industries Inc.
 - 4. Any other manufacturer meeting the requirements of the Contract Documents. Substitution request not required.
- B. Performance/Design Criteria: As scheduled.
- C. Finishes: Standard white, baked enamel or powder coated finish suitable for field application of custom finish color as required.
- D. Accessories: Earthquake tabs.
- E. Correlate grille style, dimension, and fit with ceiling. Provide grilles with modules of the proper size to match the suspended ceiling layout or with appropriate factory provided frame for surface mounting.

PART 3 - EXECUTION

3.1 PREPARATION

- A. Removal: Remove existing air diffusers, registers and grilles designated for relocation and reuse after repair and cleaning.

3.2 INSTALLATION

- A. General:
 - 1. Install products in compliance with the manufacturer's written installation instructions.
 - 2. Connect air outlets, registers, grilles and louvers to ventilation duct systems in accordance with SMACNA HVAC Duct Construction Standards - Metal and Flexible.
- B. Air Diffusers, Registers and Grilles:
 - 1. Install air diffusers, registers and return/exhaust grilles at the locations shown.

SECTION 233700 – AIR OUTLETS AND INLETS

2. Orient and adjust diffusers to provide the throw directions indicated.
3. Provide appropriate borders for the ceiling, wall or floor construction type.

3.3 REPAIR/RESTORATION

- A. Refer to Section 200000 - Mechanical General Requirements for general repair/restoration requirements.
- B. Clean and repair existing air outlets and inlets to function as originally intended prior to reinstallation. Air outlets and inlets which require major repair may be replaced at the Contractor's option.

3.4 CLEANING

- A. Clean exposed surfaces of air outlets and inlets, with water and mild soap or detergent not harmful to finish, in order to remove fingerprints and dirt.

END OF SECTION 233700

SECTION 236400 – PACKAGED WATER CHILLERS

PART 1 - GENERAL

1.1 SUMMARY

- A. Section includes: Design, performance criteria, refrigerants, compressor type(s), starter type(s), controls, and installation for packaged air-cooled chiller units.
- B. Related Sections:
 - 1. 20 0000 - Mechanical General Requirements
 - 2. 20 0553 - Mechanical Identification
 - 3. 20 0700 - Mechanical Insulation
 - 4. 23 0593 - Testing, Adjusting and Balancing
 - 5. 23 2113 - Hydronic Piping and Specialties
 - 6. 25 9000 - Sequence of Operations

1.2 REFERENCES

- A. Codes and Standards:
 - 1. See section 20 0000 - Mechanical General Requirements.
 - 2. AHRI 550/590 - Water Chilling Packages Using the Vapor Compression Cycle.
 - 3. AHRI 370 - Sound Rating of Large Outdoor Refrigerating and Air-Conditioning Equipment.
 - 4. ANSI/ASHRAE 15 - Safety Code for Mechanical Refrigeration.
 - 5. ANSI/ASHRAE 34 - Number Designation and Safety Classification of Refrigerants.
 - 6. ASHRAE 90.1 - Energy Standard for Buildings Except Low-Rise Residential Buildings.
 - 7. ASME Boiler and Pressure Vessel Code, Section VIII, Division 1.
 - 8. OSHA - Occupational Safety and Health Act.
 - 9. Manufactured in facility registered to ISO 9001.
 - 10. ANSI/ASHRAE 15 Safety Standard for Refrigeration Systems.
 - 11. ETL/cETL.

1.3 SYSTEM DESCRIPTION

- A. Design Requirements:
 - 1. Provide complete packaged air-cooled chiller units utilizing scroll compressor technology as scheduled, specified herein, and as shown on the Drawings.
 - 2. The unit shall be constructed and operate in accordance with the referenced design standards and with local Codes in effect.
- B. Performance Requirements:
 - 1. Refer to the schedule of performance on the Drawings.
 - 2. The unit shall be capable of stable operation to a minimum of approximately 15 percent of full load without hot gas bypass.

SECTION 236400 – PACKAGED WATER CHILLERS

3. Performance shall be in accordance with ARI Standard 365-94 and as indicated herein and on the drawings.

1.4 PRE-INSTALLATION MEETINGS

- A. See section 20 0000 - Mechanical General Requirements.

1.5 SUBMITTALS

- A. See section 20 0000 - Mechanical General Requirements for general submittal requirements for the items listed below, supplemented with the additional requirements listed.

- B. Product Data:

1. Include submittal information specific to the equipment specified by this section as follows:
 - a. Provide manufacturer's literature that fully demonstrates compliance with the manufacturing methods, appurtenances, and salient features specified.
 - b. Provide sound power level data (decibels) for each octave band for the equipment.
 - c. Provide electrical connection requirements.
 - d. Provide electrical power connection and control logic wiring diagrams. Diagrams shall differentiate between factory installed and field installed wiring.

- C. Substitutions:

1. Proposed substitutions shall meet:
 - a. Performance requirements as scheduled (as a minimum),
 - b. Unit size, weight, and electrical load limitations as required for this project,
 - c. The specification requirements of this section.
2. Specifically, substitution units shall be provided with (no exceptions):
 - a. Adjustable soft-start compressor starters,
 - b. An integral "Return Chilled Liquid Control" mode or a pre-approved master/slave central chilled water control plant function acceptable to the Owner.
3. Cost of design modifications as a result of proposed product substitutions shall be borne by the Contractor.

- D. Shop Drawings:

1. Provide dimensional and orientation information (plan and elevation) for the approved chiller and incorporate into the mechanical shop drawings.
2. Indicate overall dimensions, access door locations, and piping and electrical connection points.
3. Label chillers as scheduled.

- E. Operation and Maintenance (O&M) Manual:

SECTION 236400 – PACKAGED WATER CHILLERS

1. Provide a complete copy of the manufacturer's written installation, operation and maintenance manual to include the following information:
 - a. Manufacturer's descriptive literature.
 - b. Installation instructions.
 - c. Operating instructions.
 - d. Troubleshooting guide.
 - e. Preventative maintenance requirements.
 - f. Parts list.
 - g. Recommended spare parts list.
2. Neatly annotate the O&M manual to clearly indicate information applicable to the equipment installed.

F. Training and Demonstration:

1. Provide letter of certification showing system operation has been demonstrated and training has been accomplished.
2. Submit completed manufacturer's installation checklist.

1.6 CLOSEOUT SUBMITTALS

- A. See section 20 0000 - Mechanical General Requirements.
- B. Submit a certificate from the Manufacturer's Representative indicating that the chillers are installed and operational in accordance with the manufacturer's written installation, operation and maintenance manual and the specified sequences of operation.

1.7 MAINTENANCE MATERIAL SUBMITTALS

- A. See section 20 0000 - Mechanical General Requirements.

1.8 QUALITY ASSURANCE

- A. See section 20 0000 - Mechanical General Requirements.
- B. Regulatory requirements: Products requiring electrical connection shall be listed and classified by Underwriters Laboratories Incorporated, or by a testing firm acceptable to the Authority Having Jurisdiction.
- C. Factory Run Test: Chiller shall be pressure-tested, evacuated and fully charged with refrigerant and oil, and shall be factory operational run tested with water flowing through the vessel prior to shipment.
- D. Chiller manufacturer shall have a factory trained and supported service organization permanently based in the State of Alaska.

SECTION 236400 – PACKAGED WATER CHILLERS

1.9 DELIVERY AND HANDLING

- A. See section 20 0000 - Mechanical General Requirements.
- B. Unit shall be delivered to job site fully assembled with interconnecting refrigerant piping and internal wiring ready for field installation and charged with refrigerant and oil by the Manufacturer.
- C. Provide protective covering over vulnerable components for unit protection during shipment. Fit nozzles and open ends with plastic enclosures. See Accessories and Options section herein.

1.10 WARRANTY

- A. Manufacturer Warranty: See section 20 0000 - Mechanical General Requirements, for general mechanical warranty requirements.
- B. Manufacturer shall warrant equipment and material of its manufacture against defects in workmanship and material for a period of 18 months from date of shipment or 12 months from date of start-up, whichever occurs first.
- C. Provide optional 3-year parts only warranty for compressors. See Accessories and Options below.

PART 2 - PRODUCTS

2.1 ACCEPTABLE MANUFACTURERS

- A. Multistack (basis of design).
- B. York.
- C. McQuay.
- D. Trane.
- E. Pre-approved equal.

2.2 AIR COOLED SCROLL COMPRESSOR WATER CHILLER

- A. System Description: Chiller shall incorporate Scroll type compressors and can consist of multiple modules. Each refrigerant circuit shall consist of an individual compressor set, common dual circuit evaporator, dual circuited condenser, electronic expansion valves, liquid line solenoid valves, filter driers, fin and tube condenser, and control system. Each circuit shall be constructed to be independent of other circuits from a refrigeration and electrical stand-point. The multi-circuit chiller must be able to produce chilled water even in the event of a failure of one or more refrigerant circuits.
- B. General:

SECTION 236400 – PACKAGED WATER CHILLERS

1. Chiller Modules shall be ETL listed in accordance with UL Standard 1995, CSA certified per Standard C22.2#236.
 2. Chiller modules shall be AHRI certified.
 3. Modules shall ship wired and charged with refrigerant. All modules shall be factory run tested prior to shipment on an AHRI certified or 3rd party verified test stand.
 4. Compressors, heat exchangers, condenser fans, piping and controls shall be mounted on a heavy gauge, powder coated steel frame. Electrical controls, contactors, and relays for each module shall be mounted within that module. Module shall be provided within a steel enclosure suitable for outdoor use. Exposed steel surfaces shall be provided with a powder coat paint finish.
 5. Modules shall be IBC Certified per AC154. Proof of certification shall be furnished upon request.
- C. Operating Conditions:
1. Provide outdoor packaged air-cooled liquid chiller with the capacity as scheduled on drawings.
 2. Chiller shall be designed to operate using R-410A Refrigerant.
 3. Chiller shall be designed for parallel evaporator water flow.
 4. The liquid to be chilled will be water containing corrosion inhibitors and antifreeze solution as required.
- D. Evaporator: Each evaporator shall be a brazed plate heat exchanger constructed of 316 stainless steel; designed, tested, and stamped in accordance with UL 1995 code for 650 psig working pressure. The evaporator heat exchanger shall not be mounted above the compressor, to eliminate the effect of migration of refrigerant to the cold evaporator with consequent liquid slugging on start-up.
- E. Compressor: Each module shall contain two hermetic scroll compressors in a tandem piping arrangement mounted to the module with rubber-in-shear isolators. Each system to include high discharge pressure and low suction pressure safety cut-outs.
- F. Condenser Fans: Each module shall contain dual condenser fans for each refrigerant circuit. Fans shall be multi-blade vane-axial type made of plastic composite material. Fans shall be direct drive with variable frequency drives. Fan motors shall be pressure controlled and suitable for outdoor use.
- G. Controls:
1. Scheduling of the various compressors shall be performed by a microprocessor based control system. Compressors to be rotated to assure even distribution of compressor run time.
 2. The Controller shall monitor and report the following on each refrigeration system:
 - a. Discharge Pressure Fault
 - b. Suction Pressure Fault
 - c. Compressor Winding Temperature
 - d. Suction Temperature
 - e. Evaporator Leaving Chilled Water Temp.
 3. The Controller shall be powered by the chillers single point power connection and shall monitor and report the following system parameters:
 - a. Chilled Water Entering and Leaving Temperature

SECTION 236400 – PACKAGED WATER CHILLERS

- b. Discharge Refrigerant Temperature
 - c. Chilled Water Flow
4. Individual monitoring of leaving chilled water temperatures from each refrigeration system shall be programmed.
 5. The control system shall monitor entering and leaving chilled water temperatures to determine system load and select the number of compressor circuits required to operate. Response times and set points shall be adjustable. The system shall provide for variable time between compressor sequencing and temperature sensing, so as to optimize the chiller performance to different existing building loads.
 6. Building Automation System (BAS) Interface Controls: Chiller to have external inputs and outputs compatible with the building automation system to include remote start/stop capability and Cooling Alarm output.

H. Accessories and Options:

1. The following accessories and options supersede standard product features listed above. Provide:
 - a. Low Ambient to -20 degrees F: Chiller shall incorporate appropriate refrigerant specialties including a properly sized refrigerant receiver and flooded head pressure control valves for operation to -20 degrees F. This option includes VFD driven condenser fan motors.
 - b. Single Point Power Connection: Chiller shall be provided with a single point power connection at a 5,000 amp SCCR, including pre-engineered wiring for field installation and connection to factory mounted chiller junction box. Junction box shall include branch circuit protection for each module and provide a single point of connection to building power.
 - c. Free Cooling Module: Free cooling module shall interconnect through the common chiller header system and require no additional water connections. Free cooling module shall include glycol cooling coils, temperature controlled fans and an automatic 3-way bypass valve. Module shall be completely factory assembled and tested before shipment.
 - d. Pump Module with Expansion Tank and Glycol Feeder:
 - 1). Pump module shall be interconnected through the common chiller header system and require no additional water connections. Pump module shall incorporate dual in-line centrifugal pumps in a Primary/Standby pumping arrangement. Pump starters and controls shall be provided to enable manual selection of lead pump.
 - 2). Both the primary and secondary pumps to be provided with factory installed variable speed drives for flow balancing.
 - 3). Expansion tank shall be welded steel with butyl rubber diaphragm and capable of a maximum operating temperature of 240° F and maximum working pressure of 100 psig. Tank shall be interconnected through the common chiller header system and require no additional water connections.
 - 4). Glycol Feeder: 48-gallon storage/mixing tank with lid and cover; pump suction hose with inlet strainer; pressure pump with thermal cut-out, and integral pressure switch; pre-charged accumulator tank with EPDM diaphragm, manual diverter valve for purging and agitating contents of storage tank, adjustable 5-55 psi pressure regulating valve with pressure gauge, fast fill lever, integral replaceable strainer, built in check valve, and built in shut-off valve. Glycol

SECTION 236400 – PACKAGED WATER CHILLERS

- feeder system shall be compatible with glycol solutions of up to 50% concentration. Pump shall be capable of running dry without damage.
- 5). Module shall be completely factory assembled and tested prior to shipment.
 - e. Lifting Frame: Six (W6X15) inch I-beam painted steel frame with modules mounted upon it. Water and wiring connections will be made between the modules at the factory.
 - f. Corrosion Resistant Features:
 - 1). Unit exterior cabinet for all modules to be coated with PSX-700 (Ameron Siloxane) corrosion resistant finish.
 - 2). Condenser and free cooling coils to have electrofin epoxy coatings.
 - 3). Spray on bronzeglow coating for lower refrigeration components.
- I. Safeties, Controls, and Operation:
1. Chiller safety controls shall be provided as follows:
 - a. Low evaporator refrigerant pressure
 - b. Loss of water flow through the evaporator
 - c. High condenser refrigerant pressure
 - d. High compressor motor temperature
 - e. Low suction gas temperature
 - f. Low leaving evaporator water temperature
 2. Failure of chiller to start or chiller shutdown due to any of the above safety cutouts shall be annunciated by display of the appropriate diagnostic description at the unit control panel.
 3. The chiller shall be furnished with a Master Controller as an integral portion of the chiller control circuitry to provide the following functions:
 - a. Provide automatic chiller shutdown during periods when the load level decreases below the normal operating requirements of the chiller. Upon an increase in load, the chiller shall automatically restart.
 - b. Provisions for connection to automatically enable the chiller from a remote energy management system.
 - c. The control panel shall provide alphanumeric display showing all system parameters in the English language with numeric data in English units.
 4. Normal Chiller Operation
 - a. When chiller is enabled, the factory supplied Master Controller modulates the chiller capacity from minimum to maximum as required by building load.
 - b. The Chiller control system shall respond to Entering Water Temperature and will have an integral reset based on entering water temperature to provide for efficient operation at part-load conditions.

PART 3 - EXECUTION

3.1 INSTALLATION

- A. General: Rig and install in accordance with Manufacturer's requirements and Contract documents.

SECTION 236400 – PACKAGED WATER CHILLERS

- B. Location: Locate chiller as indicated on drawings, including cleaning and service maintenance clearance per Manufacturer instructions. Adjust and level chiller on support structure.
- C. Components: Provide and install all auxiliary devices and accessories for fully operational chiller.
- D. Electrical: Coordinate electrical requirements and connections for power feeds with Divisions 26, 27 and 28.
- E. Finish: Paint damaged and abraded factory finish with touch-up paint matching factory finish.
- F. Controls: Coordinate unit and system control requirements with section 25 9000 – Sequence of Operations.

3.2 UNIT OPERATING MODES (SEQUENCE OF OPERATIONS)

- A. Provide standard operational programming as recommended by unit manufacturer.
- B. For both units, implement standard internal control modes or options as follows (see manufacturer's IOM manual):
 - 1. "Return Chilled Liquid Control" mode as described in the latest edition of the Installation, Operation, And Maintenance (IOM) manual.
 - a. Cooling Setpoint = 42 degrees F.
 - b. Range = 10 degrees F.
 - 2. "Return Chilled Liquid System Lead/Lag and Compressor Sequencing" mode to help equalize average run hours between systems.
 - 3. "Anti-Recycle Timer" to assure the systems do not cycle. Coordinate cycle timer setting (between 300 and 600 seconds) with Manufacturer's recommendation and Owner's requirements.
 - 4. "Anti-Coincident Timer" to assure compressors within a circuit or system do not start simultaneously.

3.3 REPAIR/RESTORATION

- A. Repair any product components broken during installation or startup with replacement parts supplied by the product manufacturer.
- B. Substitute replacement parts from other manufacturers are not acceptable.

3.4 FIELD QUALITY CONTROL

- A. Manufacturer's Field Services:
 - 1. Verify that the units are installed and operational in accordance with the manufacturer's written installation instructions.

SECTION 236400 – PACKAGED WATER CHILLERS

2. Both the Contractor and Manufacturer's Representative(s) shall sign start-up and operational checklist to confirm proper system installation and operation.

3.5 CLEANING

- A. Upon completion of installation and prior to initial start-up, clean internal and external surfaces.

3.6 DEMONSTRATION & START-UP

- A. Provide two Demonstration and Start-up visits to site in Juneau, Alaska:
 1. First on-site visit to coincide with initial start-up of units after completion of installation. Upon completion of this site visit, unit installations and Test and Balance shall be complete, and chilled water system 100 percent functional and ready for Owner's acceptance and use. After demonstration and Owner training, Contractor shall coordinate with Owner for seasonal shutdown of units and system.
 2. Second on-site visit: Coordinate with Owner for seasonal wake-up of units and system. Unit start-up checklist items shall be reviewed and tested for conformity with initial start-up procedures.
- B. Start-up and operate chilled water unit in accordance with the manufacturer's written installation and operation and maintenance.
- C. Verify operating sequence in accordance with above.
- D. Document start-up and operational checks using the manufacturer's installation checklist and submit in accordance with submittal requirements.

3.7 TRAINING

- A. Instruct Owner's Representatives for four hours with regard to:
 1. System start-up.
 2. Normal system operation.
 3. System shut-down.
 4. Packaged control system programming and interfaces.
 5. Preventative maintenance.

END OF SECTION 236400

SECTION 236400 – PACKAGED WATER CHILLERS

THIS PAGE INTENTIONALLY LEFT BLANK

SECTION 238200 – TERMINAL HEATING AND COOLING UNITS

PART 1 - GENERAL

1.1 SUMMARY

- A. Section Includes:
 - 1. Fan coil units.
- B. Related Sections:
 - 1. 200000 - Mechanical General Requirements
 - 2. 200513 - Common Motor Requirements
 - 3. 200529 - Mechanical Hangers and Supports
 - 4. 200553 - Mechanical Identification
 - 5. 200700 - Mechanical Insulation
 - 6. 204100 - Mechanical Demolition
 - 7. 230593 - Testing, Adjusting and Balancing
 - 8. 232113 - Hydronic Piping and Specialties
 - 9. 233100 - Ducts and Accessories
 - 10. 233700 - Air Outlets and Inlets
 - 11. 259000 - Sequence of Operations

1.2 REFERENCES

- A. Codes and Standards: See section 200000 - Mechanical General Requirements.
- B. Abbreviations, Acronyms and Definitions:
 - 1. Refer to Division 01 for general abbreviations, acronyms, and definitions.
 - 2. Refer to Section 200000 - Mechanical General Requirements for general mechanical related definitions.
 - 3. Refer to Mechanical Drawings legend sheet for general mechanical related abbreviations.

1.3 SYSTEM DESCRIPTION

- A. Design Requirements: Provide terminal heating and cooling units, piping, appurtenances, and controls to automatically maintain interior temperature setpoint for each area of the building.
- B. Performance Requirements: Provide performance and output shown or scheduled on drawings.

1.4 PRE-INSTALLATION MEETINGS

- A. See section 200000 - Mechanical General Requirements.

SECTION 238200 – TERMINAL HEATING AND COOLING UNITS

1.5 SUBMITTALS

- A. See section 200000 - Mechanical General Requirements for general submittal requirements for the items listed below, supplemented with the additional requirements listed.
- B. Product Data:
 - 1. Submit product literature for items specified in Part 2 and those products required by the performance standards of this section. Literature clearly annotated to indicate specified salient features and performance criteria.
 - 2. Include the following:
 - a. Performance characteristics as scheduled.
 - b. Enclosure style, material and grille arrangement.
 - c. Dimensional data.
- C. Shop Drawings:
 - 1. Indicate mechanical and electrical service locations and requirements.
- D. Provide certificates, manufacturer's instructions, and manufacturer's field reports for Quality Assurance/Control Submittals:
 - 1. Provide a complete manufacturer's written installation, operation and maintenance manual for each type of installed equipment.
 - 2. Clearly annotate the manual to indicate applicable information for the specific equipment model(s) installed.
 - 3. Included with the manual one copy of the completed start-up and operation checklist. The checklist shall include:
 - a. Printed names and signatures of the installers.
 - b. Documentation from Manufacturer's representative and Contracting Agency that the equipment has been properly installed and is fully operational, thus validating the equipment warranty.
- E. Closeout Submittals:
 - 1. Project Record Documents: Record actual locations of components and locations of access doors in terminal unit cabinets required for access or valves.
 - 2. Operation and Maintenance (IO&M) Manuals:
 - a. Refer to Section 200000 - Mechanical General Requirements, for IO&M Manual formatting requirements and number of copies required.
 - b. Provide copies of approved submittal information for inclusion within the project IO&M Manual. Include manufacturer's descriptive literature, operating instructions, installation instructions, maintenance and repair data, parts listings, and spare parts list.

1.6 CLOSEOUT SUBMITTALS

- A. See section 200000 - Mechanical General Requirements.

SECTION 238200 – TERMINAL HEATING AND COOLING UNITS

1.7 MAINTENANCE MATERIAL SUBMITTALS

- A. See section 200000 - Mechanical General Requirements.
- B. Extra Stock Materials: Provide one set replacement filters for fan coil units.

1.8 QUALITY ASSURANCE

- A. See section 200000 - Mechanical General Requirements.
- B. Regulatory requirements: Products requiring electrical connection shall be listed and classified by Underwriters Laboratories Incorporated, or by a testing firm acceptable to the Authority Having Jurisdiction.

1.9 DELIVERY, STORAGE, AND HANDLING

- A. See section 200000 - Mechanical General Requirements.

1.10 WARRANTY

- A. Manufacturer Warranty: See section 200000 - Mechanical General Requirements, for general mechanical warranty requirements.

PART 2 - PRODUCTS

2.1 FAN COIL UNITS

- A. General:
 - 1. Up-flow, draw through design, all components contained inside the cabinet.
 - 2. 18 gauge galvanized steel cabinet with 14 gauge frame.
 - 3. Unit shall be fully insulated with 1 inch thick, 1.5 pound per cubic foot density insulation. Insulation shall meet the requirements of ASTM C1071, UL181, and ASTM E84 for flame spread and smoke developed.
 - 4. 1-inch duct collar on supply and return connections. Top supply and rear return.
 - 5. Insulated access panels.
- B. UL listed assembly.
- C. Fan Assembly: Direct drive, backward inclined plenum type with EC motor.
- D. Filter: 2-inch pleated MERV 8 filter.
- E. Cooling Units:
 - 1. Capacity as scheduled. Selected and rated in accordance with ARI 410.
 - 2. Provide one piece insulated drain pan, condensate pump and evaporator pan.

SECTION 238200 – TERMINAL HEATING AND COOLING UNITS

- F. Electrical Characteristics: Horsepower, voltage, and phase as scheduled on the drawings, 60 Hz.
- G. Manufacturers: Compu-aire CKC series, or equal.

PART 3 - EXECUTION

3.1 PREPARATION

- A. Protection: Cover equipment and plug piping connections to protect components from construction dirt and debris.
- B. Preparation: Prior to installation of terminal units, make sure wall construction is complete enough to correctly locate and mount units.

3.2 INSTALLATION

- A. Install terminal equipment in accordance with manufacturer's instructions.
- B. Install equipment exposed to finished areas after walls and ceilings are finished and painted.
- C. Provide finished cabinet units with protective covers during balance of construction.
- D. Hydronic Units:
 - 1. Provide accessible ball type isolation valves on supply and return lines to each terminal unit to allow for unit drain down and repair.
 - 2. Provide low-point drain valve that allows for complete gravity draining of terminal unit.
 - 3. Provide balancing valve as specified elsewhere.
 - 4. Provide high-point automatic air vent as specified elsewhere.
- E. Access Doors: Install such that a drain hose may be easily connected to each drain line hose bibb, allowing the applicable portion of the system to be completely drained.
- F. Install balancing valves and serviceable products for heating terminal units to be operable and adjustable without removal of the finish cover.
- G. Provide pressure and temperature test plugs on both sides of heat transfer elements to measure the drop across runs of heat transfer elements.
- H. In systems containing glycol, provide only products specifically designed and approved for continuous operation with the glycol solution specified.

3.3 CONSTRUCTION

- A. Interface with Other Work:

SECTION 238200 – TERMINAL HEATING AND COOLING UNITS

1. Coordinate and sequence installation of terminal heating and cooling units with trades responsible for portions of this and other related sections of the Project Manual.
2. Rework required as a result of failure to follow the manufacturer's written installation instructions or to properly coordinate with related Work shall be completed at no additional expense to the Owner.

3.4 REPAIR/RESTORATION

- A. Repair any product components broken during installation or startup with replacement parts supplied by the product manufacturer.
- B. Substitute replacement parts from other manufacturers are not acceptable.

3.5 FIELD QUALITY CONTROL

- A. Manufacturer's Field Services:
 1. Verify units are installed and operational in accordance with the manufacturer's written installation instructions.
 2. Both the Contractor and Manufacturer's Representatives shall sign start-up and operational checklist to confirm proper unit installation and operation.

3.6 ADJUSTING

- A. Adjust functional components for proper operation in accordance with manufacturer's recommendations, or as otherwise directed.
- B. Coordinate and work directly with the Testing, Adjusting and Balancing Agency to provide systems in proper operating order. Make corrections and adjustments as required by the Balancing and Testing Agency in a timely manner.

3.7 CLEANING

- A. After construction is completed (including painting), and prior to initial start-up, clean and wipe down exposed surfaces of units. Vacuum clean coils and inside of cabinets and enclosures.
- B. Touch up marred or scratched surfaces of factory finished cabinets and enclosures, using finish materials furnished by manufacturer.
- C. Clean permanent filters or install new disposable filters.

3.8 DEMONSTRATION AND START-UP

- A. Start-up and operate terminal heating and cooling units in accordance with the manufacturer's written installation and operation manual check list.

SECTION 238200 – TERMINAL HEATING AND COOLING UNITS

- B. Demonstrate proper system operation using the building automation system.
- C. Document start-up and operational checks using the checklist and submit in accordance with submittal requirements.

END OF SECTION 238200

SECTION 259000 – SEQUENCE OF OPERATIONS

PART 1 - GENERAL

1.1 SUMMARY

- A. Section Includes: This section describes the building automation system (BAS) control sequences for the heating, ventilating and air-conditioning (HVAC) systems, electrical systems and plumbing systems provided for this project.

1.2 SYSTEM DESCRIPTION

- A. Building Automation System controls shall be an extension of the existing facility controls. Current facility building automation system controls are provided by Long.

1.3 SUBMITTALS

- A. Submit in accordance with Section 200000 - Mechanical General Requirements and in accordance with Division 1.

- B. Product Data:

- 1. Provide BAS manufacturers' product literature, clearly annotated to indicate performance criteria to include the following:
 - a. Building level to floor level network controller riser diagrams. Include building locations and equipment controlled by each controller.
 - b. Sequences of operation for HVAC, electrical and plumbing systems.
 - c. Process control diagrams to support each sequence of operation. Show field mounted control device locations and circuit routing.
 - d. Field devices.
 - e. Complete electrical BAS points list.

- C. Quality Assurance/Control Submittals:

- 1. Installation and Functional Performance Test Letter.
 - a. Provide a letter certifying that the building automation system hardware is completely installed and sequences of operation have been programmed, operationally tested, with physical verification, to comply with the sequences of operation as specified. The installer(s), sub-contractor(s) and the Contractor must sign the letter.
 - b. Include as an attachment, a list of programming deviations from the specified sequences of operation with justification to support each deviation.
 - c. Include as an attachment, a table of final adjustable setpoint values for each applicable control point.

- D. Installation, Operation and Maintenance Data:

- 1. Refer to Section 200000 – Mechanical General Requirements, for IO&M Manual formatting requirements and number of copies required.

SECTION 259000 – SEQUENCE OF OPERATIONS

2. Provide approved submittal information, revised to reflect the actual installation as addressed in the attachments provided with the Installation and Functional Performance Test Letter, for inclusion within the project IO&M Manual.

1.4 CLOSEOUT SUBMITTALS

- A. Submit in accordance with 200000 - Mechanical General Requirements and in accordance with Division 1.

1.5 MAINTENANCE MATERIAL SUBMITTALS

- A. See section 200000 - Mechanical General Requirements.

1.6 QUALITY ASSURANCE

- A. Qualifications of Installers/Programmers: Minimum 3 years' experience in the installation and programming of direct digital control systems.

PART 2 - PRODUCTS - NOT USED

PART 3 - EXECUTION

3.1 ROOM VENTILATION, HEATING, AND COOLING

- A. Typical Zone VAV Temperature/Humidity Control with Reheat.
 1. Zone Sensors.
 - a. Zone Thermostat: Provide wall-mounted zone thermostat with input to zone VAV terminal equipment controller.
 - b. Zone Humidistat: Provide wall-mounted zone humidistat with input to applicable humidification system packaged controller.
 - c. Zone thermostat and humidistat may be combined into common unit.
 2. Day Mode Operation.
 - a. Cooling Mode: Modulate the VAV terminal unit control damper between Minimum CFM and Maximum Cooling CFM to maintain zone day setpoint temperature plus or minus one (1)-degree F. Reheat coil control valves remain shut.
 - b. Heating Mode: Modulate the VAV terminal unit control damper between Minimum CFM and Maximum Heating CFM to maintain zone day setpoint temperature plus or minus one (1)-degree F. Modulate VAV reheat coil control valve in parallel with control damper.
 - c. Humidification Control: Control relative humidity setpoint utilizing packaged humidification system controller.
 3. Night Mode Operation.
 - a. Heating Mode: When air handler is operating, modulate VAV terminal unit control damper between Minimum CFM and Maximum Heating CFM to maintain zone

SECTION 259000 – SEQUENCE OF OPERATIONS

night setpoint temperature plus zero (0), minus three (3) degrees F. Modulate VAV reheat coil control valve in parallel with control damper.

- b. Cooling Mode: When air handler is operating, modulate VAV terminal unit control damper between Minimum CFM and Maximum Cooling CFM to maintain zone night setpoint temperature plus three (3), minus zero (0) degrees F. Modulate VAV reheat coil control valve in parallel with control damper.
- c. Humidification Control: Control relative humidity setpoint utilizing packaged humidification system controller.

B. Maintenance and Alarm Monitoring.

- a. Zone Temperature Monitoring:
 - 1). Generate "AHU-X Zone Temperature High/Low" maintenance alarm if any zone temperature is not being maintained within setpoint band tolerance.
 - 2). Generate "AHU-X Zone Low Temperature" critical alarm if any zone temperature falls below 55 degrees F. (adjustable).
- b. Zone Humidity Monitoring:
 - 1). Generate "AHU-X Zone Humidity Low" maintenance alarm if any zone relative humidity drops below 20 percent.
 - 2). Generate "AHU-X Zone Humidity High" maintenance alarm if any zone relative humidity increases above 60 percent.

3.2 CENTRAL CHILLER (CH-3) OPERATING AND MONITORING

- A. The central chiller utilizes packaged controls determine free-cooling, rotation of mechanical chiller modules, rotation of primary/standby pumps, and modulation of chiller modules to maintain the chilled glycol supply temperature at the supply temperature setpoint of 44 degrees F (adjustable).
- B. Provide BAS monitoring of the central chiller via BACnet connection. Coordinate with Owner on chiller points to be monitored.

3.3 MRI COOLING

A. Primary Cooling:

- 1. The MRI machine receives primary cooling through the central chiller (CH-3). The three-way valve shall be installed to fail in a position to allow chilled glycol to be continuously circulated from the central chiller through the Siemens SEP. The three-way valve will be commanded closed by the operator via the BAS in order to allow secondary cooling to occur.

B. Secondary Cooling:

- 1. Operator to override three-way valve via the BAS to allow full bypass of the Siemens SEP by the central chiller (CH-3). Isolation valves on the supply and return lines from CH-3 to be manually closed. Isolation valves on the supply and return lines from existing building central chiller (WCU-3) to be manually opened to allow flow from WCU-3.

C. Tertiary Cooling:

SECTION 259000 – SEQUENCE OF OPERATIONS

1. Three-way valve to remain overridden via the BAS for full bypass of the Siemens SEP. Isolation valves on the supply and return lines from CH-3 to be manually closed. Isolation valves on the supply and return lines from WCU-3 to be manually closed. Isolation valves on the cold water pipe and drain pipe to be manually opened to allow flow from the building's domestic cold water system and discharged to a nearby floor sink. Domestic cold water through the Siemens SEP is protected from the rest of the facility by an existing reduced pressure backflow preventer.

3.4 SOUTH CT HEAT EXCHANGER COOLING

- A. The CT Machine receives cooling through the central chiller (CH-3). The three-way valve shall be installed to fail in a position to allow chilled glycol to be continuously circulated through CT interface heat exchanger. The three-way valve will be commanded closed by the operator via the BAS in order to perform maintenance on the CT equipment.

3.5 NORTH CT FAN-COIL UNIT (AC-X)

- A. North CT room primary cooling to be provided by central ventilation system.
- B. Provide discharge air temperature sensor in supply ductwork downstream of AC-X.
- C. If the room temperature increases two (2) degrees F above the room setpoint temperature, enable AC-X fan at 50 percent speed. Modulate chilled water coil three-way control valve to maintain a 55 degrees F supply air temperature.
- D. If room temperature continues to increase, increase AC-X fan speed and continue to modulate three-way valve to maintain 55 degrees F supply air temperature.
- E. If room temperature decreases to room temperature setpoint, reverse AC-X sequence above.

END OF SECTION 259000

SECTION 260000 – ELECTRICAL GENERAL REQUIREMENTS

PART 1 - GENERAL

1.1 SUMMARY

- A. Drawings and general provisions of the Contract, including General and Supplementary Conditions and Division 1 Specifications Sections, apply to this Section.
- B. This section describes specific requirements, products, and methods of execution, which are typical throughout the electrical work of this project. Additional requirements for the specific systems may modify these requirements.
- C. This Section applies to all Divisions 26 and 27 and is part of all other Divisions 26 and 27 Sections.
- D. Index of Electrical Specifications:
 - 1. 260000 - Electrical General Requirements
 - 2. 260519 - Low Voltage Electrical Power Conductors and Cables
 - 3. 260526 - Grounding and Bonding for Electrical Systems
 - 4. 260529 - Hangers and Supports for Electrical Systems
 - 5. 260533 - Raceway and Boxes for Electrical Systems
 - 6. 260553 - Identification for Electrical Systems
 - 7. 262416 - Panelboards
 - 8. 262726 - Wiring Devices
 - 9. 262800 - Low Voltage Circuit Protective Devices
 - 10. 262900 - Low Voltage Controllers
 - 11. 265000 - Lighting Fixtures
 - 12. 270536 - Cable Trays

1.2 REFERENCES

- A. Codes: Perform work in strict accordance with applicable national, state and local codes; including, but not limited to the latest legally enacted editions of the following specifically noted requirements:
 - 1. NFPA 70, National Electrical Code - NEC.
 - 2. ANSI-C2, National Electrical Safety Code - NESC.
 - 3. International Building Code - IBC.
 - 4. International Fire Code - IFC.
 - 5. Underwriters Laboratory (UL) or approved equal.
- B. Standards: Reference to the following standards infers that installation, equipment and material shall be within the limits for which it was designed, tested and approved, in conformance with the current publications and standards of the following organizations:
 - 1. American National Standards Institute - ANSI.
 - 2. American Society for Testing and Materials - ASTM.

SECTION 260000 – ELECTRICAL GENERAL REQUIREMENTS

3. American Society of Heating Refrigerating and Air Conditioning Engineers - ASHRAE.
4. Institute of Electrical and Electronics Engineers - IEEE.
5. Insulated Cable Engineers Association - ICEA.
6. National Electrical Manufacturers' Association - NEMA.
7. National Fire Protection Association - NFPA.

1.3 DEFINITIONS

- A. "Accessible" means arranged so that an appropriately dressed man, 6 feet-2 inches tall, weighing 250 pounds, may approach the area in question with the tools and products necessary for the work intended and may then position himself to properly and safely perform the task to be accomplished, without disassembly or damage to the surrounding installation.
- B. "Authority Having Jurisdiction" is the individual official, board, department, or agency established and authorized by the political subdivision created by law to administer and enforce the provisions of the Code as adopted or amended.
- C. "As Specified" denotes a product, system, or installation that:
 1. Includes all of the salient characteristics identified in the Drawings and Specifications;
 2. Meets all of the requirements of the "Basis of Design"; and
 3. Is produced by a manufacturer listed as acceptable on the Drawings or in the Specifications.
- D. "Basis of Design" refers to products around which the design was prepared. Some or all of the particular characteristics of Basis of Design products may be critical to the fit or performance of the completed installation. Such characteristics are often subtle. Where substitutions are made to products that are the Basis of Design, the Contractor is alerted that nominally acceptable substitutions may produce undesirable side effects such as switchboards that no longer fit the space due to increased product dimensions. The Contractor is responsible for resolving all impacts of substitutions. Approval of a substitution request does not relieve the Contractor of complying with the design intent and all Codes.
- E. "Contracting Agency" is the Owner as defined in the General Conditions of the Contract.
- F. "Demolish" means to permanently remove a component, equipment, or system and its appurtenances with no intent for reuse and to properly dispose of it.
- G. "Furnish" means to purchase material as shown and specified, and cart the material to an approved location at the site or elsewhere as noted or agreed to be installed by supporting crafts.
- H. "Install" means to set in place and connect, ready for use and in complete and properly operating finished condition, material that has been furnished.
- I. "Product" is a generic term that includes materials, equipment, fixtures and any physical item used on the project.
- J. "Provide" means furnish all products, labor, subcontracts, and appurtenances required and install to a complete and properly operating, finished condition.

SECTION 260000 – ELECTRICAL GENERAL REQUIREMENTS

- K. "Remove" means to remove a component, equipment, or system and its appurtenances and either store it for re-installation, reuse, or turn it over to the Contracting Agency.
- L. "Rough-in and Connect" means provide an appropriate system connection such as conduit with junction boxes, wiring, switches, disconnects, etc., and wiring connections. Equipment furnished is received, uncrated, assembled, and set in place under the Division in which it is specified.
- M. "Serviceable" means arranged so that the component or product in question may be properly removed, and replaced without disassembly, destruction or damage to the surrounding installation. "Serviceable" components shall be "accessible".
- N. "Shop Drawings" are dimensioned working construction drawings drawn to scale to show an entire area of work in sufficient detail to demonstrate service and maintenance clearances and complete coordination of all trades.
- O. "Substitution" is a product, system or installation that is not by a listed manufacturer or does not conform to all salient characteristics identified in the Contract Documents, but which the Contractor warrants meets all specific requirements listed in the Contract Documents.
- P. "System Drawing" is a diagrammatic engineered drawing that shows the interconnection and relationship between products to demonstrate how the products interact to accomplish the function intended. Examples of system drawings include control and instrumentation diagrams, and wiring diagrams. Some drawings, such as dimensioned and complete Fire Suppression Drawings may be both System Drawings and Shop Drawings.

1.4 PERFORMANCE REQUIREMENTS

- A. Provide labor, products and services required for the complete installation, checkout and startup of electrical systems shown and specified. Where the work of several crafts is involved, coordinate related work to provide each system in complete and in proper operating order.
- B. Lay out the work in advance and avoid conflict with other work in progress. Physical dimensions shall be determined from existing conditions. Verify locations for junction boxes; disconnect switches, stub-ups, etc., for connection to equipment furnished by others, or in other Divisions of this Work.
- C. Refer to the "Suggested Coordination Schedule" in Section 20 0000 - Mechanical General Requirements.
- D. Cooperate with others involved in the project, with due regard to their work, to promote rapid completion of the entire project.
- E. Coordinate installation of panels, equipment, system components, and other products to provide proper service areas and access for items requiring periodic maintenance inspection or replacement.
- F. Reference to a specific manufacturer's product (even as "Basis of Design") does not necessarily establish acceptability of that product without regard to compliance with all other provisions of these specifications.

SECTION 260000 – ELECTRICAL GENERAL REQUIREMENTS

- G. Local Conditions: The Contractor shall thoroughly familiarize himself with the work as well as the local conditions under which the work is to be performed. Schedule work with regard to seasons, weather, climatic conditions and other local conditions which may affect the progress and quality of the work.
- H. Utility Coordination: Coordinate work with the serving utilities (electrical, telephone, cable television, etc.) and provide equipment and installation in accordance with the respective utility requirements. Meet with the serving utilities and coordinate the installation and location of the services. Provide a written statement of approval from each serving utility. Provide trenching from telephone and television stubout locations to property line in accordance with respective utility requirements.
- I. Demolition: Coordinate related demolition in support of the project. Restore circuits and systems, which are to remain, but which are affected in any way by demolition Work. Conduct a site visit prior to bid to determine Scope. Refer to Part 3 of this Section for execution requirements.

1.5 SUBMITTALS

- A. Refer to Division 1 for general submittal, closeout submittal and product substitution requirements. In addition, prepare Divisions 26 and 27 submittals in accordance with the following.
- B. Specification section drawings, calculations, and products shall be complete and submitted together in one package.
- C. General:
 - 1. The Contracting Agency's obligation to review submittals and to return them in a timely manner is conditioned upon the prior review and approval of the submittals by the Contractor as required by the Construction Contract.
 - 2. Streamlining: in many instances, the products, reference standards, and other itemized specifications have been listed without verbiage. In these cases, it is implied that the Contractor shall provide the products and perform in accordance with the references listed.
 - 3. Submittal review is for general design and arrangement only and does not relieve the Contractor from any of the requirements of the Contract Documents.
 - 4. Submittals will not be checked for quantity.
 - 5. Submittals will not be exhaustively checked for dimension or fit, or for proper technical design of manufactured equipment. Provision of a complete and satisfactory working installation is the responsibility of the Contractor.
 - 6. Furnish suppliers with the applicable portions of the Contract Documents and review and verify that the suppliers' submittals clearly represent products which comply with the Contract Documents.
- D. Electronic Submittals:
 - 1. Submittals may be in electronic (PDF) format.

SECTION 260000 – ELECTRICAL GENERAL REQUIREMENTS

- a. Electronic submittals shall follow the organization and formatting required for paper submittals.
 - 1). Provide electronic bookmarks within the PDF document in place of tabs and sub-tabs.
 - 2). If individual PDF files are provided for each product or shop drawing sheet, organize files into folders and name files and folders to correspond with applicable specification sections or drawing titles.
- b. If submittal is a scanned document, run the optical character recognition OCR function to ensure the document is searchable and can be copied and pasted.
- c. Electronic submittals may be transmitted via Email, disc or download from a project or construction Website.

E. Coordination:

1. Create and maintain a master submittal log for all items submitted in Divisions 26 and 27.
2. Prior to submission for approval hold a meeting of all trades to review all shop drawings and submittals. All trades shall cross-check all shop drawings and submittals for conflicts, clearances, physical space allocation and routing, discrepancies, dimensional errors, omissions, contradictions, departures from the Contract requirements, correct electrical/mechanical services and connections, and provisions for commissioning.
3. Revise, correct, and appropriately annotate submittals prior to submission for approval.
4. A current copy of approved submittals and the submittal log shall be kept at the job site.

F. Product Submittals

1. General: This section describes in detail the preparation of electrical product submittals. Submittals not provided as described shall be rejected without review. This procedure is designed to accelerate and improve the accuracy of the technical review process, as well as, simplify the preparation of the Installation, Operation, and Maintenance Manuals (IO&Ms) during project closeout.
2. Submittal Organization:
 - a. Organize product submittal information in the same order as the products are specified to simplify the technical review process. Provide a separate tabbed divider for each Divisions 26 and 27 specification section. Provide the typed section number on each tab.
 - b. Within each section, organize the product information in the same order as the products are specified in Part 2 of each applicable specification section. Provide sub-tabs within each section for each separate product article. Provide the typed product article number on each tab.
 - c. Provide product submittal information for each product specified in 8-1/2" x 11" format. Fold-out 11" x 17" format is also acceptable.
 - d. If a particular specified product is being omitted from the product submittal or will not be used for the project, provide a single sheet within the article tab identifying the product and annotated with a brief reason why the product is not being submitted, for example: "NOT USED," "NO SUBMITTAL REQUIRED," "TO BE SUBMITTED BY (PROVIDE DATE)," etc. This will inform the reviewer that the product was not overlooked.
 - e. Partial submittals from individual subcontractors may be provided which cover a particular sub-contractor's scope of work. In this case, arrange partial submittals by

SECTION 260000 – ELECTRICAL GENERAL REQUIREMENTS

system classification such as: LIGHTING, POWER DISTRIBUTION, FIRE ALARM, ACCESS CONTROL SYSTEM, etc. Within each system classification, arrange product submittals by specification section, as described, such that each specification section can easily be reorganized into a master set of Divisions 26 and 27 product submittals organized by specification section. This will greatly simplify the preparation of IO&M manuals as described below.

- f. Bind product submittal information in 3 inch wide, hard backed, loose leaf, 3 ring binders with clear front and spine insert pockets. Divide information into multiple volumes such that the pages in each binder rest naturally on one side of rings.
 - g. Provide a master table of contents at the front of each volume which lists the Divisions 26 and 27 specification sections and indicates which sections are located within each volume.
 - h. Provide a table of contents within each section which lists the Part 2 products for that section in the same order as the applicable specification section.
 - i. Provide identical cover and spine inserts for each product submittal volume.
 - j. For multiple volumes, label each volume. Include the following typed information on the front cover and spine inserts of each volume:
 - 1). The Contracting Agency Name
 - 2). Project Name
 - 3). Contractor Name
 - 4). Subcontractor Name preparing the submittal.
 - 5). Date that the submittal or resubmittal was initiated.
 - 6). “Electrical Product Submittals”, etc. as appropriate.
 - 7). “Volume 1 of X, Volume 2 of X,” etc.
3. Product Information:
- a. Indicate manufacturer's name and address, and local supplier's name, address, phone number.
 - b. Indicate each product as “Basis of Design”, “As Specified” or as “Proposed Substitution.”
 - c. Identify Catalog designation and/or model number.
 - d. Neatly annotate each salient characteristic and design options of the product to demonstrate compliance with the Contract Documents to include: Scheduled information, drawing information and specified information. Clearly indicate product deviations from the Contract Documents and mark out non-applicable items on generic “cut-sheets.”
 - e. Include manufacturer provided dimensioned equipment drawings with mechanical and electrical rough-in connections.
 - f. Include operation characteristics, performance curves and rated capacities.
 - g. Include motor characteristics and wiring diagrams for the specific system.
 - h. Provide basic manufacturer’s installation instructions.
4. Provide coordination data to check protective devices.
5. Provide information required to verify compliance with the short circuit withstand and interrupting ratings, as shown on the Drawings or further stated in these Specifications.
6. Provide certification that all data shown on the Drawings or further stated in these Specifications concerning available short-circuit currents has been confirmed with the serving Electric Utility.
7. Product Substitutions:

SECTION 260000 – ELECTRICAL GENERAL REQUIREMENTS

- a. Clearly indicate both in the section table of contents and on the individual product submittal information each proposed substitution, deviation or change from the product as described in the Contract Documents.
- b. Submittal approval does not include substitutions, deviations or changes from the requirements of the Contract Documents unless they are specifically itemized and approved. The term “No Exceptions Taken” will not apply to substitutions, deviations or changes not clearly identified.
- c. Provision of a satisfactory working installation of equal quality to the system as described in the Contract Documents shall be the responsibility of the Contractor.
- d. Correct unapproved deviations from the Contract Documents discovered in the field as directed by the Contracting Agency at no additional cost to the Owner.

G. System Drawings:

1. Submit System Drawings for dynamic elements/systems of the project which are performance specified to include but not limited to: Fire Alarm Systems, Lightning Protection Systems and stand-alone packaged equipment.
2. Prepare system drawings on full sized sheets of the same size as the original construction drawings.
3. Include with each system a sequence of operation narrative which describes each mode of system operation in sufficient detail to demonstrate compliance with the Contract Documents to the satisfaction of the Contracting Agency.

H. Shop Drawings:

1. General:
 - a. The Contract Documents are not intended for nor are they suitable for use as shop drawings. Do not use Contract Drawings for direct fabrication or installation of products or equipment.
 - b. Divisions 26 and 27 products and systems shall not be installed without shop drawings approved by the Contracting Agency.
 - c. Rework, changes or additional engineering support required as a result of the installation of products and systems prior to the approval of applicable shop drawings by the Contracting Agency shall be provided at the Contractor’s expense.
2. Preparation:
 - a. Review each Divisions 26 and 27 specification section and identify the project’s shop drawing requirements.
 - b. Prepare shop drawings on full sized sheets of the same size as the original construction drawings.
 - c. Arrange shop drawings to scale, showing dimensions where accuracy of location is necessary for coordination or communication purposes.
 - d. Incorporate the actual dimensions and configurations of the products and systems approved through the product submittal process into the shop drawings.
 - e. Provide dimensioned maintenance clearance areas around each product as recommended by the manufacturer.
 - f. Meet with and coordinate Divisions 26 and 27 work with the interrelated work of other trades including Architectural, Civil, Structural, and Mechanical to identify and resolve potential conflicts.

SECTION 260000 – ELECTRICAL GENERAL REQUIREMENTS

- g. Clearly identify and provide recommendations to resolve major conflicts which may impact the design of the systems as shown. Resolve such conflicts during the shop drawing review process.
 - h. In cases where one or more equipment items in a mechanical or electrical room or space differ in dimensions or configuration from Basis of Design equipment, the working drawing shall show the entire area. The drawing shall be dimensioned to indicate that required aisle ways and maintenance clearances are being maintained to at least the degree shown on the Contract Drawings.
 - i. Provide shop drawings for all products, systems, system components, and special supports that are not a standard catalog product and which may be fabricated for the Contractor or by the Contractor. In addition provide shop drawings for:
 - 1). Electrical and telecommunications rooms and spaces, including all equipment. Demonstrate all required clearances and working spaces are provided.
 - 2). Routing and interdisciplinary coordination of groups of conduits numbering more than one and over two inch trade size.
 - 3). Busways.
 - 4). Cable Trays.
 - 5). Floor ducts.
 - 6). Telecom equipment rack elevations.
 - 7). CCTV equipment rack elevations.
 - 8). Where noted on the drawings.
 - 9). Where noted in other Divisions 26 and 27 sections.
 - j. Record Shop Drawings: Provide a copy of the final, corrected, approved shop drawings for the project, updated to show as-built conditions. Drawings shall indicate exact device locations and conduit and wire routing. Prepare drawings using the latest release of AutoCAD and deliver files to the Contracting Agency. Refer to other specification sections for additional system specific requirements.
3. Shop Drawing Submittal:
- a. Submit dimensioned shop drawings as specified to demonstrate proper planning and sequencing of the applicable trades for the installation and arrangement of Divisions 26 and 27 with respect to other interrelated work.
 - b. Installation conflicts arising from the failure to properly coordinate the work of related trades shall be resolved at the Contractor's expense.
- I. Record Drawings
- 1. General: As the Work progresses, neatly annotate a designated and otherwise unused, set of Divisions 26 and 27 Contract Drawings to show the actual locations and routing of Divisions 26 and 27 Work and the terminal connection points to related Work. As a minimum, include the following:
 - a. Annotate record drawings to incorporate each applicable addendum.
 - b. Annotate record drawings as directed by each applicable Request for Information (RFI) and accepted Change Order Proposal.
 - c. Modify record drawings to show actual equipment sizes and locations.
 - d. Provide fully dimensioned locations for permanently concealed conduits (i.e. conduit cast in concrete or buried underground/underslab).
 - e. Show routing of work in permanently concealed blind spaces within the building.

SECTION 260000 – ELECTRICAL GENERAL REQUIREMENTS

- f. Maintain drawings in an up-to-date fashion in conjunction with the actual progress of installation. Accurate progress mark-ups shall be available on-site for examination by the Contracting Agency or his representative at all times.
2. Preparation:
 - a. Neatly annotate record drawings to provide clear interpretation to support electronic drafting by a third party.
 - b. Tape electronic sketches from addendums and/or RFIs directly to the record drawings as overlays.
 - c. Annotate the record drawings in colored pencil using the same symbols and abbreviations as indicated in the Divisions 26 and 27 legends and schedules of the Contract Drawings.
 - 1). Red to add information.
 - 2). Green to delete information.
 - 3). Blue to provide additional clarifying information which is not to be drafted.
 - d. After submittal to the Contracting Agency, provide additional clarification, information or rework as necessary to support the accurate interpretation and electronic drafting of the record drawings.
 3. Submittals:
 - a. Provide dimensioned underslab record drawings to the Contracting Agency prior to pouring the slab. For slabs poured in multiple sections, provide record drawings for the applicable slab sections to the Contracting Agency prior to each pour.
 - b. Provide complete record drawings for concealed areas (i.e. above lay-in and hard ceilings and inside walls) to the Contracting Agency prior to concealment.
 - c. Provide the remaining portion of the record drawings for exposed areas to the Contracting Agency prior to the final completion of the project.
 - d. Prepare wiring diagrams for individual special systems as installed. Identify components and show wire and terminal numbers and connections. Include diagrams from the shop drawings and submittals, updated to show as-built condition.
- J. Test Certificates:
1. Review the submittal requirements for Quality Assurance/Control Submittals for each specification section.
 2. Submit copies of design data, test reports, certificates, manufacturer's instructions and field test reports as specified. This information may be included within the Operations and Maintenance (IO&M) Manuals as determined by the Contracting Agency.
- K. Operations and Maintenance (IO&M) Manuals:
1. Provide specific product IO&M information for each section as detailed within each Divisions 26 and 27 section.
 2. Begin the preparation of the electrical Operation and Maintenance Manuals with a complete and fully approved set of electrical product submittals organized, annotated and with the product information as indicated within the "Product Submittals" article for each specification section.
 3. Next, augment each individual product submittal with the written installation, operations and maintenance information for each specific product. Obviously, this type of information is

SECTION 260000 – ELECTRICAL GENERAL REQUIREMENTS

not applicable (or available) for bulk commodity or simplistic products such as conduit or equipment tags, etc.

4. Maintenance information shall include:
 - a. Preventive maintenance requirements for each product, including the recommended frequency of performance of each preventive maintenance task.
 - b. Instructions for troubleshooting, minor repair and adjustments required for preventive maintenance routines, limited to repairs and adjustments that may be performed without special tools or test equipment and that require no extensive special training or skills.
 - c. Information of a maintenance nature covering warranty items, etc., that have not been discussed in the manufacturers' literature.
 - d. Information data for spare and replacement parts for each product and system. Properly identify each part by part number and manufacturer.
 - e. Recommended spare parts list.
5. Organize the Operation and Maintenance Manual information by specification section (not by sub-contractor) with a tabbed divider separating each section. Provide the typed section number on each tab.
6. Within each section, organize the product information in the same order as the products are specified in Part 2 of each applicable section. Provide sub-tabs within each section for each product. Provide the typed product article number on each tab.
7. Bind the information in identical, 3 inch wide; hard backed loose leaf 3 ring binders with clear front and spine insert pockets. Divide information into multiple volumes so that the pages in each binder rest naturally on one side of rings.
8. Provide a master table of contents at the front of each volume which lists the Divisions 26 and 27 specification sections and indicates which sections are located within each volume.
9. Provide a table of contents within each section which lists the Part 2 products for that section in the same order as the applicable specification section.
10. Provide identical cover and spine inserts for each IO&M manual volume.
11. For multiple volumes, label each volume.
12. Include the following typed information on the front cover and spine inserts of each volume:
 - a. The Contracting Agency Name.
 - b. Project Name.
 - c. "Electrical Operations and Maintenance Manual".
 - d. "Volume 1 of X, Volume 2 of X," etc.
13. Submit copies of all Operation and Maintenance Manuals in electronic format (Adobe PDF).

1.6 QUALITY ASSURANCE

- A. Qualifications: Perform the Work using qualified workmen that are experienced and usually employed in the trade.
- B. Product Testing and Certification:
 1. Nationally Recognized Testing Laboratory (NRTL) Labeling: Electrical equipment and conductors shall be "Approved," "Certified," "Identified," or "Listed" and "Labeled" to establish that the electrical equipment is safe, free of electrical shock and fire hazard, and

SECTION 260000 – ELECTRICAL GENERAL REQUIREMENTS

suitable for the purpose for which it is intended to be used. The manufacturer shall have the specific authorization of one of the Occupational Safety and Health Administration (OSHA) approved Nationally Recognized Testing Laboratories (NRTLs) in accordance with the applicable national standards to label the equipment as suitable.

2. Further details on the specific NRTLs, as well as the product standards that they are specifically recognized to evaluate equipment in accordance with, can be found on the OSHA Web site: <http://www.osha.gov/dts/otpc/nrtl/>

C. Drawings and Specifications:

1. The Drawings and specifications are complementary. Do not scale the Drawings. Locations of devices, fixtures, and equipment are approximate unless dimensioned.
2. The Drawings are partly diagrammatic and do not show precise routing of conduits or exact location of all products, and may not show in minute detail all features of the installation; however, provide all systems complete and in proper operating order.
3. Drawing symbols used for basic materials, equipment and methods are commonly used by the industry. Special items are identified by a supplementary list of graphical illustrations, or called for on the Drawings or in the specifications.

D. Tests and Inspections:

1. Schedule, obtain, and pay for permits and fees required by local authorities and by these specifications.
2. Request for Tests: Notify the Contracting Agency a minimum of 24 hours in advance of tests. In the event the Contracting Agency does not witness the test, certify in writing that all specified tests have been made in accordance with the specifications.
3. Deficiencies: Immediately correct deficiencies that are evidenced during the tests and repeat tests until system is approved. Do not cover or conceal electrical installations until satisfactory tests are made and approved.
4. Operating Tests: Upon request from the Contracting Agency, place the entire electrical installation and/or any portion thereof, in operation to demonstrate satisfactory operation.
5. The Contracting Agency may inspect and approve sample installation of systems and equipment prior to general installation of units.
6. Test Witness: Arrange for the Contracting Agency to witness tests. The Contracting Agency may waive witnessing any specific test at its discretion.
7. Tests: During final inspection, conduct operating tests for approval. Demonstrate installation to operate satisfactorily in accordance with requirements of Contract Documents. Should any portion of installation fail to meet requirements of Contract Documents, repair or replace items failing to meet requirements until items can be demonstrated to comply. Have instruments available for measuring light intensities, voltage, and current values and for the demonstration of continuity, grounds, or open circuit conditions. Furnish personnel to assist in taking measurements and making tests. In the event that systems are not complete and fully operational at the time of final inspection, all costs of any subsequent inspections shall be borne by the Contractor at no additional cost to the Owner.

Certificate of Completion: Submit at time of request for final inspection, a complete letter in _____ the _____ following _____ format:
I, _____ (Name), of _____ (Firm), certify that the electrical work is complete in accordance with Contract Plans and Specifications, and authorized change orders (copies of which are attached hereto) and will be ready for

SECTION 260000 – ELECTRICAL GENERAL REQUIREMENTS

final inspection as of _____(Date). I further certify that the following Specifications requirements have been fulfilled:

- a. Megger readings performed, ____ copies of logs attached.
- b. Operating manuals completed and instruction of operating personnel performed, _____ (Date) _____(Signed)

 Owner's Representative
- c. Record document drawings up-to-date, accurate, and ready to deliver to Contracting Agency.
- d. Emergency systems tested and fully operational.
- e. Fire Alarm System tested and fully operational.
- f. Security System tested and fully operational.
- g. Telecommunications System test reports have been submitted to and approved by the Contracting Agency. The test reports shall certify that the Telecommunications System is complete, passes all test criteria, is fully operational, and that all work has been witnessed as specified.
- h. Generation System and controls tested and fully operational.
- i. Intercom/Clock System tested and fully operational.
- j. Ground-fault system performance test complete, copies of logs attached.
- k. Other tests required by Specifications have been performed.
- l. Specified Owner training complete.
- m. Systems are fully operational. Project is ready for final inspection.

SIGNED: _____ DATE: _____
TITLE: _____

- 8. Operating Instructions: Prior to final acceptance, instruct an authorized representative of the Owner on the proper operation and maintenance of electrical systems and equipment provided under this contract. This requirement is for several systems, and is in addition to special training specified in other sections. Make available a qualified technician for each component of the installation for this instruction. Give these operating instructions after the operation and maintenance manuals have been furnished to the Owner. Submit written certification, signed by the Contractor and an authorized representative of the Owner, that this has been completed.

1.7 WARRANTY

- A. Warranty work shall be promptly coordinated and performed at the Contractor's sole expense. Workmanship, labor and materials (without limitation) in this Division shall be warranted for the longer of the following:
 - 1. As called for in the General Conditions of the Contract.
 - 2. For a minimum period of one year from the date of final acceptance.
 - 3. For the extended warranty period specified in a specific Section under this Division.
- B. Where a specific product carries a longer warranty as a standard offering of its manufacturer, extended warranty coverage beyond these requirements shall be retained by the Owner. The Owner will have recourse back to the manufacturer only in these cases, when the warranty as specified in A above has expired.

SECTION 260000 – ELECTRICAL GENERAL REQUIREMENTS

PART 2 - PRODUCTS

2.1 MATERIALS AND EQUIPMENT FURNISHED IN DIVISIONS 26, 27 AND 28

- A. Materials furnished and installed in permanent construction shall be new, full-weight, standard in every way, and in first class condition.
- B. Materials shall conform to the standards of an organization acceptable to the Authority Having Jurisdiction and concerned with product evaluation that maintains periodic inspection of labeled equipment or materials and by whose labeling the manufacturer indicates compliance with appropriate standards or performance in a specified manner. Only materials designed for the purpose employed shall be used.
- C. Materials shall be identical with apparatus or equipment that has been in successful operation for at least two years. Materials of similar class or service shall be of one manufacturer.
- D. Capacities, sizes, and dimensions given are minimums unless otherwise indicated. Systems, materials and equipment proposed for use on this project shall be subject to review for adequacy and compliance with Contract Documents.

2.2 MATERIALS AND EQUIPMENT FURNISHED IN OTHER DIVISIONS

- A. Controls, including conduit, wiring, and control devices required for the operation of systems furnished in other Divisions shall be provided complete under the Division of the Specifications in which the equipment is specified, unless otherwise noted or specified.
- B. Work on the project that falls under the jurisdiction of the electrical trade shall be performed by Licensed Electricians in conformance with the electrical specifications.
- C. Provide complete power connections to equipment including but not limited to feeders, connections, disconnects and motor running overcurrent protection. Where starters are provided as part of packaged equipment, overcurrent heaters shall be provided under Divisions 26, 27 and 28.

PART 3 - EXECUTION

3.1 COORDINATION WITH ROOM NUMBERING

- A. Certain systems provided under this Division rely on identification systems that are based on room names or numbers. Systems labeled in this fashion include, but are not limited to, panelboards, circuit directories, communication and data systems identifiers, fire alarm systems, etc.
- B. The numbering scheme indicated in these Contract Documents is based on room numbers assigned during the design process. The Owner reserves the right to change the numbers prior to substantial completion, and the final names and numbers will not necessarily match those found in the Documents. Obtain from the Owner the final room numbers prior to commencing the

SECTION 260000 – ELECTRICAL GENERAL REQUIREMENTS

numbering of Divisions 26 and 27 systems. Tag and label all system circuits and devices in accordance with the final numbering scheme at no additional cost.

3.2 INSTALLATION

- A. Skilled craftsmen shall install materials and equipment. The norms for execution of the work shall be in conformity with NEC Chapter 3 and the National Electrical Contractors' Association "National Electrical Installation Standards", which herewith is made part of these specifications.
- B. Repair surfaces and furnish all required material and labor to maintain fireproof, airtight and waterproof characteristics of the construction.
- C. Installation of equipment shall be in accordance with manufacturers' instructions.

3.3 MULTIWIRE BRANCH CIRCUITS

- A. Multiwire branch circuits shall not be used on this project. Each branch circuit shall be provided with its own dedicated neutral conductor.

3.4 MOUNTING HEIGHTS

- A. Mounting height shall be to center of box above finished floor (AFF) as noted below unless otherwise shown or indicated. Other mounting heights are indicated on the Drawings by detail. Specific dimensions AFF are shown adjacent to the symbol. Where devices are shown on architectural elevations, the elevation height shall govern.

Lighting switches	48 inches
Convenience outlets and similar devices	18 inches (see note below)
Convenience outlets in mechanical, boiler rooms and workrooms	48 inches
Motor controllers	60 inches to top
Panelboards	76 inches to top
Telephone panels	72 inches to top
Bracket lights	84 inches
Exterior WP convenience outlets	24 inches AFG
Clock hanger outlets and clocks	90 inches
Clock/speaker units	90 inches
Speakers	90 inches
Telecommunications (Data/Telephone) outlets	18 inches (see note below)

SECTION 260000 – ELECTRICAL GENERAL REQUIREMENTS

Range outlets	6 inches (or as required for access through drawer)
Dryer outlets	36 inches
Welder outlets	48 inches
Doorbell push buttons	48 inches
Wall mounted audible and/or visual appliances such as bells, horns, strobes and similar signal devices	90 inches (or 6 inches below ceiling height for ceiling heights less than 96 inches)
Manual fire alarm box	48 inches (or 48 inches to operable part where operable part of device is above centerline of device)
Fire alarm control panel	72 inches to top
Fire alarm graphic annunciator	72 inches to top
Fire alarm text annunciator	60 inches to center
Security Keypad	60 inches to center
Security Card Reader	48 inches to center
Nurse call corridor annunciator light	4 inches above door or 4 inches below ceiling
Nurse call wall mounted device stations	48 inches to top
Nurse call bathroom station and pull cord	48 inches to top, Trim cord length such that end of pull cord is 6 inches AFF
Intercom handsets and call-in switches	60 inches
Intercom administrative phone outlets	18 inches (see note below)

- B. NOTE: In locations where baseboard-heating enclosures are to be installed, outlet-mounting height shall be raised to 6 inches above top of enclosure unless otherwise noted on drawings.

3.5 CUTTING & PATCHING

- A. Obtain written permission of the Contracting Agency before cutting or piercing structural members.
- B. Wall and floor penetrations shall be in accordance with Section 260529 - Hangers and Supports.
- C. Holes through existing concrete shall be core drilled. X-ray concrete before core drilling. Do not cut rebar without specific authorization from the Contracting Agency. Seal openings with UL Listed fire resistant resilient sealant.

SECTION 260000 – ELECTRICAL GENERAL REQUIREMENTS

3.6 VAPOR RETARDER/BARRIER PENETRATIONS

- A. Provide solid blocking installed flat at all vapor retarder penetrations. Provide flat blocking at the interior face of the exterior stud wall. Blocking shall be a minimum of 4 inches larger than the penetration. Locate the penetration at the centerline of the flat blocking. Secure vapor retarder to blocking.
- B. Seal the interior of raceways penetrating the vapor retarder inside the building. Between point of sealing inside of raceway (typically at junction box or conduit) and vapor retarder penetration, seal conduit joints (connectors and couplings) with vapor retarder tape, paint on sealer or approved means acceptable to Contracting Agency.
- C. To reduce thermal transfer and ensure sealing of raceway, PVC or equivalent conduit shall be used where penetrations of building envelope are made above ground where installation of PVC is allowed by NEC.
- D. Penetrations of the building vapor retarder/barrier caused by the electrical installation shall be minimized, and where they are required, the opening in the vapor retarder/barrier shall be cut smaller than the penetrating object, so that the penetration will be a stretch fit. The penetration shall then be securely sealed with vapor barrier tape or an adhesive or caulk compatible with the surfaces being sealed.
- E. Boxes (electrical boxes, outlet boxes and telecommunication boxes, etc) penetrating walls with vapor retarder/barriers shall be sealed airtight using STI Series SSP Firestop Putty Pads. Mold putty pads around electrical junction boxes and conduits and behind vapor retarder/barrier to form an airtight seal in accordance with manufacturer's installation instructions.

3.7 FIRE RESISTIVE CONSTRUCTION

- A. Provide "tenting" or other protection acceptable to the Authority Having Jurisdiction for devices or fixtures installed in fire resistive construction (i.e., ceilings, walls, etc.) to maintain the fire resistive rating of the complete assembly.
- B. Where electrical raceways or other features penetrate fire rated building surfaces, they shall maintain the integrity of the building surface being penetrated. This shall be accomplished with either of the following methods:
 - 1. Sealing the penetration with an approved fire rated caulk or putty.
 - a. Fire rated caulk or putty: 3M Fire Barrier Caulk No. CP25, 3M Fire Barrier Moldable Putty, or as approved.
 - 2. A fire rated assembly enclosing the penetration.
 - a. Fire rated assembly: STI EZ Path, or as approved.
 - 3. Firestopping shall be applied according to the manufacturer's recommendations, and in a manner that is listed by a nationally recognized independent testing agency (such as UL) as preserving the fire time rating of the construction.

SECTION 260000 – ELECTRICAL GENERAL REQUIREMENTS

3.8 SOUND ISOLATION

- A. Where electrical raceways or other features penetrate walls that extend to structure, they shall maintain the integrity of the building surface being penetrated. Refer to the requirements of FIRESTOPPING as specified above. Note that this requirement exists regardless of whether the building surface being penetrated has a fire rating.
- B. Boxes (electrical boxes, outlet boxes and telecommunication boxes, etc) penetrating wall types that extend to structure or that contain batts shall be sealed airtight using STI Series SSP Firestop Putty Pads to reduce sound transmission. Mold putty pads around electrical junction boxes and conduits to form an airtight seal in accordance with manufacturer's installation instructions.

3.9 PROTECTIVE FINISHES

- A. Take care not to scratch or deface factory finish of electrical apparatus and devices. Repaint all marred or scratched surfaces.
- B. Provide hot dip galvanized components for ferrous materials exposed to the weather.

3.10 SEPARATION OF SYSTEMS

- A. Conductors and equipment of different voltage levels, frequency, current characteristics (AC & DC) or functions (normal vs. emergency, etc.) shall not share the same raceways or enclosures unless specifically shown on the Drawings or approved by the Contracting Agency, or inherently necessary for correct system function (i.e., at transfer switches, transformers, etc.)

3.11 TESTING

- A. Prior to final test, switches, panelboards, devices and fixtures shall be in place.
- B. Test electrical systems. They shall be free from short circuits and unintentional grounds.
- C. Make changes necessary to balance the actual electrical loads on the complete system. Arrange for balanced conditions of circuits under connected load demands, as contemplated by the normal working conditions. Final load and balance test shall be demonstrated in the presence of the Contracting Agency.
- D. Feeder cables and branch circuit cables larger than #4 AWG shall be megger tested prior to final termination. If conductor fails test, replace wiring or correct defect and retest. Perform a 1,000 volt megohm meter test between the following circuit cables in each raceway:
 - 1. A phase and B phase conductors
 - 2. A phase and C phase conductors
 - 3. B phase and C phase conductors
 - 4. A phase and Grounded (Neutral) conductors
 - 5. B phase and Grounded (Neutral) conductors
 - 6. C phase and Grounded (Neutral) conductors

SECTION 260000 – ELECTRICAL GENERAL REQUIREMENTS

7. A phase and Equipment Grounding conductors
8. B phase and Equipment Grounding conductors
9. C phase and Equipment Grounding conductors
10. Grounded (Neutral) and Equipment Grounding conductors

- E. Feeder cables shall be megger tested prior to final termination. If conductor fails test, replace wiring or correct defect and retest. Perform a 1,000 volt megohm meter test on each circuit cable rated 600 volts between the conductor and ground. Submit logs of megger readings. The insulation resistance between conductors shall not be less than 100 Megohms.
- F. Furnish one (1) copy of certified test results to the Contracting Agency prior to final inspection.

3.12 STORAGE AND HANDLING

- A. Items shall be delivered and stored in original containers, which shall indicate manufacturer's name, the brand, and the identifying number. Items subject to moisture and/or thermal damage shall be stored in a dry, heated place. Items shall be covered and protected against dirt, water, chemical, ultraviolet (UV) and/or mechanical damage.

3.13 PROTECTION OF MATERIAL AND EQUIPMENT

- A. The Contractor shall be responsible for materials and equipment to be installed under this Contract. The Contractor shall make good at his own cost any injury or damage which said materials or equipment may sustain from any source or cause whatsoever before final acceptance.
- B. Cover and protect electrical equipment during construction from dust, dirt, debris, overspray, or other construction contaminates.

3.14 CLEANING AND REPAIR

- A. Throughout the work, the Contractor shall keep the work area reasonably neat and orderly by frequent periodic cleanups.
- B. Prior to substantial completion, clean equipment and systems used during construction.
- C. Repair surfaces damaged or impacted by the work. Restore to original condition or better. Retexture surfaces to match surrounding surfaces. Repaint affected surfaces, with extent of paint to include adjacent surfaces to next wall or other clean break to avoid mismatched finish.
- D. As independent parts of the installation are completed, they may be tested and utilized during construction.

SECTION 260000 – ELECTRICAL GENERAL REQUIREMENTS

3.15 ACCESS DOORS

- A. Provide access doors required for access to equipment provided under Divisions 26, 27 and 28. Doors shall be rated for the surrounding construction. Use of access doors shall be minimized, and all locations and cosmetic features shall be submitted for approval in advance.
- B. Doors shall be finished to match surrounding surfaces as approved by the Contracting Agency.

3.16 DEMOLITION

- A. Examination Prior to Bid: Drawings involving existing conditions are based on building record drawings and/or limited field observation. Conduct a site inspection prior to submission of Bid to become thoroughly familiarized with the Scope of Work. Report discrepancies to Contracting Agency. Submission of bid certifies acceptance of existing conditions.
- B. Examination Prior to Start of Demolition: Conduct a thorough site inspection before disturbing existing installation. Verify field measurements and circuiting arrangements. Verify that abandoned wiring and equipment serve only abandoned facilities. Beginning of demolition certifies acceptance of existing conditions.
- C. Preparation:
 - 1. Disconnect electrical systems in walls, floors, ceilings, etc., scheduled for removal.
 - 2. Coordinate utility service outages with utility companies and Contracting Agency.
 - 3. Provide temporary wiring and connections to maintain existing systems in service during construction. When work must be performed on energized equipment or circuits, use personnel experienced in such operations.
 - 4. Existing Electrical Service: Maintain existing systems in service until new systems are complete and ready for service. Disable system only to make switchovers and connections. Obtain permission from Owner at least 24 hours before partially or completely disabling system. Contractor shall not be entitled to any additional compensation due to inability of Owner to grant an outage at the desired time. Minimize outage duration. Make temporary connections to maintain service in areas adjacent to work area.
 - 5. Existing Fire Alarm System: Maintain existing system in service until new system is accepted. Disable system only to make switchovers and connections. Notify Owner and applicable Fire Department Authorities at least 24 hours before partially or completely disabling system. Minimize outage duration. Make temporary connections to maintain service in areas adjacent to work area. Provide fire watch for entire affected area for entire duration of outage.
- D. Demolition of Existing Electrical Work:
 - 1. Remove, relocate, and extend existing installations to accommodate new construction.
 - 2. Remove abandoned wiring to source of supply.
 - 3. Remove exposed abandoned conduit, including abandoned conduit above accessible ceiling finishes. Cut concealed conduit flush with walls and floors, and patch surfaces.
 - 4. Disconnect abandoned outlets and remove devices. Remove abandoned outlets if conduit servicing them is abandoned and removed. Provide blank cover for abandoned outlets,

SECTION 260000 – ELECTRICAL GENERAL REQUIREMENTS

which are not removed. In finished areas, blank covers shall be blank plates matching the device plates specified for new work, unless otherwise noted or specified.

5. Disconnect and remove abandoned panelboards and distribution equipment.
6. Disconnect and remove electrical devices and equipment serving utilization equipment that has been removed.
7. Disconnect and remove abandoned light fixtures. Remove brackets, stems, hangers, and other accessories.
8. Repair adjacent construction and finishes damaged during demolition and extension work.
9. Maintain access to existing electrical installations that remain active. Modify installation or provide access panels as appropriate.
10. Restore circuits and systems to remain that are affected in any way by demolition Work, such as loads downstream of demolished equipment, switched lighting circuits where selected fixtures are demolished, etc.
11. Salvage or disposal of removed items shall be as noted on the Drawings or as directed by the Contracting Agency. Items, which the Owner does not desire to retain, shall be disposed of at a legal disposal site.

E. Cleaning and Repair:

1. Clean and repair existing materials and equipment that remain or are to be reused or are affected by this work.
2. Panelboards: Clean exposed surfaces and interior of cabinet and retorque electrical connections. Provide closure plates for vacant positions. Provide typed circuit directory showing revised circuiting arrangement.
3. Light Fixtures: Clean existing light fixtures that are required to be removed to accommodate other system installation. Use mild detergent to clean exterior and interior surfaces; rinse with clean water and wipe dry.

END OF SECTION 260000

SECTION 260519 – LOW VOLTAGE ELECTRICAL POWER CONDUCTORS AND CABLES

PART 1 - GENERAL

1.1 SUMMARY

- A. This section includes specific requirements, products, and methods of execution relating to wire and cable, 600 volts or less, approved for use on this project.
- B. Related Sections
 - 1. 260533 - Raceways and Boxes for Electrical Systems
 - 2. 260553 - Identification for Electrical Systems

1.2 REFERENCES

- A. International Electrical Testing Association:
 - 1. NETA ATS - Acceptance Testing Specifications for Electrical Power Distribution Equipment and Systems.
- B. National Fire Protection Association:
 - 1. NFPA 70 - National Electrical Code.
 - 2. NFPA 262 - Standard Method of Test for Flame Travel and Smoke of Wires and Cables for Use in Air-Handling Spaces.

1.3 SUBMITTALS

- A. Provide submittals for products in accordance with Section 260000 - Electrical General Requirements and Division 1.

1.4 QUALITY ASSURANCE

- A. Conductors shall be sized according to American Wire Gauge (AWG). Stranding, insulation, rating and geometrical dimensions shall conform to UL and ICEA specifications.

PART 2 - PRODUCTS

2.1 INSULATION TYPES

- A. Branch circuit conductors shall be 600 volt insulated, and unless otherwise noted on the Drawings, shall have the following insulation types:
 - 1. Heated indoor spaces - THHN/THWN or XHHW.

SECTION 260519 – LOW VOLTAGE ELECTRICAL POWER CONDUCTORS AND CABLES

2. Outdoors, wet locations (such as slab-on-grade), or other cold locations (such as unheated attics) - XHHW.
- B. Feeder conductors shall be 600 volt insulated, and unless otherwise noted on the Drawings, shall have the following insulation types:
 1. Heated indoor spaces - THHN/THWN or XHHW-2.
 2. Outdoors, wet locations (such as slab-on-grade), or other cold locations (such as unheated attics) - XHHW-2.
- C. Nylon-jacketed conductors such as Types THHN or THWN shall not be used in any location subject to ambient temperatures below 20° F.
- D. Special applications: Conductors in fluorescent fixture wiring channels shall have 90° C insulation rating, Types THHN, XHHW, or equal. Conductors in high temperature locations shall have one of the special insulation types suitable for the use and as permitted by the NEC.
- E. Conductors feeding Variable Frequency Drives (VFDs) and between VFDs and equipment supplied by the VFDs shall be Type XHHW-2.

2.2 FLEXIBLE CORD

- A. Flexible cord shall be Type SO or ST, or for the larger sizes, Type G.

2.3 MISCELLANEOUS

- A. Miscellaneous: Miscellaneous wire and cable for special purpose applications and not covered in the categories as indicated above or otherwise specified, shall be as shown on the plans and/or required by the intended use.

2.4 MINIMUM SIZE

- A. Unless specified otherwise minimum wire sizes shall be as follows:
 1. #12 AWG for branch circuit wiring.
 2. #20 AWG for low voltage switching circuits if part of an approved cable assembly, #18 AWG otherwise.
 3. #14 AWG for control circuit wiring.
 4. #16 AWG for light fixture whips, refer to specification section 260533 - Raceway and Boxes for Electrical Systems, for maximum fixture whip lengths.
- B. On 20A circuits, with one-way conductor lengths measured from panel to farthest receptacle, or center of lighting string (as applicable):

SECTION 260519 – LOW VOLTAGE ELECTRICAL POWER CONDUCTORS AND CABLES

1. #10 AWG for 120V circuits of 75 feet to 120 feet.
2. #8 AWG for 120V circuits of 120 feet to 200 feet.
3. #10 AWG for 277V circuits of 130 feet to 215 feet.
4. #8 AWG for 277V circuits of 215 feet to 330 feet.

- C. Similar oversizing shall apply to circuits of other ratings and/or greater lengths, as necessary to comply with the voltage drop limitations in Part 3 of this Section.
- D. Cable or conductors for fire alarm systems and other special systems shall be as described in other sections of the specifications, noted on the drawing, or recommended by the equipment manufacturer, whichever is greater.

2.5 CONDUCTORS

- A. Conductors used on this project shall be copper, solid or stranded for wiring #10 and smaller, stranded for #8 and larger.
- B. Stranded control, communication, and alarm conductors shall have compression terminations where terminated on screw terminals.

PART 3 - EXECUTION

3.1 INSTALLATION

- A. Unless otherwise noted or specified, all conductors shall be run in raceways as specified in Section 260533 – Raceways and Boxes for Electrical Systems. Raceways shall be installed as a complete system, free from obstructions, and clean before conductors are installed.
- B. Provide conductors from outlet to outlet and splice branch circuit conductors only at outlet or junction boxes. Install all conductors in a single raceway at one time and leave sufficient cable at all fittings or boxes. Keep conductors within the manufacturer's allowable tension. Do not violate minimum bending radii. Lubricants for wire pulling, if used, shall conform to UL requirements for the insulation and raceway material.
- C. Do not install Type XHHW conductors in temperatures below -10° F, or the other types in temperatures below +20° F.
- D. Conductors that extend below grade shall be suitable for wet locations (type XHHW or XHHW-2). The use of THHN below grade is not acceptable.

3.2 CONDUCTOR SUPPORT

- A. Provide conductor supports as recommended by the NEC or cable manufacturer in vertical conduits.

SECTION 260519 – LOW VOLTAGE ELECTRICAL POWER CONDUCTORS AND CABLES

3.3 SPLICING

- A. No splicing or joints are permitted in branch circuits except at outlet or accessible junction boxes. Prior to splicing, conductors shall be stripped to the exposed length recommended by the splicing device manufacturer.
- B. Utilize compression type solderless connectors when making splices or taps in conductors No. 8 AWG or larger. Provide heat or cold shrink type insulating tubing on splices and tape outer surface continuously with Scotch #88 plastic tape to secure insulation strength equal to that of the conductors joined.
- C. Utilize pre-insulated connectors, hard-shell type only, Ideal Industries, Inc., "Wing-Nut" or "Twister Pro" or "In-Sure Push-in Connectors" for splices and taps in conductors No. 10 AWG and smaller in dry locations.
- D. Utilize Ideal "Twister DB Plus", water repellent, sealant filled, UL 486D Listed connector splices and taps in conductors No. 10 AWG and smaller in damp or wet locations.
- E. Utilize "Buchanan pre-insulated crimp connectors" on stranded conductors for fire alarm control and alarm circuits.
- F. Feeder conductors shall be installed with no splices unless otherwise noted on the Drawings. Splices in feeder conductors, where specifically allowed, shall be compression type butt splices.

3.4 CONDUCTOR TERMINATION

- A. Provide power and control conductors that terminate on equipment or terminal strips with solderless lugs or T & B "Sta-Kon" terminals.
- B. Prior to termination, conductors shall be stripped to the exposed length recommended by the termination device manufacturer.

3.5 CONDUCTOR PHASE COLOR CODING

- A. Service, feeder and branch circuit conductors throughout the project secondary electrical system shall be color coded as follows:

208/120 Volts	Phase	480/277 Volts
Black	A	Brown
Red	B	Orange
Blue	C	Yellow
White	Neutral	Gray (see following)
Green	Ground	Green

SECTION 260519 – LOW VOLTAGE ELECTRICAL POWER CONDUCTORS AND CABLES

Permanently post conductor color code at each panelboard in accordance with NEC Article 210 and Section 260553 – Identification for Electrical Systems

- B. Where color coded conductors are not commercially available, colored non-aging, plastic tape may be utilized where permitted by NEC.
- C. Where neutrals of different systems exist on the project, neutral conductor identification method shall satisfy the Authority Having Jurisdiction, as to compliance with NEC Article 200. Branch circuit neutral conductors shall have a color stripe matching the corresponding phase conductor where neutral is not shared.
- D. Phases in panelboards and similar equipment shall be connected Phase A, B, C from left to right, top to bottom, or front to back.

3.6 DERATING OF CONDUCTORS

- A. Derating of conductors shall be per National Electrical Code.

3.7 VOLTAGE DROP

- A. The maximum total voltage drop shall not exceed three (3) percent in branch circuits or feeders, for a total of five (5) percent to the farthest outlet based on steady state design load conditions. Wire sizes shown on the Drawings are for minimum ampacity. Wire and conduit sizes shall be increased to limit voltage drop based upon actual lengths required in the field. Base voltage-drop calculations on NEC Chapter 9, Table 9.
- B. Secondary transformer voltage taps may be used to offset voltage drop as long as no load voltage does not exceed 125 volts phase to neutral/ground at transformer secondary.

3.8 RULES FOR OPEN WIRING ABOVE LAY-IN CEILINGS

- A. Where specifically allowed in other Sections of these specifications, open wiring not-in-conduit may be used for Class 2 special systems where installed in accessible ceiling spaces above lay-in ceilings.
- B. Open wiring installed in air-handling ceiling spaces shall be approved for the application and the specific system.
- C. Approved conduit sleeves shall be provided for all cables passing in or through walls, whether or not such sleeves are shown on the Drawings. Seal with UL Listed fire resistant resilient sealant.
- D. Wiring shall be in conduit where exposed or concealed within walls, under floors or above non-lay-in ceilings. The intent of this paragraph is to provide a complete raceway system for open wiring, using accessible ceiling spaces as a raceway.

SECTION 260519 – LOW VOLTAGE ELECTRICAL POWER CONDUCTORS AND CABLES

- E. Groups of cables common to a specific system shall be neatly bundled and routed along the edges of corridors. Cross corridors at right angles.
- F. Raceways and sleeves shall be sized in accordance with the cabling requirements for the special system involved.

3.9 TESTING

- A. Feeder and branch circuit cables larger than #4 AWG shall be megger tested prior to final termination in accordance with Section 260000 – Electrical General Requirements.

END OF SECTION 260519

SECTION 260526 – GROUNDING AND BONDING FOR ELECTRICAL SYSTEMS

PART 1 - GENERAL

1.1 SUMMARY

- A. This section includes general requirements, products and methods of execution relating to the furnishing and installation of a complete grounding system as required for this project.

1.2 REFERENCES

- A. The publications listed below form a part of this specification. The publications are referred to in the text by basic designation only, latest edition.

NUMBER	TITLE
ANSI/IEEE C2	National Electrical Safety Code
ANSI/NFPA 70	National Electrical Code
ANSI/TIA-606-C	Administration Standard for Commercial Telecommunications Infrastructure
ANSI/TIA-607-C	Generic Telecommunications Bonding and Grounding (Earthing) for Customer Premises
IEEE C62.41	Recommended Practice on Surge Voltages in Low-Voltage Surge Protective Devices
IEEE C62.42	Guide for the Application of Gas Tube Arrester Low-Voltage Surge Protective Devices
IEEE Draft P1250 (D4)	Guide on Service to Equipment Sensitive to Momentary Voltage Disturbances
IEEE Std 1100	Recommended Practice for Powering and Grounding Sensitive Electronic Equipment
IEEE Std 142	Recommended Practice for Grounding of Industrial and Commercial Power Systems
IEEE STD 81	Recommended Guide for Measuring Ground Resistance and Potential Gradients in the Earth
NFPA 70	National Electric Code (NEC) - Codebook and Handbook
REA PE-33	(1985) Shield Bonding Connectors
UL 1449 Edition 3	Surge Protective Devices (SPDs)
UL 467 Edition 6	Grounding and Bonding Equipment
UL 497 Edition 5	Protectors for Paired Conductors for Communication Circuits
UL 497A Edition 1	Secondary Protectors for Communication Circuits
UL 497B Edition 1	Protectors for Data Communication and Fire Alarm Circuits

SECTION 260526 – GROUNDING AND BONDING FOR ELECTRICAL SYSTEMS

1.3 SUBMITTALS

- A. Provide submittals for products in accordance with Section 260000 - Electrical General Requirements and Division 1. Include copies of catalog cuts, data sheets and other descriptive information for all specified materials.

1.4 MINIMUM REQUIREMENTS

- A. The minimum requirements for the system shall conform to Article 250 of the NEC.

1.5 SPECIAL REQUIREMENTS

- A. Unless specified elsewhere, the ohmic values for grounds and grounding systems from system to earth shall be as follows:
 - 1. For grounding metal enclosures and frames for electrical and electronically operated equipment -- 5 ohms maximum.
 - 2. For grounding systems to which electrical utilization equipment and appliances are connected -- 5 ohms maximum.
 - 3. For grounding secondary distribution systems, neutrals, noncurrent carrying metal parts associated with distribution systems, and enclosures of electrical equipment not normally within reach of other than authorized and qualified electrical operating and maintenance personnel -- 10 ohms maximum.

PART 2 - PRODUCTS

2.1 EQUIPMENT

- A. Grounding conductors, ground rods, and equipment required for ground systems shall be listed for the purpose intended and approved by a Nationally Recognized Testing Laboratory (NRTL), and be in accordance with U.L. 467 and as follows:
 - 1. Ground rods shall be 3/4 inch by 10 foot copper bonded steel. Erico Eritech or approved equal.
 - 2. Grounding conductors shall be copper. Unless specified otherwise, raceway for service grounding conductor shall be Schedule 40 PVC.
 - 3. Grounding conductor for telephone service entrance and telephone/data panels shall be #6 insulated copper, with 6 feet-0 inches slack cable at each panel. Comply with intersystem bonding requirements of NEC.
 - 4. Grounding conductor for television and radio distribution systems shall be #6 AWG insulated copper. Comply with intersystem bonding requirements of NEC.

SECTION 260526 – GROUNDING AND BONDING FOR ELECTRICAL SYSTEMS

2.2 CONNECTIONS

- A. Joints in grounding conductors and mats below grade shall be made with exothermic welding process or hydraulically crimped fittings listed for direct burial. Terminations above grade shall be made with solderless lugs, securely bolted in place
- B. Clamps, lugs, connectors, bonding bushings, and other such grounding and bonding items shall be:
 - 1. Labeled or listed for the purpose.
 - 2. Shall be made (both body and hardware) of hot dip galvanized steel, bronze, or other corrosion resistant alloy (except bushing throats shall be plastic).
 - 3. Shall be the products of O-Z/Gedney, T & B, Raco, or accepted equals.
 - 4. In outdoor, damp, or corrosive environments, metals for these items shall be copper (with or without tin-plating), bronze, or other corrosion resistant alloys only; O-Z/Gedney or accepted equal.

2.3 IDENTIFICATION AND LABELING

- A. Grounding conductors shall be labeled in accordance with Specification Section 260553 and TIA/EIA-606-C.

PART 3 - EXECUTION

3.1 EQUIPMENT GROUND

- A. The raceway system shall be bonded in conformity with NEC requirements to provide a continuous ground path. Where required by Code or Ordinance or where called for on the plans an additional grounding conductor shall be provided, sized in conformity with Table 250.122 of the NEC, unless larger size is noted.
- B. Provide separate grounding conductor securely bonded and effectively grounded to the enclosures at both ends of all non-metallic raceways and all flexible conduit.
- C. Provide an equipment grounding conductor sized in conformity with Table 250.122 of the NEC, unless larger size noted, for new feeder and branch circuit conduits. Where conductors are adjusted in size to compensate for voltage drop, equipment grounding conductors shall be adjusted proportionately according to circular mil area.
- D. Refeeding existing feeder/branch circuits that do not have an existing equipment grounding conductor: Bond equipment grounding conductor of new feeder or branch circuit to junction box and new and existing conduits.

SECTION 260526 – GROUNDING AND BONDING FOR ELECTRICAL SYSTEMS

3.2 CONCEALED CONNECTIONS

- A. Permanent grounding connections, where permitted by the NEC to be concealed, shall not be so concealed until inspected and accepted by the Contracting Agency. Failure to comply with this requirement shall make the Contractor liable for all expenses incurred in the process of re-exposing the connections for inspection, and subsequent repair and patching of the concealing construction, including the work of other trades. The Contractor shall schedule inspection of such connections at least one work week in advance of concealment, and shall not be entitled to any additional compensation or time extension for delays caused by inability of the Contracting Agency's representative to be available at the desired time.

3.3 CORDS AND NONMETALLIC CABLES

- A. Unless specifically permitted otherwise, cords and nonmetallic cables shall be furnished with integral Code-sized grounding conductor. Securely bond metal components and effectively ground the entire electrical system.

3.4 ELEVATOR/ESCALATOR EQUIPMENT

- A. Provide a Code sized ground conductor to the elevator/escalator equipment in accordance with "Safety Code For Elevators and Escalators", ANSI/ASME A17.1.

3.5 TELECOMMUNICATIONS GROUNDING AND BONDING SYSTEMS

- A. Telecommunications Primary Bonding Busbar (PBB):
 1. Equipment and metallic raceways located in the same room as the PBB shall be bonded to the PBB. Each piece of equipment shall be connected back to the PBB in a radial configuration, i.e., equipment ground connections shall not be "daisy chained" and then connected to PBB.
 2. TBC/TBB connections to the PBB shall be made with listed 2-hole compression connectors or exothermic type welded connections. Each piece of equipment shall be connected back to the local PBB in a radial configuration, i.e., equipment ground connections shall not be "daisy chained" and then connected to PBB.
 3. Where a panelboard for telecommunications is located in the same room as the PBB, the panelboards Alternating Current Equipment Ground (ACEG) bus or the enclosure shall be bonded to the PBB.
 4. Connect the PBB to the electrical service entrance ground (power) bus with a bolted lug connection.
- B. Secondary Bonding Busbar (SBB):
 1. Equipment and metallic raceways located in the same room as the SBB shall be bonded to the SBB.
 2. TBB connections to the SBB shall be made with listed 2-hole compression connectors or exothermic type welded connections.

SECTION 260526 – GROUNDING AND BONDING FOR ELECTRICAL SYSTEMS

3. Where a panelboard for telecommunications is located in the same room as the SBB, the panelboards Alternating Current Equipment Ground (ACEG) bus or the enclosure shall be bonded to the SBB.
- C. Rack Bonding Busbar (RBB):
- RBB connections to the SBB shall be made with listed 2-hole compression connectors or exothermic type welded connections.
- D. Alternating Current Equipment Ground (ACEG): When an electrical panelboard is located in the same room or space as the PBB or an SBB, that panelboard's ground bus shall be bonded to the PBB and/or SBB with an ACEG.
- E. Unit Bonding Conductors (UBC): Bond rack and/or cabinet mounted telecommunications equipment to the rack or cabinet RBB with a UBC.
- F. Telecommunications Equipment Bonding Conductor (TEBC): Bond RBB within racks and/or telecommunications cabinets to the local PBB or SBB with a TEBC.
- G. Conductors
1. Where insulated, the TBC and each TBB, BBC, TEBC, and UBC, shall be green, green with yellow stripe, or marked with a distinctive green color.
- H. Use of Structural steel
1. When structural steel is bonded to the building's grounding electrode system it may be used in place of a TBB, a BBC, or both. Before utilizing structural steel in place of a TBB or a BBC, building plans (including as-builts as applicable) and specifications shall be reviewed to ensure the structural steel is electrically continuous or can be made so. Additionally, the two-point continuity test as prescribed by ANSI/TIA-607-C, or equivalent, should be performed on the structural steel to verify electrical continuity and acceptable resistance along the structural steel paths used in lieu of actual bonding conductors
- I. Bonding and Connections:
1. General:
 - a. Cadweld exothermic welds. Bonds concealed or below grade shall be exothermic or hydraulically crimped fittings listed for direct burial.
 - b. Compression connections shall be made using a hydraulic 4 way compression die.
 - c. Compression connections shall be exposed unless UL Listed for direct burial.
 - d. Insulated wire splices shall be insulated with preformed wire covers.
 2. To Building Steel:
 - a. Cadweld connections to building steel.
- J. Identification and Marking:

SECTION 260526 – GROUNDING AND BONDING FOR ELECTRICAL SYSTEMS

1. Show conductors on neatly marked record drawings. Submit to the Contracting Agency.
2. Grounding conductors shall be marked per ANSI/TIA/EIA 606-C and as directed by the Contracting Agency. Mark each cable end using tie wrap style cable markers.
3. Label each PBB/SBB with a sign as depicted below:

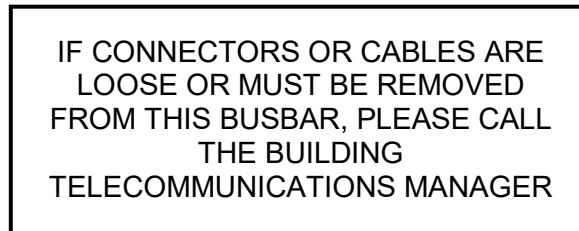

K. Performance and Test Requirements

1. Provide two-point ground/continuity testing in accordance with ANSI/TIA-607-C Chapter 9.1 for the following areas:
 - a. PBB to the electrical service entrance (power) ground in the main electrical room.
 - b. PBB/SBB to the structural metal (if present).
 - c. PBB to SBBs.
 - d. Structural metal (if present) to the electrical service entrance (power) ground.
2. The recommended maximum value for resistance between any point in the telecommunications bonding system and the building's electrical grounding system is 100 milliohms.
3. Record and submit test readings.

L.

3.6 SEPARATELY DERIVED SYSTEMS

- A. Separately derived systems shall be grounded in accordance with NEC Article 250.30.
 1. System Bonding jumper:
 - a. The system bonding jumper shall be sized in accordance with NEC Table 250.102(C)(1). Where the derived phase conductors are larger than 1100 kCMIL copper, the system bonding jumper shall have an area that is not less than 12-1/2 percent of the area of the largest ungrounded phase conductor.
 - b. The system bonding jumper shall be used to connect the equipment grounding conductor (EGC) of the separately derived system to the grounded circuit conductor.
 - c. The system bonding jumper shall be located within the enclosure of the source of the separately derived system, unless specifically noted otherwise.
 2. Grounding Electrode Conductor:

SECTION 260526 – GROUNDING AND BONDING FOR ELECTRICAL SYSTEMS

- a. The grounding electrode conductor shall be sized in accordance with NEC Table 250.66.
 - b. The grounding electrode conductor shall be used to connect the system grounded conductor or EGC to a grounding electrode or to a point on the grounding electrode system.
 - c. The grounding electrode conductor shall be connected and used to extend the connection to a grounding electrode at any of the following locations in accordance with NEC 250.68(C):
 - 1). Effectively grounded metal structural frame of a building.
 - 2). Effectively grounded interior metal water piping located not more than 5 feet from the point of entrance to the building.
 - 3). Effectively grounded rebar-type concrete-encased electrode, “Ufer Ground”, installed in accordance with NEC 250.52(A)(3) with an additional rebar section extended from its location within the concrete to an accessible location.
3. Grounding electrode:
- a. The grounding electrode shall be as near as practical to and preferably in the same area as the grounding electrode conductor connection to the system.
 - b. The building or structure grounding electrode system shall be used as the grounding electrode for the separately derived system.
4. Provide termination lugs for the co-located grounded circuit conductor, grounding electrode conductor and system bonding jumper terminations, using Listed compression-type connectors suitable for all conductors landed at each location.

END OF SECTION 260526

SECTION 260526 – GROUNDING AND BONDING FOR ELECTRICAL SYSTEMS

THIS PAGE INTENTIONALLY LEFT BLANK

SECTION 260529 – HANGERS AND SUPPORTS FOR ELECTRICAL SYSTEMS

PART 1 - GENERAL

1.1 SUMMARY

A. This Section includes:

1. General hanger and support requirements for electrical equipment, conduit and cable trays not required to be vibration and/or seismically controlled.
2. Penetrations, sleeves and seals.

B. Related Sections:

1. 260000 - Electrical General Requirements
2. 260533 - Raceways and Boxes for Electrical Systems
3. 262200 - Low Voltage Transformers
4. 262416 - Panelboards
5. 262900 - Low Voltage Controllers
6. 265000 - Lighting Fixtures
7. 270536 - Cable Trays for Electrical Systems
8. Division 3 - Cast-In-Place-Concrete
9. Division 9 - Painting

1.2 REFERENCES

- A. NFPA 70: National Electrical Code (NEC) latest legally enacted edition.

1.3 DESCRIPTION

- A. Provide general hanger and support requirements for electrical equipment, conduit and cable trays not required to be vibration and/or seismically controlled in accordance with the manufacture's written installation instructions and NFPA 70.

1.4 SUBMITTALS

- A. See Section 260000 - General Electrical Requirements for general submittal requirements

B. Product Data:

1. Provide manufacturers catalog data for each product specified. Indicate channel gauge and maximum load capacities of the selected products.
2. Manufacturer's Installation Instructions: Include assembly instructions, recommended parts and special procedures as required.

C. Shop Drawings:

SECTION 260529 – HANGERS AND SUPPORTS FOR ELECTRICAL SYSTEMS

1. Provide a single shop drawing submittal which integrates the shop drawing requirements of this section.
2. Provide shop drawings to include the following:
 - a. Housekeeping pads (coordinated with approved electrical equipment footprints and anchor point locations).
 - b. Pre-engineered and field fabricated support system details for each installation location. To include but not limited to:
 - 1). Raceway and lighting fixture support.
 - 2). Conduit and control panel support.
 - 3). Cable tray and switch box support.
 - 4). Cable tray support (single and multi-tier).
 - 5). Trapeze hangers.
 - 6). Electrical equipment support.
 - c. Equipment locations and conduit and cable tray routing coordinated with mechanical equipment and systems. Indicate routing height above finished floor.
 - d. Indicate hanger type/attachment method and hanger spacing intervals.

D. Project Record Information:

1. Indicate installed locations of hangers and supports on project as-built shop drawings.

1.5 DELIVERY, STORAGE, AND HANDLING

A. Acceptance at Site:

1. Verify products are delivered in original factory packaging and are free from damage and corrosion.
2. Replace equipment delivered to job site that does not comply with above requirements at no expense to the Owner.

B. Storage and Protection:

1. Store products in covered storage area, protected from the elements, outside the general construction area until installed.
2. Handle items to avoid damage.
3. Replace damaged items with same item in new condition.

1.6 WARRANTY

- A. Provide warranty in accordance with Section 260000 - General Electrical Requirements.

PART 2 - PRODUCTS

2.1 PRE-ENGINEERED SUPPORT SYSTEMS

- A. Manufacturers:

SECTION 260529 – HANGERS AND SUPPORTS FOR ELECTRICAL SYSTEMS

1. Unistrut
2. Super-Strut
3. B-Line
4. K-Line
5. Erico.

B. Material:

1. Cold worked steel.
2. Type 304 stainless steel: Use for PVC, liquid-tight flex, or plastic-coated conduit installed on wood construction in outdoor, damp, corrosive or marine environments.

C. Finish:

1. Heated indoor areas: Pre-galvanized zinc coating.
2. Outdoor areas: Hot dipped galvanized finish. In addition, coat hot dipped galvanized finish channel field cuts with zinc rich paint provided by the support system manufacturer.
3. Painted areas: Paintable galvanizing or phosphatized and primed.
4. Surface metal raceways: U.L. Listed epoxy coating.

D. Channel:

1. Standard Size: 1-5/8 inch x 1-5/8 inch. Gauge thickness as required for attached load.
2. Standard Hole Pattern: Slotted. Provide solid channel in exposed public areas.

E. Nuts and Hardware:

1. Channel nuts: Hardened steel (ASTM-A675 and ASTM A36).
2. Bolts, screws and nuts: Hardened steel (ASTM-A307, ASTM A563 and SAE J429).
3. Finish: Electroplated zinc.

F. Fittings: Plate steel (ASTM A635). Epoxy or electroplated zinc coating.

G. Electrical Accessories: Provide accessories from the support system manufacturer designed for the specific equipment to be supported to include but not limited to:

1. Fluorescent fixture hangers.
2. Outlet box adapters.
3. Snap-in closures.
4. Conduit connection plates.
5. Junction box adapters.
6. Strut joiners.
7. "Caddy" fasteners are permitted for support of conduit to concealed metal studs and for conduit concealed above suspended acoustical ceilings.

2.2 SLEEVES, ACOUSTICAL SEALS AND FIRE-STOPPING

A. See Part 3 - PENETRATIONS.

SECTION 260529 – HANGERS AND SUPPORTS FOR ELECTRICAL SYSTEMS

- B. Sleeves for pipes through fire rated and fire resistive floors and walls, and fire proofing: UL listed prefabricated fire rated sleeves and seals.

2.3 WALL/FLOOR PENETRATION WATER SEALS

- A. Mechanical seal consisting of interlocking synthetic rubber links shaped to continuously fill the annular space between the conduit and the wall opening.
- B. EPDM seals.
- C. 316 Stainless steel bolts and nuts.
- D. Hot-dipped galvanized or coated sleeve with full water stop flange with continuous weld on both sides.
- E. Manufacturer: Metraflex, Thunderline, Crouse-Hinds, or pre-approved equal.

PART 3 - EXECUTION

3.1 PREPARATION

- A. Prior to installation, prepare detailed shop drawings of the planned installation of hanger and support products specified by this section. Coordinate the location, type and size of hangers and supports, housekeeping pads (thickness/perimeter overhang dimensions) and roof curbs with Architectural and Structural elements utilizing the shop drawing review process.
- B. Submit shop drawings required by this section coordinated with the seismic design.
- C. Do not install hangers and supports without approved shop drawings.

3.2 GENERAL INSTALLATION

- A. Install hangers and supports in accordance with manufacturer's instructions, applicable Code requirements (NFPA 70) and approved shop drawings.
- B. See Section 260000 – Electrical General Requirements for electrical equipment wall mounting heights.

SECTION 260529 – HANGERS AND SUPPORTS FOR ELECTRICAL SYSTEMS

3.3 VIBRATION AND SEISMIC CONTROL PRODUCT INSTALLATION

- A. Install vibration isolators, seismic control and wind restraint systems in strict compliance with the manufacturer's written instructions and certified and approved application engineering installation drawings.

3.4 INSERT AND ATTACHMENT INSTALLATION

A. Inserts

1. Provide inserts or cast-in-place channels for placement in concrete formwork.
2. Provide inserts for suspending hangers from reinforced concrete slabs and sides of reinforced concrete beams.
3. Where concrete slabs form finished ceiling, locate inserts flush with slab surface.
4. Use expansion type anchor bolts with pre-cast concrete including concrete masonry units within loading limits of the pre-cast material and anchor bolt manufacturer's recommendations.
5. Where inserts are omitted, drill through concrete slab from below and provide through-bolt with recessed square steel plate and nut recessed into and grouted flush with slab.
6. Plastic screw inserts and caulked lead inserts are prohibited, except for mounting instructions and control diagrams.

B. Attach electrical equipment to structure as follows:

1. Hollow masonry: Toggle bolts.
2. Solid masonry and concrete: Preset inserts or expansion bolts.
3. Structural steel: Beam clamps which engage both sides of structural member or have retaining clips or other approved means for positive engagement.
4. Metal surfaces: Machine screws, bolts or welding.
5. Wood construction: Wood or sheet metal screws. Bugle head drywall screws or deck screws are not allowed.
6. Do not use powder actuated fasteners for anchorage in tension applications. Obtain written permission from the Owner prior to using any type of powder powered studs.
7. Attachment to plaster or gypsum board (sheet rock) not approved. Equipment shall be attached to or supported from structure.

3.5 RACEWAY INSTALLATION

- A. Support raceways using approved types of wall brackets, ceiling trapeze hangers or malleable iron straps utilizing attachment methods described above. "Perforated plumber's strap" is not permitted as a means of support.
- B. Support raceways independent of ceiling systems, piping and ductwork. Exceptions: Lighting fixtures and outlet boxes (i.e. ceiling speaker boxes) specifically designed for attachment to suspended ceiling systems

SECTION 260529 – HANGERS AND SUPPORTS FOR ELECTRICAL SYSTEMS

- C. Support EMT conduit (1-1/2 inch and smaller/dry locations) using hanger rods with spring steel fasteners.
- D. Support cable trays and multi-conduit runs independently from other support systems utilizing double hanger rods at each support point.

3.6 LIGHTING INSTALLATION

A. General

- 1. Attach safety hanger wires to lighting fixtures such that in event of a ceiling suspension system failure, no part of the fixture will drop more than 6 inches below normal ceiling height. Secure each end of each wire with a minimum of three tight wraps.

B. Fixtures (greater than 20 pounds/non-suspended ceiling applications)

- 1. Support lighting fixtures from structural members capable of supporting the total weight of the fixture and independent from electrical wiring system. Attach to steel members using approved beam clamps and rods.

C. Fixtures (suspended ceiling system applications)

- 1. Positively attach lighting fixtures to suspended ceiling grid for 100 percent of fixture weight acting in any direction using positive clamping devices that fully surround the supporting member (i.e. Caddy "IDS" or equal).
- 2. Provide supplemental safety hanger wires as follows:
 - a. Fixtures (weighting less than 56 pounds): Provide two 12 gauge wires or equivalent chains connected from the diagonal corners of the light fixture housing to the structure above. These wires may be slack.
 - b. Fixtures (weighting greater than 56 pounds): Provide full direct support from the structure above. Attach wires from within 3 inches of each corner of the fixture.
 - c. Pendant-hung lighting fixtures
 - 1). For each fixture, provide direct support from the structure above using a minimum of two 12 gauge wires, equivalent aircraft cable or an approved alternate support system without using the ceiling suspension system for direct support. Securely attach wire/cable to fixture, route through fixture stem and securely attached to structure.
 - 2). Provide loop and hook or swivel hanger assemblies fitted with a restraining device to secure stem in the support position during earthquake motion.
 - 3). Support fluorescent fixtures with flexible hanger device at the attachment point to the fixture channel to preclude breaking of the support. The motion of swivels or hinged joints shall not cause sharp bends in conductors or damage to insulation.

SECTION 260529 – HANGERS AND SUPPORTS FOR ELECTRICAL SYSTEMS

3.7 PENETRATIONS

- A. Coordinate electrical penetrations with architectural, structural and mechanical construction details prior to installation. Set sleeves in position in concrete formwork. Provide reinforcement around sleeves as required.
- B. Provide compatible materials, fasteners, adhesives, sealants, and other products required for proper installation.
- C. Penetrations through roof, exterior walls and floors shall be weather and water tight (see floor penetration seals).
- D. Firestopping: Provide UL rated firestopping assemblies for rated roof, wall and floor penetrations in accordance with Division 7.
- E. Conduit Sleeves
 - 1. Provide sleeves for conduit passing through floors, walls, ceilings, or roofs.
 - a. Fabricate sleeves in non-load bearing walls from 20 gauge galvanized sheet steel conforming to ASTM A 924/A 924M.
 - b. Fabricate sleeves in load bearing walls from standard weight galvanized steel pipe conforming to ASTM A 53/A 53M.
 - c. Provide 1/2 inch clearance between conduit and sleeve opening.
 - 2. Provide escutcheons for conduit passing through walls, floors and ceilings in finished areas, below counters and inside closets and casework subject to view when doors are open. Size escutcheons to cover sleeves. Secure escutcheons in position.
- F. Acoustical Seals
 - 1. Monolithic sound walls (i.e. poured concrete or masonry): Provide wall sleeve with approximately one-inch annular space around conduit. Pack annular space with backer rod or acoustical filler as specified in Division 7. Allow a 1 inch recess at each end of sleeve. Caulk sleeve flush with flexible sealant or fire-stopping material as specified in Division 7.
 - 2. Where acoustical wall is a two component type, such as a staggered or double stud partition, treat each component as a separate wall. Pack and seal each half of penetration sleeve as previously specified, except that only the exposed end of each sleeve portion shall be caulked with sealant or firestop. Provide adequate separation between each sleeve.
- G. Wall Penetration Seals
 - 1. Provide pre-engineered wall penetration water seal systems for exterior wall penetrations.
 - 2. Select appropriate wall penetration sealing systems based on conduit material and nominal conduit size in accordance with the manufacturer's selection charts.
 - 3. Install conduit and sealing system prior to waterproofing the wall. Grout void between water seal and outside face of foundation wall to provide continuous bearing surface for waterproofing fabric.

SECTION 260529 – HANGERS AND SUPPORTS FOR ELECTRICAL SYSTEMS

H. Floor Penetration Seals

1. Provide pre-engineered floor penetration water seal systems for conduit floor penetrations in rooms where a pipe leak/failure could result in water damage to adjacent spaces (i.e. mechanical rooms located above the ground floor or basement) and other areas as noted.
2. Extend conduit floor penetration sleeves 2 inches above finished floor.

3.8 FIELD QUALITY CONTROL

- A. Document each installation and operational step in accordance with approved shop drawings and manufacturers requirements.

END OF SECTION 260529

SECTION 260533 – RACEWAY AND BOXES FOR ELECTRICAL SYSTEMS

PART 1 - GENERAL

1.1 SUMMARY

- A. Section includes specific requirements, products, and methods of execution relating to conduit, conduit fittings, surface raceways, multi-outlet assemblies, wireways, outlet boxes, pull boxes and junction boxes approved for use on this project. Type, size and installation methods shall be as shown on Drawings, required by Code and/or specified in this Section.
- B. Related Sections
 - 1. 260519 - Low Voltage Electrical Power Conductors and Cables
 - 2. 260526 - Grounding and Bonding for Electrical Systems
 - 3. 260529 - Hangers and Supports for Electrical Systems

1.2 REFERENCES

- A. American National Standards Institute/Underwriters Laboratory
 - 1. ANSI C80.1 – Electrical Rigid Steel Conduit
 - 2. ANSI C80.3 – Steel Electrical Metallic Tubing
 - 3. ANSI C80.5 – Electrical Rigid Aluminum Conduit
 - 4. ANSI C80.6 – Electrical Intermediate Metal Conduit
 - 5. ANSI/UL 1 – Flexible Metal Conduit
 - 6. ANSI/UL 6 – Electrical Rigid Metal Conduit – Steel
 - 7. UL 6A – Standard for Electrical Rigid Metal Conduit – Aluminum and Stainless Steel
 - 8. UL 360 – Standard for Liquid Tight Flexible Steel Conduit
 - 9. UL 514A – Metallic Outlet Boxes
 - 10. UL 514B – Conduit, Tubing and Cable Fittings
 - 11. UL 651 – Standard for Schedule 40 and 80 Rigid PVC Conduit and Fittings
 - 12. UL 651A – Type EB and A Rigid PVC Conduit and HDPE Conduit
 - 13. ANSI/UL 651B – Standard for Continuous Length HDPE Conduit
 - 14. ANSI/UL 797 – Electrical Metallic Tubing – Steel
 - 15. ANSI/UL 1242 – Electrical Metal Intermediate Conduit – Steel
- B. National Electrical Manufacturers Association
 - 1. NEMA 250 – Enclosures for Electrical Equipment (1000 Volts Maximum)
 - 2. NEMA FB 1 – Fittings, Cast Metal Boxes, and Conduit Bodies for Conduit, Electrical Metallic Tubing and Cable
 - 3. NEMA OS 1 – Sheet Steel Outlet Boxes, Device Boxes, Covers and Box Supports
 - 4. NEMA RN 1 – Externally Coated Galvanized Rigid Steel Conduit and Intermediate Metal Conduit
 - 5. NEMA TC 2 – Electrical Polyvinyl Chloride (PVC) Conduit

SECTION 260533 – RACEWAY AND BOXES FOR ELECTRICAL SYSTEMS

6. NEMA TC 3 – Polyvinyl Chloride (PVC) Fittings for Use with Rigid PVC Conduit and Tubing
7. NEMA WD 6 - Wiring Device Configurations.

C. NECA (National Electrical Contractors Association) Standard of Installation.

1.3 SUBMITTALS

- A. Provide submittals for products in accordance with Section 0000 - Electrical General Requirements and Division 1.
- B. Product Data: Provide dimensions, knockout sizes and locations, materials, fabrication details, surface raceway finishes (custom factory pre-painting, color as selected by architect), and accessories.
- C. Manufacturer's Instructions: Indicate application conditions and limitations of use stipulated by Product testing agency specified under Regulatory Requirements. Include instructions for storage, handling, protection, examination, preparation, and installation of Product.

1.4 QUALITY ASSURANCE

- A. Raceways and boxes shall be standard types and sizes as manufactured by a nationally recognized manufacturer of this type of materials and be in conformity with applicable standards and UL listings.
- B. Surface raceways shall be of the latest approved design as manufactured by a nationally recognized manufacturer and shall be listed by the Underwriters' Laboratory and bear the UL label.
- C. Pull and junction boxes 50 cubic inches and smaller shall conform to specifications for outlet boxes.
- D. Pull and junction boxes larger than 50 cubic inches shall conform to U.L. Standard 50, Cabinets and Boxes.
- E. Perform Work in accordance with NECA Standard of Installation.
- F. Furnish products listed and classified by Underwriters Laboratories, Inc. as suitable for purpose specified and shown.

PART 2 - PRODUCTS

2.1 CONDUIT

- A. Conduit types specifically approved for use on this project shall be of the following types only:

SECTION 260533 – RACEWAY AND BOXES FOR ELECTRICAL SYSTEMS

1. Galvanized rigid metal conduit - GRC or RMC.
2. Intermediate metal conduit - IMC.
3. Rigid copper-free aluminum conduit.
4. Electrical metallic tubing - EMT.
5. Polyvinyl chloride conduit - PVC: May be Schedule 40 or Schedule 80, except where Schedule 80 is specifically noted or specified.
6. Flexible metal (steel) conduit - FMC or flex: In short lengths as specifically permitted.
7. Liquid-tight flexible steel conduit - LFMC: In short lengths as specifically permitted.
8. Extreme temperature liquid-tight flexible steel conduit - AT: Shall have temperature rating of -67 ° F to +220 ° F, Liguatite “ATLA”, or as approved.
9. Types specifically identified on the Drawings or in the Specifications
10. Other products not specifically approved such as ENT, MC Cable, etc., are not allowed.

2.2 FIRE ALARM CONDUIT

- A. EMT conduit utilized for fire alarm system wiring shall be factory pre-painted with a bright red topcoat, Allied Fire Alarm Red or as approved. Other conduit types utilized for fire alarm system wiring shall be identified with red paint or red tape wrapped a minimum of 4 times around the conduit every 10 feet and at each fire alarm system junction box.

2.3 CONDUIT FITTINGS

- A. Fittings utilized with rigid steel, IMC, and aluminum shall be galvanized steel or iron or copper-free aluminum and shall be threaded. Conduit bushings shall be provided and shall be of the insulated types. Where grounding bushings are required, provide insulated grounding bushings with integral pressure type ground lugs, Thomas & Betts “Blackjack”, or as approved.
- B. Couplings and connectors for EMT shall be made of steel or malleable iron. Die-cast products shall not be used. Connectors shall have insulated throats. Connectors and couplings shall be setscrew or compression type.
- C. HDPE: Joints between lengths of conduit, and between conduit and couplings, fittings and boxes shall be made by an approved method in accordance with NEC Article 353.
- D. Fittings for PVC 40 shall be polyvinyl chloride, installed using PVC solvent to form a watertight joint, except elbows (including bends exceeding 15°) shall be metallic. These metallic elbows and bends shall be of the type specified in this section for the environment in which they are to be installed.
- E. Fittings for flexible metal conduit shall be steel or malleable iron only. Throats shall be insulated.
- F. Fittings for liquid-tight flexible conduit shall be steel or malleable iron, of a type incorporating a threaded grounding cone, nylon or plastic compression ring, and a tightening gland, providing a low resistance ground connection. Throats shall be insulated.

SECTION 260533 – RACEWAY AND BOXES FOR ELECTRICAL SYSTEMS

2.4 SURFACE METAL RACEWAY

- A. The Basis of Design is equipment from Wiremold, Hubbell or Mono-Systems, to set a standard for quality and style.
- B. Large multi-circuit raceways shall be sheet metal channel 4 3/4 inches wide, 3-9/16 inches deep with metal divider to separate power and communications wiring compartments and fitted cover, suitable for use as surface metal raceway, Wiremold Series 4000, or as approved.
- C. Small surface metal raceway for individual circuit runs shall be one piece surface metal raceway of the appropriate dimensions for the conductors, Wiremold Series 500/700, or as approved.
- D. Finish: Large raceways shall be factory pre-painted a custom color as selected by the Architect. Small raceways shall be furnished with factory ivory color finish and field painted to match adjacent surfaces, unless otherwise noted on the Drawings.
- E. Large raceways shall have factory pre-punched base channel mounting fastener holes. Provide suitable backing for mounting attachment, hollow wall anchors shall not be used.
- F. Provide manufacturer's standard Fittings, Boxes, and Extension Rings:
 - 1. Wall box connectors shall be concealed entry type.
- G. Uses Permitted
 - 1. Surface metal raceway shall only be used where specifically shown on the Drawings or where conditions warrant its use, e.g., where it is required to connect to devices mounted on hard surfaces such as concrete in public areas. Concealed conduit shall be used in all other locations, e.g., above sheet rock ceilings, above linear metal ceilings, above acoustical tile ceilings, etc. Exposed conduit shall be used for devices mounted on steel structure or concrete in non-public areas. Concealed conduit shall be used in all other locations.

2.5 MULTI-OUTLET ASSEMBLY

- A. Divided multi-outlet assemblies shall be sheet metal channel 4 3/4 inches wide, 1 3/4 inches deep with metal divider to separate power and communications wiring compartments and fitted cover, suitable for use as surface metal raceway, Wiremold Series 4000, or as approved. Mounting fastener holes shall be factory pre-punched.
- B. Single channel multi-outlet assemblies shall be sheet metal channel 2 3/4 inches wide, 1 17/32 inches deep with fitted cover, suitable for use as surface metal raceway, Wiremold Series 3000, or as approved. Mounting fastener holes shall be factory pre-punched.
- C. Device fittings shall be suitable to accept a single or duplex standard electrical outlet or multi-telecommunication jack as specified in other Sections, Wiremold 4047, or as approved.

SECTION 260533 – RACEWAY AND BOXES FOR ELECTRICAL SYSTEMS

- D. Entrance fittings shall accept concealed conductor entry from the back via a flush outlet box in the wall. Entrance fitting cross section shall be identical to the sheet metal channel and shall accept the same fitted cover. Entrance fitting openings shall be factory pre-punched.
- E. Finish: Multi-outlet assemblies shall be factory pre-painted a standard color as selected by the Architect.
- F. Base channel mounting fastener holes shall be factory pre-punched in raceways. Provide suitable backing for mounting attachment, hollow wall anchors are not allowed.
- G. Fittings: Furnish manufacturer's standard couplings, elbows, outlet and device boxes, and connectors.

2.6 WIREWAY

- A. Unless otherwise noted on the Drawings, surface wireway in exposed or concealed locations shall be sheet metal channel suitable for use as a wiring trough, with hinged or screw cover, sized in accordance with the NFPA 70. Wireway shall be Square D Class 5100, 5120, 5140, as appropriate for the environment, or as approved.
- B. Wireway shall be of the NEMA Type (general purpose, oil-tight, dust-tight, rain-tight, etc.) appropriate for the environment where installed.
- C. Wireway shall be furnished without factory pre-punched concentric or eccentric conduit knockouts. Knockouts shall be field punched as required for the conduits installed
- D. Finish shall be ANSI-49 gray epoxy paint finish applied by cathodic electrodeposition over a corrosion resistant phosphate preparation.

2.7 STEEL BOXES

- A. Galvanized pressed steel boxes may be used wherever they are permitted by code, except in areas indicated in the preceding paragraph.
- B. Flush mounted, pressed steel boxes shall be equipped with external mounting brackets for attachment to framing members with screws or nails.
- C. Ceiling boxes and wall boxes for bracket lights shall be not less than 4 inch in diameter by 1 ¼ inch deep and shall have 3/8 inch malleable iron fixture studs if required.
- D. Grounding Screw: All stamped steel boxes shall have a drilled and tapped hole in the back of the box for a grounding screw.
- E. Accessories: Box covers, extension rings, bases, hanger bars, etc., for use in connection with the installation, shall be approved for use in the various applications.

SECTION 260533 – RACEWAY AND BOXES FOR ELECTRICAL SYSTEMS

2.8 TELECOMMUNICATION OUTLET BOXES

- A. Boxes for telecommunication outlets shall be a minimum of 4 inches square by 2 1/8 inches deep.
- B. Device rings for telecommunication outlets shall be single gang, minimum 5/8 inches deep, to provide a minimum internal finished depth of 2 3/4 inches.

2.9 INDOOR PULL AND JUNCTION BOXES

- A. Indoor pull and junction boxes shall conform to Article 314 of the NEC and the following requirements:
 - 1. Sheet metal boxes are approved for use in all dry, interior, nonhazardous locations.
 - 2. Boxes installed in wet locations shall be NEMA 3R unless otherwise noted.
 - 3. Furnish such boxes, whether shown or not, in order to conform to requirements for maximum pulling length and maximum number of bends allowed.
 - 4. Special boxes, as noted on the Drawings, shall be installed in areas of specific service and/or hazards.
- B. Junction box extension rings will not be accepted on new boxes. Appropriate size boxes shall be used for each application.

2.10 TELECOMMUNICATION SYSTEM PULL BOXES

- A. Telecommunication system Pull Boxes shall also conform to ANSI/EIA/TIA 569-A and the BICSI Telecommunications Distribution Methods (TDM) Manual.
- B. Dimensions:
 - 1. Pull boxes for straight through pulls shall have minimum interior dimensions in accordance with the following Table:

Maximum Trade Size Conduit	Size of Box			For Each Additional Conduit Increase Width
	Width (inches)	Length (inches)	Depth (inches)	
1 Inch	4	16	3	2 inches
1 1/4 Inch	6	20	3	3 inches
1 1/2 Inch	8	27	4	4 inches
2 Inch	8	36	4	5 inches
2 1/2 Inch	10	42	5	6 inches
3 Inch	12	48	5	6 inches
3 1/2 Inch	12	54	6	6 inches

SECTION 260533 – RACEWAY AND BOXES FOR ELECTRICAL SYSTEMS

4 Inch	15	60	8	8 inches
--------	----	----	---	----------

2.11 TELECOMMUNICATION SYSTEM SPLICE BOXES

- A. Unless otherwise specified or noted on the Drawings, splice boxes shall not be used in interior horizontal pathway conduits or interior backbone pathway conduits.
- B. Where required in a building service entrance or campus backbone pathway system, splice boxes shall be provided in accordance with the requirements of ANSI/EIA/TIA-569-A - Commercial Building Standard for Telecommunications Pathways and Spaces and the Building Industry Consulting Service International (BICSI) Telecommunications Distribution Methods Manual.

2.12 UNDERGROUND PULL AND JUNCTION BOXES

- A. Boxes set in ground shall be either precast concrete or cast iron. Covers shall be galvanized steel or cast iron, and shall be bonded to the grounding system with a stranded grounding conductor secured with a grounding lug. Provide sufficient slack to allow removal of the cover and normal working access.
- B. Underground concrete pull boxes installed in traffic areas shall be constructed to withstand AASHTO HS-20 wheel loading.

2.13 OUTDOOR ABOVE-GROUND PULL AND JUNCTION BOXES

- A. Boxes exposed to rain or installed in wet locations shall be NEMA 3R unless otherwise noted.
- B. Outdoor pull and junction boxes and conduit bodies for use with galvanized conduits shall be made of galvanized ferrous metal or cast aluminum, with integral threaded hubs or Myers-type weathertight hubs of matching composition and finish.
- C. Outdoor pull and junction boxes for use with PVC or plastic-coated conduits shall be made of fiberglass, with matching gasketed covers secured with captive monel or stainless steel screws; Hoffman A-JFG series or accepted equal. Each metallic conduit entry (including liquidtight flex) shall be provided with a bronze bond bushing and NEC-sized copper bonding jumper inside the enclosure.
- D. Furnish such boxes, whether shown or not, in order to conform to requirements for maximum pulling length and maximum number of bends allowed.

SECTION 260533 – RACEWAY AND BOXES FOR ELECTRICAL SYSTEMS

PART 3 - EXECUTION

3.1 CONDUIT USES PERMITTED

- A. Conduits shall be of the sizes shown on the Drawings or as required by the NEC, whichever is larger. Base sizes on using type XHHW for wire sizes #6 and smaller and type THHN/THWN wire for wire sizes #4 and larger. Unless otherwise noted, conduits installed in the following locations shall be of the types specifically identified only:
1. Underground or encased in concrete - rigid steel, PVC-40, IMC.
 2. Outdoors aboveground or damp locations – RMC or IMC or extreme temperature liquid-tight flexible steel conduit (where required).
 3. Dry indoor locations, concealed or exposed - RMC, rigid aluminum, EMT (where not susceptible to physical damage), flexible conduit where necessary, or IMC.
 4. Indoor locations, exposed, where susceptible to physical damage - RMC or IMC.
 5. Motor and equipment flexible connections - LFMC or FMC (when installed in plenum spaces).

3.2 RACEWAY INSTALLATION METHODS - GENERAL

- A. Concealed raceways: In occupied areas, conduit and raceways shall be concealed unless specifically noted otherwise. In service spaces (mechanical equipment rooms, electrical rooms, storage closets, etc.), approved raceways may be surface-mounted for connection to equipment in exposed surface mounted locations and in exterior locations as noted on the Drawings.
- B. Concealed raceways shall be routed as directly as possible with a minimum of bends. Concealed raceways above lay-in ceilings shall be installed a minimum of 12 inches above the ceiling grid.
- C. Exposed Raceways: Where allowed by this Specification or specifically noted on the Drawings, raceways may be mounted on the surface of walls, ceilings and other surfaces. Exposed raceways shall comply with the following:
1. Exposed raceways shall be run parallel or perpendicular to building lines and bent symmetrically or made up with standard elbows or fittings.
 2. Surface-mounted conduit, junction boxes, pull boxes, outlet boxes, etc. installed in finished areas shall be painted to match the surrounding surfaces.
 3. Connectors and fittings for raceways and conduits installed on the surface in exterior locations shall be suitable for and Listed for use in a wet location.
 4. Conduits installed in exterior locations shall be painted to match the exterior finish of the building surface to which they are attached. This shall include conduits attached via racks and stand-off brackets, or attached directly to the surface.
- D. There shall not be more than the equivalent of four quarter bends (360 degrees total) between pull points. Pull boxes added to conduit runs as a result of this requirement shall be in accordance with this Section.

SECTION 260533 – RACEWAY AND BOXES FOR ELECTRICAL SYSTEMS

- E. Conduit and tubing shall be cut square and reamed smooth at the ends and all joints made tight. Conduit threads shall be lubricated with an approved thread lubricant.
- F. Raceway for power wiring shall not be installed in the floor slab beneath telecommunication rooms.
- G. Each conduit shall enter and be securely connected to a cabinet, junction box, pull box or outlet box by means of a locknut on the outside and a locknut/bushing on the inside, or by means of a liquid-tight, threaded, self-locking, cold-weld type wedge adapter. Connections shall be made wrench tight. Locknuts shall be the bonding type with sharp edges and shall be installed in a manner that will assure a locking installation. Locknuts and bushings or self-locking adapters will not be required where conduits are screwed into threaded connections. Conduit runs shall be protected from the entrance of foreign material prior to the installation of conductors.
- H. Conduit or tubing deformed or crushed in any way shall not be installed. Conduit shall be bent only with approved bender (hydraulic or hickey). Bending machines shall be used to make field bends in conduit of 1-1/4 inch size and larger. Torches shall not be used in making conduit bends.
- I. Raceways shall be spaced at least 6 inches from parallel runs of heating system pipes, flues, other high temperature piping systems, and other heat sources. This basic spacing shall be increased if necessary to ensure that raceways experience no significant temperature rise from external sources. Raceways shall not be embedded in any spray applied insulation, fireproofing, or other materials that would restrict heat dissipation.
- J. Pull wires shall be provided in spare and unused conduits. (Nylon "jet-line" or as approved.)
- K. Conduits stubbed up out of floor and terminating inside of an enclosure shall have insulating grounding bushings installed.
- L. Raceways penetrating vapor barriers or traversing from warm to cold areas shall be sealed on the inside with a non-hardening duct sealing compound to prevent the accumulation of moisture, and shall be taped airtight to the vapor barrier on the outside. Refer to Section 260000 for additional requirements and limitations regarding penetration of vapor barriers.
- M. Raceways (particularly PVC) shall be provided with expansion joints where necessary to allow for thermal expansion and contraction. Set initial opening of expansion joints per manufacturer's instructions, to suit the ambient temperature at the time of installation.
- N. Provide flexible conduit connection at seismic joints to allow for displacement of conduit in all three axes. Provide appropriate lengths of flexible conduits at seismic joints and appropriate amounts of slack in conduit to allow movement of conduit/cablings in accordance with the design of the seismic joint. Slack shall be maintained in conduit after cabling is installed. Minimum lengths of flexible conduit and minimum amount of slack for various size conduits shall be as follows:
 - 1. 2 inch and greater: 4 foot length, 4-6 inches slack.
 - 2. 1-1/2 inch and smaller: 2 foot length, 3 inches slack.

SECTION 260533 – RACEWAY AND BOXES FOR ELECTRICAL SYSTEMS

- O. Flexible metal conduit with supplemental ground jumper shall be used for connection to vibrating equipment, or where installation conditions warrant its use with express permission. Flexible conduit shall not penetrate walls. Liquid-tight flexible conduit with supplemental ground jumper shall be used for motor and transformer connections (except utilize flexible metal conduit in plenum spaces). The ground jumper in flexible conduits shall be routed within the conduit.
- P. Length of flexible conduit shall not exceed 36 inches, except for lighting fixture whips and where specifically noted. Fixture whips shall not exceed 72 inches. Flexible conduit shall not penetrate walls or vapor barrier retarder/barrier.

3.3 RACEWAY INSTALLATION METHODS – TELECOMMUNICATIONS SYSTEMS

- A. Installation methods for telecommunication system conduits shall comply with Installation Methods – General, above, unless superseded by more stringent requirements of this section.
- B. Telecommunications conduits shall comply with the requirements of TIA/EIA-569-A and the Building Industry Consulting Service International (BICSI) Telecommunications Distribution Methods Manual. Note that some of these requirements are more stringent than the requirements of the National Electrical Code.
- C. There shall be no more than two 90-degree bends between pull points in telecommunications conduit. Pull boxes added to conduit runs as a result of this requirement shall be in accordance with this Section. If it is not practical to install a pull box in the run due to field conditions, the conduit size shall be increased to the next trade size for each additional 90-degree bend. Offsets shall be considered as equivalent to a 90-degree bend.
- D. Inside radius of conduit bends shall be at least 6 times the internal diameter of the conduit for sizes up to 2 inch trade size; 10 times the internal diameter of the conduit for sizes larger than 2 inch trade size. Where bending machine shoes are not available with the required bending radius for a one-shot field bend, factory bent, large radius 90-degree elbows shall be provided.
- E. Conduits stubbed to cable trays shall be terminated within a maximum horizontal distance of 4 inches from the tray and in a vertical zone between 1 to 6 inches above tray. Conduits shall be supported from structure within a maximum horizontal distance of 12 inches from the tray. Conduits shall be provided with a grounding bushing and shall be bonded to the cable tray with a minimum 12 AWG copper conductor.
- F. Use of flexible conduit for telecommunications shall be kept to a minimum and shall be at the discretion of the Contracting Agency. Obtain prior written approval for the use of flexible conduit. Where required due to physical considerations, flexible metal conduit may be allowed in lengths not exceeding 4 feet. If used, flexible metal conduit shall be increased by one trade size for the application used (see Conduit Sizes).
- G. Conduits entering the telecommunications room or equipment room through the floor shall be terminated 4 inches above finished floor. Conduits entering the telecommunications room or equipment room from above shall be terminated 4 inches below the finished ceiling, but in no

SECTION 260533 – RACEWAY AND BOXES FOR ELECTRICAL SYSTEMS

case shall the conduits terminate more than 12 inches above the cable pathway support or distribution frame.

- H. Conduit sleeves connecting vertically “stacked” telecommunications rooms shall be terminated 4 inches above finished floor. Conduits and cutout openings between floors shall be sealed with firestopping material that is reusable, to accommodate additions and deletions, moves and changes in the cabling system.
- I. Layout of conduits shall give consideration to nearby sources of electromagnetic energy such as electrical power wiring, large electric motors and generators, induction heaters, arc welders, variable frequency drives, etc. Maintain the greatest separation practicable between telecommunication raceways and sources of electromagnetic interference (EMI). A minimum of 5 inches of separation shall be maintained between telecommunication raceways and fluorescent lighting ballasts.
- J. Pull wires shall be provided in spare and unused conduits. (Nylon “jet-line” or as approved.)
- K. Maintain minimum separation from \leq 480V power wiring in accordance with the following table:

Condition	Minimum Separation Distance		
	< 2 kVA	2-5 kVA	> 5 kVA
Unshielded power lines or electrical equipment in proximity to open non-metal telecommunications pathways	5 inches	12 inches	24 inches
Unshielded power lines or electrical equipment in proximity to a grounded metal telecommunications conduit pathway	2.5 inches	6 inches	12 inches
Power lines enclosed in a grounded metal conduit (or equivalent shielding) in proximity to a grounded metal telecommunications conduit pathway	--	3 inches	6 inches

3.4 CONDUIT SIZES – GENERAL

- A. Minimum sizes for rigid steel, IMC, FRE, rigid aluminum and PVC-40 conduits shall be ¾ inch.
- B. Minimum size for EMT shall be ½ inch.
- C. Minimum size for flexible conduits shall be ½ inch , except fixture whips may be 3/8 inch as allowed by the NEC.

SECTION 260533 – RACEWAY AND BOXES FOR ELECTRICAL SYSTEMS

3.5 CONDUIT SIZES – TELECOMMUNICATIONS SYSTEMS

- A. Minimum size for conduit runs to outlets is 1 inch.
- B. Unless indicated otherwise, individual conduit homeruns shall serve no more than one telecommunications outlet.

3.6 STRUCTURAL COORDINATION

- A. Layout conduits in slabs to avoid compromising structural integrity. Obtain approval from Structural Engineer for maximum conduit sizes, quantities, arrangement, and placement in structural slabs.
- B. Structural members shall not be cut, drilled, or notched for raceways or other electrical features unless specifically accepted by the Contracting Agency.
- C. Underfloor raceways for slab-on-grade construction shall be embedded in the fill under the slab, not in the slab itself. Where raceways are required or permitted to be embedded in concrete, the thickness of concrete on all sides of each raceway shall not be less than 2 inches.

3.7 EXISTING CONDUIT

- A. Accurately measure the physical length of all existing underground conduits by the use of True Tape or an approved equivalent prior to the purchase or installation of any cable, wire, or innerduct. Costs incurred as a result of not obtaining accurate lengths of underground conduits prior to the purchase or installation of cable, wire, or innerduct; such as the need to replace cable, wire or innerduct, or provide an additional manhole or pull point, shall be the responsibility of the Contractor.

3.8 SURFACE RACEWAY INSTALLATION

- A. Install Products in accordance with manufacturer's instructions.
- B. Use flat-head screws, clips, and straps to fasten raceway channel to surfaces. Mount plumb and level.
- C. Provide outlets in locations shown or according to spacing specified on the Drawings. Where spacing is specified, the maximum distance from each end of the raceway to the first outlet shall not exceed one-half of the specified spacing distance. Mounting elevations shall be as noted on the Drawings or as shown on the Architectural Elevations. If a conflict exists, the elevation shown on the Architectural Elevations shall take precedence.
- D. Provide field paint touch-up with factory furnished paint to match factory pre-painted finish, for all chips, scraps, scratches, fittings and unpainted sections of the surface raceways and multi-outlet assemblies, after installation of all devices and covers are complete.

SECTION 260533 – RACEWAY AND BOXES FOR ELECTRICAL SYSTEMS

- E. Provide appropriate separate device finish plates for outlets and telecommunication jacks as specified in other Sections.
- F. Use suitable insulating bushings and inserts at connections to outlets and corner fittings.
- G. Close ends of wireway and unused conduit openings.
- H. Ground and bond raceways, multi-outlet assemblies and wireways under provisions of Section 260526 – Grounding and Bonding for Electrical Systems.

3.9 OUTLET BOX INSTALLATION

- A. Outlet boxes shall be securely fastened in position and supported independently of the conduit system.
- B. Outlet boxes located in suspended ceiling system shall be fastened to ceiling “t-bar” system with bar-hanger rods manufactured for the purpose, or from hanger rods with solid supports from structure above. “T-bar” hanger rods shall be clipped to cross-members supported by the main ceiling support members. Outlet boxes supported from the suspended ceiling system shall be provided with one safety wire attached to the box or box support clip, or two safety wires attached to the bar hanger.
- C. Boxes shall be installed true to the building lines and at equal heights in conformity with mounting heights specified in other sections of the specification.
- D. Provide the best suitable box for each outlet requirement. Extension rings shall not be used on new construction except where needed to bring an outlet box out to 1/8 inch of the finished wall or ceiling line.
- E. Boxes shall have only the holes necessary to accommodate the conduits at point of installation. All boxes shall have lugs or ears to secure covers.
- F. Boxes shall be rigidly secured in position. Recessed boxes shall be so set that the front edge of the box shall be flush with the finished wall or ceiling line, or not more than 1/8 inch back of same. This requirement is more stringent than NEC requirements.
- G. Boxes shall be accessible.
- H. Provide boxes for each application that will not violate the fire rating of the wall, floor or ceiling assembly in which the box is installed.
- I. Do not place order for floor boxes without ensuring that the Contracting Agency has positively approved submittals for the specific cover types/styles colors necessary for all applications and locations.
- J. Recessed boxes shall not be placed back-to-back in adjacent rooms. They shall be offset at least 12 inches, or greater as required by codes and standards applicable to the specific construction.

SECTION 260533 – RACEWAY AND BOXES FOR ELECTRICAL SYSTEMS

- K. Boxes (electrical boxes, outlet boxes and telecommunication boxes, etc) penetrating fire rated walls, walls with vapor retarder/barriers, wall types that extend to structure or wall types that contain batts shall be sealed airtight with approved Firestop Putty Pads to reduce sound transmission, reduce air transmission and increase fire resistance. Mold putty pads around electrical junction boxes and conduits to form an airtight seal in accordance with manufacturer's installation instructions.

3.10 JUNCTION BOX AND PULL BOX INSTALLATION

- A. Junction and pull boxes shall be installed so that covers are readily accessible and adequate working clearance is maintained after completion of the installation.
- B. Select boxes properly sized per NEC for power and lighting applications.

3.11 TELECOMMUNICATIONS SYSTEM PULL BOXES

- A. Where a pull box is required in a 1 inch conduit run, outlet boxes as specified in this Section may be used. Where a pull box is required in a conduit run 1 1/4 inch or larger, or where required for multiple raceways, the box shall be sized in accordance with the Table in this Section.
- B. Pull boxes shall be located in straight-through sections of horizontal cabling pathways (conduits). Pull boxes shall not be used for angle pulls or to accomplish changes in direction of the pathway.
- C. Multiple raceways connecting to telecommunications system pull boxes shall penetrate box walls such that they are distributed evenly along the Box wall.

3.12 TELECOMMUNICATIONS SYSTEM JUNCTION BOXES

- A. Unless otherwise specified or noted on the Drawings, junction boxes shall not be used in interior horizontal pathway conduits or interior backbone pathway conduits. Where allowed, junction boxes shall be located in a readily accessible location. Junction boxes shall not be located in above ceiling spaces.
- B. Junction boxes for telecommunication shall be hinged covered cabinets, sized in accordance with the requirements of ANSI/EIA/TIA-569-A.
- C. Junction cabinets shall have a fire-treated plywood backboard suitable for mounting punch-down style terminal blocks, in accordance with 27 2010 - Telecom Distribution System.

END OF SECTION 260533

SECTION 260553 – IDENTIFICATION FOR ELECTRICAL SYSTEMS

PART 1 - GENERAL

1.1 SUMMARY

- A. Provide identification of on equipment, raceways, boxes and conductors.
- B. Section includes:
 - 1. Nameplates
 - 2. Labels
 - 3. Wire markers
 - 4. Conduit markers
 - 5. Miscellaneous Electrical Identification
- C. Related Sections: Divisions 26, 27 and 28 Sections.

1.2 SUBMITTALS

- A. Division 1 and Section 260000 – Electrical General Requirements.
- B. Product Data:
 - 1. Submit manufacturer’s catalog literature for each product required.
 - 2. Submit electrical identification schedule including list of wording, symbols, letter size, color coding, tag number, location, and function.

PART 2 - PRODUCTS

2.1 NAMEPLATES

- A. Electrical Distribution Equipment Labels and Nameplates
 - 1. Name equipment in accordance with Contract Documents.
 - 2. Nameplates shall be laminated plastic, 0.125 inch thick, with matte finish and square corners. Minimum lettering size as noted elsewhere in this section.
 - a. Label and Nameplate Colors:
 - 1). Normal Equipment: White letters on a black background.
 - 2). Critical Branch Equipment: White letters on a red background.
 - b. Temporary markings not permitted on equipment. Repaint trims, housings, etc., where markings cannot be readily removed. Refinish defaced finishes.
 - 3. Include item designation and branch circuit designation (panel and circuit number) on disconnects, starters, equipment and device nameplates, e.g., “FAN No. 4, Circuit LA-30”).

SECTION 260553 – IDENTIFICATION FOR ELECTRICAL SYSTEMS

2.2 WIRE AND CABLE MARKERS

- A. Wire and Cable Markers: Wrap on labels, cloth tape type wire markers or tubing type for all phase, neutral and ground conductors.

2.3 LABELS

- A. Adhesive film label with clear protective overlay: Machine printed, in black, by thermal transfer process or equivalent. Minimum lettering size as noted elsewhere in this section. Overlay shall provide a weatherproof and UV resistant seal for label.

2.4 UNDERGROUND ELECTRICAL LINE PLASTIC LINE MARKER

- A. Minimum 4 inch wide plastic tape with metallic core with suitable legend describing buried electrical lines.

2.5 POWER ONE-LINE DIAGRAM

- A. Laminated, approved print of the "As-Built" power distribution system. Install in accordance with Part 3.

PART 3 - EXECUTION

3.1 NAMEPLATE INSTALLATION

- A. Install nameplate parallel to equipment lines.
- B. Mechanically fasten nameplates using threaded fasteners or pop rivets.
- C. Mechanical fasteners shall have no sharp edges or points which can damage conductors or injure personnel.
- D. Temporary markings are not permitted on equipment. Repaint trims, housings, etc., where markings cannot be readily removed. Refinish defaced finishes.
- E. No labeling abbreviations are permitted without prior approval.

3.2 DISTRIBUTION AND BRANCH PANELBOARD NAMEPLATES

- A. Nameplate shall contain the following information (minimum ½ inch height letters):
 - 1. Line 1: Panel Name as noted on drawings and schedules.
 - 2. Line 2: Shall indicate if panelboard is "NORMAL" (black background), "EMERGENCY" (red background).

SECTION 260553 – IDENTIFICATION FOR ELECTRICAL SYSTEMS

- 3. Line 4: Source from which panel is fed, “FED FROM: PANEL NH-031”.
- B. Install a 2 inch x 4 inch nameplate on each branch panelboard where a building contains distribution systems of different voltages (minimum 1/8 inch height letters):

THIS BUILDING CONTAINS TWO WIRING SYSTEMS:				
	<u>Phase A</u>	<u>Phase B</u>	<u>Phase C</u>	<u>Neutral</u>
480Y/277V	Brown	Orange	Yellow	Gray
208Y/120V	Black	Red	Blue	White

3.3 NAMEPLATE LOCATIONS

- A. Provide 1 inch minimum height letters on following equipment:
 - 1. Service disconnect(s) (red background).
 - a. Enclosures containing multiple service disconnects for utility power must clearly identify each switch as a service disconnect along with the load served.
 - b. Where the building has multiple electrical services at different locations, provide signage at each service that indicates the total number and location of all electrical service disconnects that control the electrical service to the building.
 - c. Where an on-site emergency power source is provided, a sign shall be placed at the service entrance(s) indicating the type and location of on-site emergency power sources.
- B. Provide 1/2 inch minimum height letters on following equipment:
 - 1. Secondary feeder breakers in distribution equipment. Designation as required by load served.
 - 2. Special equipment housed in cabinets, as designated on plans, on outside of door.
 - 3. Equipment housed in equipment cabinets, as designated on plans, on inside of cabinet door.
 - 4. Switchboards, motor control centers, transformers, as designated on plans, on outside of door or equipment.
 - 5. Emergency system equipment, boxes and enclosures, as designated on plans, on outside of equipment, boxes and enclosures.
 - 6. Control or low voltage system panels such as Fire Alarm, Security, Video Surveillance, etc., with the following information:
 - a. Line 1: Unique panel name as shown on the shop drawings.
 - b. Line 2: System description such as Fire Alarm, Security, etc.
 - c. Line 3: Panelboard and circuit number from which the panel is fed if applicable.
- C. Provide 1/4-inch minimum height letters on:
 - 1. Switchboards, switchgear and panelboards: Provide signage in accordance with NEC 408 indicating maximum available fault current and date of fault current calculation.
 - 2. Disconnects, starters, VFDs and contactors:

SECTION 260553 – IDENTIFICATION FOR ELECTRICAL SYSTEMS

- a. Line 1: Load Served (Use nameplate designation for source).
 - b. Line 2: Panelboard and circuit number from which the device is fed.
 - c. Line 3: Voltage, Phase, fuse size or circuit breaker size.
3. Lighting control relays, dimmer controls and remote lighting control equipment.
 4. Switches and receptacles where item controlled is not visible from the switch, or as noted on Drawings.
 5. External Power Sources: Provide 1/4 inch white letters on red background on all starters or controllers that receive power from an external source that is not de-energized by operating the associated disconnecting means.
 6. Designated electrical equipment.

3.4 RECEPTACLE AND LIGHT SWITCH DEVICE PLATES

- A. Provide 3/16 inch minimum height letters on receptacle and light switch device plates:
 1. Provide clear adhesive label (black letter on clear background) indicating branch circuit designation (panel and circuit number) on receptacle and light switch device plates, e.g., “NPA-30”). Labels shall be printed not hand written.

3.5 TELECOMMUNICATION LABELING REQUIREMENTS.

- A. Provide machine printed labels for all telecommunication racks, cabinets, patch panels, cables, outlets, etc., in accordance with ANSI/TIA/EIA-606-B. Provide labeling nomenclature in accordance with information on the Drawings or Owner’s labeling conventions. Submit labeling samples for all required applications.
- B. Machine Printed Label Requirements:
 1. PC Compatible.
 2. Can save and modify files.
 3. Fully integrated with AutoCAD.
 4. Editable Fonts and Sizes.
 5. Rotate Text and Objects.
 6. Vary Line Spacing.
 7. Ability to import graphical images.
 8. Capable for customization of layout.
 9. Re-positional labels.
- C. Basis of Design:
 1. Brady Electrical/Datacomm Worldwide (latest version of LabelMark).
 2. Cable Management Software International (latest version of docIT).
 3. Approved alternate.
- D. Labeling and color coding identification for this project shall conform to TIA/EIA-606-B for a Class **X** Administrative System.

SECTION 260553 – IDENTIFICATION FOR ELECTRICAL SYSTEMS

3.6 LABEL LOCATIONS

- A. Provide 3/16 inch minimum height letters on the following equipment:
 - 1. Security System Device Labels:
 - a. Provide label on each security field device, denoting device address. Affix label to device faceplate for ceiling-mounted devices or wall mounted devices above 8'-0" AFF. Affix label inside back box for exterior devices.
 - 2. Fire Alarm Device Labels:
 - a. Provide label on exterior surface of each initiating device denoting the unique device address corresponding to the text annunciator description. For detectors, the label shall be affixed to the base and not to the detector itself. For pull stations, the label shall be affixed to the top of the device and not to the vandal proof cover.
 - b. Provide label on each remote test station indicating description and location of device being tested.
 - c. Provide label on telecom conductors at each end denoting FACP lines for use with the digital alarm communicator transmitter (DACT).

3.7 DISTRIBUTION/BRANCH CIRCUIT PANELBOARD CIRCUIT LABELING

- A. Distribution Panels and Branch Circuit Panelboard Directories: Provide neatly typed schedule (odd numbered circuits on left side or top, even on right side or bottom) under plastic jacket or protective cover to protect the schedule from damage or dirt. Securely mount on inside face of panelboard door. Define briefly, but accurately, nature of connected load (i.e., Lighting Room 201, Receptacles Janitor Room 155, Etc.) as approved. Sequentially numbered schedules shall not be used.
- B. Use final approved room numbers from finished construction (not necessarily as indicated on the drawings).
- C. Provide numbering for terminals on terminal strips in the terminal enclosure that identifies the origin, function and destination of each conductor.
- D. Install wire marker for each conductor inside panelboards (phase, neutral and ground conductors). Locate label within 6 inches of termination. Labels shall be visible with panel dead front installed.
- E. Provide updated circuit directory in existing panelboards that are modified. Install directory in panelboard in protective cover and submit electronically in the O&M Manual.

3.8 WIRE MARKER INSTALLATION

- A. Install wire marker for each conductor (phase, neutral and ground conductors) at panelboards, pull boxes, outlet and junction boxes, and each load connection. Locate label within 6 inches of termination in panelboards. Labels shall be visible with panel dead front installed.

SECTION 260553 – IDENTIFICATION FOR ELECTRICAL SYSTEMS

- B. Wire markers are not required on conductors in a pull or junction box that contains only an individual branch circuit, however, source panel and circuit number shall be noted on pull or junction box cover as noted elsewhere in this section.
- C. Fire Alarm Circuits: Provide cable markers showing Notification Appliance Circuit (NAC) or Signaling Line Circuit (SLC) loop identification number at fire alarm junction boxes and pullboxes.
- D. Security System Cables: Install wire marker for each cable at cabinets, pull boxes, junction boxes, and each load connection. Wire ID number shall be as shown on security system shop drawings.
- E. Power Circuits: Panelboard name and branch circuit or feeder number.
- F. Control Circuits: Control wire number as indicated on schematic and/or shop drawings.
- G. Color Code:
 - 1. Color code phases, neutral, and ground per NEC requirements and Section 260519 – Wire and Cable.
 - 2. Color code all low voltage system wiring in accordance with applicable Sections.

3.9 TRANSFORMERS

- A. Nameplate shall contain the following information:
 - 1. Line 1: Transformer Name as noted on drawings and schedules.
 - 2. Line 2: KVA Rating/Primary/Secondary Voltage.
 - 3. Line 3: Source from which transformer is fed, “FED FROM: PANEL NHA”
 - 4. Line 4: Destination of transformer feed, “FEEDS: PANEL NPA.
- B. When the transformer disconnect is located in a remote location, the disconnecting means shall be labeled to reference the transformer location in accordance with NEC Article 450.

3.10 MISCELLANEOUS ELECTRICAL IDENTIFICATION

- A. Junction Boxes: Mark the circuit number(s) and panel source of wiring on all junction boxes with sheet steel covers. Mark with indelible black marker. On exposed junction boxes in finished areas mark on inside of cover.
- B. Conduits
 - 1. Mark all conduits entering or leaving panelboards with indelible black magic marker with the circuit numbers of the circuits contained inside.
 - 2. Fire Alarm System: Paint fire alarm conduits with a 6 inch band 10 feet on center with red paint where installed in concealed accessible location (or provide red conduit in accordance with Section 260519 – Low Voltage Electrical Power Conductors and Cables and Section

SECTION 260553 – IDENTIFICATION FOR ELECTRICAL SYSTEMS

260533 – Raceways and Boxes for Electrical Systems. Where raceway is installed in exposed locations it shall be painted to match the adjacent surface.

3. Empty Conduits: Provide tags with typed description of purpose, and location of opposite end, wired to each end of conduits.

C. Junction Boxes

1. Markings shall be made with indelible black marker.
2. On exposed junction boxes in finished areas markings shall be on inside of cover.
3. Mark the circuit numbers of wiring on all junction boxes with sheet steel covers.
4. Mark all Special System junction boxes with sheet steel covers with appropriate system designation, e.g., "Intercom", "Clock", "Telecom", "Video Surveillance", etc. Fire Alarm System: Paint all fire alarm junction boxes inside and out with red paint where installed in concealed accessible location. Where installed in exposed locations paint boxes to match the adjacent surface.

D. One-Line Diagram: Mount behind protective cover (1/8-inch minimum thickness clear Plexiglas) in accessible location at main switchboard.

E. Exterior underground power, control, signal and communications lines.

1. Install continuous underground plastic line marker located directly above line at 6 to 8 inches below finished grade. Where width of multiple lines installed in a common trench or concrete envelope exceeds 16 inches provide additional markers.
2. Install markers for both direct buried and conduit encased conductors.
3. Label each underground conductor with its circuit number or identification tag.

F. Provide a label at the fire alarm control panel that identifies the panelboard and circuit number that supplies the control panel. Provide a red label adjacent to the circuit breaker inside the panelboard that clearly identifies the circuit breaker that feeds the control panel in accordance with NFPA requirements.

3.11 CODE REQUIRED MARKINGS AND WARNINGS:

A. Provide all placards, markings and identification systems required by Code and/or the Contract Documents, such as (but not limited to):

1. Arc Flash.
2. Series Rated Systems.
3. Conductor insulation color identification.
4. Special conductor identification and legends.
5. Multiple services placards.
6. Emergency systems markings.
7. Emergency source grounded circuit conductor connected to a grounding electrode at a location remote from the emergency source: Provide a sign at the grounding location identifying all emergency and normal sources connected at that location.

SECTION 260553 – IDENTIFICATION FOR ELECTRICAL SYSTEMS

8. Warning messages shall include an appropriate plain language imperative command, such as "DANGER HIGH VOLTAGE - KEEP OUT".
9. Available Fault Current: Service equipment shall be legibly marked in the field with the maximum available fault current. The field marking(s) shall include the date the fault calculation was performed and shall be of sufficient durability to withstand the environment involved.

3.12 CLEARANCE STRIPING

- A. For electrical equipment located in areas with uncarpeted floors, the clearances dictated by NEC Article 110 shall be indicated by two inches wide colored striping on the floor.
- B. Striping shall be of a bright color (typically red or yellow) that contrasts with the floor color, and shall be applied by the most durable process that is commercially available for the particular floor finish. Examples are: epoxy paint on concrete floors, and colored tile segments in composition tile floors. Striping color and method shall be subject to approval by the Contracting Agency.
- C. On the floor immediately inside the striping, stencil in two inch block letters the statement: "ELECTRICAL CLEARANCE – NO STORAGE." For floor types where painted stenciling is not feasible or sufficiently durable, this message shall instead be posted on the wall below the equipment as an engraved nameplate of the type specified in this Section, with 1/2-inch lettering. Note the specific clearance requirements on the engraved nameplate.

END OF SECTION 260553

SECTION 262416 – PANELBOARDS

PART 1 - GENERAL

1.1 SUMMARY

- A. This section includes general provisions, products, and methods of execution relating to branch circuit panelboards approved for use on this project. Type, size, ratings, etc., shall be as shown on the plans and in accordance with UL Standards 50 and 67.
- B. Related Sections:
 - 1. 260526 - Grounding and Bonding for Electrical Systems
 - 2. 260553 - Identification for Electrical Systems
 - 3. 262800 - Low Voltage Circuit Protective Devices

1.2 REFERENCES

- A. The panelboards and circuit breakers referenced herein shall be designed and manufactured according to the latest revision of the following specifications.
 - 1. NEMA PB 1 - Panelboards
 - 2. NEMA PB 1.1 - Instructions for Safe Installation, Operation and Maintenance of Panelboards Rated 600 Volts or Less.
 - 3. NEMA AB 1 - Molded Case Circuit Breakers
 - 4. NEMA KS 1 - Enclosed and Miscellaneous Distribution Equipment Switches (600 Volts Maximum)
 - 5. UL 50 - Enclosures for Electrical Equipment
 - 6. UL 67 - Panelboards
 - 7. UL 98 - Enclosed and Dead-front Switches
 - 8. UL 489 - Molded-Case Circuit Breakers and Circuit Breaker Enclosures
 - 9. NFPA 70 - National Electrical Code (NEC)
 - 10. ASTM - American Society of Testing Materials
 - 11. IBC – International Building Code – Seismic compliance requirements
 - 12. NFPA 5000 – NFPA Building Code – Seismic compliance requirements
 - 13. ASCE 7 – American Society of Civil Engineers, Minimum Design Loads for Buildings and Other Structures – Seismic compliance requirements
 - 14. ICC ES AC156 – International Code Council Evaluation Services Acceptance Criteria for Seismic Qualification by Shake-Table Testing of Nonstructural Components and Systems – seismic testing protocol

1.3 SPECIAL REQUIREMENTS

- A. Special features such as integral surge protective devices (SPDs), etc., shall be provided as required by this Section and as noted on the Drawings or on the panel schedules.
 - 1. Trims shall be furnished to be compatible with type of mounting.
 - 2. “Door-in-door” construction shall be furnished on all panelboards unless otherwise noted.

SECTION 262416 – PANELBOARDS

1.4 SUBMITTALS

- A. Provide submittals for products in accordance with Section 260000 - Electrical General Requirements and Division 1.
- B. Submit for approval manufacturer's shop drawings to show weights, dimensions, mounting arrangements, interconnecting diagrams, schedules of overcurrent devices, voltage ratings, and specified accessories.

1.5 QUALITY ASSURANCE

- A. Panelboards shall be of the latest approved design as manufactured by a nationally recognized manufacturer and shall be listed by the Underwriters' Laboratory and shall bear the UL label.

PART 2 - PRODUCTS

2.1 BASIS OF DESIGN

- A. The Basis of Design is equipment from Square D Company to set a standard for quality. Equipment from Eaton, Siemens Energy & Automation, General Electric, or alternative systems will be considered providing that sufficient documentation is provided to satisfy the CONTRACTING AGENCY that the equipment meets the requirements of the Specifications, and matches the Basis of Design on all points which are pertinent to the Project.

2.2 CABINETS AND FRONTS

- A. Panelboard assembly shall be enclosed in a steel cabinet. Fronts shall include doors and have flush, brushed stainless steel, cylinder tumbler type locks with catches and spring-loaded door pulls. All panelboard locks shall be keyed alike. Fronts shall have adjustable, indicating trim clamps that shall be completely concealed when the doors are closed. Doors shall be mounted by completely concealed steel hinges. Fronts shall not be removable with door in the locked position. A circuit directory frame and card with a clear plastic covering shall be provided on the inside of the door. The directory card shall provide a space at least 1/4 inch high by 3 inch long or equivalent for each circuit. The directory shall be typed to identify the load fed by each circuit. Fronts shall be of code gauge, full finished steel with rust inhibiting primer and baked enamel finish. Cabinets shall be labeled in accordance with the Drawings and Section 260000 - Electrical General Requirements.
- B. "Door-in-door" construction shall be furnished on panelboards unless otherwise noted.

2.3 SAFETY BARRIERS

- A. The panelboard interior assembly shall be dead front with panelboard front removed.

SECTION 262416 – PANELBOARDS

2.4 BUS ASSEMBLY

- A. Panelboard bus structure and main lugs or main breaker shall have current ratings as shown on the panelboard schedule. Bus structure shall allow 1, 2 and 3-pole breakers of various frame sizes to be mounted in any location and in any combination up to the capability of the panel.

2.5 SHORT CIRCUIT CURRENT RATING

- A. Each panelboard, as a complete unit, shall have a short circuit current rating (SCCR) equal to or greater than that shown on the panelboard schedule, or as necessary to comply with the requirements stated on the power one-line diagram. The SCCR rating shall not, in any case, be less than 10,000 Amps at 240 volts, and 14,000 Amps at 480 volts.

2.6 PROTECTION DEVICES

- A. Circuit breakers shall individually comply with Section 262800 – Low Voltage Circuit Protective Devices. The type to be furnished shall be as shown on the plans. If no withstand rating is specified, minimum requirements shall be as necessary to comply with the preceding requirements.

2.7 NEUTRAL TERMINAL BAR

- A. Panelboards shall be equipped with an insulated neutral terminal bar.

2.8 EQUIPMENT GROUNDING TERMINAL BAR

- A. Panelboards shall be equipped with an equipment grounding terminal bar to terminate equipment grounding conductors.

2.9 HANDLE LOCK-OFF EQUIPMENT

- A. Circuit breakers serving as the required disconnecting means for appliances or other equipment shall be equipped with equipment to allow the breaker to be padlocked in the "off" position.

PART 3 - EXECUTION

3.1 INSTALLATION

- A. Verify mounting arrangements for each location shown on the plans. Where cabinets are recessed, verify adequate thickness of wall and make arrangements for furring or trim as required. In general, conduits shall enter the top or bottom of panel.
- B. Provide additional wire gutters or pull boxes to facilitate orderly entry of conduits into cabinets. Bundle and support wires and arrange them in an orderly manner in the designated wire gutters.

SECTION 262416 – PANELBOARDS

- C. Panelboards shall not be used for pull boxes for wiring not terminating in the panelboard.

3.2 SPARE CONDUITS

- A. Provide spare conduits from flush mounted panels into accessible ceiling or floor spaces as follows:

No. of Poles (Spares + Spaces)	Spare Conduits
1 - 3	One 3/4 inch
4 - 6	Two 3/4 inch
7 or more	Two 3/4 inch, One 1 inch

3.3 PANELBOARD LABELS

- A. In addition to applicable NEC requirements for emergency systems, series rated applications, etc., label panelboards in accordance with Section 260553 – Identification for Electrical Systems.
1. First line shall be panelboard name.
 2. Second line shall be voltage and phase.
 3. Third line shall indicate if panelboard is "NORMAL" (black background), or "STANDBY" (yellow background) or "EMERGENCY" (red background).
 4. Fourth line shall be source from which panel is fed, "FED FROM: PANEL NH031".
- B. Install a 2 inch x 4 inch nameplate on each branch panelboard where a building contains distribution systems of different voltages:

THIS BUILDING CONTAINS TWO WIRING SYSTEMS:				
	<u>Phase A</u>	<u>Phase B</u>	<u>Phase C</u>	<u>Neutral</u>
480Y/277V	Brown	Orange	Yellow	Gray
208Y/120V	Black	Red	Blue	White

3.4 FIELD QUALITY CONTROL

- A. Inspect complete installation for physical damage, proper alignment, anchorage, and grounding.
- B. Check tightness of bolted connections and circuit breaker connections using calibrated torque wrench or torque screwdriver per manufacturer's written specifications.

3.5 SHORT CIRCUIT INFORMATION/PANEL SCHEDULES

- A. Refer to the drawings for Short Circuit Information and Panel Schedules.

SECTION 262416 – PANELBOARDS

END OF SECTION 262416

SECTION 262726 – WIRING DEVICES

PART 1 - GENERAL

1.1 SUMMARY

- A. This section includes general provisions, products and methods of execution relating to line voltage wiring devices for use on this project.
- B. Related Sections
 - 1. 260533 - Raceway and Boxes for Electrical Systems

1.2 REFERENCES

- A. National Electrical Manufacturers Association:
 - 1. NEMA WD 1 - General Requirements for Wiring Devices.
 - 2. NEMA WD 6 - Wiring Devices-Dimensional Requirements.

1.3 SUBMITTALS

- A. Provide submittals for products in accordance with Section 260000 - Electrical General Requirements and Division 1.
- B. Do not place order for devices, plates, etc., without ensuring that the Contracting Agency has positively approved submittals for the specific colors necessary for all applications and locations. Note that the selection of one color for general use does not rule out the selection of other colors for special applications or for aesthetic reasons.

1.4 QUALITY ASSURANCE

- A. Manufacturers mentioned and catalog numbers specified are for establishment of type, configuration and quality. Other manufacturers and types may be submitted for approval.

PART 2 - PRODUCTS

2.1 MANUFACTURERS

- A. Catalog numbers shown are Hubbell unless noted otherwise. Equal devices manufactured by Arrow Hart (by Cooper Wiring Devices), Pass and Seymour, Leviton and Bryant are acceptable. Provide all similar devices of same manufacturer.

SECTION 262726 – WIRING DEVICES

2.2 SWITCHES

- A. Provided switches as called for on the Drawings or as required by the application.

2.3 RECEPTACLES

- A. Insofar as commercially available, receptacles shall be of nylon construction. Provide grounding type receptacles as follows, or as required to match equipment furnished in this or other divisions.

Single Phase, 3-Wire Devices		
15A-125V	CAT. NO. HBL5262W	NEMA #5-15R
15A-125V GFCI	CAT. NO. HBL GF15W	NEMA #5-15R
15A-250V Single	CAT. NO. HBL5661W	NEMA #6-15R
Clock hanger 125V	CAT. NO. HBL5235W	NEMA #5-15R
20A-125V USB Charger Tamper Resistant	CAT. NO. HBL USB20X2	NEMA #5-20R
20A-125V	CAT. NO. HBL5362W	NEMA #5-20R
20A-125V GFCI	CAT. NO. HBL GF-20W	NEMA #5-20R
20A-125 SPD	CAT. NO. HBL5362SA	NEMA #5-20R
20A-125V Tamper Resistant	CAT NO. HBL5362WTR	NEMA #5-20R
20A-125V Tamper Resistant (hospital grade)	CAT NO. HBL8300SGWA	NEMA #5-20R
20A-250V Single	CAT. NO. HBL5461W	NEMA #6-20R
30A-250V Dryer	CAT. NO. RR430F	NEMA #14-30R
50A-250V Range	CAT. NO. RR450F	NEMA #14-50R

- B. Outlets requiring ratings and configurations different from those listed above shall be provided as shown on the plans and/or required by the equipment served.

2.4 DEVICE COLOR

- A. Device color shall be ivory, unless otherwise noted.

2.5 DEVICE PLATES

- A. Device plates shall be made of Lexan unless otherwise noted. Device plate color shall be ivory, unless otherwise noted.

SECTION 262726 – WIRING DEVICES

- B. Label receptacle and light switch plates in accordance with Section 260553 – Identification for Electrical Systems.

PART 3 - EXECUTION

3.1 INSTALLATION

- A. Install wiring devices indicated complete with cover plates. Cover plates shall fit snugly against finished surfaces and line up true with adjacent building lines, and be symmetrical in location and appearance.
- B. Switches shall be installed so their handles move in a vertical plane.
- C. Door swings shall be checked and, if necessary, switches shall be relocated to place them on the strike side of the door.
- D. Unless otherwise noted on the drawings, receptacles shall be installed in the vertical position with the grounding pin down unless wording on the face of the device requires other mounting.
- E. Receptacles identified as Ground-Fault Circuit Interrupter (GFCI) type shall be provided as individual GFCI receptacles.

END OF SECTION 262726

SECTION 262726 – WIRING DEVICES

THIS PAGE INTENTIONALLY LEFT BLANK

SECTION 262800 – LOW VOLTAGE CIRCUIT PROTECTIVE DEVICES

PART 1 - GENERAL

1.1 SUMMARY

- A. Section Includes:
 - 1. Thermal Magnetic Molded Case Circuit Breakers.
 - 2. Electronic Trip Molded Case Circuit Breakers.
 - 3. Fusible switches and fuses.

- B. Related Sections:
 - 1. 262416 - Panelboards

1.2 REFERENCES

- A. The circuit breaker(s) referenced herein shall be designed and manufactured according to the latest revision of the following standards.
 - 1. ANSI/NFPA 70 - National Electrical Code (NEC).
 - 2. NEMA AB 1 - (National Electrical Manufacturers Association) Molded Case Circuit Breakers and Molded Case Switches.
 - 3. UL 489 - (Underwriters Laboratories Inc.) Molded Case Circuit Breakers and Circuit Breaker Enclosures.
 - 4. UL 943 - Standard for Ground Fault Circuit Interrupters.
 - 5. UL 1053 – Ground Fault Sensing and Relaying Equipment.
 - 6. CSA C22.2 No. 5 - (Canadian Standard Association) Molded Case Circuit Breakers, Molded Case Switches and Circuit Breaker Enclosures.
 - 7. Federal Specification W-C-375 - Circuit Breakers, Molded Case; Branch Circuit and Service.
 - 8. Federal Specification W-C-865 - Fusible Switches.
 - 9. IEC 60947 – Low Voltage Switchgear and Control Gear – Part 2: Circuit Breakers.
 - 10. IEC 61000-4 Series – Electromagnetic Compatibility.

1.3 SYSTEM DESCRIPTION

- A. Provide overcurrent protective devices as specified herein and as shown on schedules and/or drawings.

1.4 SUBMITTALS

- A. Provide submittals for products in accordance with Section 260000 - Electrical General Requirements and Division 1.

SECTION 262800 – LOW VOLTAGE CIRCUIT PROTECTIVE DEVICES

- B. Product Data: Submit product data showing material proposed. Submit sufficient information to determine compliance with the Drawings and Specifications. Submit product data for each type of overcurrent protective device, ground fault protector, accessory, and component indicated. Include dimensions and manufacturer's technical data on features, performance, electrical characteristics, ratings, and finishes.
- C. Provide outline drawings with dimensions, and ratings for voltage, amperage and maximum interruption. Include instructions for circuit breaker mounting, trip unit functions and adjustments, trouble shooting, accessories and wiring diagrams.
- D. Coordination data to check protective devices: Manufacturer shall provide electronic and hard copy time/current characteristic trip curves (and I_p & I^2t let through curves for current limiting circuit breakers) for each type of circuit breaker.
- E. Provide information required to verify compliance with the short circuit withstand and interrupting ratings, as shown on the Drawings or further stated in these Specifications.
- F. Arc Flash Hazard Analysis Study: Provide an Arc Flash Hazard Analysis Study for the revised electrical distribution system provided under this project per the requirements set forth in NFPA 70E-Standard for Electrical Safety in the Workplace. The arc flash hazard analysis shall be performed according to the IEEE 1584 equations that are presented in NFPA 70E, Annex D.

1.5 QUALITY ASSURANCE

- A. Devices shall be the latest approved design as manufactured by a nationally recognized manufacturer and in conformity with applicable standards and UL listings.
- B. Nationally Recognized Testing Laboratory (NRTL) Labeling: Electrical equipment and conductors installed in the State of Alaska must be "Approved," "Certified," "Identified," or "Listed" and "Labeled" to establish that the electrical equipment is safe, free of electrical shock and fire hazard, and suitable for the purpose for which it is intended to be used. The manufacturer shall have the specific authorization of one of the Occupational Safety and Health Administration (OSHA) approved Nationally Recognized Testing Laboratories (NRTLs) in accordance with the applicable national standards to label the equipment as suitable.
- C. The overcurrent protection device manufacturing facility shall be Registered by Underwriters Laboratories Inc. to the International Organization for Standardization ISO 9000 Series Standards for quality.

SECTION 262800 – LOW VOLTAGE CIRCUIT PROTECTIVE DEVICES

PART 2 - PRODUCTS

2.1 PRODUCT

- A. The Basis of Design is equipment from Square D by Schneider Electric to set a standard for quality. Equipment from Eaton, Seimens Energy & Automation, General Electric, or alternative systems will be considered providing that sufficient documentation is provided to the Contracting Agency that the equipment meets the requirements of the Specifications, and matches the Basis of Design on all points that are pertinent to the Project.

2.2 MOLDED CASE CIRCUIT BREAKERS

A. General Characteristics:

1. Circuit breakers shall be constructed using glass reinforced insulating material. Current carrying components shall be completely isolated from the handle, and the accessory mounting area.
2. Circuit breakers shall have an over center, trip free, toggle operating mechanism which shall provide quick make, quick break contact action. The circuit breaker shall have common tripping of all poles.
3. The circuit breaker handle shall reside in a tripped position between on and off to provide local trip indication. Circuit breaker escutcheon shall be clearly marked on and off in addition to providing international I/O markings.
4. The maximum ampere rating and UL, IEC, or other certification standards with applicable voltage systems and corresponding interrupting ratings shall be clearly marked on face of circuit breaker.
5. Each circuit breaker shall be equipped with a push-to-trip button, located on the face of the circuit breaker to mechanically operate the circuit breaker tripping mechanism for maintenance and testing purposes (except Type QO/EDB/EGB/EJB).

B. Trip Unit:

1. General:
 - a. MCCBs shall be equipped with thermal magnetic trip units.
 - b. Circuit breakers with permanent trip units shall be UL listed for reverse connection without restrictive line and load markings and shall be suitable for mounting in any position.
 - c. The trip units shall not augment overall circuit breaker volume.
2. Thermal Magnetic
 - a. Basis of Design: PowerPact Q, H and J Frame, FA, LA, and LH as manufactured by Square D by Schneider Electric.
 - 1). General:
 - a) Thermal trip elements shall be factory preset and sealed. Circuit breakers shall be true RMS sensing and thermally responsive to protect circuit conductor(s) in a 104 F (40 C) ambient temperature. Circuit breaker frame

SECTION 262800 – LOW VOLTAGE CIRCUIT PROTECTIVE DEVICES

sizes above 150 amperes shall have a single magnetic trip adjustment located on the front of the circuit breaker

- 2). Type QO (for use in NQ Series Panelboards) and Type EDB/EGB/EJB (for use in NF Series Panelboards) as manufactured by Square D by Schneider Electric.
 - a) Breakers shall have two forms of visible trip indication. The breaker handle shall reside in a position between ON and OFF. In addition, there shall be a red VISI-TRIP® indicator appearing in the clear window of the circuit breaker housing.

PART 3 - EXECUTION

3.1 INSTALLATION

- A. Installation shall be in accordance with reviewed product data, final shop drawings, manufacturer's written recommendations, and as indicated on the Drawings. Install circuit breakers in accordance with manufacturer's instructions, the National Electrical Code and applicable local codes.
- B. Size devices as shown and specified, or as required by the load being served.

3.2 ADJUSTMENTS

- A. Circuit breaker pick-up level and time delay settings shall be adjusted to values indicated on the Drawings or schedules or as recommended by the manufacturer.

3.3 ARC FLASH LABELING

- A. Provide arc flash labels for equipment that provides all of the following:
 1. Nominal system voltage
 2. Arc flash boundary
 3. At least one of the following:
 - a. Available incident energy level or arc flash PPE Category in NFPA 70E, Standard for Electrical Safety
 - b. Minimum arc rating of clothing
 - c. Site specific level of PPE

3.4 FIELD QUALITY CONTROL

- A. Document each installation and operational step in accordance with approved shop drawings and manufacturer's requirements.

END OF SECTION 262800

SECTION 262900 – LOW VOLTAGE CONTROLLERS

PART 1 - GENERAL

1.1 SUMMARY

- A. This section includes general requirements, products, and methods of execution relating to manual and magnetic motor starters provided in this and other Divisions. Overloads shall be furnished and installed in Divisions 26, 27 and 28.
- B. Related Sections:
 - 1. 260553 - Identification for Electrical Systems

1.2 REFERENCES

- A. National Electrical Manufacturers Association:
 - 1. NEMA AB 1 - Molded Case Circuit Breakers and Molded Case Switches.
 - 2. NEMA FU 1 - Low Voltage Cartridge Fuses.
 - 3. NEMA ICS 2 - Industrial Control and Systems: Controllers, Contactors and Overload Relays, Rated Not More Than 2000 Volts AC or 750 Volts DC.
 - 4. NEMA ICS 5 - Industrial Control and Systems: Control Circuit and Pilot Devices.
 - 5. NEMA ICS 6 - Industrial Control and Systems: Enclosures.
 - 6. NEMA KS 1 - Enclosed and Miscellaneous Distribution Equipment Switches (600 Volts Maximum).
- B. International Electrical Testing Association:
 - 1. NETA ATS - Acceptance Testing Specifications for Electrical Power Distribution Equipment and Systems.

1.3 SUBMITTALS

- A. Provide submittals for products in accordance with Section 260000 - Electrical General Requirements and Division 1.

1.4 QUALITY ASSURANCE

- A. Equipment shall be of the latest approved design as manufactured by a nationally recognized manufacturer and in conformity with the governing standards.

SECTION 262900 – LOW VOLTAGE CONTROLLERS

PART 2 - PRODUCTS

2.1 BASIS OF DESIGN

- A. The Basis of Design is equipment from Square D by Schneider Electric to set a standard for quality. Equipment from alternative systems will be considered providing that sufficient documentation is provided to satisfy the CONTRACTING AGENCY that the equipment meets the requirements of the Specifications, and matches the Basis of Design on all points which are pertinent to the Project.

2.2 AC FRACTIONAL MANUAL STARTERS

- A. The manual starter shall consist of a manually operated toggle switch equipped with melting alloy type thermal overload relay.
- B. Thermal unit shall be one piece construction and interchangeable. Starter shall be inoperative if thermal unit is removed.

2.3 AC MANUAL STARTERS--LINE VOLTAGE TYPE

- A. Manual starters shall be constructed and tested in accordance with the latest published NEMA standards.
- B. The manual starters shall consist of a manually operated switch equipped with melting alloy type thermal overload relays in every phase conductor. Thermal units shall be one piece construction and the starter shall be inoperative if any thermal unit is removed.
- C. Starters shall be furnished in a NEMA 1 general purpose enclosure unless otherwise indicated on the plans or required by the conditions of the area in which they are installed.

2.4 AC MAGNETIC STARTERS--LINE VOLTAGE TYPE

- A. Motor starters shall be across-the-line magnetic type rated in accordance with NEMA standards, sizes and horsepower ratings.
- B. Starters shall be mounted in NEMA 1 general purpose enclosures unless otherwise indicated on plans or required by the conditions of the area in which they are installed.
- C. Starters shall be furnished with overload relays in every phase conductor and starters shall be inoperative if any overload unit is removed.
 - 1. Overload relays shall be bimetallic type. Thermal units shall be of one-piece construction and interchangeable.
- D. Starters through NEMA size five (5) shall be equipped with double break silver alloy contacts. Contacts shall be replaceable without removing power wiring or removing starter from panel.

SECTION 262900 – LOW VOLTAGE CONTROLLERS

- E. Coils shall be of molded construction and shall be 120 VAC. Starters shall have a fused 120V control power transformer in enclosure, or alternatively on 120/208 or 120/240 volt systems, the power system neutral conductor may be utilized. In all cases, control power shall be disconnected by the starter disconnecting means, unless otherwise specifically approved.
- F. Starters shall be suitable for field addition of at least four (4) auxiliary electrical interlocks of any arrangement, normally open or normally closed.
- G. Starters shall have enclosure mounted red running pilot light and Hand-Off-Auto switch.

2.5 AC COMBINATION STARTERS WITH FUSIBLE DISCONNECT SWITCH OR CIRCUIT BREAKER

- A. Combination starters shall be manufactured in accordance with the latest published NEMA standards, sizes and horsepower ratings.
- B. Disconnect switch combination starters shall consist of a visible blade disconnect switch and a motor starter.
- C. Combination starters shall be mounted in NEMA 1 general purpose enclosures unless otherwise indicated on the plans or required by the conditions of the area in which they are installed.
- D. The disconnect handle used on combination starters shall always be in control of the disconnect device with the door opened or closed. The disconnect handle shall be clearly marked as to whether the disconnect device is "on" or "off".
- E. Magnetic starters provided under all Divisions of the Specifications shall be in accordance with this Section.

PART 3 - EXECUTION

3.1 COORDINATION

- A. Coordinate details pertaining to the motor control equipment with the Division of these specifications where the equipment is specified.

3.2 CONTROL WIRING

- A. Control wiring and control devices shall be provided under the Specification Division in which the controlled equipment is specified. Coordinate all related work.

3.3 CONNECTIONS

- A. Provide liquid tight flexible conduit connections to motors and other equipment subject to vibration where LFMC is an acceptable wiring method. Provide flexible conduit connections to

SECTION 262900 – LOW VOLTAGE CONTROLLERS

motors and other equipment subject to vibration that is located in spaces used for environmental air (e.g. fan rooms). Minimum length 12 inches.

3.4 NAMEPLATES

- A. Provide engraved nameplates for all starters in accordance with Section 260553 – Identification for Electrical Systems. Coordinate names with mechanical equipment lists.

3.5 REDUCED VOLTAGE STARTERS

- A. Reduced voltage starters shall be provided for all motors larger than:

208 volts	25 horsepower
460 volts	50 horsepower

 - 1. This requirement shall apply to starters furnished in this Division and other Divisions of the specifications.
 - 2. Motors controlled by Variable Frequency Drives (VFDs) are not subject to this requirement.

3.6 TWO SPEED STARTERS

- A. Provide two speed starters for all two speed motors. Starters shall comply with the requirements of the equipment and motor manufacturers. Refer to Mechanical Equipment Lists for equipment with two speed motors.
- B. This requirement shall apply to starters furnished in this Division and other Divisions of the specifications.

3.7 FIELD QUALITY CONTROL

- A. Document each installation and operational step in accordance with approved shop drawings and manufacturer's requirements.

END OF SECTION 262900

SECTION 265000 – LIGHTING FIXTURES

PART 1 - GENERAL

1.1 DESCRIPTION

- A. This section describes general requirements, products and methods of execution relating to lighting fixtures, LEDs, LED drivers and related products approved for use on this project.
- B. The Fixture Schedule is a general guide to type, quality and other characteristics. Fixtures of equal or better performance and quality may be substituted, subject to approval.

1.2 RELATED SECTIONS

- A. 260529 – Hangers and Supports for Electrical Systems
- B. 260533 – Raceway and Boxes for Electrical Systems
- C. 262726 - Wiring Devices

1.3 QUALITY ASSURANCE

- A. The lighting fixtures shall be a standard catalog item as described on the Drawings and as made by a nationally recognized manufacturer.

1.4 SUBMITTALS

- A. Provide submittals for all products in accordance with Section 260000 and Division 1.
- B. Fixture mounting shall be clearly identified on submittal information and coordinated with architectural, features, assemblies, details and reflected ceiling plan.
- C. Color selection for fixtures and fixture accessories shall be clearly identified on submittal information and coordinated with architectural.

1.5 SHOP DRAWINGS

- A. Provide fabrication drawings that indicate fixture, type, kind, weight, LEDs, LED drivers, method of fitting and fastening parts together, location and complete details of method of suspension and fastening fixtures in place. Verify fixture dimensions with construction conditions prior to ordering fixtures.
- B. Provide wiring diagrams that indicate supply power and interconnections for lighting controls, equipment, and light fixtures. Provide sufficient information to assemble and install equipment at the project site without further instructions.

SECTION 265000 – LIGHTING FIXTURES

1.6 WARRANTY

- A. Special Warranties: Manufacturer's standard form in which manufacturer agrees to repair or replace components that fail in materials or workmanship within 60 months from date of Substantial Completion.

PART 2 - PRODUCTS

2.1 GENERAL

- A. Provide fixtures in conformance with the Fixture Schedule, with all suspension, supports, flanges, trim, mounting, and operating accessories normally considered necessary for a complete, functional, and safe installation, whether specifically called for in the Contract Documents or not.
- B. Linear fixture systems shall be provided with all corners, transitions, adjustable sections, custom angles, etc., to provide continuous linear systems.

2.2 LIGHT EMITTING DIODE (LED) FIXTURES

- A. LED fixtures shall comply with Illuminating Engineering Society (IES) LM-79 guidelines and shall have a LM-79 photometric test report. Fixture shall utilize components (i.e. LEDs, driver, fixture housing, etc) included in LM-79 test.
- B. LEDs shall comply with Illuminating Engineering Society (IES) LM-80 guidelines.
- C. Fixture shall have lumen maintenance testing with minimum test duration of 10,000 hours.
- D. Manufacturer stated end of life shall be at 70% light output. Operating life shall be no less than 50,000 hours.
- E. Color temperature, and color rendering index (CRI) shall conform to the lighting fixture schedule shown on the Drawings.
- F. Fixture components shall be lead free, mercury free and RoHS compliant.

2.3 FULLY RECESSED FIXTURES

- A. Fixtures shall have thermal protection conforming to the NEC and shall be so identified.
- B. Fixtures in direct contact with insulation shall be Type IC rated.

2.4 LED DRIVERS

- A. Characteristics:
 - 1. Input: 120-277V (UL) AC, 50-60Hz

SECTION 265000 – LIGHTING FIXTURES

2. Efficiency: >81% at full load
3. Power Factor: >0.9 at full load
4. Total Harmonic Distortion (THD): <20% at full load
5. 0-10V compatibility
6. Flicker-free dimming down to 1%

2.5 BATTERY POWERED EMERGENCY LIGHTING DRIVER – LED

- A. Provide emergency battery driver for LED fixtures with the following features:
 1. Shall be capable of operating at the minimum lumen output specified on the Lighting Fixture Schedule for a minimum of 90 minutes
 2. Universal input (120-277 VAC)
 3. Compatible with the LED fixture and driver intended for use with.
 4. High-temperature long-life, nickel-cadmium battery or as approved. Electronic charger with 24 hour or less recharge time.
 5. Charge indicator lamp and test switch, with lamp visible, and test switch accessible, without opening fixture.
 6. UL listed.
 7. When used with dimmable drivers/fixtures circuitry/programming to restore light output to specified lumens in emergency mode shall be provided.

2.6 FIXTURE ACCESSORIES

- A. Canopies for pendant hung fixtures shall be of the ball joint type. Where more than one pendant is used per fixture, a ball joint fitting shall also be provided in the fixture end of each pendant.

PART 3 - EXECUTION

3.1 GENERAL

- A. Drivers shall be installed per manufacturer's recommendations.
- B. Fixtures with integral drivers shall have the driver installed and prewired at the factory.
- C. Internal fixture wiring shall be factory installed in multiple fixtures which share a common driver. All wiring harnesses shall include an integral copper grounding conductor.

3.2 INSTALLATION

- A. Install fixtures level, plumb and true. Align rows accurately in three dimensions.
- B. Support suspended acoustical ceiling fixtures according to the requirements of the IBC and Section 260529 – Hangers and Supports as well as any local amendments.

SECTION 265000 – LIGHTING FIXTURES

- C. Fixture pendants, canopies, blank sections, corners, tees and other such accessories shall be finished to match their respective fixture.
- D. Refer to applicable details on architectural drawings for specific mounting requirements for all fixtures with special mounting requirements such as cove-mounted fixtures and linear fixtures.
- E. For linear fixture systems, verify fixture dimensions and mounting type with other trades prior to installation.
- F. Utility Rooms: Surface ceiling mount fixtures in rooms/areas with ceilings. In areas without ceilings pendant fixtures down to bottom of structure or height indicated on the Lighting Fixture Schedule. In areas with mechanical equipment, ductwork and piping, pendant fixtures down to bottom of mechanical ductwork or piping as appropriate. Fixture pendants shall be rigid (threaded hangar rods) and shall be sway braced where pendants exceed 24 inches in length.
- G. Provide an unswitched circuit connection for the following (as applicable):
 - 1. Exit signs
 - 2. Emergency lighting units (ELUs)
 - 3. Emergency fixtures
 - 4. Emergency night lights
 - 5. Fixtures with emergency battery LED drivers
- H. Wiring for fixtures connected to emergency circuits shall be kept entirely independent of all other wiring and equipment in accordance with NEC Article 700.
- I. Clean all fixtures and lenses prior to substantial completion and owner occupancy.

3.3 FIRE-RESISTIVE CONSTRUCTION

- A. Refer to Section 260000 Electrical General Requirements.

3.4 FIELD QUALITY CONTROL

- A. Document each installation and operational step in accordance with approved shop drawings and manufacturer's requirements.

END OF SECTION 265000

SECTION 270536 – CABLE TRAYS FOR TELECOMMUNICATIONS SYSTEMS

PART 1 - GENERAL

1.1 SUMMARY

- A. Provide a complete cable pathway support system as shown and specified including required connectors, supports, brackets, engineered seismic bracing, vertical and/or horizontal offsets, grounding, and hardware for a complete system.
- B. Related Sections
 - 1. 260526 - Grounding and Bonding for Electrical Systems
 - 2. 260529 - Hangers and Supports for Electrical Systems
 - 3. 272010 - Telecom Distribution System

1.2 REFERENCES

- A. Underwriters' Laboratories, Inc.
- B. National Electrical Code.
- C. Canadian Standards Association.
- D. ANSI/EIA/TIA-569 - Commercial Building Standard for Telecommunications Pathways and Spaces.
- E. ASTM A 123 - Zinc (Hot Dip Galvanized Coatings on Iron and Steel Products).
- F. ASTM A 510 - General Requirements for Wire Rods and Coarse Round Wire, Carbon Steel.
- G. ASTM B 633 - Electrodeposited Coatings of Zinc on Iron and Steel.
- H. ISO 9002.

1.3 SUBMITTALS Provide submittals for products in accordance with Section 260000 - Electrical General Requirements and Division 1.

1.4 SHOP DRAWINGS

- A. Work shall be laid out in advance. Shop Drawings shall be submitted to the Contracting Agency for approval before work begins.
- B. Work under this section has been indicated on the Drawings in locations which should allow installation without interfering with the work of other trades; however, exact finish locations cannot be indicated. Therefore, locations of work and equipment shall be verified to avoid

SECTION 270536 – CABLE TRAYS FOR TELECOMMUNICATIONS SYSTEMS

interferences, preserve head room and keep openings and passageways clear. Review the plans for the work of all trades and coordinate adjustment of the work of the trades to achieve the best installation for the Owner without additional claims or charges. Shop Drawings shall reflect coordination of work under this Section.

- C. Submit a complete pathway layout drawn at 1/8-inch = 1 foot scale minimum including suspension points, offsets, fire-wall penetrations and other essential information. Layout shall be coordinated with mechanical ventilation, plumbing, and fire suppression contractors to ensure that the required access is unobstructed for its entire length. Locations shall be dimensioned with all obstructions shown and noted. Drawings shall include sections of corridors and of areas where obstructions require special coordination, showing the location in relation to work of other trades. Submit layout for approval.

1.5 QUALITY ASSURANCE

- A. Products shall be of the latest approved design as manufactured by a nationally recognized manufacturer and shall be listed by the Underwriters' Laboratory and bear the UL label.
- B. Alternative systems to the Basis of Design will be considered providing that sufficient documentation is provided to satisfy the Contracting Agency that the equipment meets the requirements of the specification.

PART 2 - PRODUCTS

2.1 VENTILLATED LADDER TYPE CABLE TRAY

- A. Cable trays shall be of ventilated ladder type construction with widths and depths as indicated on the Drawings or as specified herein. The ladder tray shall be center supported or wall mounted, single or multiple tiered, as specified or shown on the Drawings.
- B. The tray shall be constructed of 6063-T6 aluminum alloy and shall utilize a spine 1.5 inch wide by 2.75 inch high. Rungs shall be rectangular in cross section, a minimum of 0.50 inches thick, have an internal center reinforcement member.
- C. Material: Trays and fittings shall be designed to support 75 pounds per linear foot, minimum, when supported on 12 foot centers.
- D. Edges of trays, rungs, and fittings shall be rounded and smooth.
- E. Ventilating ladder-type cable trays shall be open and shall not be equipped with side rails.
- F. Basis of Design: Mono-Systems, Inc. PowerTray or as approved.

SECTION 270536 – CABLE TRAYS FOR TELECOMMUNICATIONS SYSTEMS

2.2 FITTINGS

- A. Fittings, inserts, covers, couplings, connectors and other accessories required to for a complete rigid mechanical installation shall be of compatible material.
- B. Cable tray section connectors:
 - 1. Sections of cable tray shall be joined using a two-bolt rectangular splice connector which telescopes into tray spine. Splice connectors shall allow for thermal expansion/contraction of the tray system.
- C. Cable Tray Elbows and Fittings:
 - 1. Provide pre-manufactured elbows and fittings to accomplish changes of direction in cable tray runs, including but not limited to: 30, 45, and 90 degree horizontal elbows, horizontal tees, horizontal crossings, wyes, vertical crossings, wyes and elbows, and inside and outside vertical risers. Fittings shall be of the appropriate type and manufacture for each cable tray type. Minimum inside bending radius (effective cable path) at cable tray elbows and fittings shall be 12 inches.
- D. Cable Tray to Box Connector:
 - 1. Provide premanufactured tray to box connector for attachment of cable tray to wall at through wall penetrations (both sides) and for attachment to enclosures. Connectors shall have opening dimensions to match cross sectional area of cable tray, with metal flange on four sides, for attachment to surface of wall or enclosure. Tray shall attach to connector flange via two-bolt rectangular tray section connector which telescopes into tray spine.

2.3 J-HOOKS

- A. Where specifically permitted on the Drawings, cables from individual outlets may be run from the conduit stub-out to the cable tray system using j-hooks.
- B. Size J-hooks for 25 % spare capacity.
- C. No bridle rings are permitted.
- D. Equipment: Erico/Caddy CableCat, Panduit J-Mod, or as approved.

2.4 ACCESSORIES

- A. Dropouts: Provide solid-bottomed cable access dropouts with adequate bend radius where bundles of cables exit the bottom of horizontal cable tray sections.
- B. Grounding and Bonding Strap: Unless otherwise noted on the Drawings, provide braided ground strap to connect discontinuous sections of cable tray, e.g., at through-wall penetrations with tray terminated on each side of wall.

SECTION 270536 – CABLE TRAYS FOR TELECOMMUNICATIONS SYSTEMS

2.5 CABLE TRAY SUPPORTS

- A. Center supported cable trays with hangers 12 inches or less in length, measured from the top of the cable tray to the bottom of the structural support shall be supported on maximum 12 foot centers by 1/2 inch threaded rods. Support rods shall pass through a vertical hole in the splice connector or central spine. Each tray support shall be attached by one 1/2 inch nut washer and lock washer on the top and bottom of the spine. Additional supports shall be provided at bends and tee fittings. Factory provided J-hangers, Listed for use with the tray and installed in accordance with manufacturer's instructions may be provided in lieu of through-spine rod hangers.
- B. Center supported cable trays with hangers greater than 12 inches in length, measured from the top of the cable tray to the bottom of the structural support shall be provided with additional bracing as follows:
 - 1. Each support shall be equipped with manufacturer's recommended hanger rod stiffener system.
 - 2. Transverse seismic braces shall be provided at least every 10 feet-0 inches.
 - 3. Longitudinal seismic braces shall be provided at least every 20 feet-0 inches.
 - 4. Seismic supports shall be sized to accommodate the tray being fully loaded with cables.
- C. Seismic supports and bracing shall be in accordance with Section 260529 - Hangers and Supports for Electrical Systems and Seismic Control and the manufacturer's engineered solution for the project's seismic zone. Where required or recommended by the tray manufacturer, the Contractor shall employ the services of a licensed Structural or Seismic Engineer to design the seismic bracing for the specific seismic zone requirements.
- D. Wall Spacers: Factory provided wall spacers shall be provided between wall mounted cable tray spine and mounting surface to maintain space for rung ends extending through spine. Provide supports at intervals in accordance with manufacturer's requirements.

2.6 FIRE RATED ASSEMBLY PENETRATIONS

- A. Provide permanent fire stop system at all through penetrations of fire rated wall, floor and roof assemblies which meet the evaluation criteria set forth in ASTM Standard E-814 and UL Standard 1479 for fire tests of through penetrations.
- B. Fire stop materials, assemblies and installations shall be approved by Factory Mutual and shall be as published in the latest edition of the Underwriters Laboratories Fire Resistive Directory. Firestop Systems provided shall be acceptable to the Authority Having Jurisdiction.
- C. Penetration seal methods and materials shall have an Underwriters Laboratories fire rating equal to the wall or floor in which the openings are located. The penetration seal must allow future changes, such as addition or removal of cables, with no damage to the integrity of the seal. If the wall or floor penetration is for cable tray passage, the fire stop material shall have been tested by Underwriters Laboratories for use with aluminum cable tray. The penetration seal shall be unaffected by atmospheric conditions, water exposure, or constant high humidity. The

SECTION 270536 – CABLE TRAYS FOR TELECOMMUNICATIONS SYSTEMS

fire seal shall be installed strictly according to the manufacturer/distributor published instruction.

- D. Submit Shop Drawings showing detailed construction of the through penetration firestop system, with reference to the UL Fire Resistance Directory System Number.
- E. Unless otherwise submitted by the Contractor and approved by the Contracting Agency, through wall penetration assemblies shall consist of metallic sleeves inserted into the wall opening with a built-in fire sealing system sufficient to maintain the hourly fire rating of the barrier being penetrated. The self-contained sealing system shall automatically adjust to the installed cable loading and shall permit cables to be installed, removed, or retrofitted without the need to remove or re-install fire-stop materials.
- F. Provide number of pathway devices to accommodate all cables with an additional 15% spare capacity in each device. Provide one entirely spare pathway device, unless otherwise noted.
- G. Unless otherwise noted on the Drawings or allowed by the Specifications, ventilated ladder type cable trays shall not penetrate fire rated floor assemblies.
- H. Equipment: STI EZ Path Fire Rated Pathway, or as approved.

PART 3 - EXECUTION

3.1 INSTALLATION

- A. Proceed with the installation only after Shop Drawings are approved by the Contracting Agency. If the Contractor proceeds without approval, relocation as directed by the Contracting Agency shall be at the Contractor's expense.
- B. Install pathways level, straight and true to building lines, unless otherwise noted on Drawings or required due to structural considerations or obstructions.
- C. Cable tray clearances:
 - 1. Maintain 12 inches minimum clearance above top of cable tray. Maintain 3 inches minimum clearance between top surface of ceiling tiles and lowest point on cable tray or cable tray support assembly. Maintain 6 inches minimum clearance to all sides of tray unless tray is placed at a height which requires greater clearance for workers to gain safe, convenient access to tray. Coordinate layout with work of other trades in advance of installation to provide required access with minimum number of offsets in cable tray runs.
- D. If during construction as-built conditions occur, such that cable tray becomes inaccessible for any reason, submit immediately to the Contracting Agency:
 - 1. The type and location of the obstruction, including the trades involved.
 - 2. The means proposed to maintain accessibility.

SECTION 270536 – CABLE TRAYS FOR TELECOMMUNICATIONS SYSTEMS

- E. Install cable tray in an accessible location, visible from the floor, with minimum length hanger rods to avoid cable tray tilting under eccentric loads. If tray tilts at any location, provide 1-1/2 inch pipe in compression over hanger rods, a bar stiffener at hanger rods, or other manufacturer recommended anti-tilt method of mounting tray. Provide stiffener bar at every other support, or in accordance with manufacturer's recommendations.
- F. Install and support cable tray systems in accordance with span load criteria, assuming 110% of maximum allowable cable-fill regardless of the number of cables installed under this Contract.
- G. Install cable tray to prevent sharp 90 degree bends in cables in any direction. Rises and drops shall be radiused, tees and crosses shall be flared or have radius fittings at junction points.
- H. Seismic supports and bracing shall be in accordance with Section 260529 - Hangers and Supports for Electrical Systems and the manufacturer's engineered solution for the project's seismic zone.
- I. Center hung supports and center support tubes shall run full length of the rod to the structure. Tighten rod to place assembly in tension. Center supports suspended by rods shall have sufficient protective tubing over exposed all thread to protect the cable insulation from abrasion.
- J. Cable tray arranged in vertical configuration for rises and drops shall have standoff support from the wall or structural support surface the facilitate installation of cable support ties. Secure cables in trays with cable ties in accordance with the manufacturer's recommendations.
- K. Unless otherwise noted on the Drawings or allowed in the Specifications, above ceiling cable tray installations shall meet the following conditions:
 - 1. Cable trays shall not be installed in inaccessible ceiling areas such as those with lock-in type ceiling tiles.
 - 2. Cable trays shall not be installed above lay-in type ceilings at a finished height greater than 11 feet above finished floor.
- L. Unless otherwise noted on the Drawings, install cable tray and accessories to provide electrical continuity throughout system. Provide grounding and bonding straps to maintain electrical continuity at discontinuous connections.
- M. Follow manufacturer's instructions and details for separation of dissimilar metals including steel suspension rod to aluminum splice connectors or cable tray. Provide nylon bushings at joints, vinyl sleeve at hanger rods.
- N. Conduit Entries:
 - 1. Open Cable Tray: Conduits entering open cable trays shall terminate above the tray, within 3 inches laterally and 2 inches vertically of the top of the side rail. Conduits shall be bushed and supported within 6 inches of the termination. Provide a bonding connection from the conduit to the tray system.
 - 2. Enclosed Cable Tray: Conduits entering enclosed industrial cable tray shall be connected to the tray at the vertical center line of either side with an approved conduit connector.

SECTION 270536 – CABLE TRAYS FOR TELECOMMUNICATIONS SYSTEMS

Conduit connectors shall be bushed inside the cable tray. Conduits shall be installed and supported in accordance with the NEC and Section 26 0533 – Raceways and Boxes for Electrical Systems. Conduits shall be installed so as to allow free removal of all sections of the cable tray top cover. Provide a grounding connection from the conduit to the cable tray system.

- O. Coordinate installation of cable tray with cable installers for purposes of symmetric cable loading, supplemental bracing in cases where cable loading will be asymmetric, periodic tie down of cables, and division of tray to maintain required separation of systems.

3.2 FIELD QUALITY CONTROL

- A. Document each installation and operational step in accordance with approved shop drawings and manufacturer's requirements.

END OF SECTION 270536

SECTION 270536 – CABLE TRAYS FOR TELECOMMUNICATIONS SYSTEMS

THIS PAGE INTENTIONALLY LEFT BLANK

APPENDIX A

Siemens Definition Edge
Shielding Specifications and Details for
MRI and CT Scanners

April 4, 2022

List of Documents

No.	Document No.	Document
01	98495-1462799-01	Magnetic Shielding
02	98495-1462799-02	Overview
03	98495-1462799-03	Fringefields
04	98495-1462799-04	Fringefields
05	98495-1462799-05	Shield dimensions
06	98495-1462799-06	Examples for connections

© Siemens Healthcare GmbH created by Sales CAD

UNITS

Length m
Magn Flux Density T
Magnetic Field A/m
Magn Scalar Pot A
Current Density A/m²
Power W
Force N

MODEL DATA

or 124_JUNEAU_BRH_01.op3
Magnetostatic (TOSCA)
Nonlinear materials
Simulation No 1 of 1
307490 elements
638010 nodes
4 conductors
Nodally interpolated fields
Activated in global coordinates
Reflection in YZ plane (X field=0)

Field Point Local Coordinates

Local = Global

FIELD EVALUATIONS

Fit	FIT (Integral)	32x32	Spherical
	r=0.25	φ=0.00429792	ψ=0.0 to 6.283185
		to 3.137295	
Cartesian (nodal)	CARTESIAN	150x100	Cartesian
	x=0.0	y=-6.0 to 6.0	z=9.0 to -9.0

Magnetic Shielding

(Drawing #2100552 / Sales Order #0030257551)

Korb T. 08.04.2022		
Edited	Checked	Released

	<p>Siemens Healthcare GmbH Planning department Hartmannstrasse 16 D-91052 Erlangen</p>
--	--

Bartlett Regional Hospital
 3260 Hospital Dr
 Juneau, AK 99801-7808

**MAGNETIC RESONANCE
 MAGNETOM Sola**

Project 98495	File 1462799	Revision	Page 01 of 06	Size A4	Scale
------------------	-----------------	----------	------------------	------------	-------

Element	Weight [lbs]	Material	Page
Shielding Rearwall	1537	M36	5
Shielding Floorplate	439	M36	5
Total weight	1976		

Magnet put on Stop Choc's Sylomer X

B-field error
% rms
1.371354

Forces on coils [N]		
in X	in Y	in Z
0	-324	-627

OP3 filename: or124_JUNEAU_BRH_01.op3

Overview

		MAGNETIC RESONANCE MAGNETOM Sola	
Bartlett Regional Hospital 3260 Hospital Dr Juneau, AK 99801-7808			Size A4
Project 98495	File 1462799	Revision Page 02 of 06	Scale

or124_JUNEAU_BRH_01.op3

Fieldlines for:

- 0.05 mT
- 0.15 mT
- 0.5 mT
- 1 mT
- 3 mT
- 5 mT
- 10 mT
- 20 mT

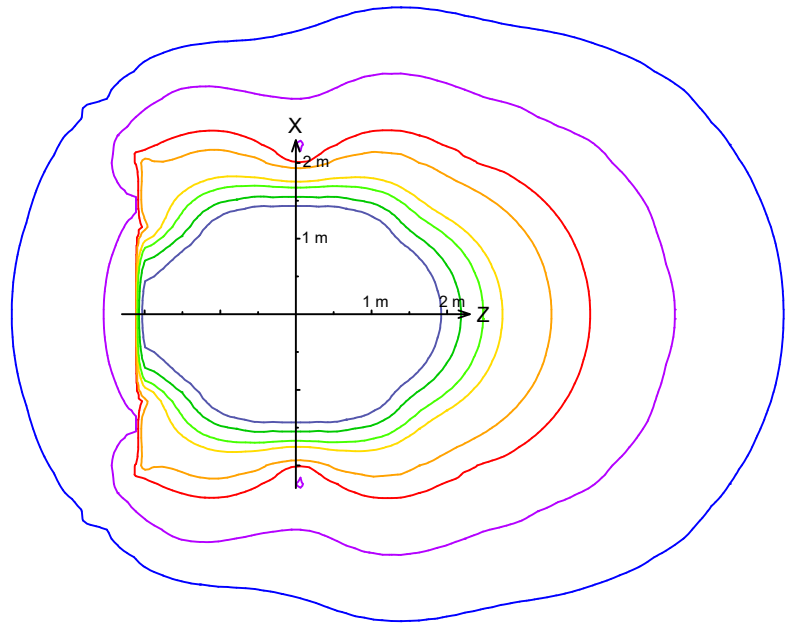

or124_JUNEAU_BRH_01.op3

Fieldlines for:

- 0.05 mT
- 0.15 mT
- 0.5 mT
- 1 mT
- 3 mT
- 5 mT
- 10 mT
- 20 mT

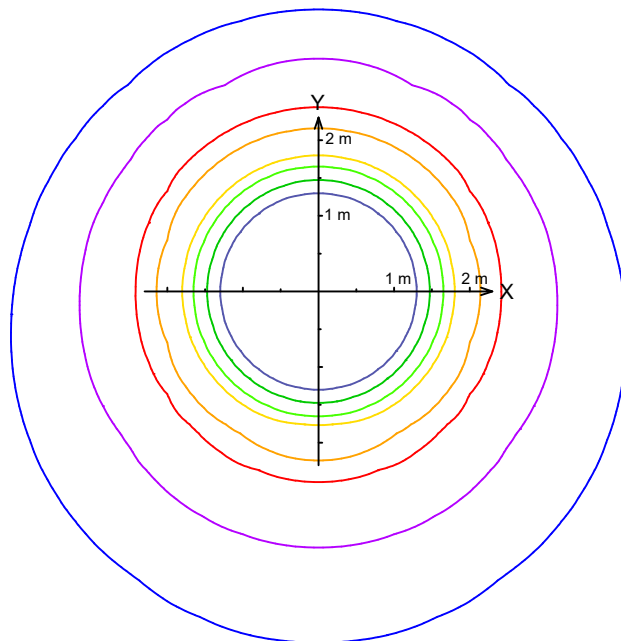

Fringefields



MAGNETIC RESONANCE
MAGNETOM Sola

Bartlett Regional Hospital

3260 Hospital Dr
Juneau, AK 99801-7808

Project
98495

File
1462799

Size
A4
Revision

Scale
1:100
Page
03 of 06

or124_JUNEAU_BRH_01.op3

Fieldlines for:

0.05 mT

0.15 mT

0.5 mT

1 mT

3 mT

5 mT

10 mT

20 mT

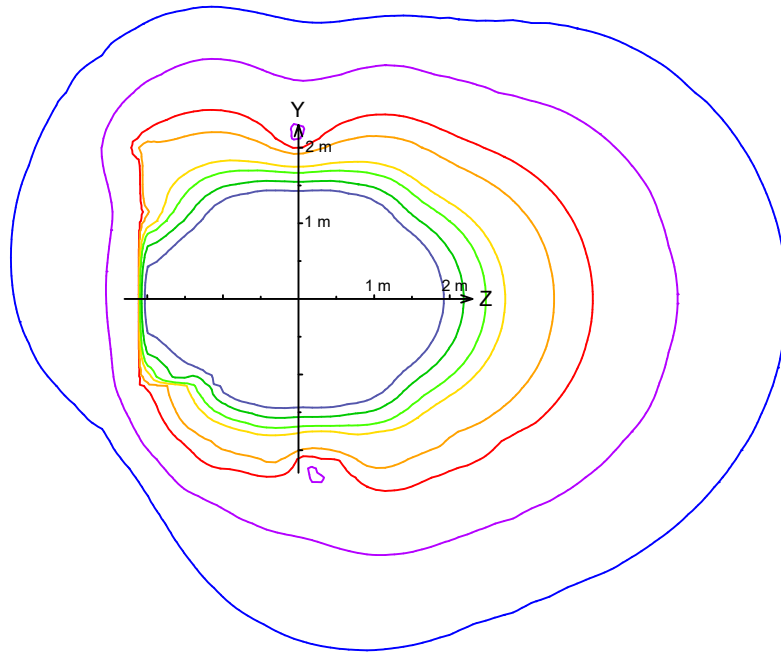

Fringefields



MAGNETIC RESONANCE
MAGNETOM Sola

Bartlett Regional Hospital

3260 Hospital Dr
Juneau, AK 99801-7808

Project
98495

File
1462799

Size

A4

Scale

1:100

Revision

Page

04 of 06

Shielding Rearwall		
Position in Z-Direction	-205 cm	-6'-8 3/4"
magnetic flux in direction	XY	
Shielding Material	M36	
Weight	697 kg	1537 lbs

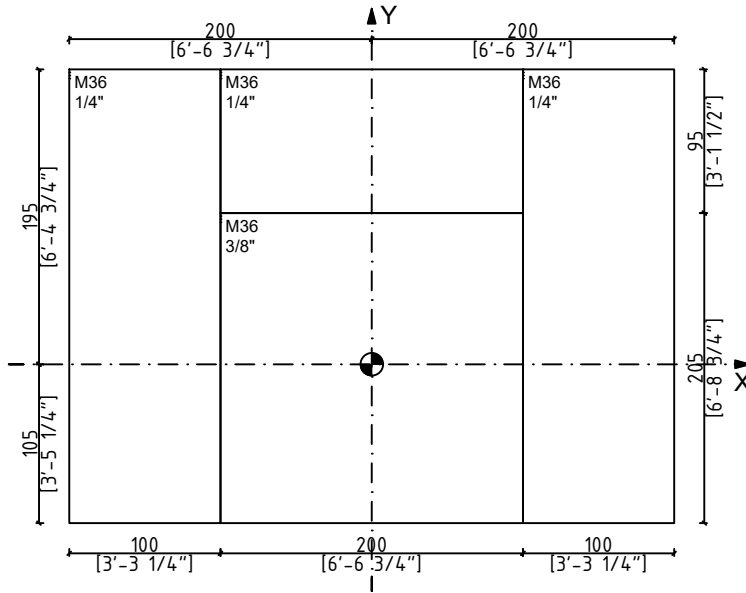

Shielding Floorplate		
Position in Y-Direction	-105 cm	-3'-5 3/8"
magnetic flux in direction	Z	
Shielding Material	M36	
Weight	199 kg	439 lbs

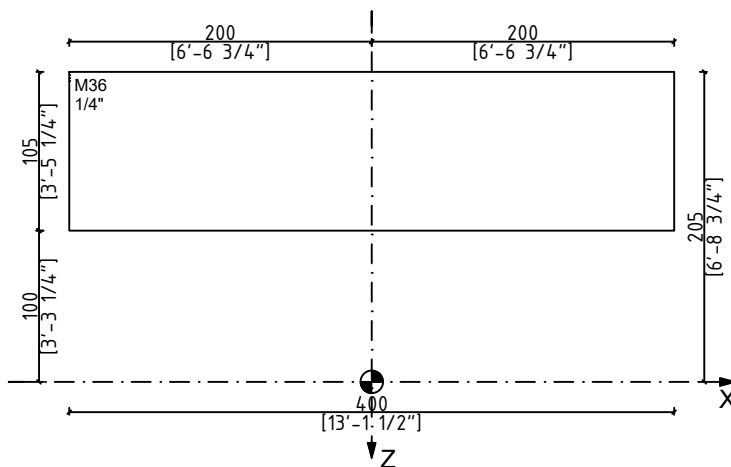

Shield dimensions

		MAGNETIC RESONANCE MAGNETOM Sola		
Bartlett Regional Hospital 3260 Hospital Dr Juneau, AK 99801-7808			Size A4	Scale 1:50
Project 98495	File 1462799	Revision Page 05 of 06		

Examples for connections with transformer sheets (not to scale)

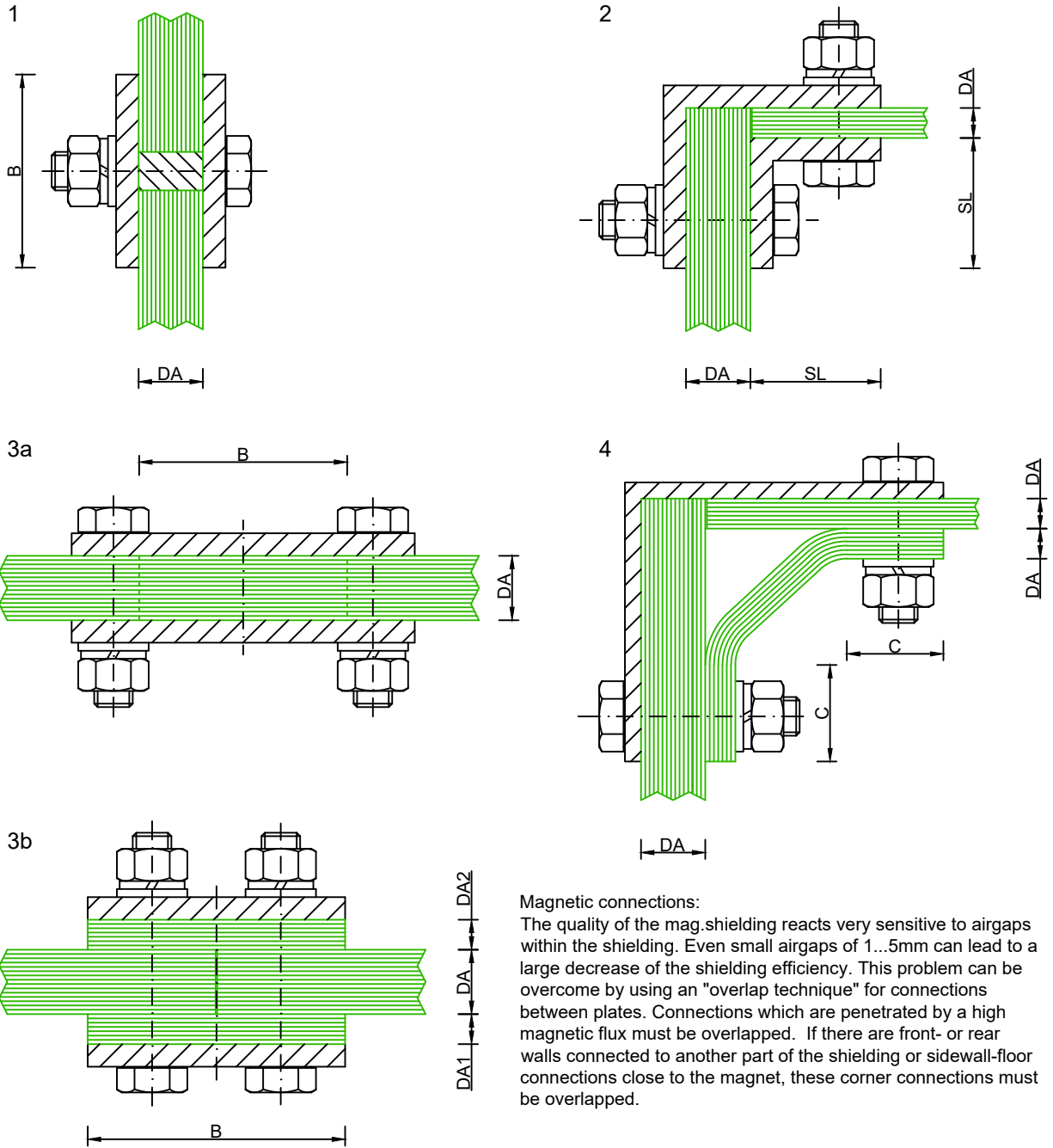

$$DA1 + DA2 = DA$$

$$B \geq 6 \times DA, \text{ min. } 60\text{mm}$$

$$C \geq 3 \times DA, \text{ min. } 30\text{mm}$$

$$SL = 3 \times DA, \text{ min. } 30\text{mm}$$

Ironplate / Filling material (mild steel)

Magnetic connections:

The quality of the mag.shielding reacts very sensitive to airgaps within the shielding. Even small airgaps of 1...5mm can lead to a large decrease of the shielding efficiency. This problem can be overcome by using an "overlap technique" for connections between plates. Connections which are penetrated by a high magnetic flux must be overlapped. If there are front- or rear walls connected to another part of the shielding or sidewall-floor connections close to the magnet, these corner connections must be overlapped.

Examples of different types of connections:

- "1" nonoverlapping conn. (transformer sheet metal)
- "2" nonoverlapping corner conn. (transformer sheet metal)
- "3a,b" overlapping conn. (transformer sheet metal)
- "4" overlapping corner conn. (transformer sheet metal)

Processing the material:

- transformer sheet metal : accepted is bolting.
- steel : accepted is bolting,welding
- welding seams inside of the shielding (not at the surface) may need to be abraded to avoid airgaps to the next layer of iron.

Examples for connections

		MAGNETIC RESONANCE MAGNETOM Sola	
Bartlett Regional Hospital 3260 Hospital Dr Juneau, AK 99801-7808			Size A4
Project 98495	File 1462799	Revision Page 06 of 06	Scale Page 06 of 06

Bartlett Regional Hospital

3260 Hospital Drive
Juneau, AK 99801

Radiation Shielding Design

Siemens Definition Edge
CT Room 1

November 22, 2021

Performed by

Eric Hooper, MS, CHP, DABSNM
Medical Physicist



SHIELDING DESIGN SUMMARY

Facility	Bartlett Regional Hospital	Report Date	November 22, 2021
Room	CT Room 1	X-Ray Registration #	N/A
Manufacturer	Siemens	UBI Number	N/A
Model	Definition Edge	Physicist	Eric Hooper, MS, CHP, DABSNM
Machine Type	CT	Imaging Type	N/A

A Siemens Somatom Definition AS+ will be installed at Bartlett Regional Hospital. This CT unit is a replacement of an existing CT unit. The evaluation summary and shielding calculations used to generate the shielding report are attached.

Barrier	Description	Required Shielding	Existing Shielding	Minimum Shielding To Be Installed
A	Control Room Wall and Window	0.74 mm Pb	3 lb Lead (1.19 mm)	None
B	Control Room Door	0.10 mm Pb	2 lb Lead (0.79 mm)	None
C	West Wall - Hallway	0.64 mm Pb	2 lb Lead (0.79 mm)	None
D	Exam Room Door	0.51 mm Pb	2 lb Lead (0.79 mm)	None
E	North Wall - Exam Room	1.35 mm Pb	4 lb Lead (1.58 mm)	None
F	East Wall - Underground	N/A	N/A	N/A
N/A	Floor	N/A	N/A	N/A
N/A	Ceiling	121.78 mm Concrete	304 mm Concrete	None

Comments

- The above table summarizes the minimum shielding that must be installed to meet the design goals specified in NCRP Report 147.
- Please review the *Methods & Assumptions* as well as the *Design & Building Requirements* to ensure adequate barrier installation.



Eric Hooper, MS, CHP, DABSNM

Medical Physicist

eric@olympichp.com

253-432-2806

METHODS & ASSUMPTIONS

- NCRP Report No. 147 was used as the primary reference for the shielding calculations. Appropriate fitting parameters were used to determine the required shielding. Fitting parameters for CT were taken for a 140 kVp beam for Lead and Concrete from Figures A.2 and A.3 in NCRP Report No. 147.
- The average Body DLP and average Head DLP was taken from Table 5.2, NCRP Report No. 147.
- The design goals was assumed to be 0.10 mGy/week for controlled areas and 0.02 mGy/week for
- Occupancy Factors were taken from Table 4.1, NCRP Report No. 147.
- Thest estimated workload is 100 diagnostic CT's per week. The diagnostic CT workload is estimated to be 70% Body CT and 30% Head CT. Total CT volume is expected to be 30 Head CT's per week and 70 Body CT's per week. It was assumed that 60% of all procedures are performed with contrast resulting in a 1.6 multiplier of the expected DLP.
- The space is located in a multi-story building. The CT Room is slab on grade. There is assumed to be fully occupied spaces above the CT Room.
- This room is a replacement of an existing CT scanner. The room was previously used for CT equipment. The building "as-builts" were provided and used to determine the existing shielding composition and thickness.

DESIGN & BUILDING REQUIREMENTS

- All walls requiring shielding must have the shielding extend from the floor to a height of at least 7 feet.
- Barrier penetrations, such as those for outlets, switches, light boxes, etc, should be wrapped or backed with equivalent shielding as specified for the prescribed wall.
- Any changes or alterations to the workload, occupancy, room design, or equipment may require the installation of additional shielding. Consultation with a medical physicist should be conducted in the event of future changes.
- **Control Room Wall and Window - Wall A** - The existing 1.19 mm Pb (3 pound lead) is adequate for this wall. Additionally, there should be a viewing window of at least 1 sq. ft. to allow viewing of the patient. The existing 1.19 mm Pb (3 pound lead) is adequate for this viewing window. No additional shielding is required.
- **Room Door - Door B** - The existing 0.79 mm Pb (2 pound lead) is adequate for this door. No additional shielding is required.
- **West Wall - Exterior - Wall C** - The existing 0.79 mm Pb (2 pound lead) is adequate for this wall. No additional shielding is required.
- **Exam Room Door - Door D** - The existing 0.79 mm Pb (2 pound lead) is adequate for this door. No additional shielding is required.
- **North Wall - Exam Room - Wall E** - The existing 1.58 mm Pb (4 pound lead) is adequate for this wall. No additional shielding is required.
- **East Wall - Underground - Wall F** - As this wall is an underground, exterior wall, no shielding is required.
- **Floor** - The CT Room is slab on grade. No additional shielding is required.
- **Ceiling** - This is a multi-story building with full occupancy above. The existing 304 mm concrete decking is adequate for this barrier. No additional shielding is required.

SHIELDING DESIGN CALCULATIONS

Computed Tomography Assumptions								
$K_{\text{body}} \text{ (cm}^{-1}\text{)}$	$K_{\text{head}} \text{ (cm}^{-1}\text{)}$	Head DLP (mGy cm)	Body DLP (mGy cm)	No. of Head Procedures per Week	No. of Body Procedures per Week	$K_{\text{sec}}^1 \text{ (head)}$ (mGy/proc)	$K_{\text{sec}}^1 \text{ (body)}$ (mGy/proc)	Total mGy/week @ 1 m
3.00E-04	9.00E-05	1200	550	30	70	0.17	0.32	27.36

*Calculations based on NCRP 147, Section 5.6.1 Dose-Length Product Method. Fitting parameters obtained from Fig. A.2 and Fig. A.3 at 140 kVp for CT.

Barrier	Description	Distance (meters)	Occupancy Factor (T)	Design Goal (mGy/wk)	Unshielded Weekly Air Kerma (mGy/wk)	Allowed Transmission (x barrier)	Required Shielding	Existing Shielding	Minimum Shielding To Be Installed
A	Control Room Wall and Window	3.38	1	0.1	2.39E+00	4.18E-02	0.74 mm Pb	3 lb Lead (1.19 mm)	None
B	Control Room Door	4.37	0.125	0.1	1.79E-01	5.58E-01	0.10 mm Pb	2 lb Lead (0.79 mm)	None
C	West Wall - Hallway	3.96	0.2	0.02	3.49E-01	5.73E-02	0.64 mm Pb	2 lb Lead (0.79 mm)	None
D	Exam Room Door	3.99	0.125	0.02	2.15E-01	9.31E-02	0.51 mm Pb	2 lb Lead (0.79 mm)	None
E	North Wall - Exam Room	2.13	0.5	0.02	3.02E+00	6.63E-03	1.35 mm Pb	4 lb Lead (1.58 mm)	None
F	East Wall - Underground	2.36	N/A	N/A	N/A	N/A	N/A	N/A	N/A
N/A	Floor	N/A	N/A	N/A	N/A	N/A	N/A	N/A	N/A
N/A	Ceiling	3.66	1	0.02	2.04E+00	9.79E-03	121.8 mm Concrete	304 mm Concrete	None

FLOOR PLAN

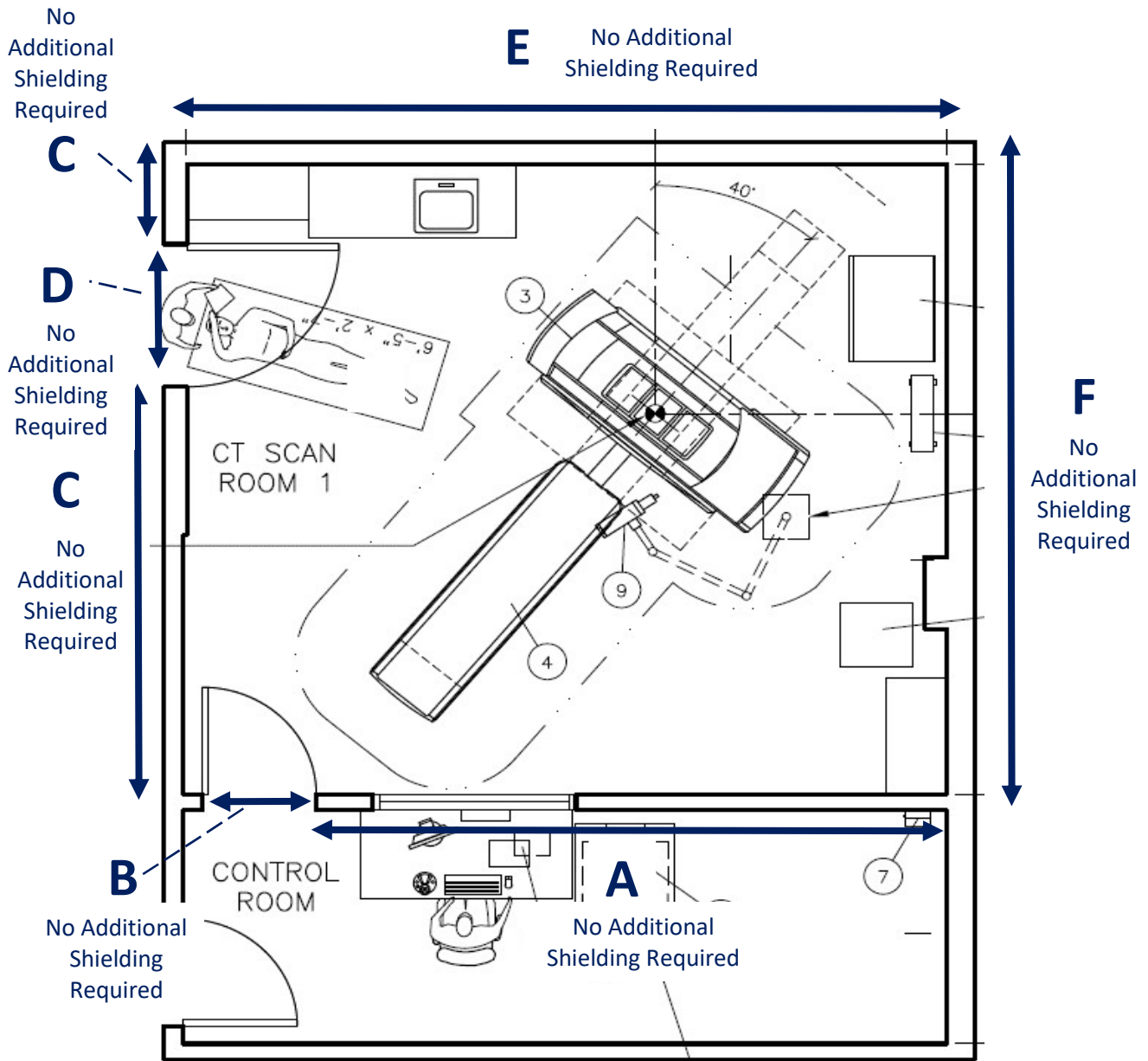

ISODOSE CURVES

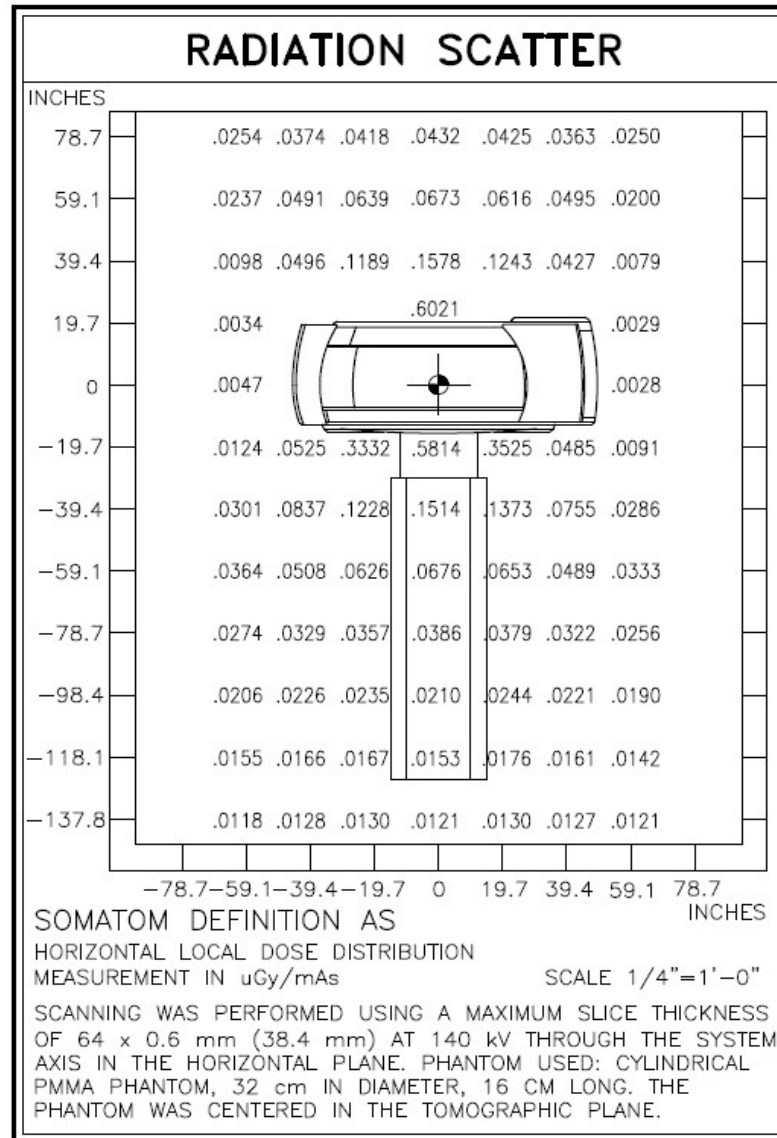

ISODOSE CURVES

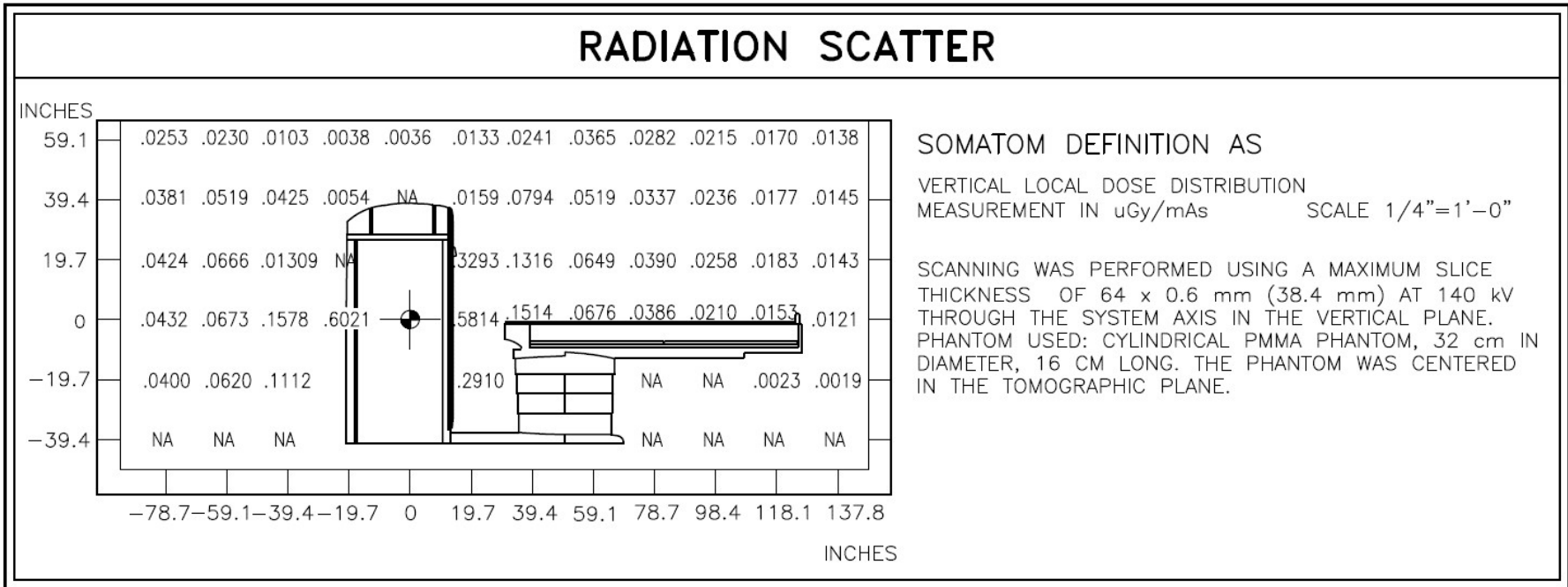

CT SCAN ROOM AS-BUILTS

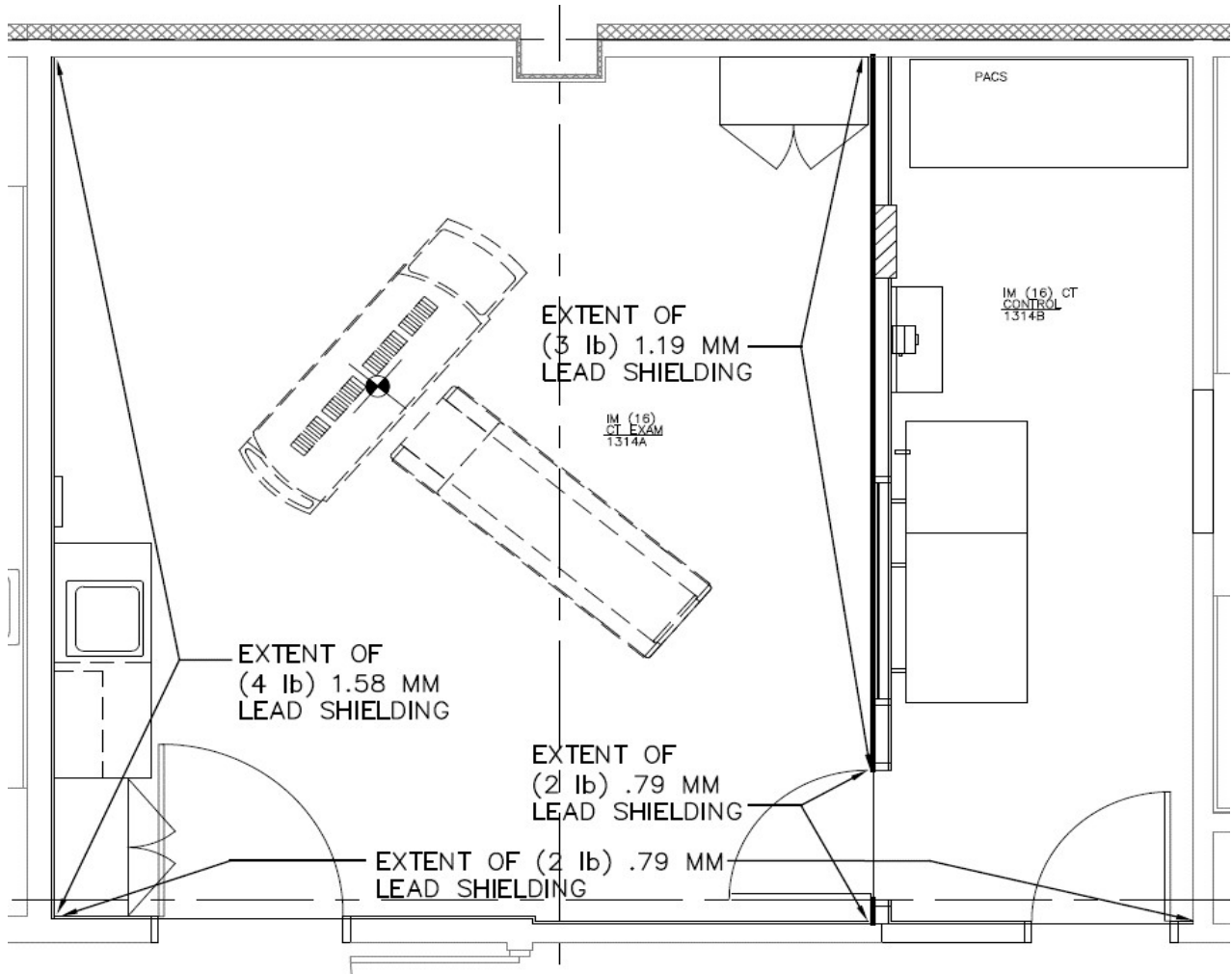

SCHEDULE OF COMMERCIAL LEAD THICKNESS & WEIGHT

Lead Sheet Thickness (Fractions of an Inch)	Decimal Equivalent	Millimeter Equivalent	Weight Nominal Pounds per Sq. Ft.
1/64"	0.0156"	0.04 mm	1 pound
1/32"	0.0312"	0.08 mm	2 pound
5/128"	0.0391"	0.10 mm	2.5 pound
3/64"	0.0469"	1.19 mm	3 pound
1/16"	0.0625"	1.59 mm	4 pound
5/64"	0.0781"	1.98 mm	5 pound
3/32"	0.0937"	2.38 mm	6 pound
1/8"	0.125"	3.18 mm	8 pound
5/32"	0.1562"	3.97 mm	10 pound
3/16"	0.1875"	4.76 mm	12 pound
1/4"	0.25"	6.35 mm	16 pound
3/8"	0.375"	9.53 mm	24 pound

Bartlett Regional Hospital

3260 Hospital Drive
Juneau, AK 99801

Radiation Shielding Design

Siemens Definition AS+ 128
CT Room 1361

June 30, 2022

Performed by

Eric Hooper, MS, CHP, DABSNM
Medical Physicist



SHIELDING DESIGN SUMMARY

Facility	Bartlett Regional Hospital	Report Date	June 30, 2022
Room	CT Room 1361	X-Ray Registration #	N/A
Manufacturer	Siemens	UBI Number	N/A
Model	Definition AS+ 128	Physicist	Eric Hooper, MS, CHP, DABSNM
Machine Type	CT	Imaging Type	N/A

A Siemens Somatom Definition AS+ 128 will be installed at Bartlett Regional Hospital. This CT unit is a replacement of an existing CT unit. The evaluation summary and shielding calculations used to generate the shielding report are attached.

Barrier	Description	Required Shielding	Existing Shielding	Minimum Shielding To Be Installed
A	South Wall - Exterior	0.30 mm Pb	10" CMU	None
B	West Wall - Equipment Room	0.13 mm Pb	3 lb Lead (1.19 mm)	None
C	Control Room Wall and Window	0.62 mm Pb	3 lb Lead (1.19 mm)	None
D	North Wall - Hallway	0.62 mm Pb	3 lb Lead (1.19 mm)	None
E	Room Door	0.49 mm Pb	3 lb Lead (1.19 mm)	None
F	East Wall - Patient Prep	0.95 mm Pb	4 lb Lead (1.58 mm)	N/A
G	East Wall - Bathroom	0.53 mm Pb	3 lb Lead (1.19 mm)	N/A
H	Bathroom Door	0.76 mm Pb	3 lb Lead (1.19 mm)	N/A
N/A	Floor	N/A	N/A	N/A
N/A	Ceiling	115.03 mm Concrete	304 mm Concrete	None

Comments

- The above table summarizes the minimum shielding that must be installed to meet the design goals specified in NCRP Report 147.
- Please review the *Methods & Assumptions* as well as the *Design & Building Requirements* to ensure adequate barrier installation.



Eric Hooper, MS, CHP, DABSNM

Medical Physicist

eric@olympichp.com

253-432-2806

METHODS & ASSUMPTIONS

- NCRP Report No. 147 was used as the primary reference for the shielding calculations. Appropriate fitting parameters were used to determine the required shielding. Fitting parameters for CT were taken for a 140 kVp beam for Lead and Concrete from Figures A.2 and A.3 in NCRP Report No. 147.
- The average Body DLP and average Head DLP was taken from Table 5.2, NCRP Report No. 147.
- The design goals was assumed to be 0.10 mGy/week for controlled areas and 0.02 mGy/week for
- Occupancy Factors were taken from Table 4.1, NCRP Report No. 147.
- Thest estimated workload is 81 diagnostic CT's per week. The diagnostic CT workload is estimated to be 55 Body CT's and 26 Head CT's. It was assumed that 50% of all procedures are performed with contrast resulting in a 1.5 multiplier of the expected DLP.
- The space is located in a multi-story building. The CT Room is slab on grade. There is assumed to be fully occupied spaces above the CT Room.
- This room is a replacement of an existing CT scanner. The room was previously used for CT equipment. The building "as-builts" were provided and used to determine the existing shielding composition and thickness.

DESIGN & BUILDING REQUIREMENTS

- All walls requiring shielding must have the shielding extend from the floor to a height of at least 7 feet.
- Barrier penetrations, such as those for outlets, switches, light boxes, etc, should be wrapped or backed with equivalent shielding as specified for the prescribed wall.
- Any changes or alterations to the workload, occupancy, room design, or equipment may require the installation of additional shielding. Consultation with a medical physicist should be conducted in the event of future changes.
- **South Wall - Exterior - Wall A** - As this wall is an exterior wall with 10" CMU, no shielding is required.
- **West Wall - Equipment Room - Wall B** - The existing 1.19 mm Pb (3 pound lead) is adequate for this wall. No additional shielding is required.
- **Control Room Wall and Window - Wall C** - The existing 1.19 mm Pb (3 pound lead) is adequate for this wall. Additionally, there should be a viewing window of at least 1 sq. ft. to allow viewing of the patient. The existing 1.19 mm Pb (3 pound lead) is adequate for this viewing window. No additional shielding is required.
- **North Wall - Hallway - Wall D** - The existing 1.19 mm Pb (3 pound lead) is adequate for this wall. No additional shielding is required.
- **Room Door - Door E** - The existing 1.19 mm Pb (3 pound lead) is adequate for this door. No additional shielding is required.
- **East Wall - Patient Prep - Wall F** - The existing 1.58 mm Pb (4 pound lead) is adequate for this wall. No additional shielding is required.
- **East Wall - Bathroom - Wall G** - The existing 1.19 mm Pb (3 pound lead) is adequate for this wall. No additional shielding is required.
- **Bathroom Door - Door H** - The existing 1.19 mm Pb (3 pound lead) is adequate for this door. No additional shielding is required.
- **Floor** - The CT Room is slab on grade. No additional shielding is required.
- **Ceiling** - This is a multi-story building with full occupancy above. The existing 304 mm concrete decking is adequate for this barrier. No additional shielding is required.

SHIELDING DESIGN CALCULATIONS

Computed Tomography Assumptions								
$K_{\text{body}} \text{ (cm}^{-1}\text{)}$	$K_{\text{head}} \text{ (cm}^{-1}\text{)}$	Head DLP (mGy cm)	Body DLP (mGy cm)	No. of Head Procedures per Week	No. of Body Procedures per Week	$K_{\text{sec}}^1 \text{ (head)}$ (mGy/proc)	$K_{\text{sec}}^1 \text{ (body)}$ (mGy/proc)	Total mGy/week @ 1 m
3.00E-04	9.00E-05	1200	550	26	55	0.16	0.32	21.64

*Calculations based on NCRP 147, Section 5.6.1 Dose-Length Product Method. Fitting parameters obtained from Fig. A.2 and Fig. A.3 at 140 kVp for CT.

Barrier	Description	Distance (meters)	Occupancy Factor (T)	Design Goal (mGy/wk)	Unshielded Weekly Air Kerma (mGy/wk)	Allowed Transmission (x barrier)	Required Shielding	Existing Shielding	Minimum Shielding To Be Installed
A	South Wall - Exterior	2.43	0.025	0.02	9.16E-02	2.18E-01	0.30 mm Pb	10" CMU	None
B	West Wall - Equipment Room	3.63	0.025	0.02	4.10E-02	4.87E-01	0.13 mm Pb	3 lb Lead (1.19 mm)	None
C	Control Room Wall and Window	3.65	1	0.1	1.62E+00	6.16E-02	0.62 mm Pb	3 lb Lead (1.19 mm)	None
D	North Wall - Hallway	3.68	0.2	0.02	3.20E-01	6.26E-02	0.62 mm Pb	3 lb Lead (1.19 mm)	None
E	Room Door	3.68	0.125	0.02	2.00E-01	1.00E-01	0.49 mm Pb	3 lb Lead (1.19 mm)	None
F	East Wall - Patient Prep	2.14	0.2	0.02	9.45E-01	2.12E-02	0.95 mm Pb	4 lb Lead (1.58 mm)	N/A
G	East Wall - Bathroom	2.16	0.05	0.02	2.32E-01	8.63E-02	0.53 mm Pb	3 lb Lead (1.19 mm)	N/A
H	Bathroom Door	2.28	0.125	0.02	5.20E-01	3.84E-02	0.76 mm Pb	3 lb Lead (1.19 mm)	N/A
N/A	Floor	N/A	N/A	N/A	N/A	N/A	N/A	N/A	N/A
N/A	Ceiling	3.66	1	0.02	1.62E+00	1.24E-02	115.0 mm Concrete	304 mm Concrete	None

FLOOR PLAN

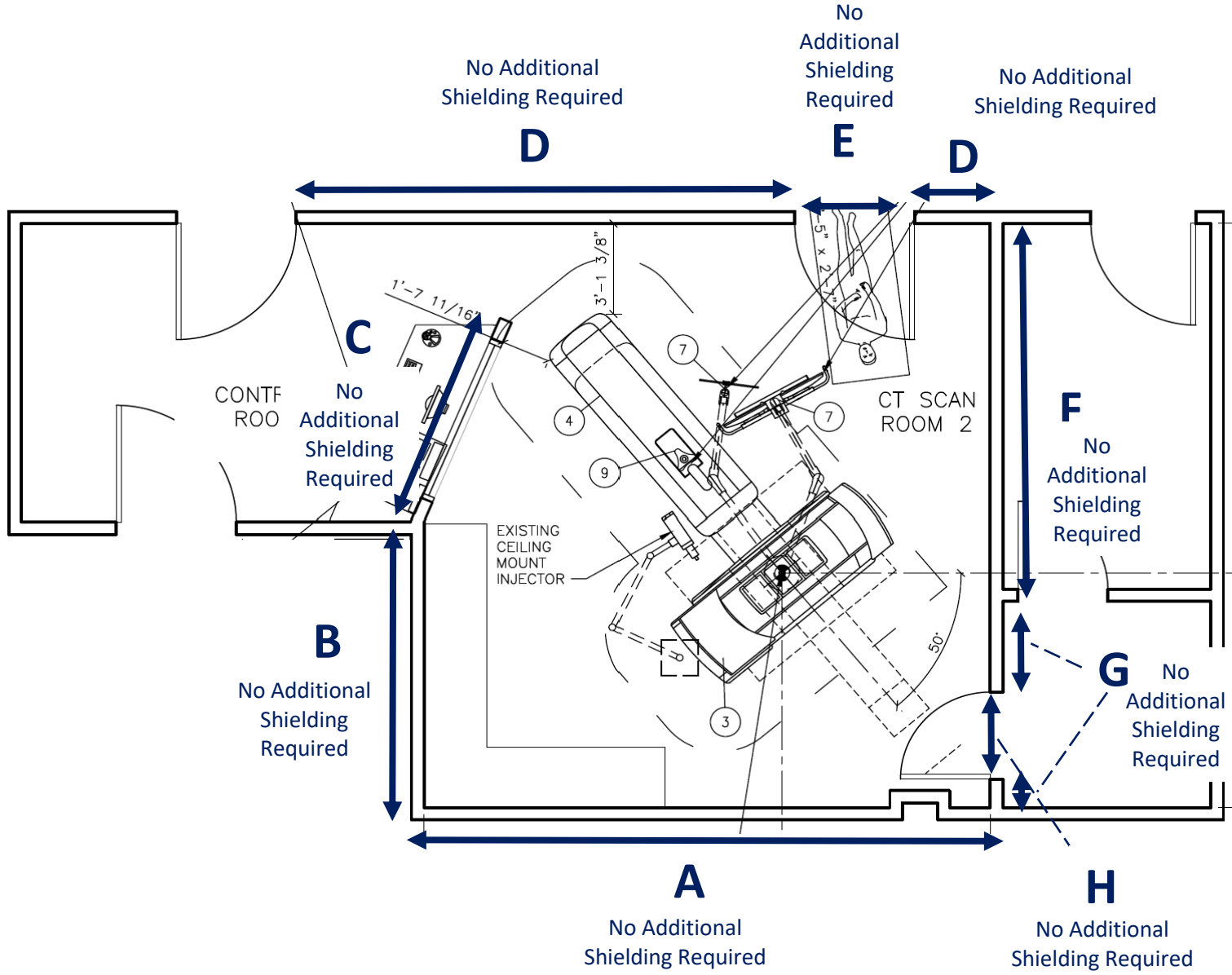

ISODOSE CURVES

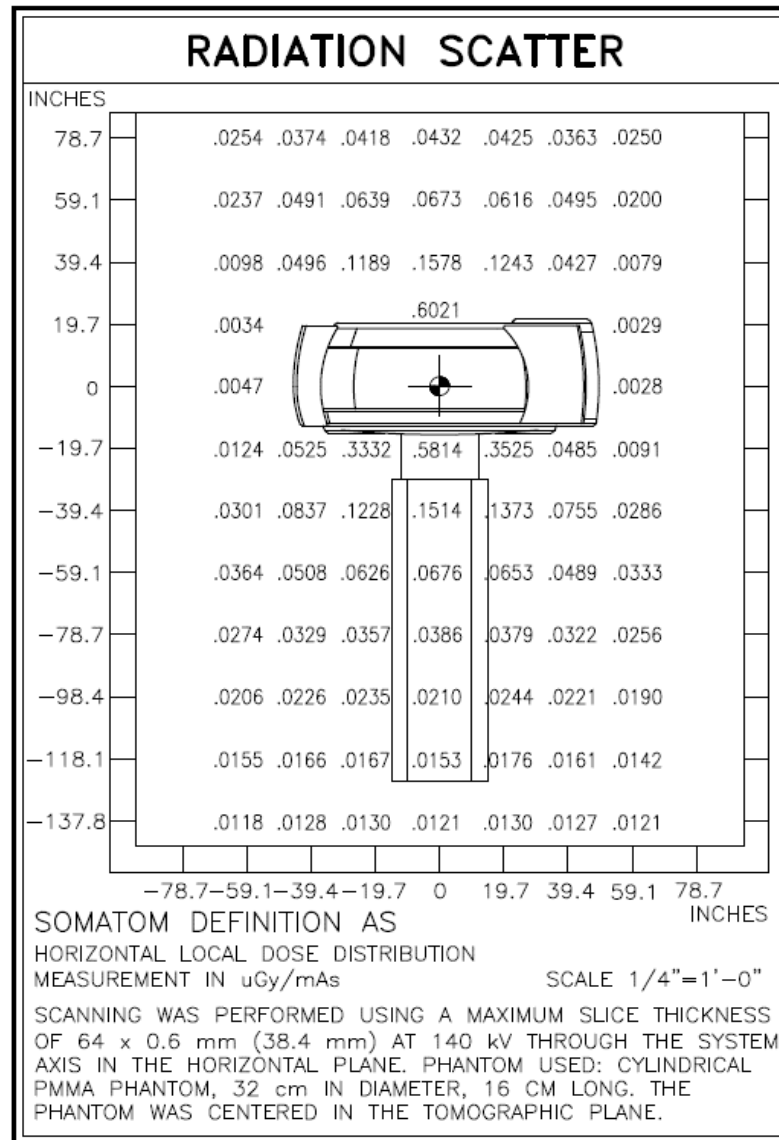

ISODOSE CURVES

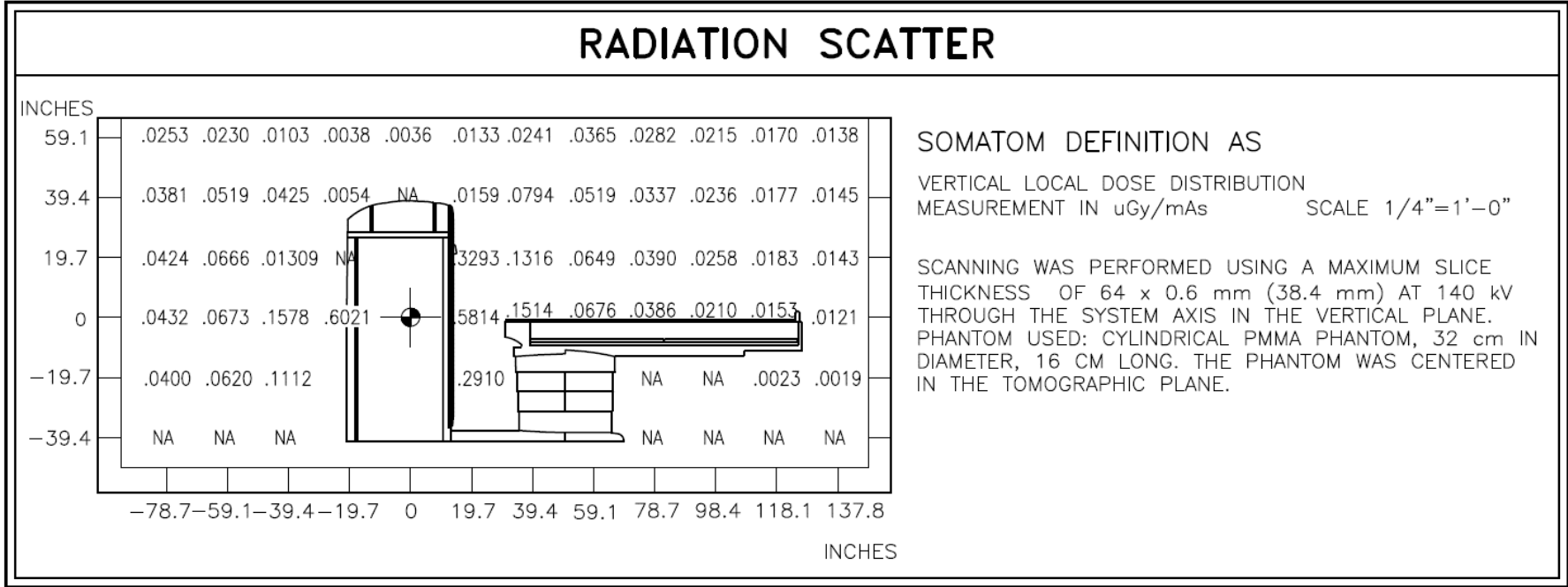

CT SCAN ROOM AS-BUILTS

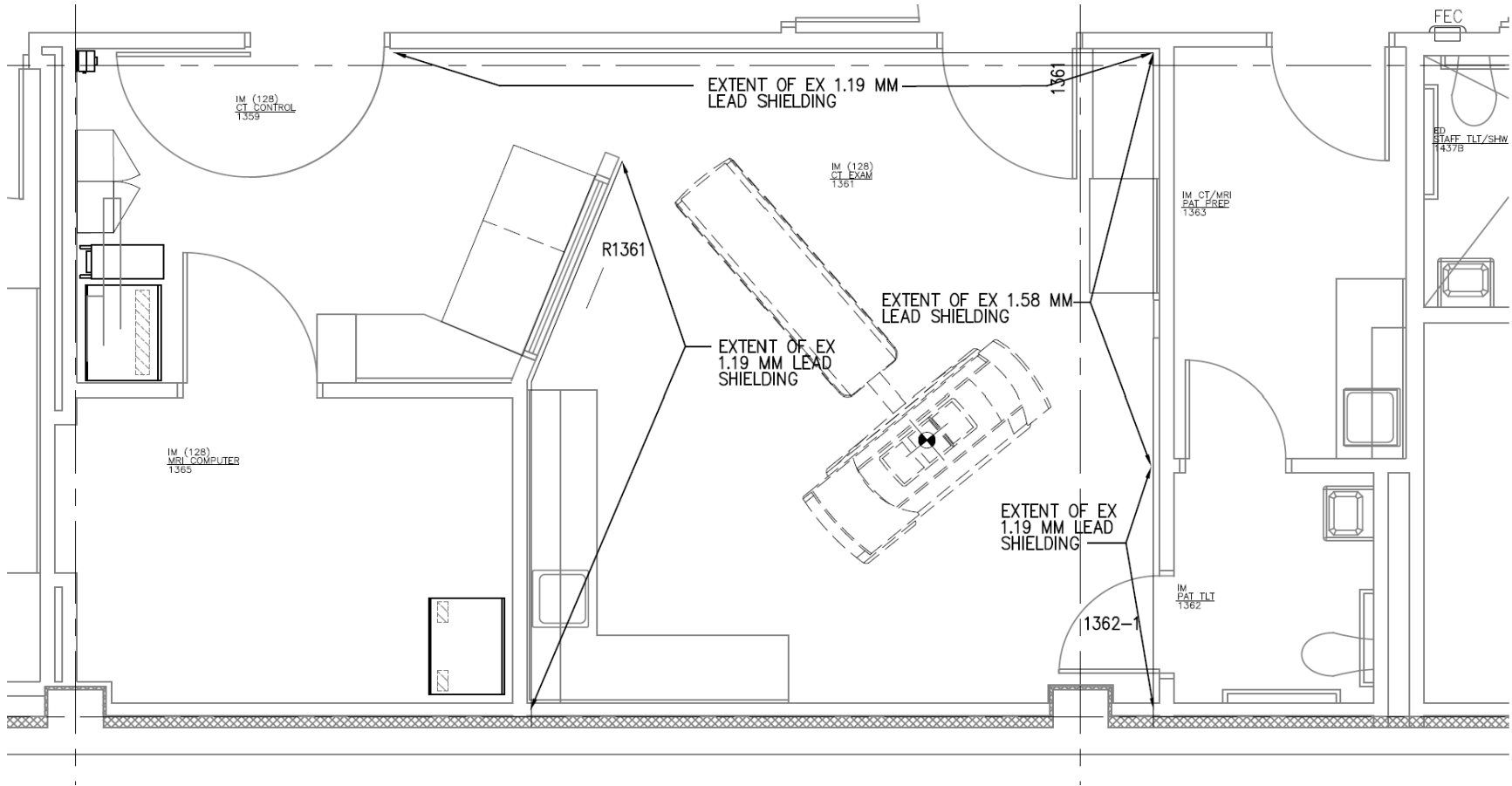

SCHEDULE OF COMMERCIAL LEAD THICKNESS & WEIGHT

Lead Sheet Thickness (Fractions of an Inch)	Decimal Equivalent	Millimeter Equivalent	Weight Nominal Pounds per Sq. Ft.
1/64"	0.0156"	0.04 mm	1 pound
1/32"	0.0312"	0.08 mm	2 pound
5/128"	0.0391"	0.10 mm	2.5 pound
3/64"	0.0469"	1.19 mm	3 pound
1/16"	0.0625"	1.59 mm	4 pound
5/64"	0.0781"	1.98 mm	5 pound
3/32"	0.0937"	2.38 mm	6 pound
1/8"	0.125"	3.18 mm	8 pound
5/32"	0.1562"	3.97 mm	10 pound
3/16"	0.1875"	4.76 mm	12 pound
1/4"	0.25"	6.35 mm	16 pound
3/8"	0.375"	9.53 mm	24 pound

City and Borough of Juneau

BARTLETT REGIONAL HOSPITAL MRI & CT REPLACEMENT

3260 Hospital Dr. Juneau, AK 99801

Project No.: 22008.01

BID DRAWINGS

Issue Date: 06-17-2022



AK Corp. Authorization AECC561

900 W. 5th Avenue, Suite 403
Anchorage, Alaska 99501-2029
907.272.3567 907.277.1732 fax

191 E. Swanson Avenue, Suite 203
Wasilla, Alaska 99654-7025
907.373.7503 907.376.3166 fax

104 E. Main Street, Suite 209
Bozeman, Montana 59715
406.404.1588

STRUCTURAL ENGINEERING

PND ENGINEERS, INC.

9360 GLACIER HIGHWAY, SUITE 100, JUNEAU, AK 99801

MECHANICAL ENGINEERING

AMC ENGINEERS

701 E TUDOR RD., SUITE 250, ANCHORAGE, AK 99503

ELECTRICAL ENGINEERING

AMC ENGINEERS

701 E TUDOR RD., SUITE 250, ANCHORAGE, AK 99503

BIM 360/1/2/1090.01 BRH Emergency Dept Add & Reno/21090.01 BRH ED Add & Reno.rvt
Plot Date Time: 7/7/2022 9:47:09 AM

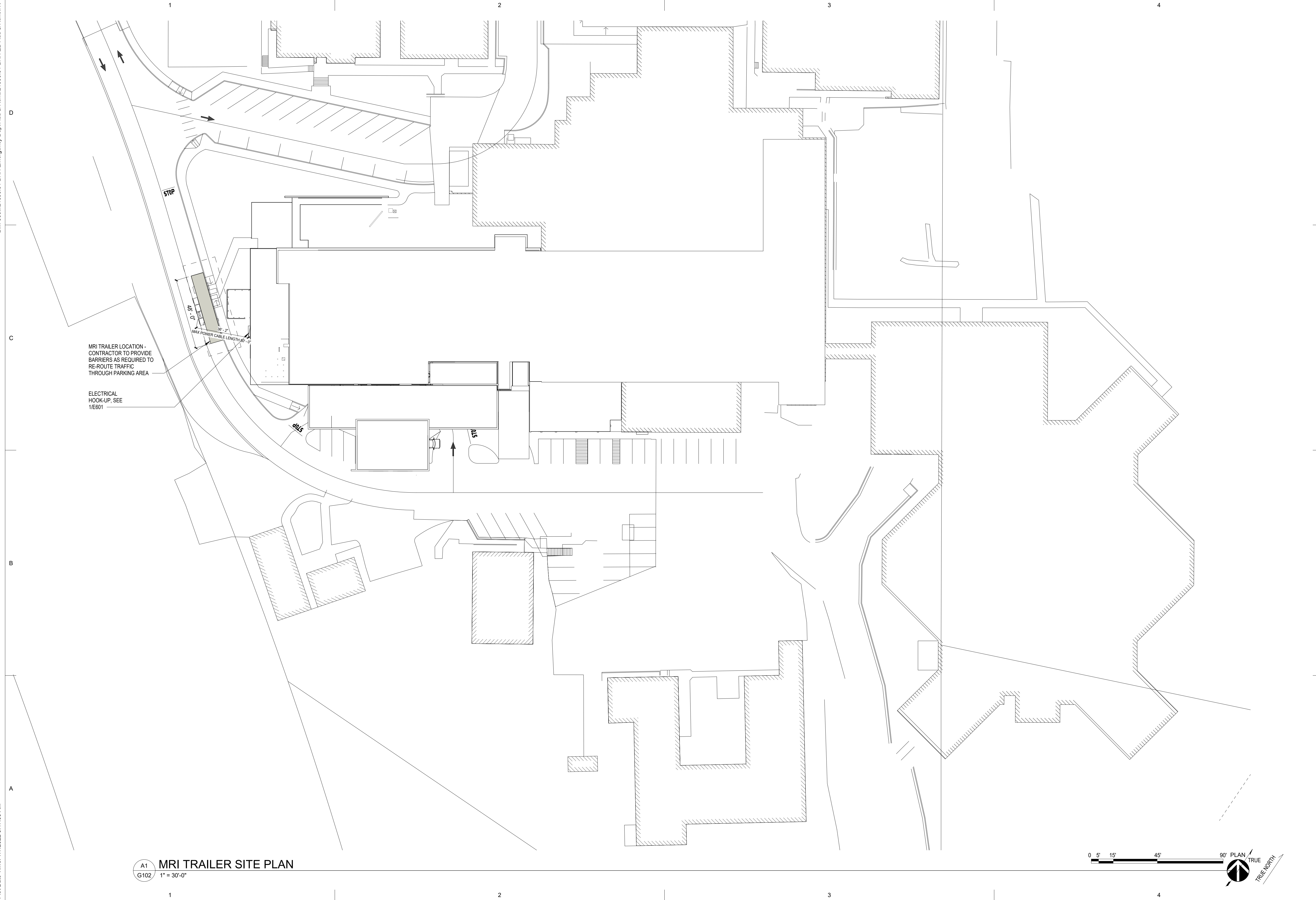

A1 MRI TRAILER SITE PLAN
G102 1" = 30'-0"

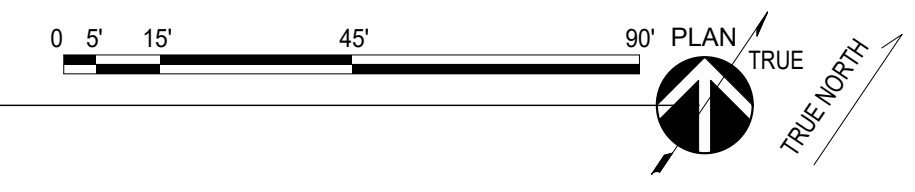

Architects Alaska
 ARCHITECTS ALASKA
 AK Corp. Authorization AECC561
 900 W. 5th Avenue, Suite 403
 Anchorage, Alaska 99501-2029
 907.272.3567 907.277.1732 fax
 191 E. Swanson Avenue, Suite 203
 Wasilla, Alaska 99564-7025
 907.373.7503 907.376.3166 fax
 347 S. Ferguson Ave, Suite 3
 Bozeman, Montana 59715
 406.404.1588
 www.architectsalaska.com

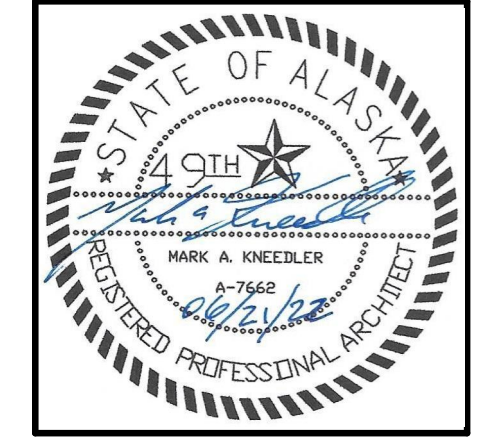

City and Borough of Juneau
BARTLETT REGIONAL HOSPITAL MRI & CT REPLACEMENT
 3260 Hospital Dr. Juneau, AK 99801

Revisions		
No.	Description	Date

Drawn by MR	Date 06-17-2022
Checked MAK	Job No. 22008.01

Sheet Contents
 MRI TRAILER SITE PLAN

Sheet No.
G102

BIM 360://21090.01 BRH Emergency Dept Add & Reno/21090.01 BRH ED Add & Reno.rvt

D

C

B

A

1

2

3

4

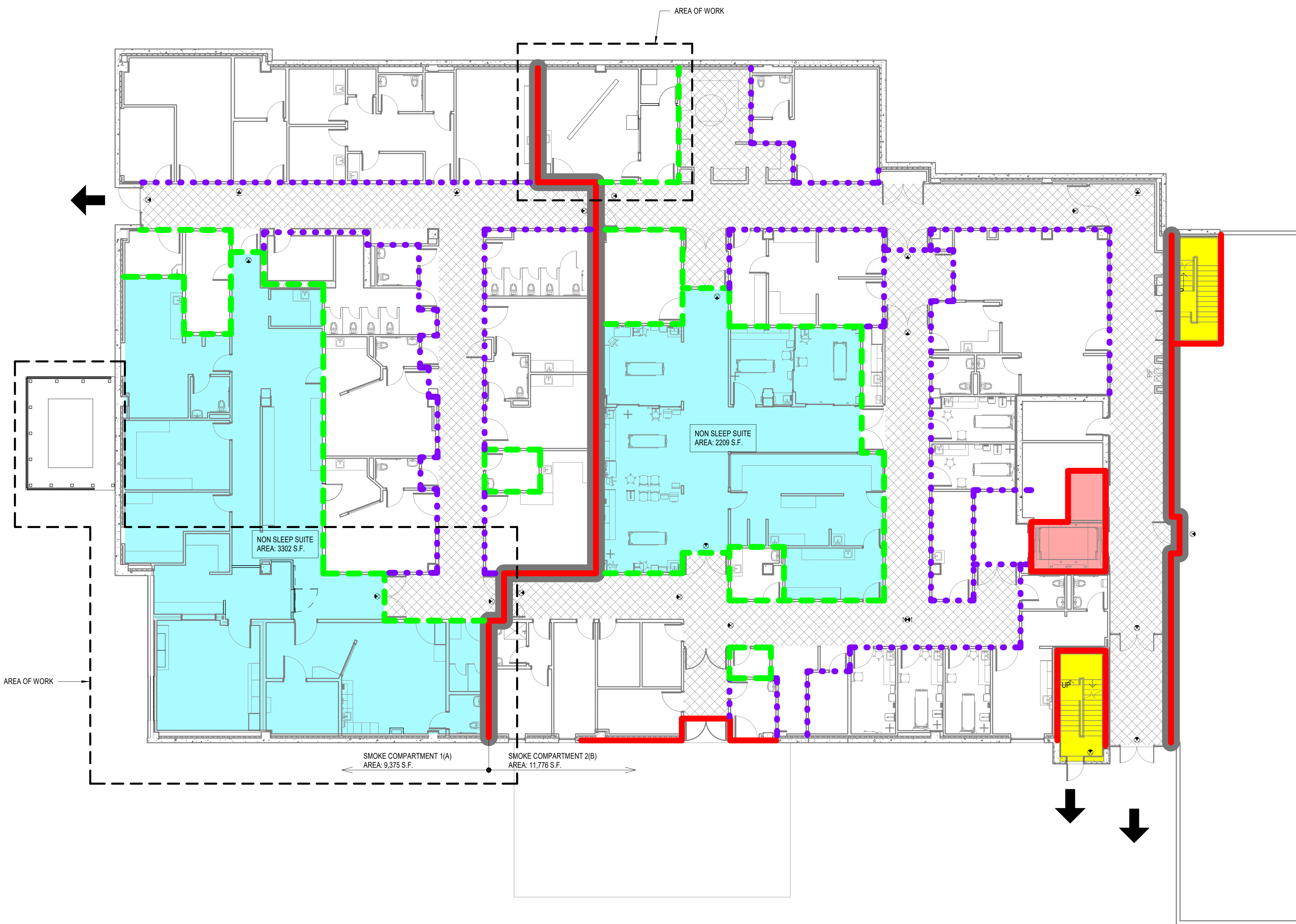

CODE INFORMATION

EXISTING BUILDING INFORMATION
CONSTRUCTION TYPE: TYPE I-B
OCCUPANCIES: I-2
 B (BOILER PLANT)
 A-2 (CAFETERIA)

BUILDING AREA:
 LEVEL 1: 45,534 SF
 LEVEL 2: 59,661 SF
 LEVEL 3: 35,084 SF
 LEVEL 4: 629 SF

BUILDING HEIGHT: 58 FEET
NUMBER OF STORIES: 4 STORIES

CODE INFORMATION:
APPLICABLE CODE: 2012 INTERNATIONAL EXISTING BUILDING CODE
 2012 NFPA 101 - LIFE SAFETY CODE
 2012 UNIFORM BUILDING CODE
 2012 INTERNATIONAL MECHANICAL CODE
 2011 NATIONAL ELECTRIC CODE
 2012 INTERNATIONAL FIRE CODE

CLASSIFICATION OF WORK:
 ALTERATION - LEVEL 1: CT-1, CT-2
 ALTERATION - LEVEL 2: MRI CONTROL ROOM, CHILLER

LIFE SAFETY PLAN LEGEND

- SMOKE BARRIER/SMOKE COMPARTMENT WALL
- 1-HOUR FIRE RATING
- 2-HOUR FIRE RATING
- SMOKE PARTITION
- HAZARDOUS AREA
- CORRIDOR (WALLS TO RESIST THE PASSAGE OF SMOKE)
- STAIR ENCLOSURE
- SHAFT ENCLOSURE
- NON-SLEEP SUITE
- EXIT DISCHARGE
- EXIT SIGN

Architects Alaska
ARCHITECTS ALASKA
 AK Corp. Authorization AECC561
 900 W. 5th Avenue, Suite 403
 Anchorage, Alaska 99501-2029
 907.272.3567 907.277.1732 fax

191 E. Swanson Avenue, Suite 203
 Wasilla, Alaska 99564-7025
 907.373.7503 907.376.3166 fax

347 S. Ferguson Ave, Suite 3
 Bozeman, Montana 59715
 406.404.1588
 www.architectsalaska.com



City and Borough of Juneau
BARTLETT REGIONAL HOSPITAL MRI & CT REPLACEMENT
 3260 Hospital Dr. Juneau, AK 99801

Revisions		
No.	Description	Date

Drawn by MR	Date 06-17-2022
Checked MAK	Job No. 22008.01

Sheet Contents
 LIFE SAFETY PLAN

Sheet No.
LS101

A1 LIFE SAFETY PLAN FIRST FLOOR
 3/32" = 1'-0"

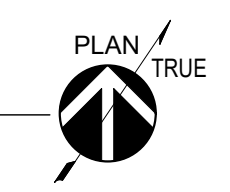

Plot Date Time: 6/21/2022 5:10:27 PM

BIM 360://21090.01 BRH Emergency Dept Add & Reno/21090.01 BRH ED Add & Reno.rvt

Plot Date Time: 6/21/2022 5:10:12 PM

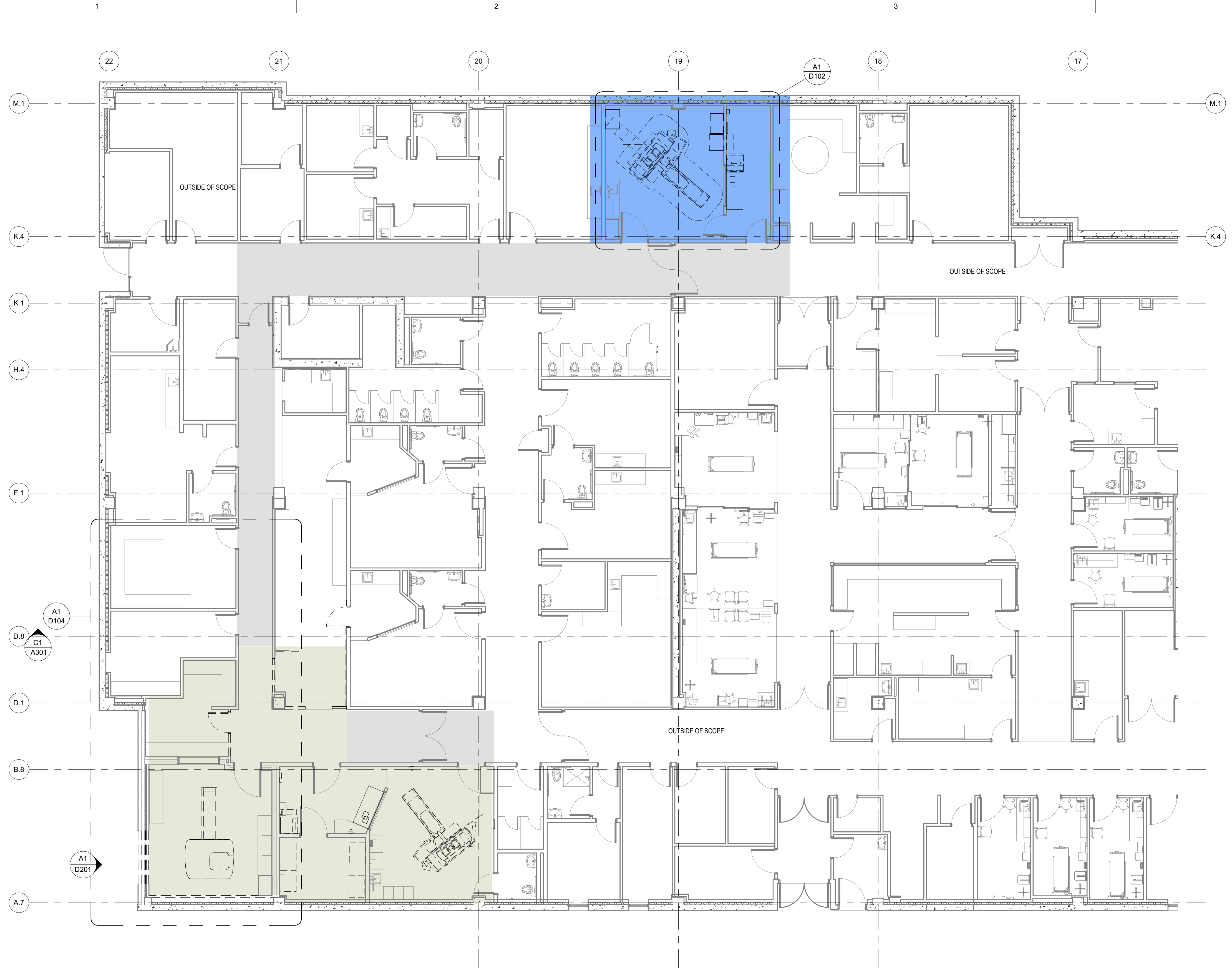

GENERAL NOTES

PHASE 1 REQUIRED TO BE CONSTRUCTED AND FULLY OPERATIONAL PRIOR TO START OF PHASE 2 WORK

PHASE 1: CT ROOM 1314A / CT CONTROL ROOM. ALL WORK REQUIRED FOR FULL OPERATION

PHASE 2: CT ROOM 1361 / CONTROL ROOM AND MRI ROOM 1358. ALL WORK REQUIRED FOR FULL OPERATION

AREA OF WORK REQUIRED TO SUPPORT PHASES 1 AND 2. CEILING SYSTEM & CEILING MOUNTED DEVICES SHALL BE REMOVED AND REPLACED AS REQUIRED FOR INSTALLATION OF MECHANICAL AND ELECTRICAL WORK

Architects Alaska.
ARCHITECTS ALASKA
 AK Corp. Authorization AECC561
 900 W. 5th Avenue, Suite 403
 Anchorage, Alaska 99501-2029
 907.272.3567 907.277.1732 fax
 191 E. Swanson Avenue, Suite 203
 Wasilla, Alaska 99564-7025
 907.373.7503 907.376.3166 fax
 347 S. Ferguson Ave, Suite 3
 Bozeman, Montana 59715
 406.404.1588
 www.architectsalaska.com



City and Borough of Juneau
BARTLETT REGIONAL HOSPITAL MRI & CT REPLACEMENT
 3260 Hospital Dr. Juneau, AK 99801

Revisions		
No.	Description	Date

Drawn by ARB	Date 06-17-2022
Checked MAK	Job No. 22008.01

Sheet Contents
 OVERALL & PHASING DEMOLITION PLAN

Sheet No.
D101

A1 D101 OVERALL & PHASING DEMOLITION PLAN FIRST FLOOR
 1/8" = 1'-0"

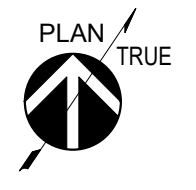

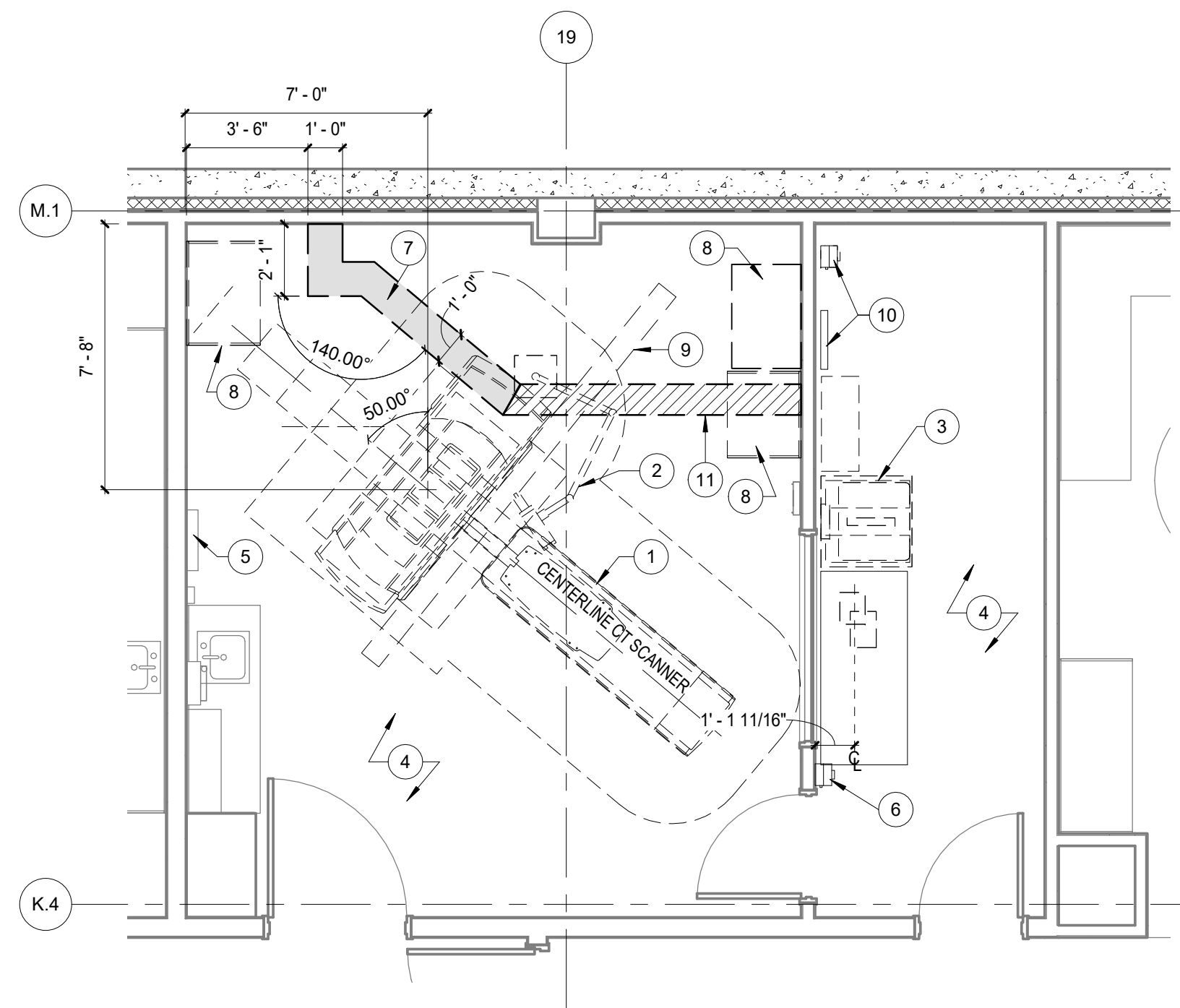

A1
D102
DEMOLITION PLAN - CT EXAM 1314A
1/4" = 1'-0"

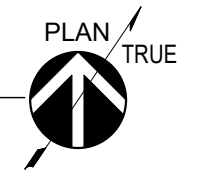

DEMOLITION SHEET FLAG NOTES

- 1 SIEMENS TO REMOVE CT AND ASSOCIATED EQUIPMENT & CONNECTIONS COMPLETELY.
- 2 CEILING MOUNTED INJECTOR TO REMAIN; OWNER TO REMOVE & RETAIN AS NECESSARY FOR RE-USE
- 3 SIEMENS TO REMOVE EXISTING CT CONTROLLERS AND EQUIPMENT. CONTRACTOR TO DEMO CONNECTION TO EQUIPMENT PER MECHANICAL AND ELECTRICAL DOCUMENTS
- 4 DEMOLISH FLOORING & BASE. PREPARE SUBSTRATE FOR NEW FLOORING
- 5 EXISTING MED GASES TO REMAIN
- 6 DEMOLISH EXISTING EMERGENCY STOP BUTTON, SEE ELECTRICAL FOR EXTENT OF WORK
- 7 SAW CUT CONCRETE SLAB AS REQUIRED FOR ELECTRICAL WORK, SEE ELECTRICAL & STRUCTURAL
- 8 REMOVE CASEWORK, RETURN TO OWNER
- 9 FLOOR MTD LASER TO REMAIN; CONTRACTOR TO REMOVE & RETAIN AS NECESSARY FOR RE-USE
- 10 DEMOLISH EXISTING PANEL & ASSOCIATED CONDUCTORS, SEE ELECTRICAL
- 11 DEMOLISH EXISTING FLOOR TRENCH AS REQUIRED TO ALLOW FOR NEW FLOOR TRENCH, SEE ELECTRICAL

GENERAL NOTES

1. NO CHANGES TO EXISTING CASEWORK U.N.O.
2. ANY DAMAGE INCURRED FROM DEMO WORK TO EXISTING SHIELDING SHALL BE REPAIRED TO MATCH EXISTING SHIELDING WEIGHT

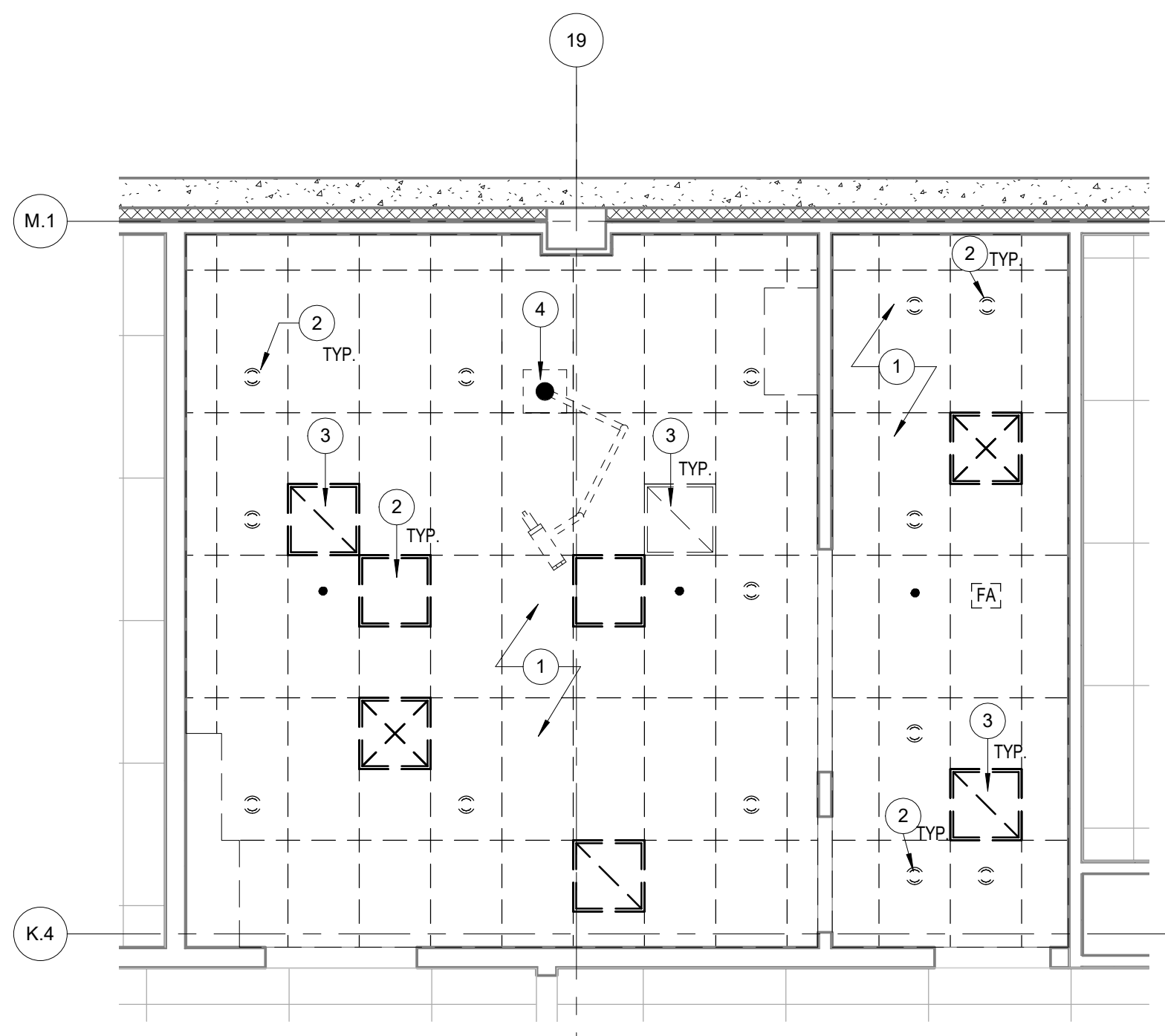

C1
D102
DEMOLITION REFLECTED CEILING PLAN - CT EXAM 1314A
1/4" = 1'-0"

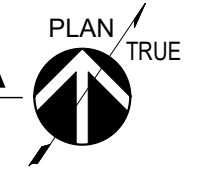

DEMOLITION REFLECTED CEILING PLAN SHEET FLAG NOTES

- 1 DEMOLISH SUSPENDED ACOUSTICAL CEILING TILE & GRID
- 2 DEMOLISH LIGHT FIXTURE, SEE ELECTRICAL
- 3 DEMOLISH SUPPLY/RETURN AIR GRILLE, SEE MECHANICAL
- 4 INJECTOR TO REMAIN; CONTRACTOR TO REMOVE & RETAIN AS NECESSARY FOR RE-USE

DEMOLITION REFLECTED CEILING PLAN LEGEND

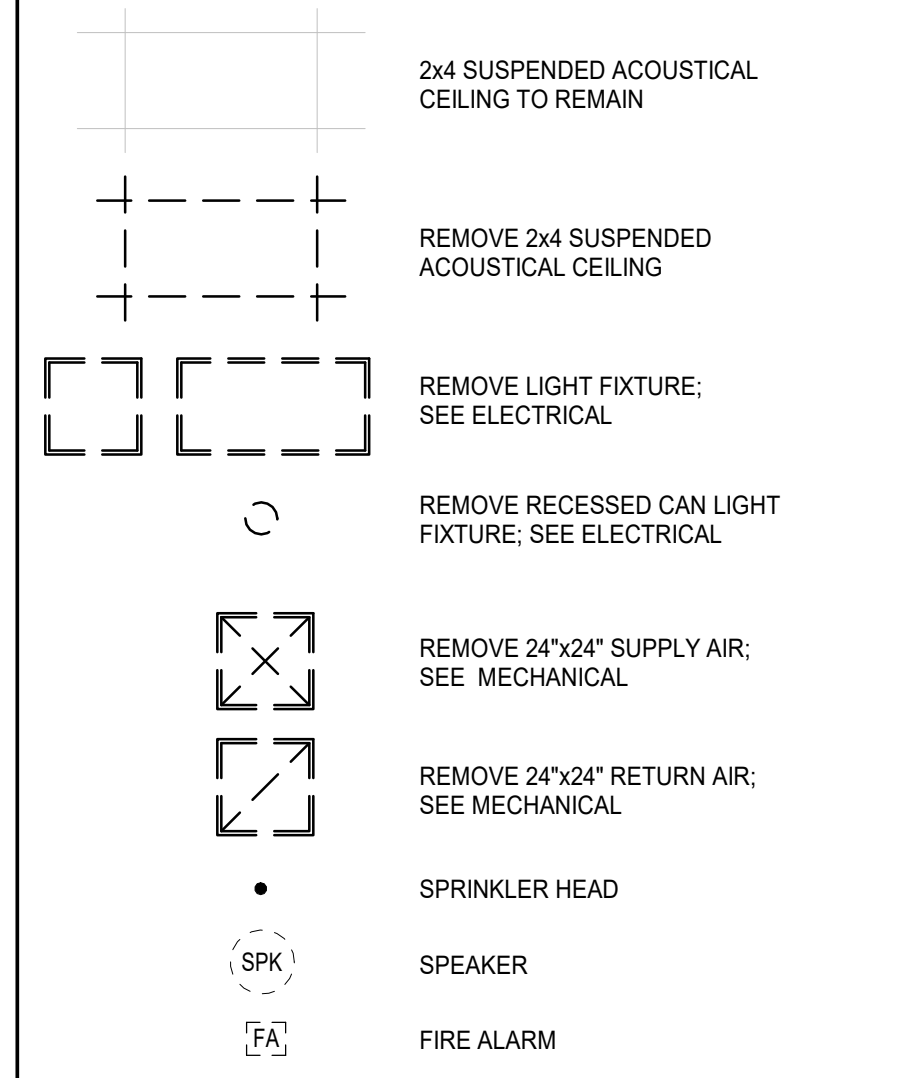

GENERAL NOTES

1. REMOVE CEILING MOUNTED DEVICES TO ACCOMMODATE REPLACEMENT OF CEILING TILES & GRID. REINSTALL CEILING DEVICES AND RECONNECT TO EXISTING CIRCUITS UPON COMPLETION OF CEILING INSTALLATION.

Architects Alaska
 ARCHITECTS ALASKA
 AK Corp. Authorization AECC561
 900 W. 5th Avenue, Suite 403
 Anchorage, Alaska 99501-2029
 907.272.3567 907.277.1732 fax
 191 E. Swanson Avenue, Suite 203
 Wasilla, Alaska 99564-7025
 907.373.7503 907.376.3166 fax
 347 S. Ferguson Ave, Suite 3
 Bozeman, Montana 59715
 406.404.1588
 www.architectsalaska.com

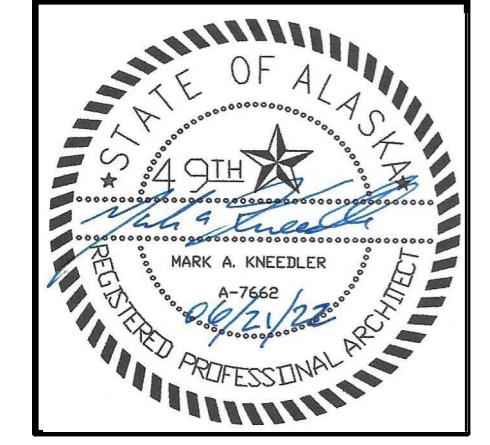

City and Borough of Juneau
BARTLETT REGIONAL HOSPITAL MRI & CT REPLACEMENT
 3260 Hospital Dr. Juneau, AK 99801

Revisions		
No.	Description	Date

Drawn by MR	Date 06-17-2022
Checked MAK	Job No. 22008.01

Sheet Contents DEMOLITION PLANS - CT 1314A

Sheet No.
D102

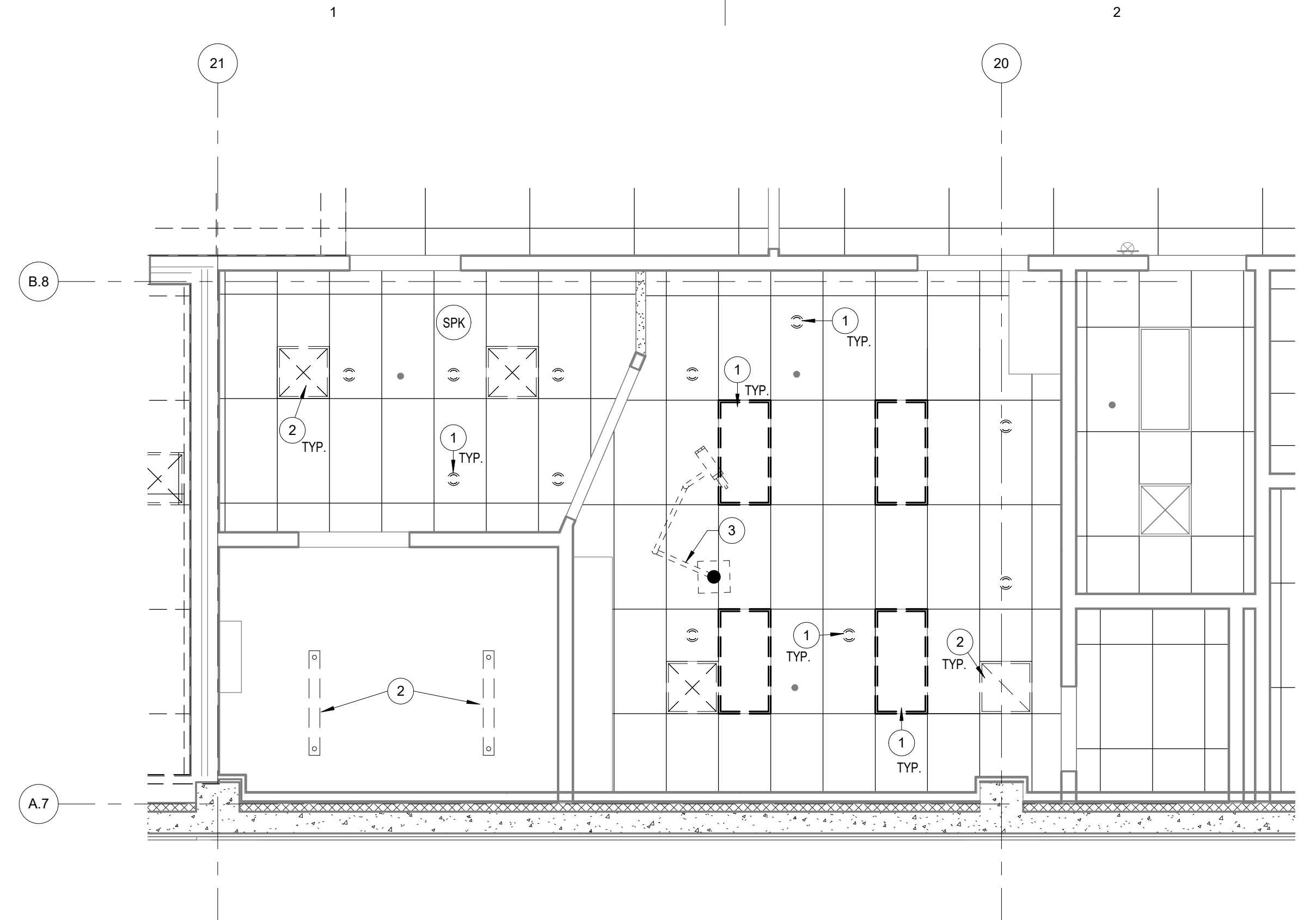

C1 DEMOLITION REFLECTED CEILING PLAN - CT EXAM 1361
D103 1/4" = 1'-0"

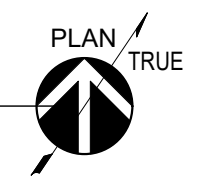

- DEMOLITION REFLECTED CEILING PLAN SHEET FLAG NOTES**
- 1 DEMOLISH LIGHT FIXTURE, SEE ELECTRICAL
 - 2 DEMOLISH SUPPLY/RETURN AIR GRILLE, SEE MECHANICAL
 - 3 INJECTOR TO REMAIN; CONTRACTOR TO REMOVE & RETAIN AS NECESSARY FOR RE-USE

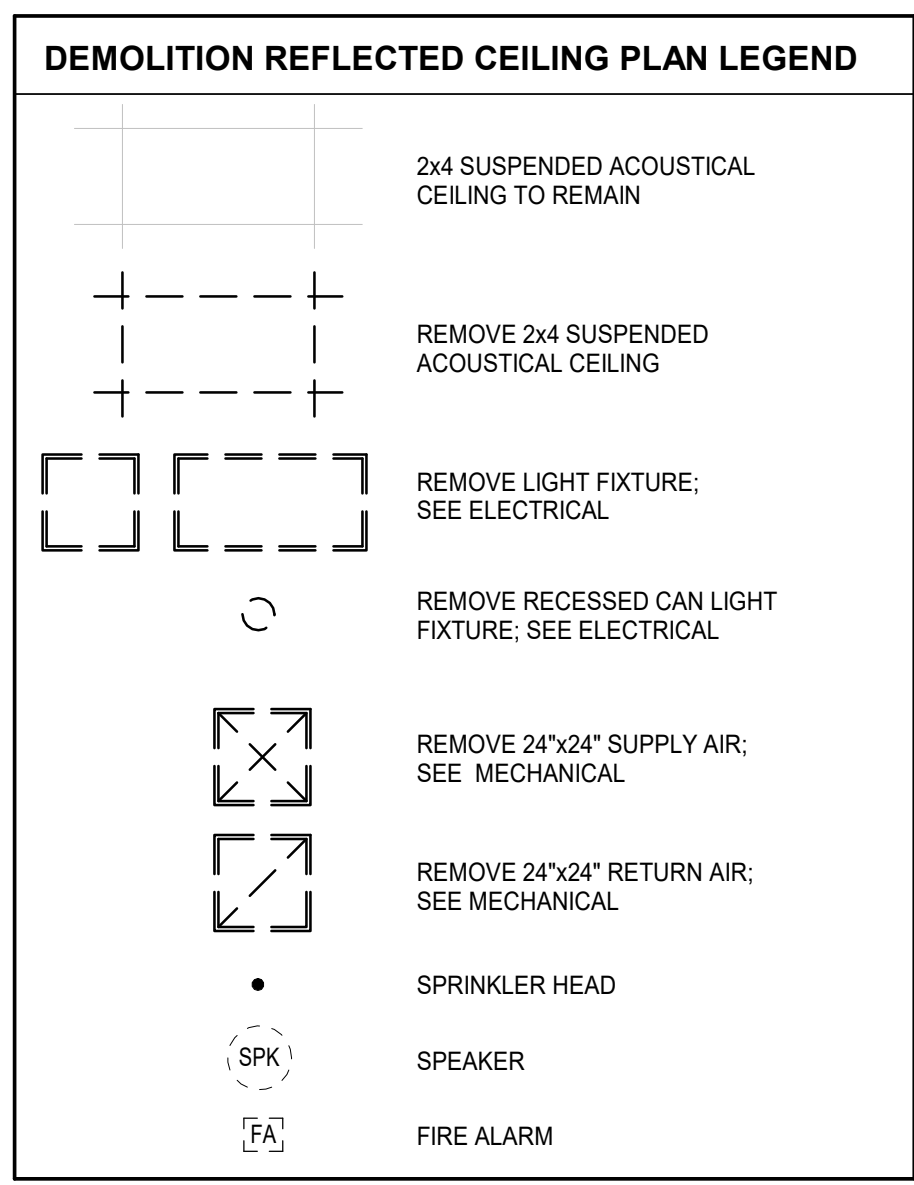

- GENERAL NOTES**
1. REMOVE CEILING MOUNTED DEVICES TO ACCOMMODATE REPLACEMENT OF CEILING TILES & GRID. REINSTALL CEILING DEVICES AND RECONNECT TO EXISTING CIRCUITS UPON COMPLETION OF CEILING INSTALLATION.

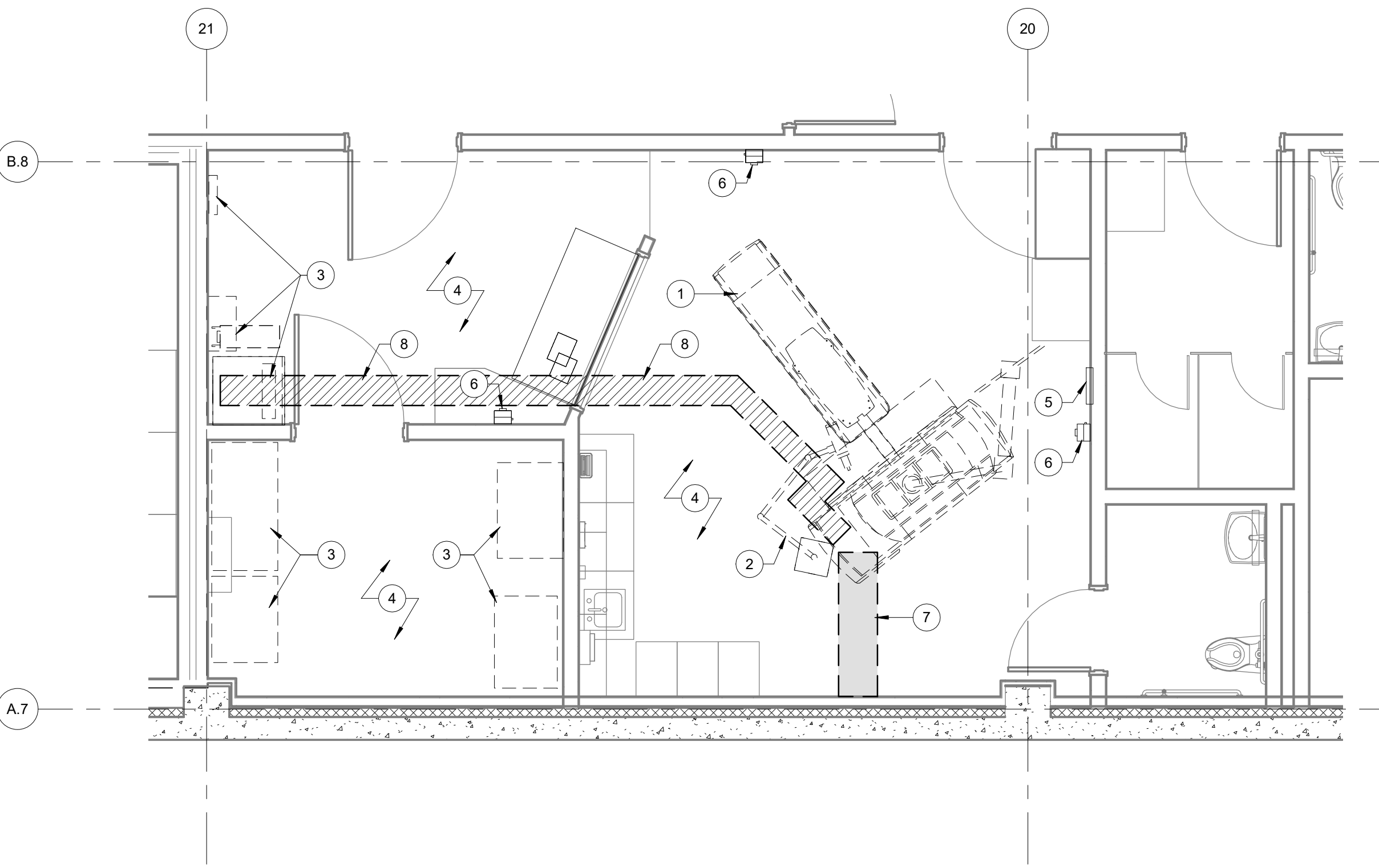

A1 DEMOLITION PLAN - CT EXAM 1361
D103 1/4" = 1'-0"

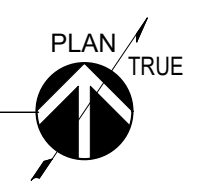

- DEMOLITION SHEET FLAG NOTES**
- 1 SIEMENS TO REMOVE CT AND ASSOCIATED EQUIPMENT & CONNECTIONS COMPLETELY.
 - 2 CEILING MOUNTED INJECTOR TO REMAIN; CONTRACTOR TO REMOVE & RETAIN AS NECESSARY FOR RE-USE
 - 3 SIEMENS TO REMOVE EXISTING MRI & CT CONTROLLERS AND EQUIPMENT. CONTRACTOR TO DEMO CONNECTION TO EQUIPMENT PER MECHANICAL AND ELECTRICAL DOCUMENTS
 - 4 DEMOLISH FLOORING & BASE. PREPARE SUBSTRATE FOR NEW FLOORING
 - 5 EXISTING MED GASES TO REMAIN
 - 6 DEMOLISH EXISTING EMERGENCY STOP BUTTON, SEE ELECTRICAL FOR EXTENT OF WORK
 - 7 SAW CUT CONCRETE SLAB AS REQUIRED FOR ELECTRICAL WORK, SEE ELECTRICAL & STRUCTURAL
 - 8 REMOVE EXISTING TRENCH DUCT. INFILL WITH CONCRETE TO MATCH EXISTING. SEE ELECTRICAL FOR EXTENTS

- GENERAL NOTES**
1. NO CHANGES TO EXISTING CASEWORK U.N.O.
 2. ANY DAMAGE INCURRED FROM DEMO WORK TO EXISTING SHIELDING SHALL BE REPAIRED TO MATCH EXISTING SHIELDING WEIGHT

Architects Alaska.
ARCHITECTS ALASKA
AK Corp. Authorization AECC561
900 W. 5th Avenue, Suite 403
Anchorage, Alaska 99501-2029
907.272.3567 907.277.1732 fax
191 E. Swanson Avenue, Suite 203
Wasilla, Alaska 99564-7025
907.373.7503 907.376.3166 fax
347 S. Ferguson Ave, Suite 3
Bozeman, Montana 59715
406.404.1588
www.architectsalaska.com

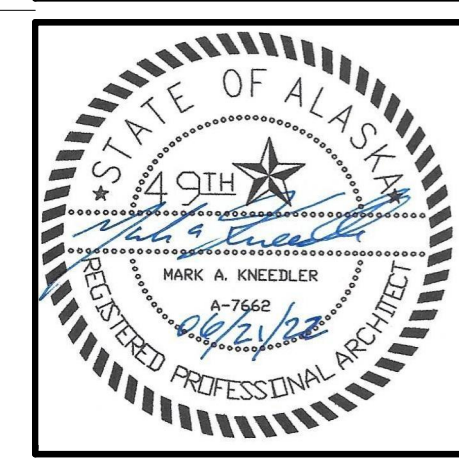

City and Borough of Juneau
BARTLETT REGIONAL HOSPITAL MRI & CT REPLACEMENT
3260 Hospital Dr. Juneau, AK 99801

Revisions

No.	Description	Date

Drawn by Author	Date 06-17-2022
Checked Checker	Job No. 22008.01

Sheet Contents
DEMOLITION PLANS - CT 1361

Sheet No.
D103

BIM 360/1/21090.01 BRH Emergency Dept Add & Reno/21090.01 BRH ED Add & Reno.rvt

Plot Date Time: 6/21/2022 5:10:16 PM

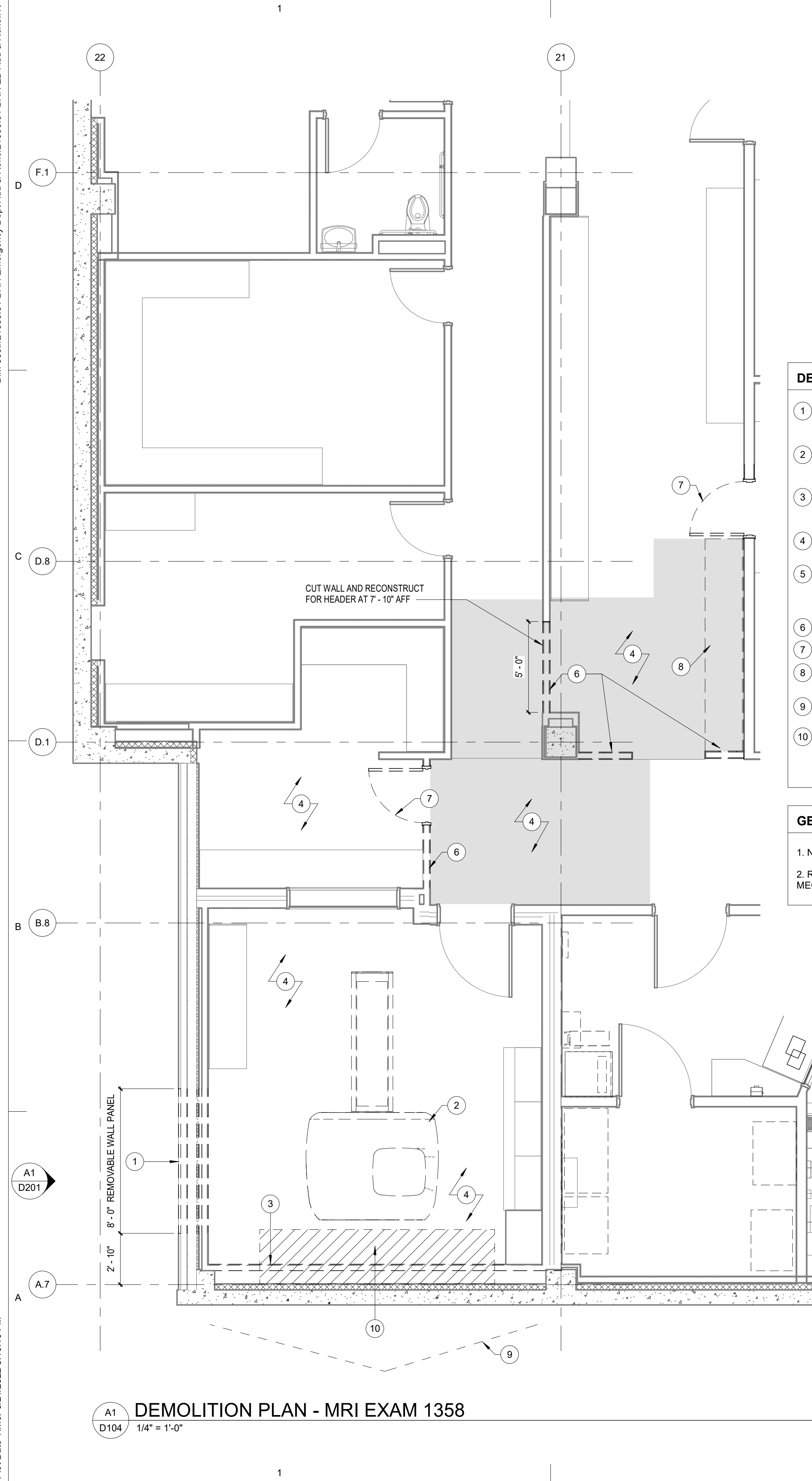

- DEMOLITION SHEET FLAG NOTES**
- 1 REMOVE WALL & SHIELDING AS REQUIRED FOR REMOVAL & INSTALLATION OF NEW MRI. RETAIN KNOCK-DOWN WALL FOR RE-INSTALLATION
 - 2 SIEMENS TO REMOVE MAGNET AND ASSOCIATED EQUIPMENT & CONNECTIONS COMPLETELY
 - 3 DEMOLISH EXISTING FURRED WALL AND RF SHIELDING AS REQUIRED TO INSTALL MAGNETIC SHIELDING
 - 4 DEMOLISH FLOORING & BASE. PREPARE SUBSTRATE FOR NEW FLOORING
 - 5 SIEMENS TO REMOVE EXISTING CT & MRI CONTROLLERS AND EQUIPMENT. CONTRACTOR TO DEMO CONNECTION TO EQUIPMENT PER MECHANICAL AND ELECTRICAL DOCUMENTS
 - 6 DEMOLISH WALL COMPLETE
 - 7 DEMOLISH DOOR, FRAME & HARDWARE
 - 8 REMOVE CASEWORK & EQUIPMENT; RETURN TO OWNER
 - 9 REMOVE & DISPOSE OF EXISTING CHAIN-LINK FENCE
 - 10 DEMOLISH EXISTING RF FLOOR AND MODIFY SLAB AS REQUIRED TO INSTALL MAGNETIC SHIELDING

- GENERAL NOTES**
1. NO CHANGES TO EXISTING CASEWORK U.N.O.
 2. REMOVE ABANDONED ROOFTOP CHILLER, SEE MECHANICAL

A1
D104
DEMOLITION PLAN - MRI EXAM 1358
1/4" = 1'-0"

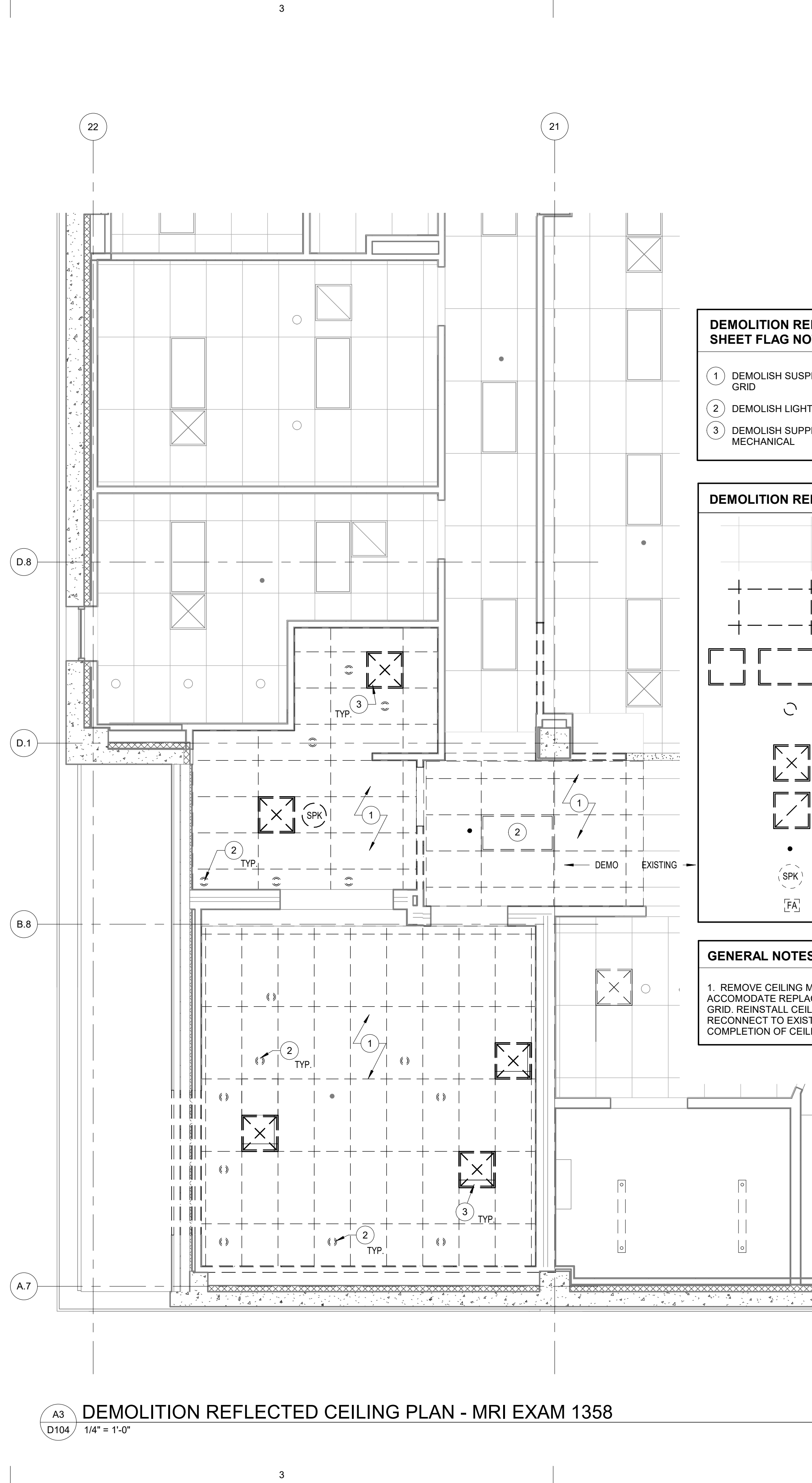
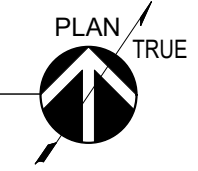

- DEMOLITION REFLECTED CEILING PLAN SHEET FLAG NOTES**
- 1 DEMOLISH SUSPENDED ACOUSTICAL CEILING TILE & GRID
 - 2 DEMOLISH LIGHT FIXTURE, SEE ELECTRICAL
 - 3 DEMOLISH SUPPLY/RETURN AIR GRILLE, SEE MECHANICAL

DEMOLITION REFLECTED CEILING PLAN LEGEND

	2x4 SUSPENDED ACOUSTICAL CEILING TO REMAIN
	REMOVE 2x4 SUSPENDED ACOUSTICAL CEILING
	REMOVE LIGHT FIXTURE; SEE ELECTRICAL
	REMOVE RECESSED CAN LIGHT FIXTURE; SEE ELECTRICAL
	REMOVE 24"x24" SUPPLY AIR; SEE MECHANICAL
	REMOVE 24"x24" RETURN AIR; SEE MECHANICAL
	SPRINKLER HEAD
	SPEAKER
	FIRE ALARM

- GENERAL NOTES**
1. REMOVE CEILING MOUNTED DEVICES TO ACCOMMODATE REPLACEMENT OF CEILING TILES & GRID. REINSTALL CEILING DEVICES AND RECONNECT TO EXISTING CIRCUITS UPON COMPLETION OF CEILING INSTALLATION.

A3
D104
DEMOLITION REFLECTED CEILING PLAN - MRI EXAM 1358
1/4" = 1'-0"

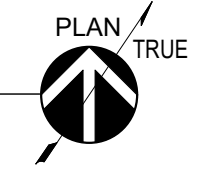

Architects Alaska
ARCHITECTS ALASKA
AK Corp. Authorization AECC561
900 W. 5th Avenue, Suite 403
Anchorage, Alaska 99501-2029
907.272.3567 907.277.1732 fax
191 E. Swanson Avenue, Suite 203
Wasilla, Alaska 99564-7025
907.373.7503 907.376.3166 fax
347 S. Ferguson Ave, Suite 3
Bozeman, Montana 59715
406.404.1588
www.architectsalaska.com



City and Borough of Juneau
BARTLETT REGIONAL HOSPITAL MRI & CT REPLACEMENT
3260 Hospital Dr. Juneau, AK 99801

Revisions

No.	Description	Date

Drawn by ARB	Date 06-17-2022
Checked MAK	Job No. 22008.01

Sheet Contents
DEMOLITION PLANS - MRI 1358

Sheet No.
D104

BIM 360://21090.01 BRH Emergency Dept Add & Reno/21090.01 BRH ED Add & Reno.rvt

C

B

A

1

2

3

4

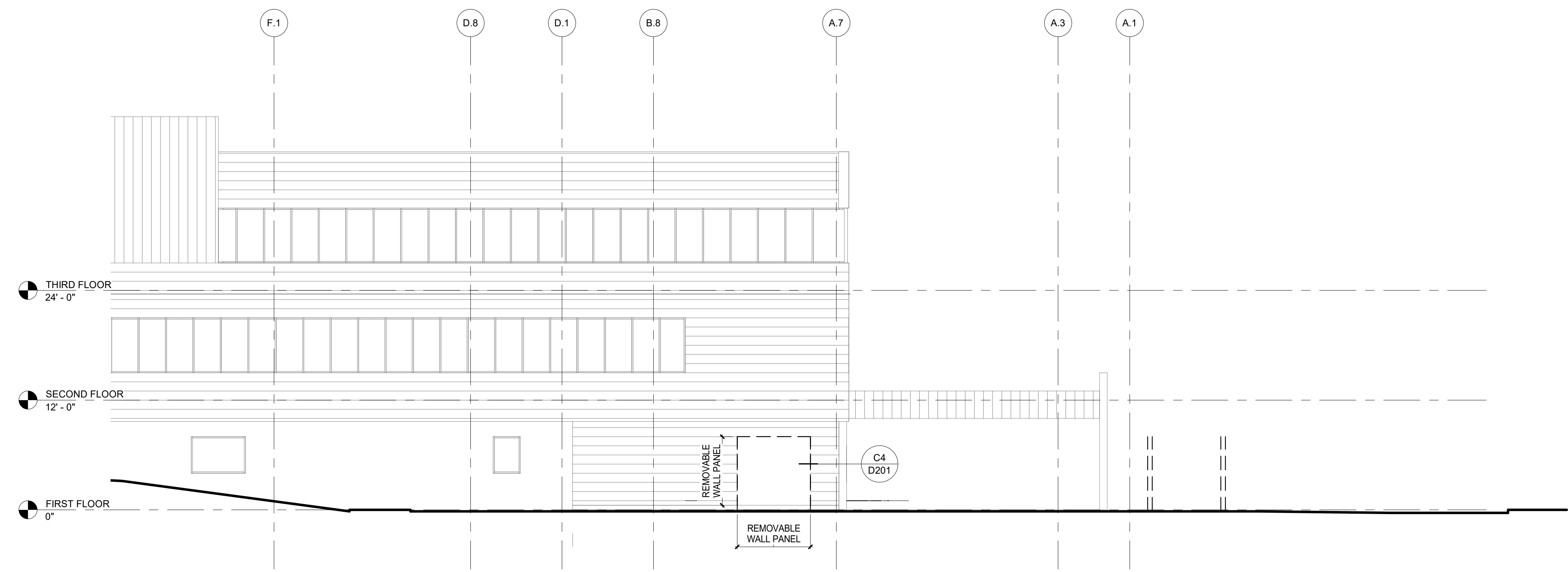

A1
D201 EXTERIOR ELEVATION - DEMOLITION WEST
 1/8" = 1'-0"

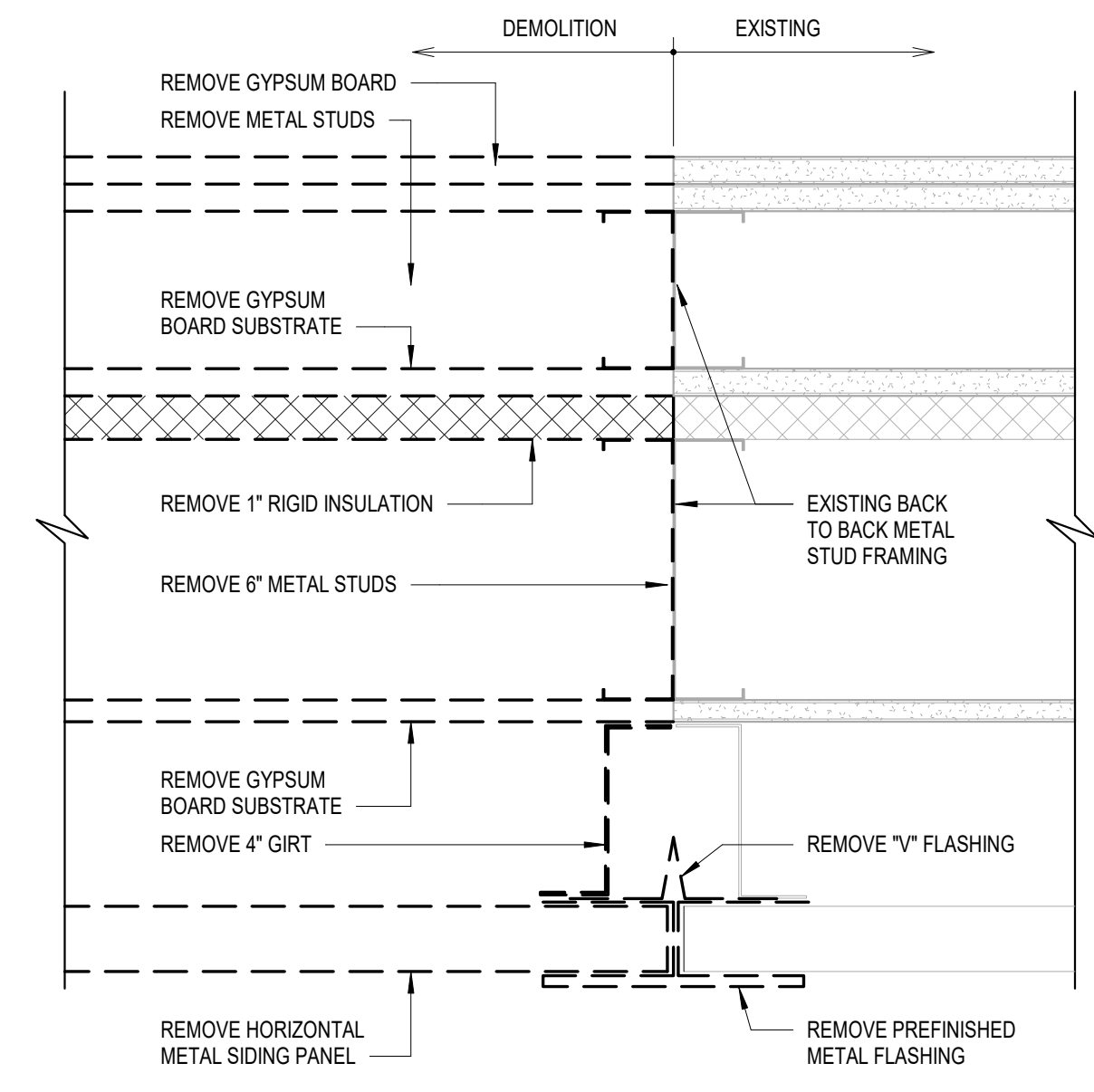

C4
D201 VERTICAL JOINT AT HORIZONTAL SIDING DEMOLITION
 3" = 1'-0"



ARCHITECTS ALASKA
 AK Corp. Authorization AECC561
 900 W. 5th Avenue, Suite 403
 Anchorage, Alaska 99501-2029
 907.272.3567 907.277.1732 fax
 191 E. Swanson Avenue, Suite 203
 Wasilla, Alaska 99564-7025
 907.373.7503 907.376.3166 fax
 347 S. Ferguson Ave, Suite 3
 Bozeman, Montana 59715
 406.404.1588
 www.architectsalaska.com

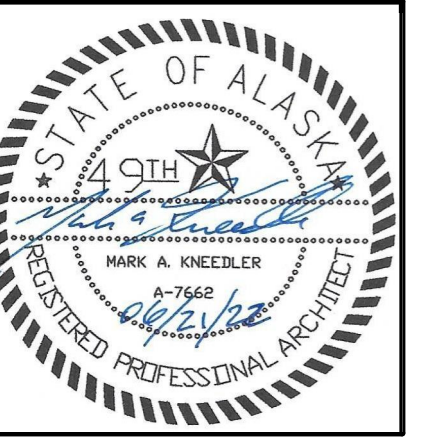

City and Borough of Juneau
**BARTLETT REGIONAL HOSPITAL MRI
 & CT REPLACEMENT**
 3260 Hospital Dr. Juneau, AK 99801

Revisions		
No.	Description	Date

Drawn by Author	Date 06-17-2022
Checked Checker	Job No. 22008.01

Sheet Contents
 DEMOLITION EXTERIOR ELEVATION

Sheet No.
D201

Plot Date Time: 6/21/2022 5:10:17 PM

BIM 360://21090.01 BRH Emergency Dept Add & Reno/21090.01 BRH ED Add & Reno.rvt

Plot Date Time: 6/21/2022 5:09:56 PM

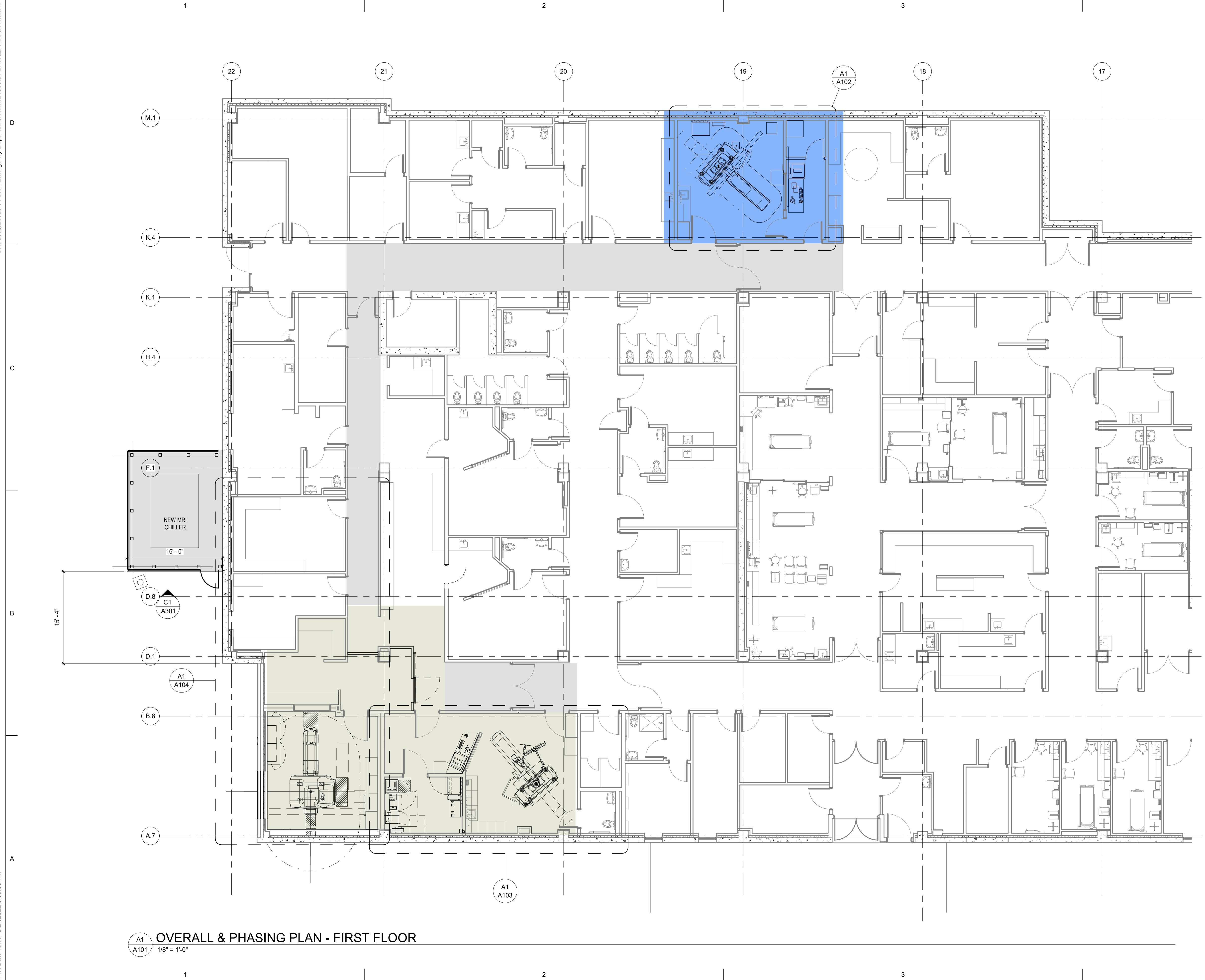

GENERAL NOTES

PHASE 1 REQUIRED TO BE CONSTRUCTED AND FULLY OPERATIONAL PRIOR TO START OF PHASE 2 WORK

PHASE 1: CT ROOM 1314A / CT CONTROL ROOM. ALL WORK REQUIRED FOR FULL OPERATION

PHASE 2: CT ROOM 1361 / CONTROL ROOM AND MRI ROOM 1358. ALL WORK REQUIRED FOR FULL OPERATION

SUPPORT AREA: AREA OF WORK REQUIRED TO SUPPORT PHASES 1 AND 2. CEILING SYSTEM & CEILING MOUNTED DEVICES SHALL BE REMOVED AND REPLACED AS REQUIRED FOR INSTALLATION OF MECHANICAL AND ELECTRICAL WORK

Architects Alaska
ARCHITECTS ALASKA
 AK Corp. Authorization AECC651
 900 W. 5th Avenue, Suite 403
 Anchorage, Alaska 99501-2029
 907.272.3567 907.277.1732 fax
 191 E. Swanson Avenue, Suite 203
 Wasilla, Alaska 99564-7025
 907.373.7503 907.376.3166 fax
 347 S. Ferguson Ave, Suite 3
 Bozeman, Montana 59715
 406.404.1588
 www.architectsalaska.com

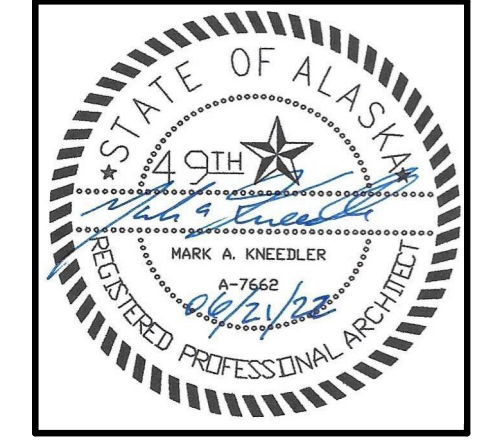

City and Borough of Juneau
BARTLETT REGIONAL HOSPITAL MRI & CT REPLACEMENT
 3260 Hospital Dr. Juneau, AK 99801

Revisions

No.	Description	Date

Drawn by Author	Date 06-17-2022
Checked Checker	Job No. 22008.01

Sheet Contents
 OVERALL & PHASING PLAN - FIRST FLOOR

Sheet No.
A101

A1 OVERALL & PHASING PLAN - FIRST FLOOR
 A101 1/8" = 1'-0"

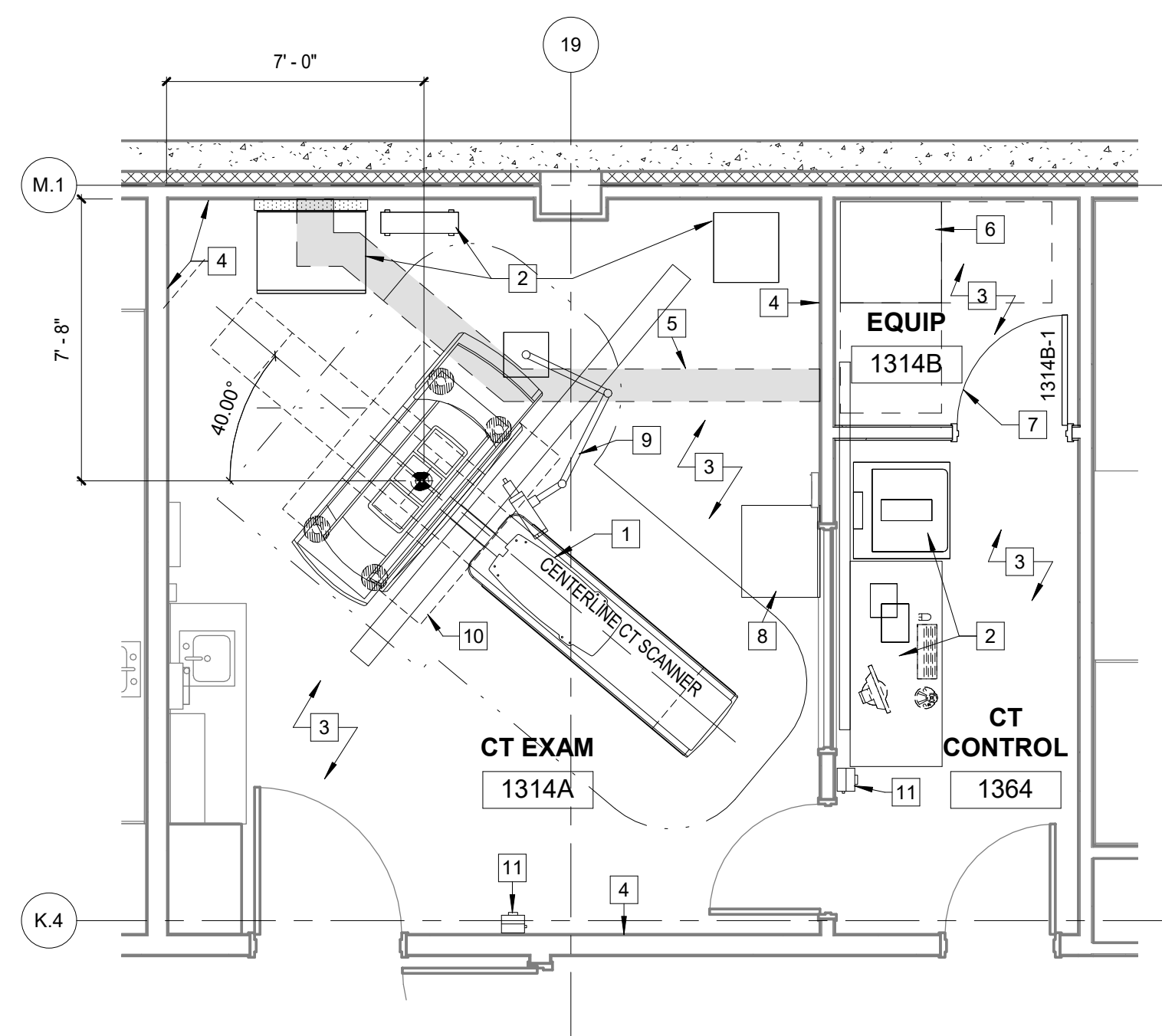

A1
A102
NEW PLAN - CT EXAM 1314A
1/4" = 1'-0"

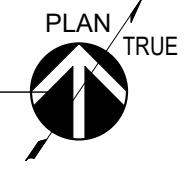

- SHEET FLAG NOTES**
- 1 NEW CT, INSTALLATION BY SIEMENS
 - 2 SIEMENS TO INSTALL NEW CONTROLLERS AND EQUIPMENT. CONTRACTOR TO COORDINATE CONNECTION TO EQUIPMENT PER MECHANICAL AND ELECTRICAL DOCUMENTS
 - 3 NEW CONDUCTIVE SHEET VINYL FLOORING W/ RUBBER BASE, SEE FLOOR FINISH PLAN A105
 - 4 NEW 4' HIGH IMPACT RESISTANT WALL PROTECTION, SEE FLOOR FINISH PLAN A105
 - 5 NEW ELECTRICAL TRENCH DUCT, SEE ELECTRICAL
 - 6 NEW COOLING UNIT, SEE MECHANICAL
 - 7 NEW DOOR, FRAME & PASSAGE HARDWARE
 - 8 CONTRACTOR TO REINSTALL DESK
 - 9 CONTRACTOR TO REINSTALL INJECTOR
 - 10 CONTRACTOR TO REINSTALL LASER
 - 11 NEW EMERGENCY SHUTDOWN BUTTONS, SEE ELECTRICAL

- GENERAL NOTES**
1. PATCH WALLS AS NECESSARY DUE TO DEMO WORK
 2. PAINT ENTIRE ROOM, SEE FINISH SCHEDULE

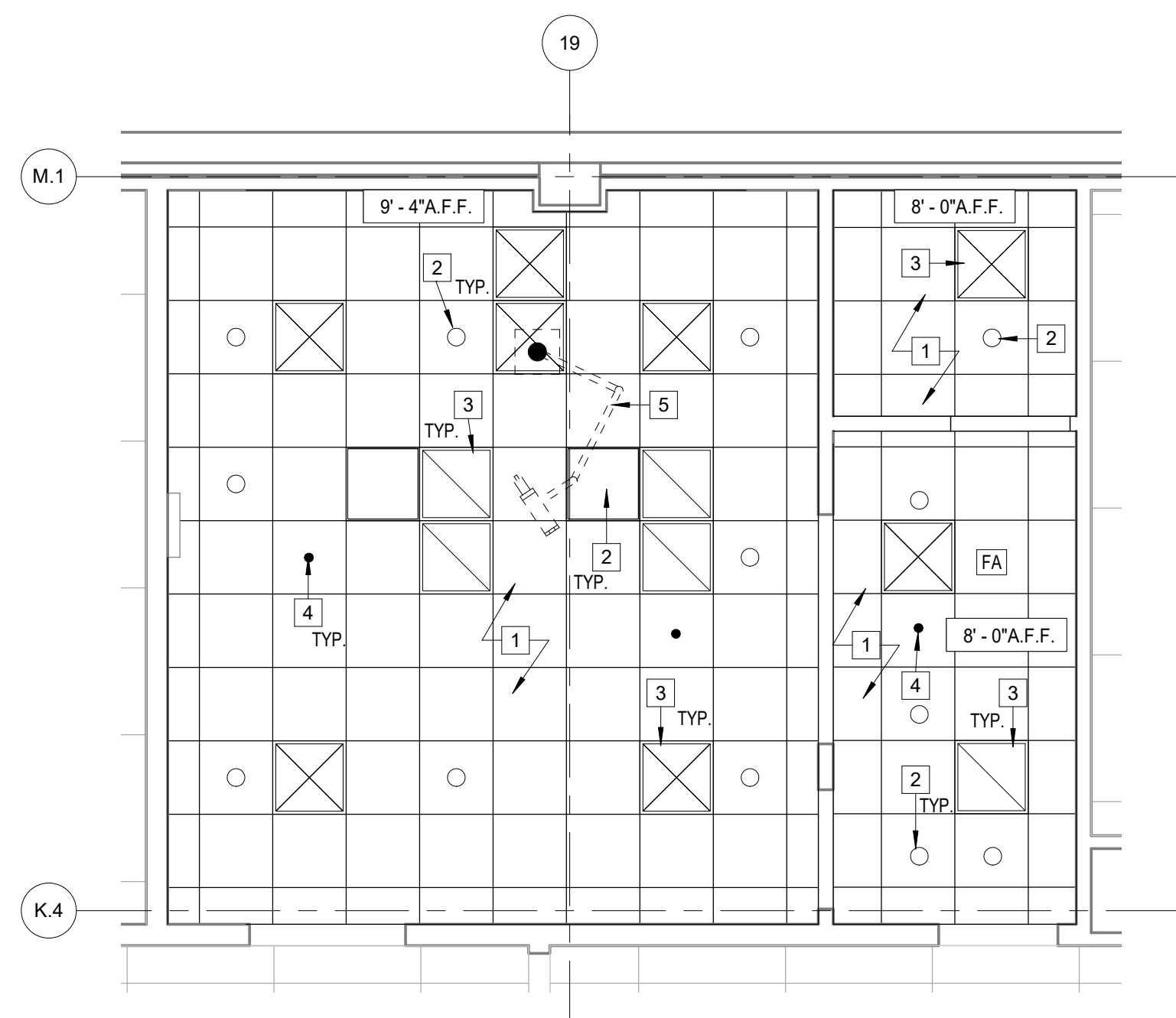

C1
A102
NEW REFLECTED CEILING PLAN (BASE BID) - CT EXAM 1314A
1/4" = 1'-0"

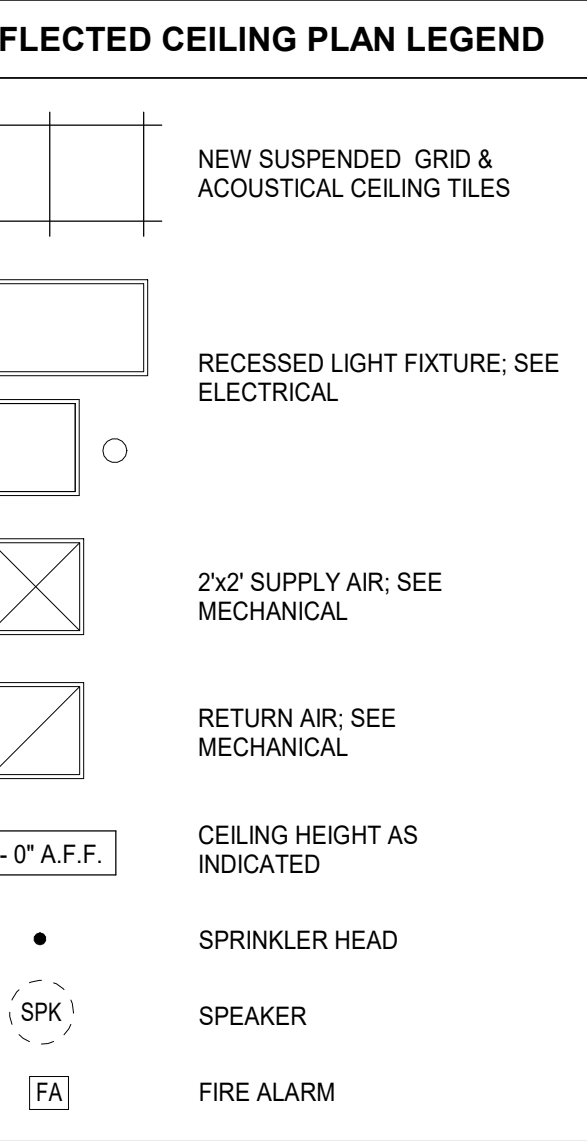

- REFLECTED CEILING PLAN NOTES**
- 1 NEW SUSPENDED ACOUSTICAL CEILING & GRID (ACP-1, SEE SPECIFICATION)
 - 2 NEW LIGHT FIXTURE, SEE ELECTRICAL
 - 3 NEW HVAC GRILLE, SEE MECHANICAL
 - 4 SPRINKLER HEAD
 - 5 REINSTALL INJECTOR

- GENERAL NOTES**
1. REINSTALL CEILING DEVICES AND RECONNECT TO EXISTING CIRCUITS UPON COMPLETION OF CEILING INSTALLATION.

Architects Alaska
ARCHITECTS ALASKA
AK Corp. Authorization AECC561
900 W. 5th Avenue, Suite 403
Anchorage, Alaska 99501-2029
907.272.3567 907.277.1732 fax
191 E. Swanson Avenue, Suite 203
Wasilla, Alaska 99564-7025
907.373.7503 907.376.3166 fax
347 S. Ferguson Ave, Suite 3
Bozeman, Montana 59715
406.404.1588
www.architectsalaska.com

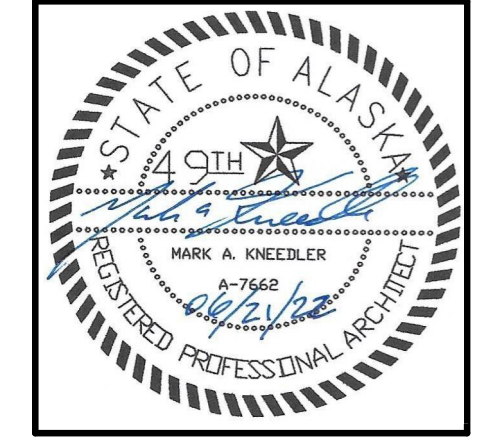

City and Borough of Juneau
BARTLETT REGIONAL HOSPITAL MRI & CT REPLACEMENT
3260 Hospital Dr. Juneau, AK 99801

Revisions

No.	Description	Date

Drawn by ARB	Date 06-17-2022
Checked MAK	Job No. 22008.01

Sheet Contents
NEW PLAN - CT 1314A

Sheet No.
A102

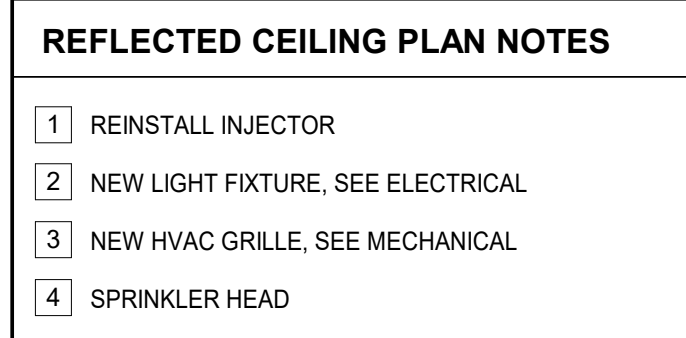
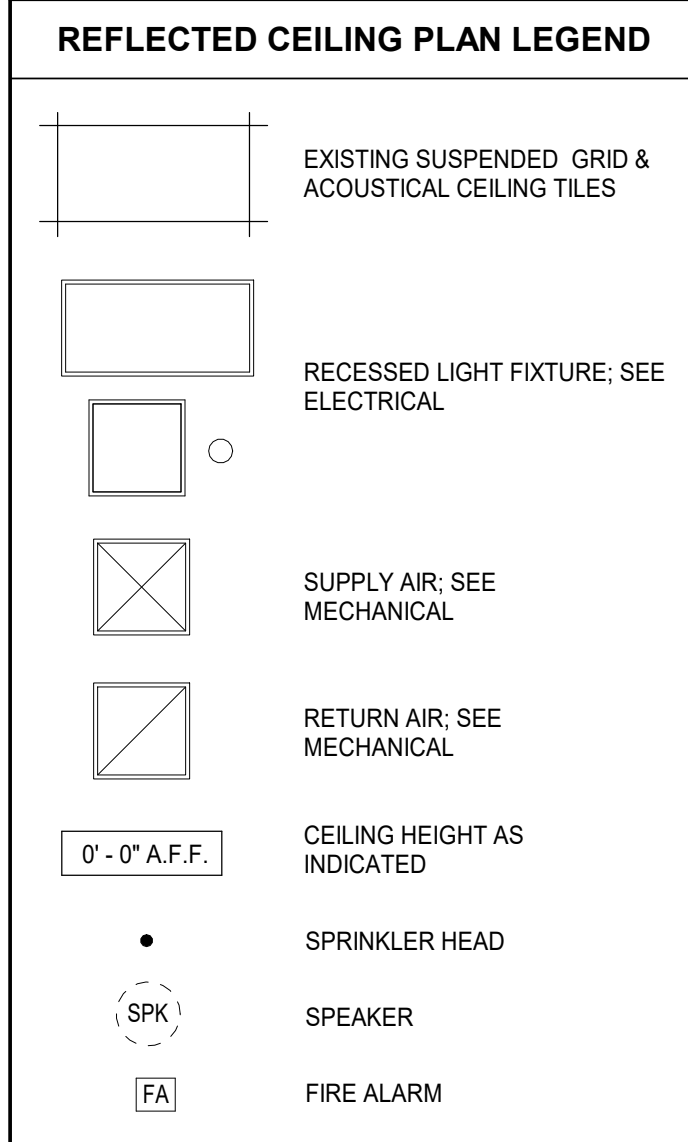
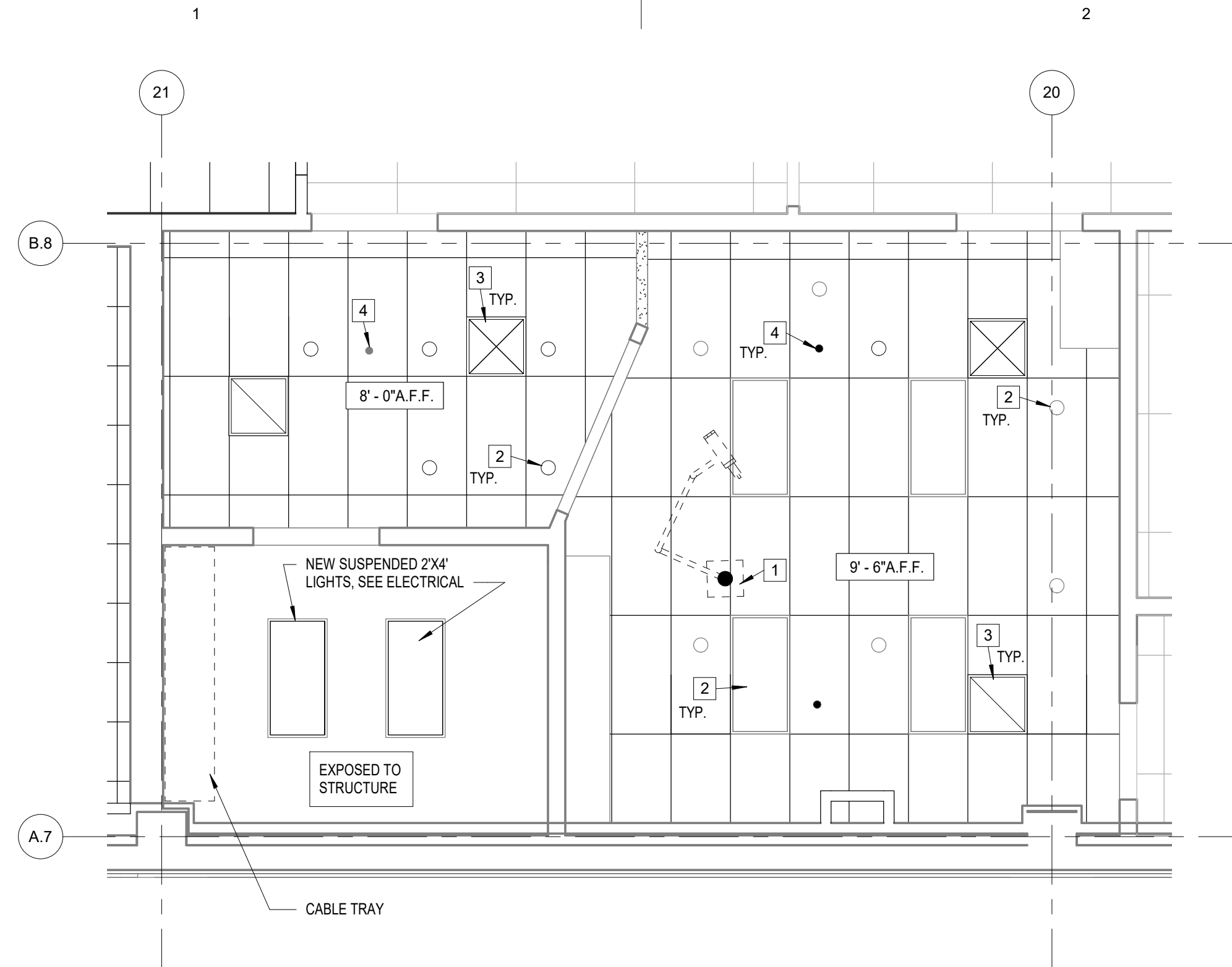

C1
A103
NEW REFLECTED CEILING PLAN - CT EXAM 1361
1/4" = 1'-0"

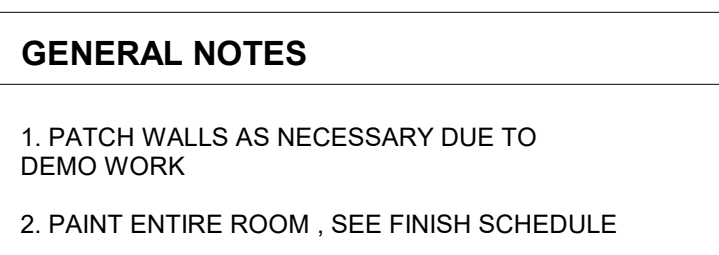
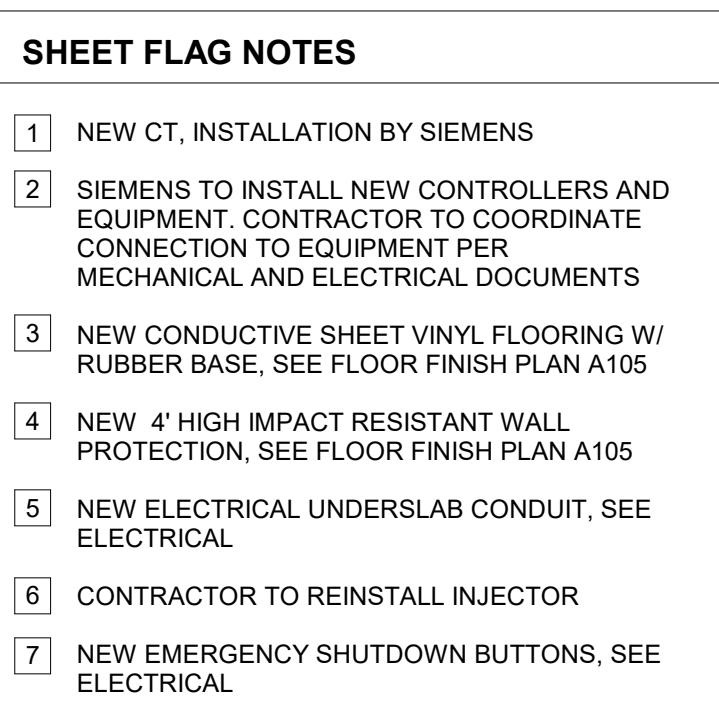
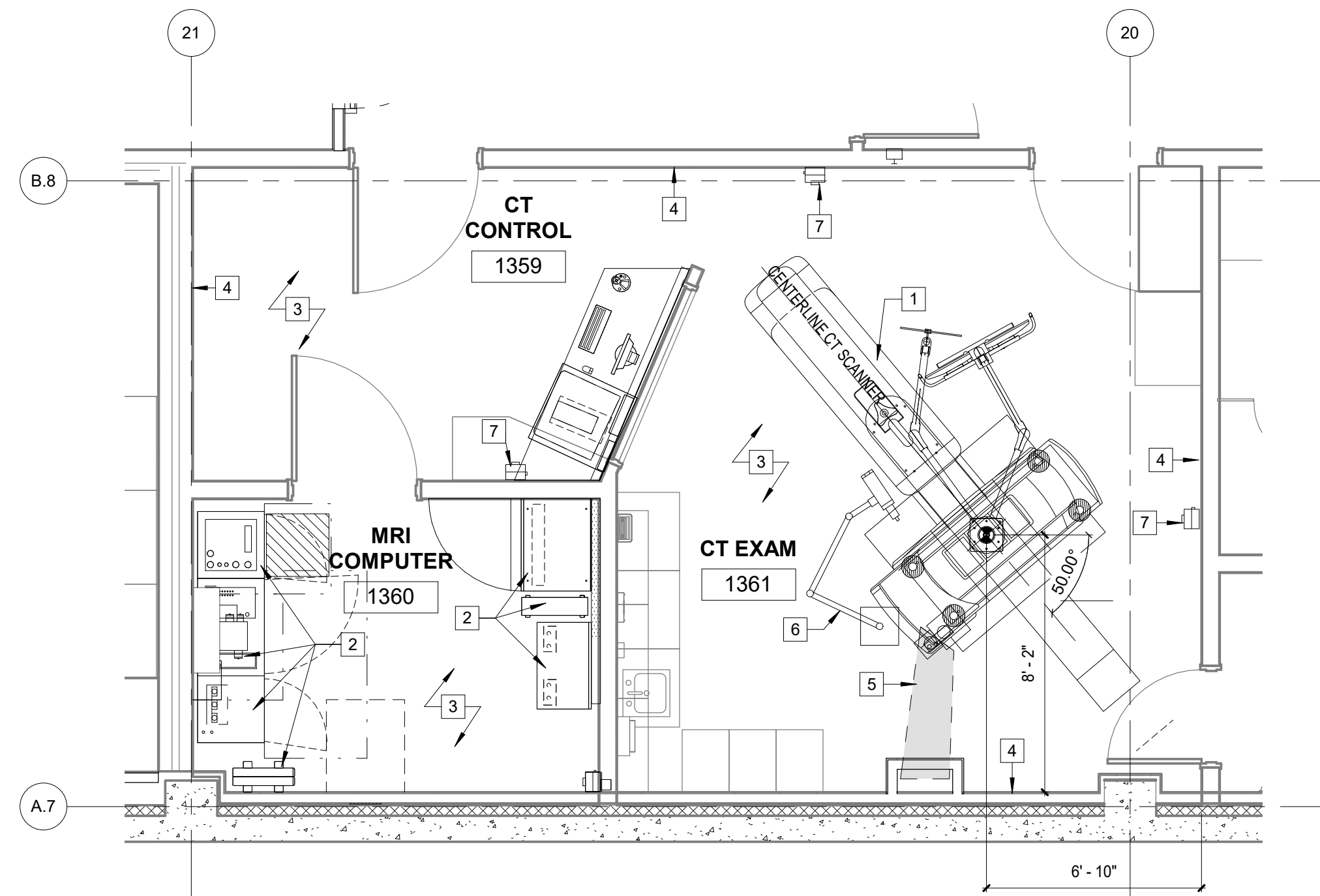
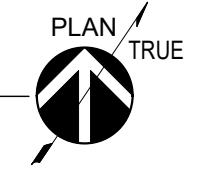

A1
A103
NEW PLAN - CT EXAM 1361
1/4" = 1'-0"

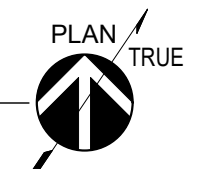

Architects Alaska
ARCHITECTS ALASKA
AK Corp. Authorization AECC561
900 W. 5th Avenue, Suite 403
Anchorage, Alaska 99501-2029
907.272.3567 907.277.1732 fax
191 E. Swanson Avenue, Suite 203
Wasilla, Alaska 99564-7025
907.373.7503 907.376.3166 fax
347 S. Ferguson Ave, Suite 3
Bozeman, Montana 59715
406.404.1588
www.architectsalaska.com



City and Borough of Juneau
BARTLETT REGIONAL HOSPITAL MRI & CT REPLACEMENT
3260 Hospital Dr. Juneau, AK 99801

Revisions

No.	Description	Date

Drawn by ARB	Date 06-17-2022
Checked MAK	Job No. 22008.01

Sheet Contents
NEW PLAN - CT 1361

Sheet No.
A103

BIM 360/1/21090.01 BRH Emergency Dept Add & Reno/21090.01 BRH ED Add & Reno.rvt
Plot Date Time: 6/21/2022 5:10:00 PM

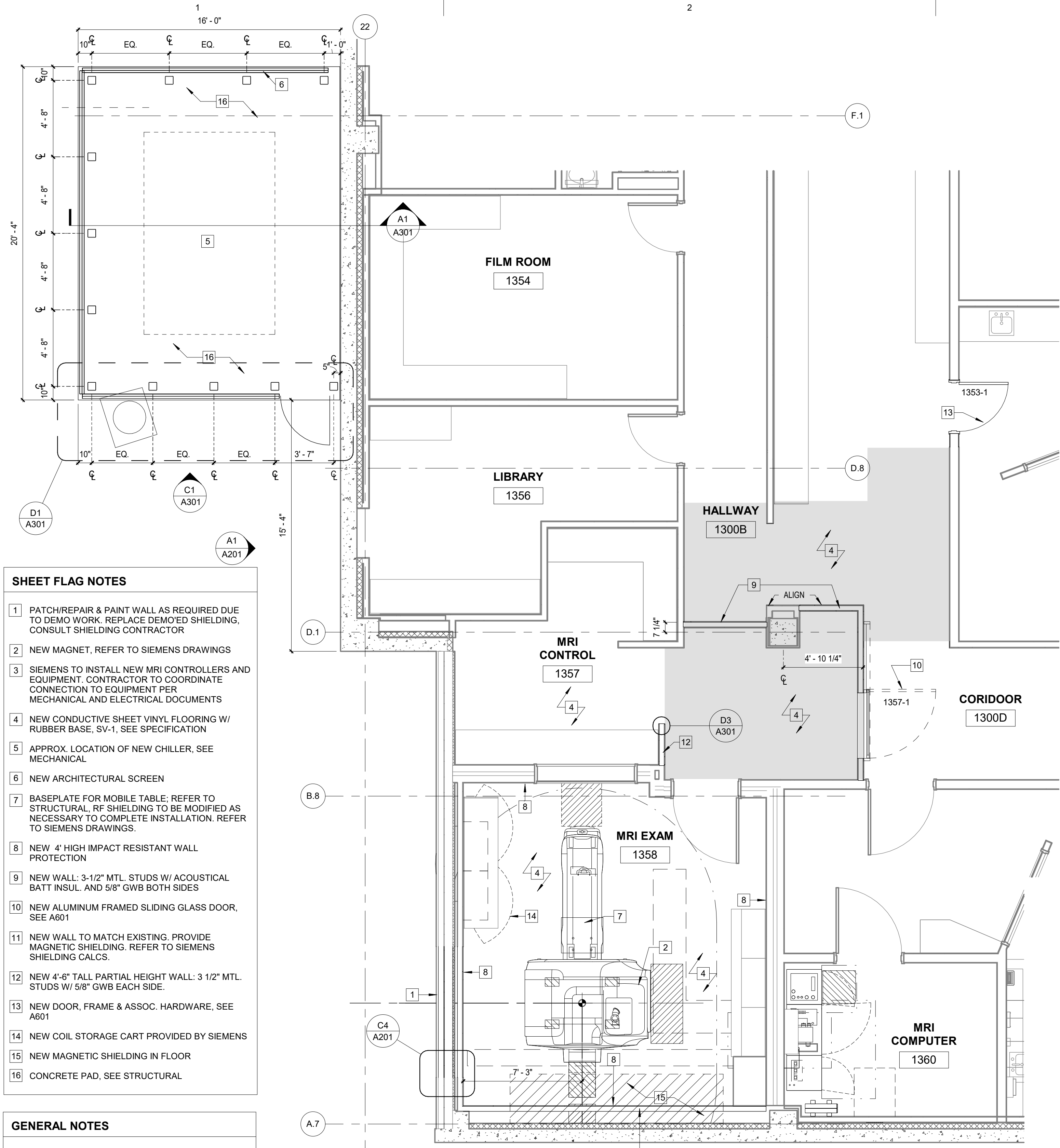

SHEET FLAG NOTES

- 1 PATCH/REPAIR & PAINT WALL AS REQUIRED DUE TO DEMO WORK. REPLACE DEMO'ED SHIELDING. CONSULT SHIELDING CONTRACTOR
- 2 NEW MAGNET, REFER TO SIEMENS DRAWINGS
- 3 SIEMENS TO INSTALL NEW MRI CONTROLLERS AND EQUIPMENT. CONTRACTOR TO COORDINATE CONNECTION TO EQUIPMENT PER MECHANICAL AND ELECTRICAL DOCUMENTS
- 4 NEW CONDUCTIVE SHEET VINYL FLOORING W/ RUBBER BASE, SV-1, SEE SPECIFICATION
- 5 APPROX. LOCATION OF NEW CHILLER, SEE MECHANICAL
- 6 NEW ARCHITECTURAL SCREEN
- 7 BASEPLATE FOR MOBILE TABLE: REFER TO STRUCTURAL. RF SHIELDING TO BE MODIFIED AS NECESSARY TO COMPLETE INSTALLATION. REFER TO SIEMENS DRAWINGS.
- 8 NEW 4' HIGH IMPACT RESISTANT WALL PROTECTION
- 9 NEW WALL: 3-1/2" MTL. STUDS W/ ACOUSTICAL BATT INSUL. AND 5/8" GWB BOTH SIDES
- 10 NEW ALUMINUM FRAMED SLIDING GLASS DOOR, SEE A601
- 11 NEW WALL TO MATCH EXISTING. PROVIDE MAGNETIC SHIELDING. REFER TO SIEMENS SHIELDING CALCS.
- 12 NEW 4'-6" TALL PARTIAL HEIGHT WALL: 3 1/2" MTL. STUDS W/ 5/8" GWB EACH SIDE.
- 13 NEW DOOR, FRAME & ASSOC. HARDWARE, SEE A601
- 14 NEW COIL STORAGE CART PROVIDED BY SIEMENS
- 15 NEW MAGNETIC SHIELDING IN FLOOR
- 16 CONCRETE PAD, SEE STRUCTURAL

GENERAL NOTES

1. ADDITIONAL MAGNETIC SHIELDING REQUIRED AT PLAN SOUTH MRI WALL AND FLOOR AND REPLACEMENT OF SHIELDING @ REMOVABLE WALL. COORDINATE WITH SHIELDING CONTRACTOR. REFERENCE SIEMENS MRI SHIELDING REPORT FOR SPECIFICATIONS. CONTRACTOR TO PROVIDE SHIELDING IN COMPLIANCE WITH REPORT DATED...
2. EXISTING CASEWORK TO REMAIN AS IS U.N.O.

A1
A104
NEW PLAN - MRI EXAM 1358
1/4" = 1'-0"

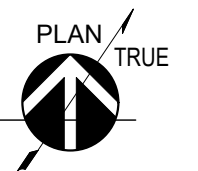

- REFLECTED CEILING PLAN NOTES**
- 1 NEW SUSPENDED ACOUSTICAL CEILING & GRID. MRI CEILING GRID TO BE ALUMINUM NON-FERROMAGNETIC.
 - 2 NEW LIGHT FIXTURE, SEE ELECTRICAL
 - 3 NEW HVAC GRILLE, SEE MECHANICAL
 - 4 CABLE TRAY ABOVE CEILING, SEE ELECTRICAL

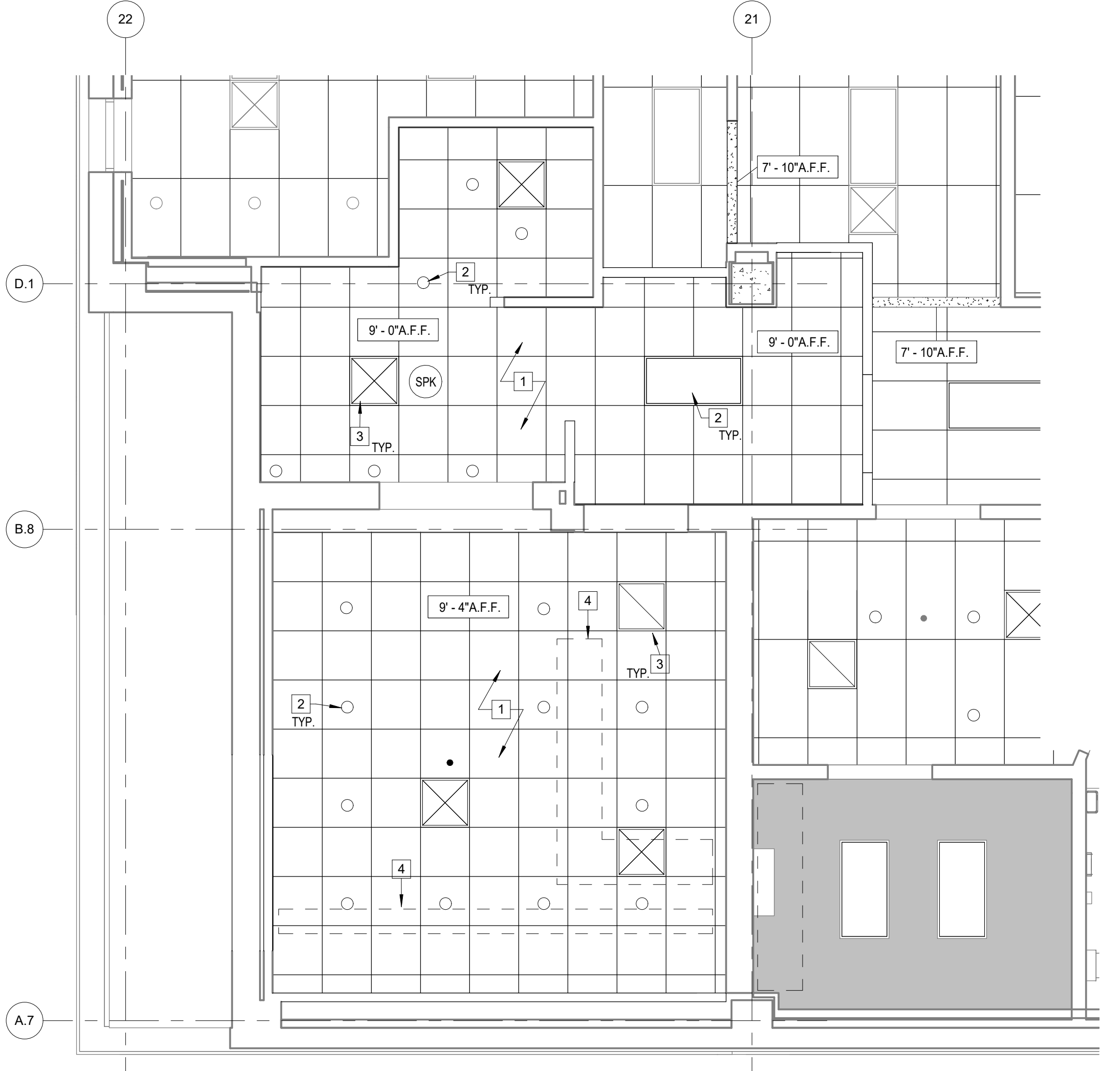
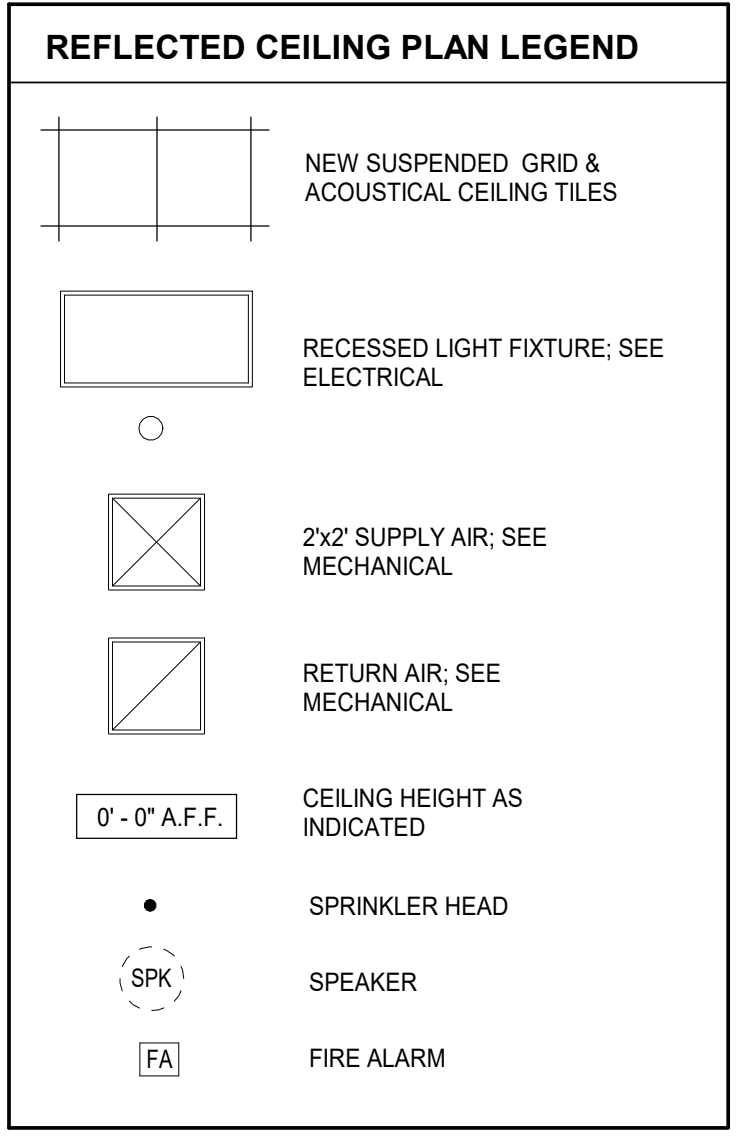

A3
A104
NEW REFLECTED CEILING PLAN - MRI EXAM 1358
1/4" = 1'-0"

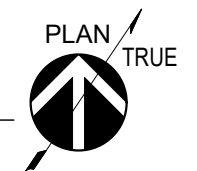

Architects Alaska.
ARCHITECTS ALASKA
AK Corp. Authorization AECC561
900 W. 5th Avenue, Suite 403
Anchorage, Alaska 99501-2029
907.272.3567 907.277.1732 fax
191 E. Swanson Avenue, Suite 203
Wasilla, Alaska 99564-7025
907.373.7503 907.376.3166 fax
347 S. Ferguson Ave, Suite 3
Bozeman, Montana 59715
406.404.1588
www.architectsalaska.com

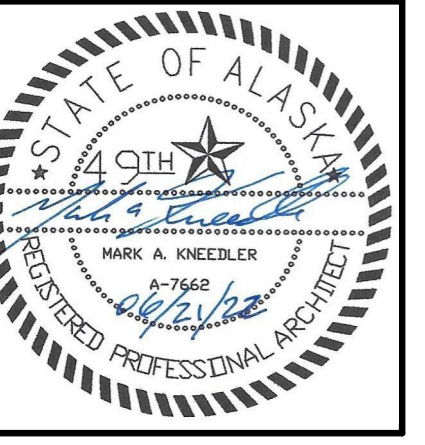

City and Borough of Juneau
BARTLETT REGIONAL HOSPITAL MRI & CT REPLACEMENT
3260 Hospital Dr. Juneau, AK 99801

Revisions

No.	Description	Date

Drawn by ARB	Date 06-17-2022
Checked MAK	Job No. 22008.01

Sheet Contents
NEW PLAN - MRI 1358

Sheet No.
A104

BIM 360://21090.01 BRH Emergency Dept Add & Reno/21090.01 BRH ED Add & Reno.rvt

C1
A301

Plot Date Time: 6/21/2022 5:10:01 PM

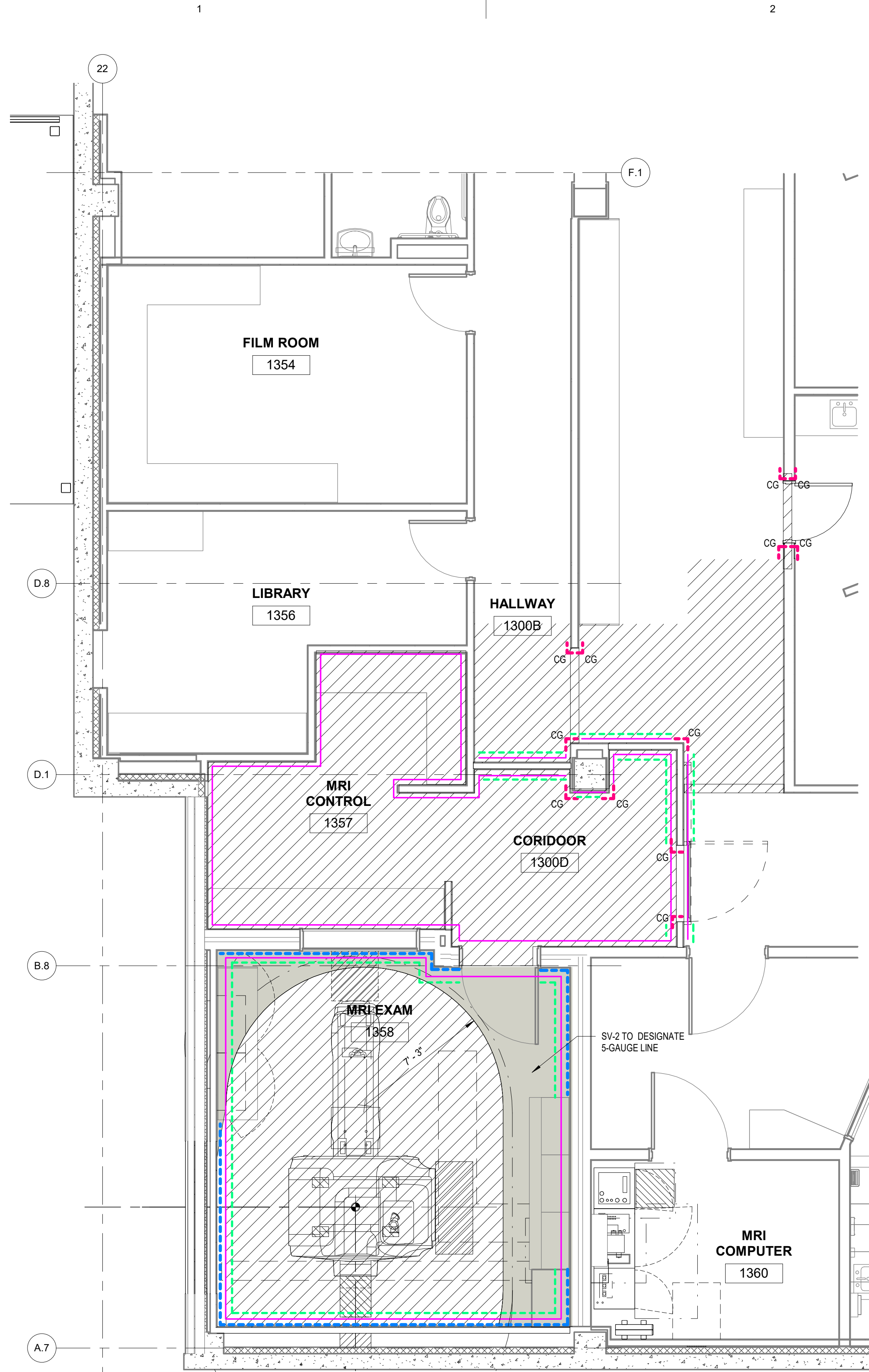

A1 FLOOR FINISH PLAN - MRI EXAM 1358
A105 1/4" = 1'-0"

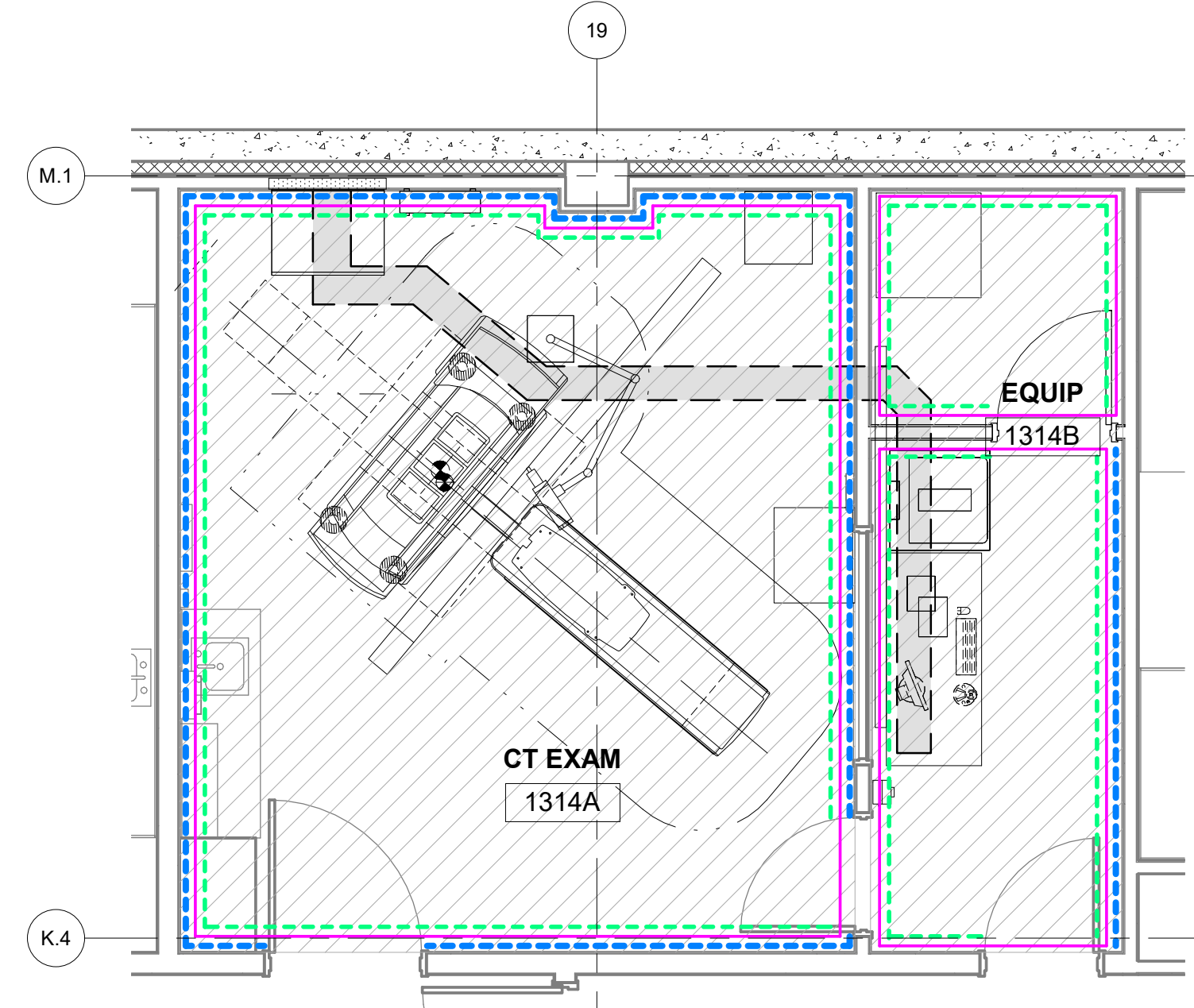



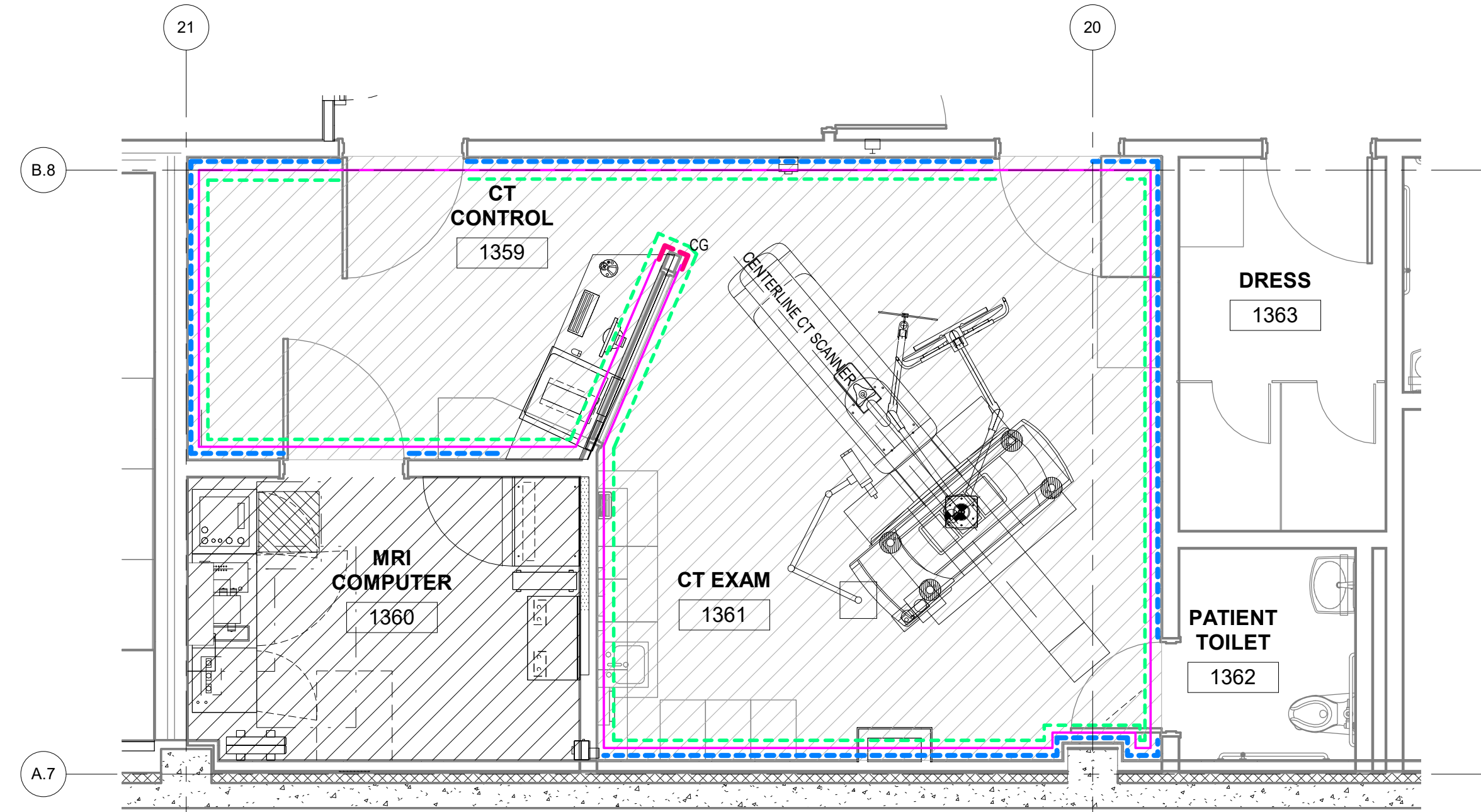

B2 FLOOR FINISH PLAN - CT EXAM 1314A
A105 1/4" = 1'-0"

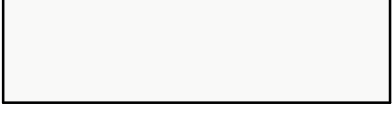

A3 FLOOR FINISH PLAN - CT EXAM 1361
A105 1/4" = 1'-0"

SHEET LEGEND

	RSF-1 (REFER TO SPECIFICATIONS)
	RSF-2 (REFER TO SPECIFICATIONS)
	IRP-1 - 4' HIGH WALL PROTECTION INSTALLED ABOVE RUBBER BASE (REFER TO SPECIFICATIONS)
	RB-1 (REFER TO SPECIFICATIONS)
	PT-1 (REFER TO SPECIFICATIONS)
	CG-1 - 4' HIGH STAINLESS STEEL CORNER GUARDS (REFER TO SPECIFICATIONS)

**Architects
Alaska.**

ARCHITECTS ALASKA
AK Corp. Authorization AECC561
900 W. 5th Avenue, Suite 403
Anchorage, Alaska 99501-2029
907.272.3567 907.277.1732 fax

191 E. Swanson Avenue, Suite 203
Wasilla, Alaska 99564-7025
907.373.7503 907.376.3166 fax
347 S. Ferguson Ave, Suite 3
Bozeman, Montana 59715
406.404.1588
www.architectsalaska.com

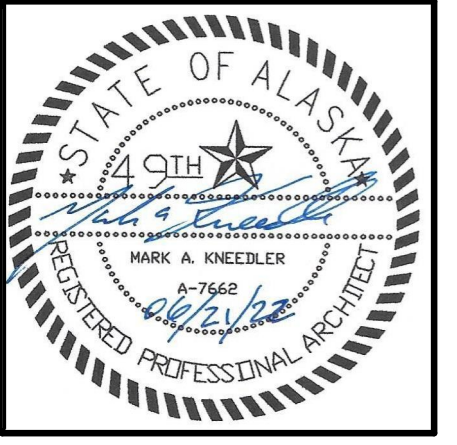

City and Borough of Juneau
**BARTLETT REGIONAL HOSPITAL MRI
& CT REPLACEMENT**
 3260 Hospital Dr. Juneau, AK 99801

Revisions		
No.	Description	Date

Drawn by Author	Date 06-17-2022
Checked Checker	Job No. 22008.01

Sheet Contents
FLOOR FINISH PLAN

Sheet No.
A105

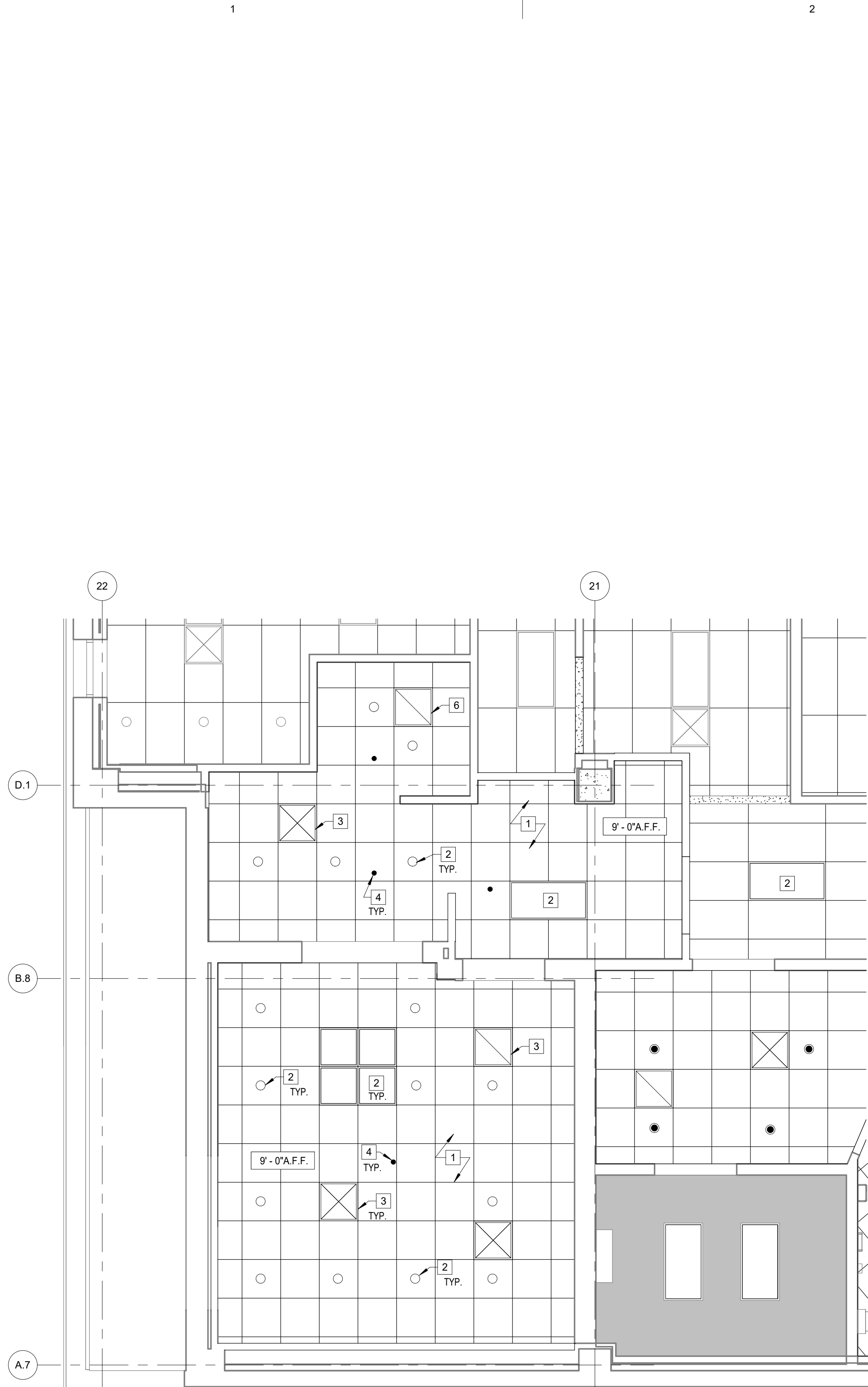

A1 NEW REFLECTED CEILING PLAN (ALTERNATE 1) - MRI EXAM 1358
A106 1/4" = 1'-0"

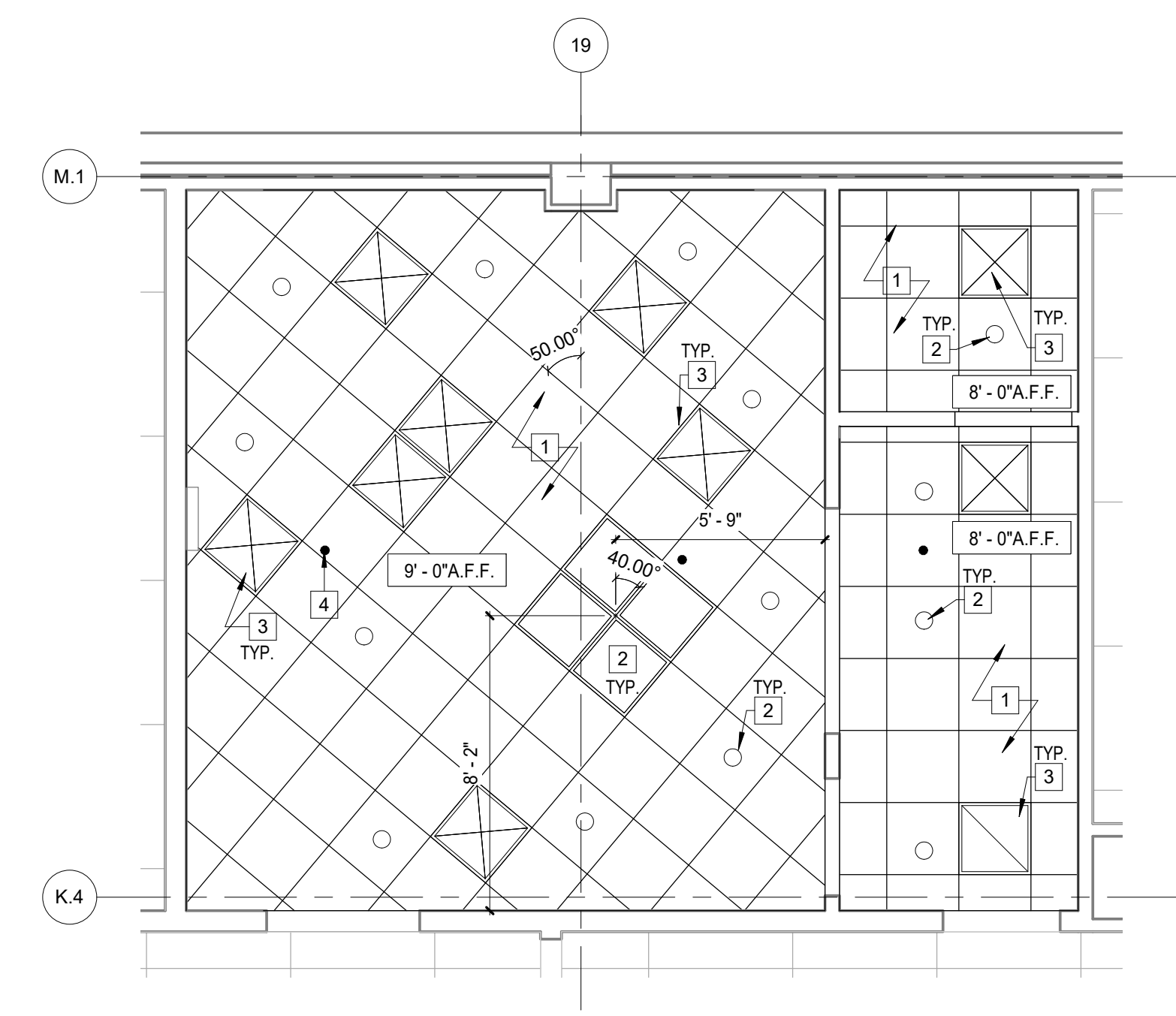

C3 NEW REFLECTED CEILING PLAN (ALTERNATE 1) - CT EXAM 1314A
A106 1/4" = 1'-0"

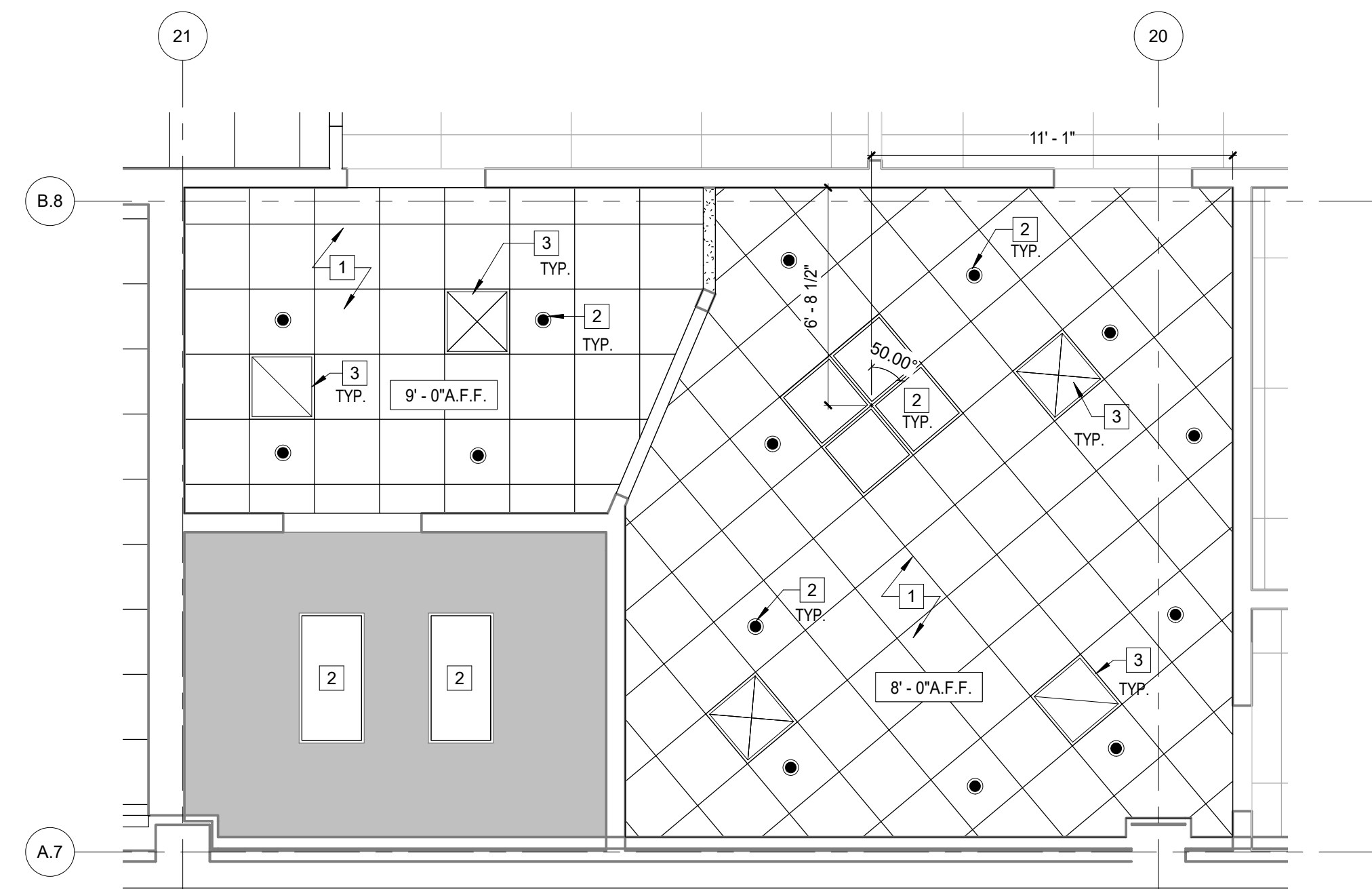

A3 NEW REFLECTED CEILING PLAN (ALTERNATE 1) - CT EXAM 1361
A106 1/4" = 1'-0"

REFLECTED CEILING PLAN LEGEND

- 2x4 SUSPENDED ACOUSTICAL CEILING TO REMAIN
- 2x2 SUSPENDED ACOUSTICAL CEILING, ACP-1, SEE SPECIFICATIONS
- RECESSED 2x2 DECORATIVE LENS LIGHT FIXTURE, SEE ELECTRICAL
- RECESSED LIGHT FIXTURE; SEE ELECTRICAL
- 2x2 SUPPLY AIR; SEE MECHANICAL
- 2x2 RETURN AIR; SEE MECHANICAL
- EXHAUST FAN; SEE MECHANICAL
- CEILING HEIGHT AS INDICATED

REFLECTED CEILING PLAN NOTES

- 1 NEW 2x2 SUSPENDED ACOUSTICAL CEILING & GRID
- 2 NEW LIGHT FIXTURE, SEE ELECTRICAL
- 3 NEW HAVC GRILLE, SEE MECHANICAL
- 4 SPRINKLER HEAD

GENERAL NOTES

1. REMOVE CEILING MOUNTED DEVICES TO ACCOMMODATE REPLACEMENT OF CEILING TILES & GRID. REINSTALL CEILING DEVICES AND RECONNECT TO EXISTING CIRCUITS UPON COMPLETION OF CEILING INSTALLATION.

Architects Alaska
ARCHITECTS ALASKA
 AK Corp. Authorization AECC661
 900 W. 5th Avenue, Suite 403
 Anchorage, Alaska 99501-2029
 907.272.3567 907.277.1732 fax
 191 E. Swanson Avenue, Suite 203
 Wasilla, Alaska 99564-7025
 907.373.7503 907.376.3166 fax
 347 S. Ferguson Ave, Suite 3
 Bozeman, Montana 59715
 406.404.1588
 www.architectsalaska.com

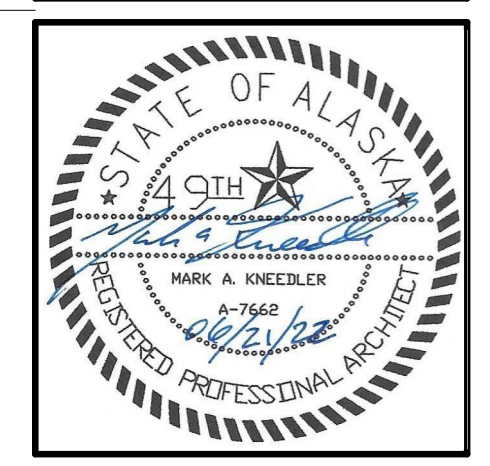

City and Borough of Juneau
BARTLETT REGIONAL HOSPITAL MRI & CT REPLACEMENT
 3260 Hospital Dr. Juneau, AK 99801

Revisions

No.	Description	Date

Drawn by Author	Date 06-17-2022
Checked Checker	Job No. 22008.01

Sheet Contents
 ALTERNATE RCP

Sheet No.
A106

BIM 360://21090.01 BRH Emergency Dept Add & Reno/21090.01 BRH ED Add & Reno.rvt

C

B

A

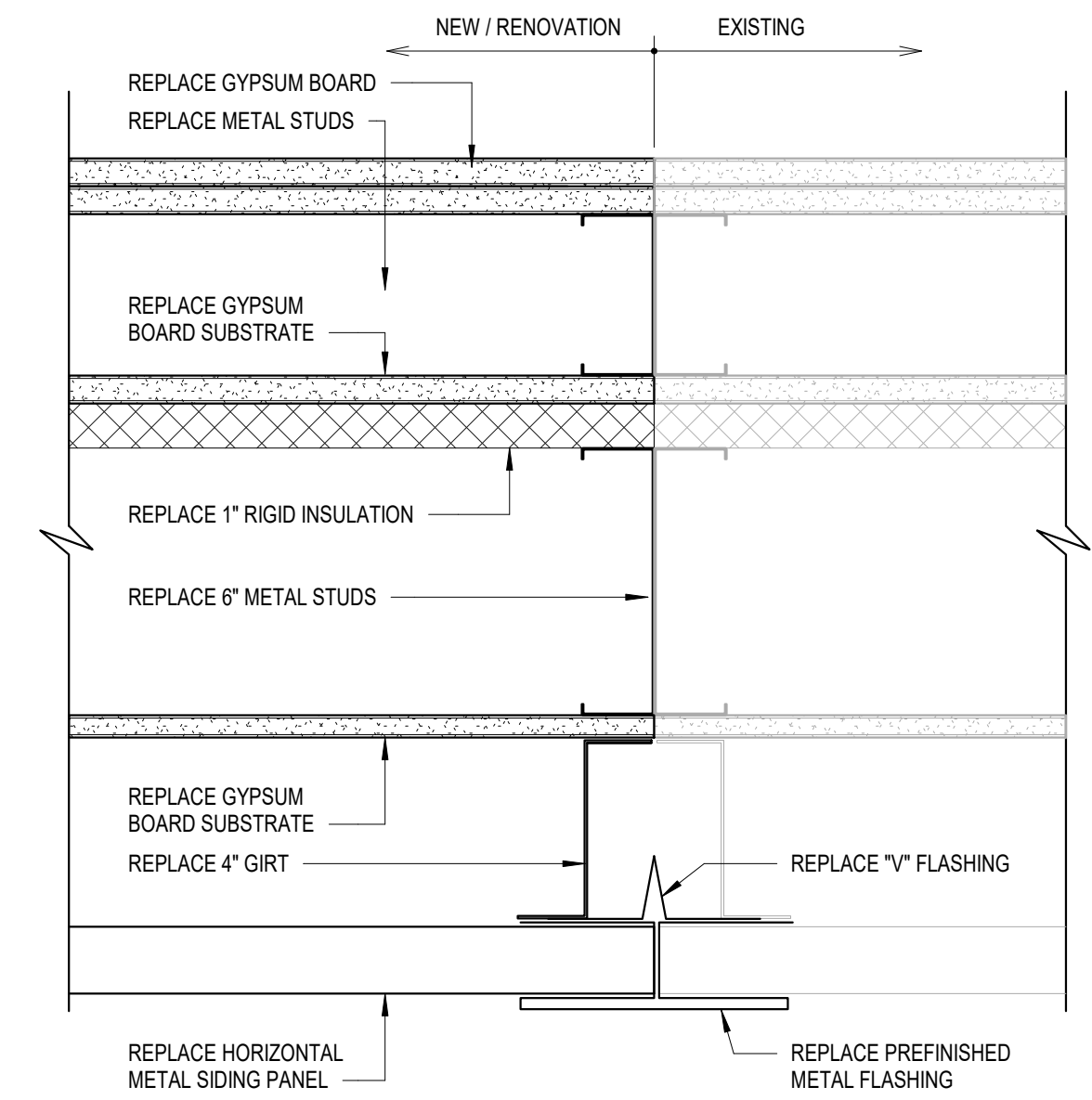
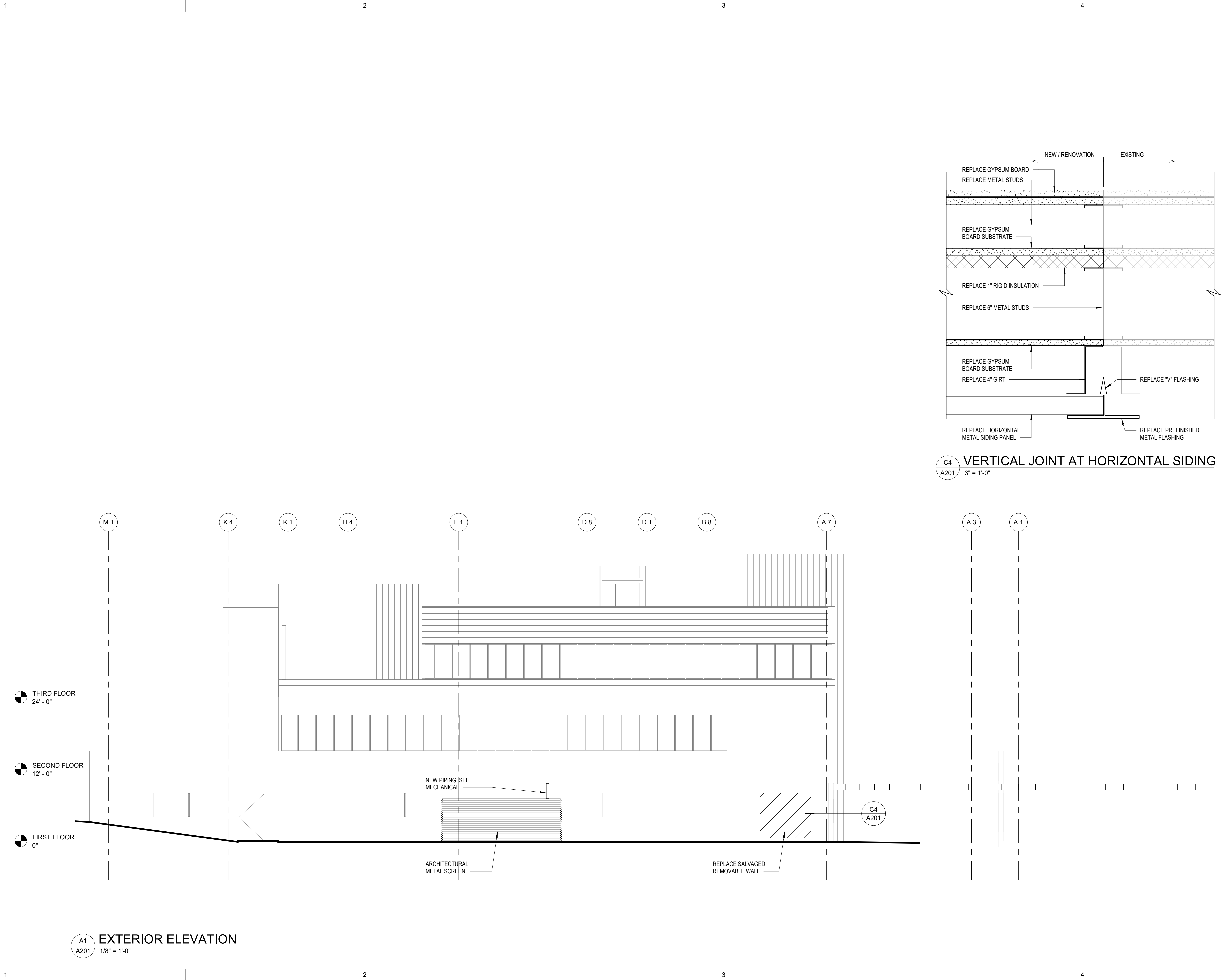

C4
A201 VERTICAL JOINT AT HORIZONTAL SIDING
3" = 1'-0"

A1
A201 EXTERIOR ELEVATION
1/8" = 1'-0"

Architects Alaska
 ARCHITECTS ALASKA
 AK Corp. Authorization AECC561
 900 W. 5th Avenue, Suite 403
 Anchorage, Alaska 99501-2029
 907.272.3567 907.277.1732 fax
 191 E. Swanson Avenue, Suite 203
 Wasilla, Alaska 99564-7025
 907.373.7503 907.376.3166 fax
 347 S. Ferguson Ave, Suite 3
 Bozeman, Montana 59715
 406.404.1588
 www.architectsalaska.com

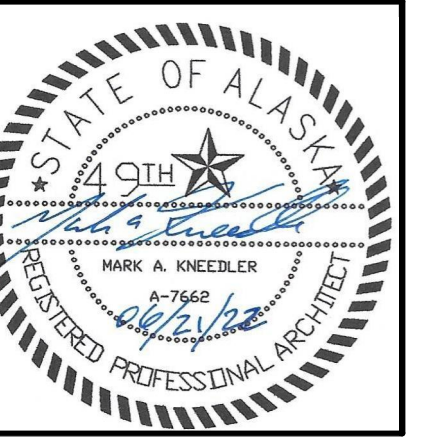

City and Borough of Juneau
**BARTLETT REGIONAL HOSPITAL MRI
 & CT REPLACEMENT**
 3260 Hospital Dr. Juneau, AK 99801

Revisions		
No.	Description	Date

Drawn by MIR	Date 06-17-2022
Checked MAK	Job No. 22008.01

Sheet Contents
 EXTERIOR ELEVATIONS

Sheet No.
A201

Plot Date Time: 6/21/2022 5:10:04 PM

BIM 360://21090.01 BRH Emergency Dept Add & Reno/21090.01 BRH ED Add & Reno.rvt
Plot Date Time: 6/21/2022 5:10:05 PM

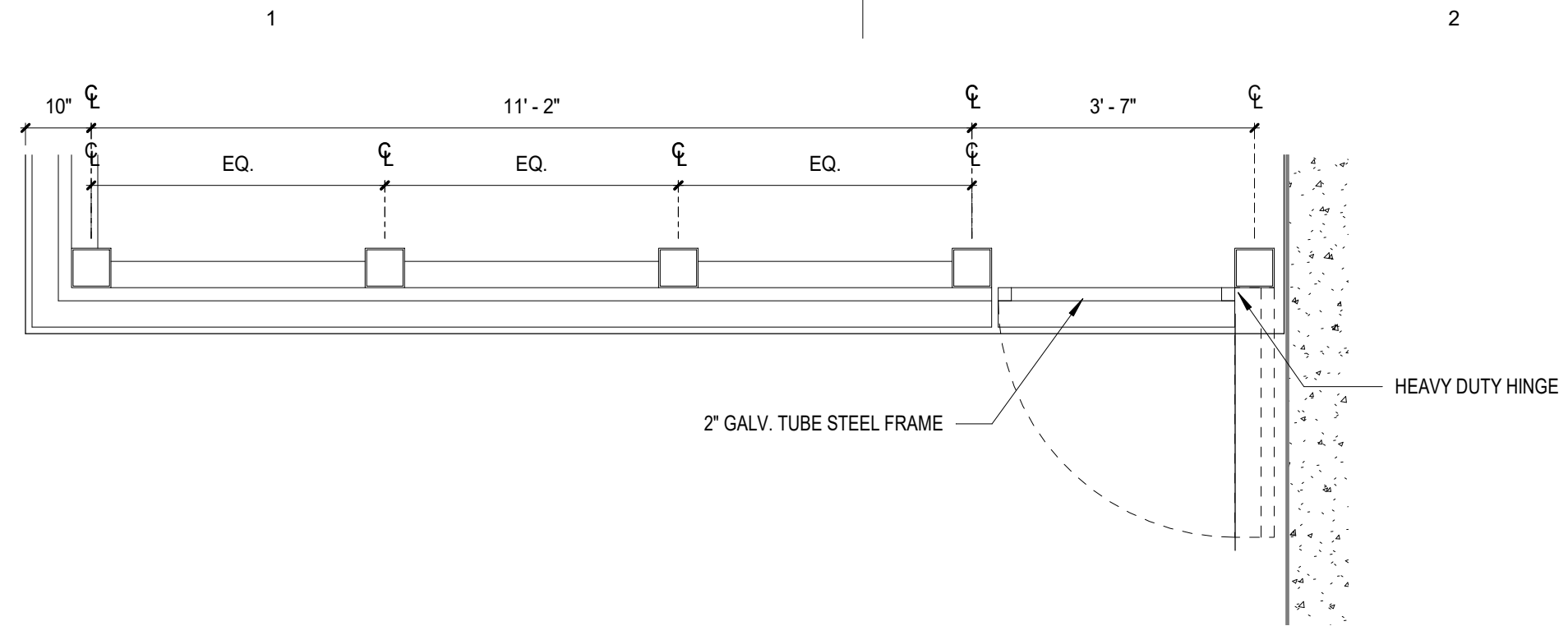

D1 ENLARGED FLOOR PLAN SCREEN WITH GATE
A301 1/2" = 1'-0"

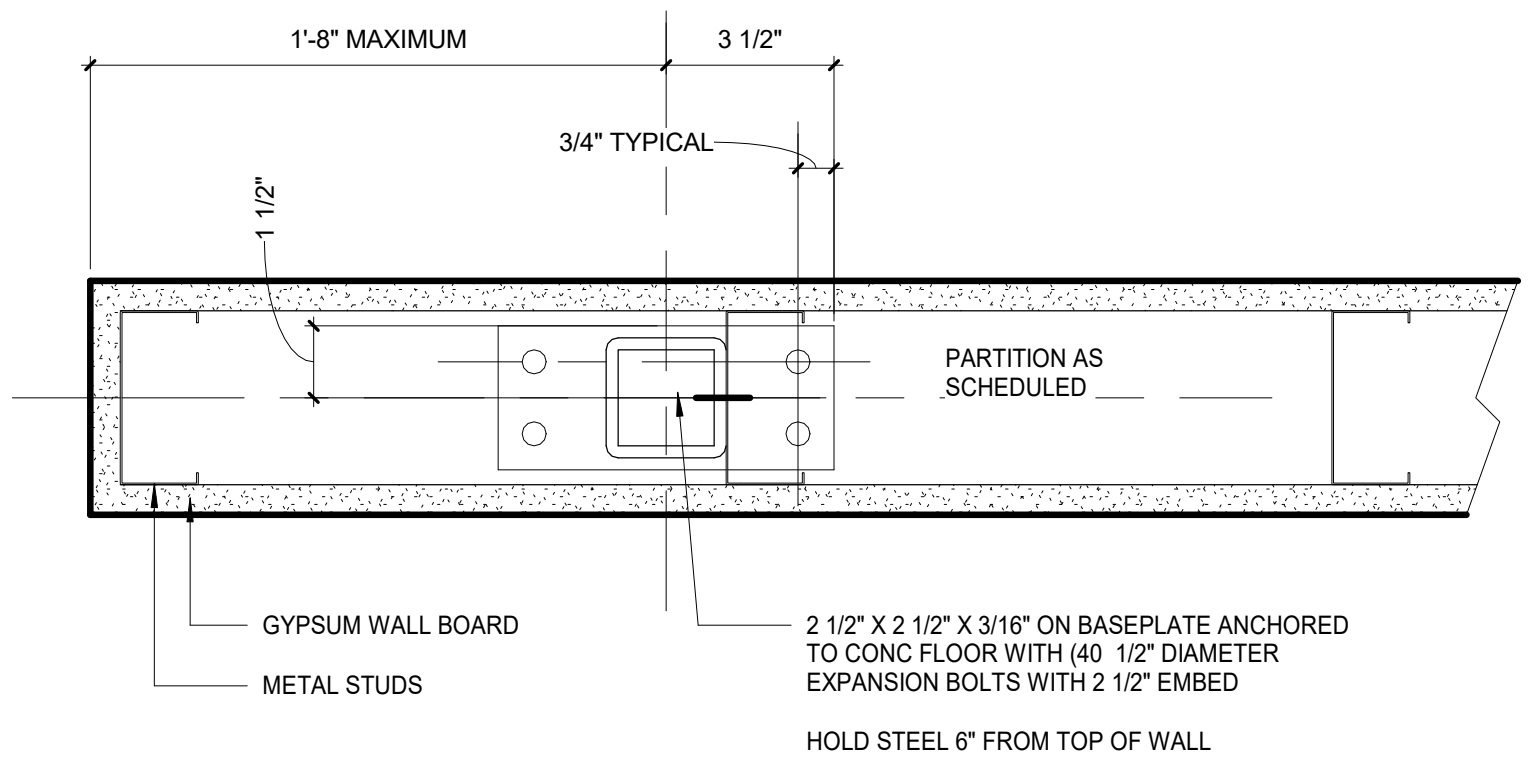

D3 PRTL HEIGHT WALL SUPPORT DETAIL
A301 3" = 1'-0"

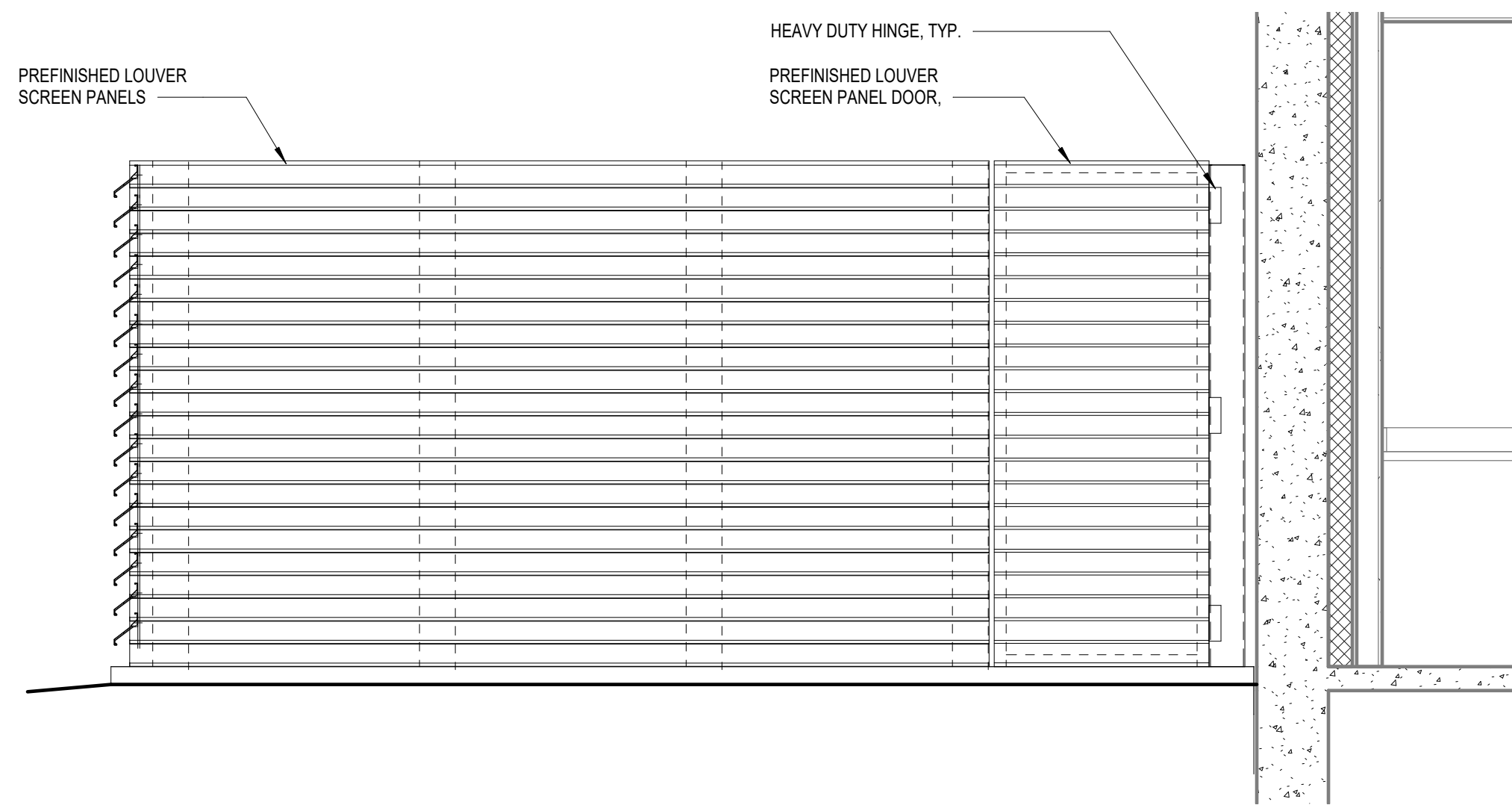

C1 ELEVATION VIEW SCREEN WITH GATE
A301 1/2" = 1'-0"

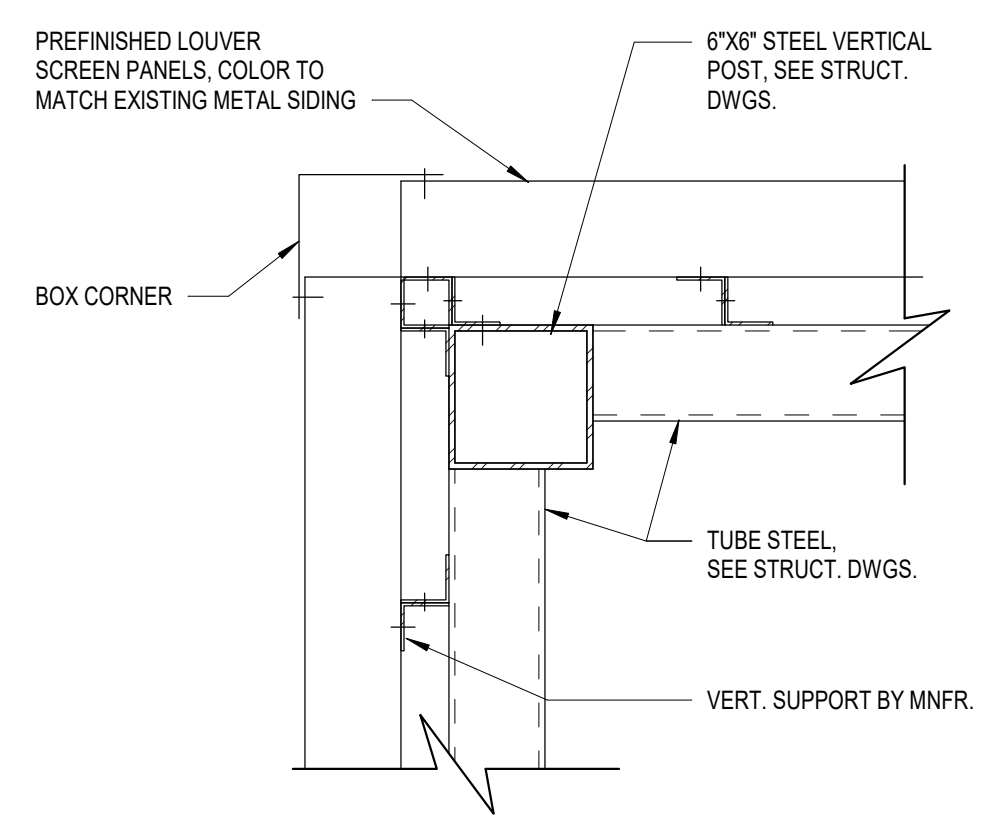

B3 SCREEN WALL PLAN CORNER DETAIL
A301 1 1/2" = 1'-0"

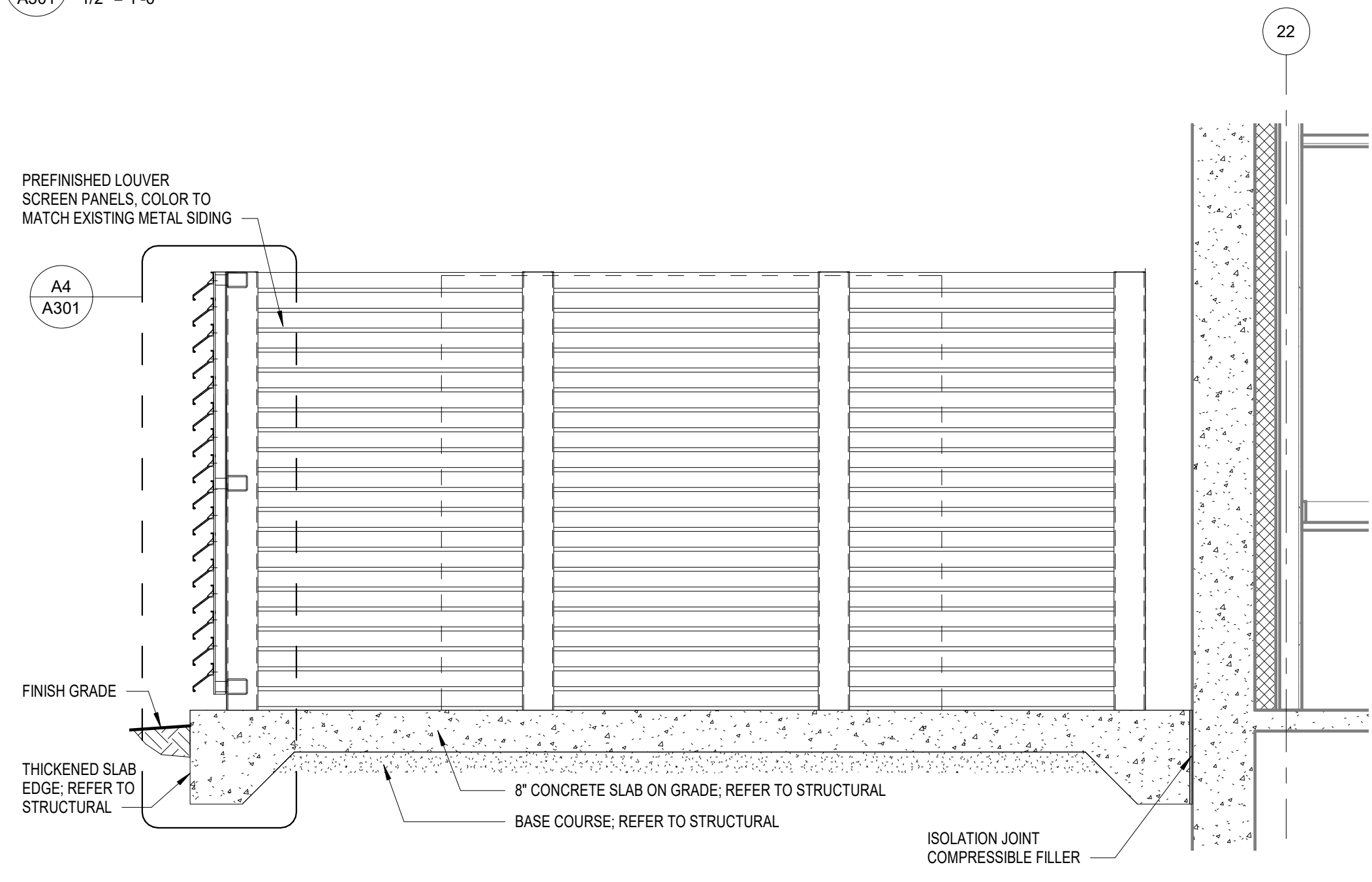

A1 SECTION AT CHILLER SCREEN
A301 1/2" = 1'-0"

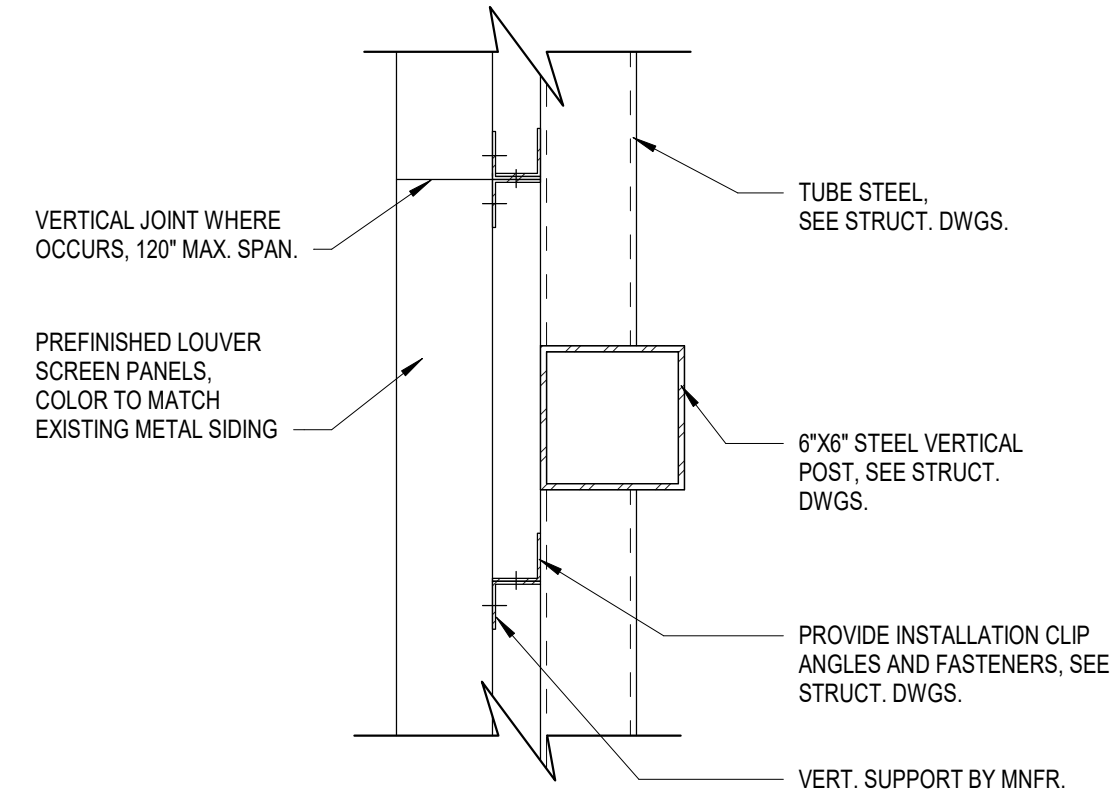

A3 SCREEN WALL PLAN JOINT DETAIL
A301 1 1/2" = 1'-0"

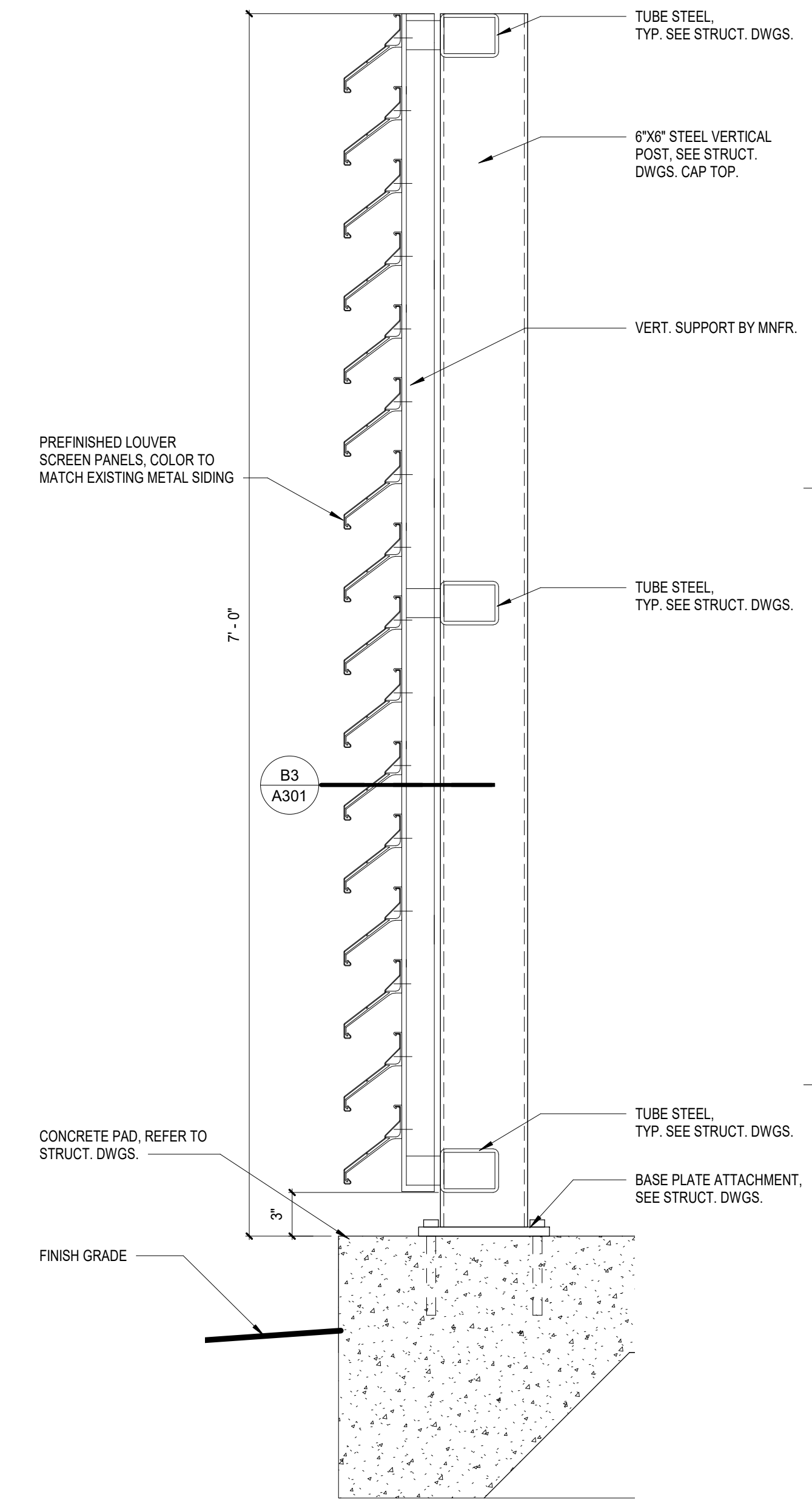

A4 SECTION AT CHILLER SCREEN DETAIL
A301 1 1/2" = 1'-0"

Architects Alaska
ARCHITECTS ALASKA
AK Corp. Authorization AECC561
900 W. 5th Avenue, Suite 403
Anchorage, Alaska 99501-2029
907.272.3567 907.277.1732 fax
191 E. Swanson Avenue, Suite 203
Wasilla, Alaska 99654-7025
907.373.7503 907.376.3166 fax
347 S. Ferguson Ave, Suite 3
Bozeman, Montana 59715
406.404.1588
www.architectsalaska.com

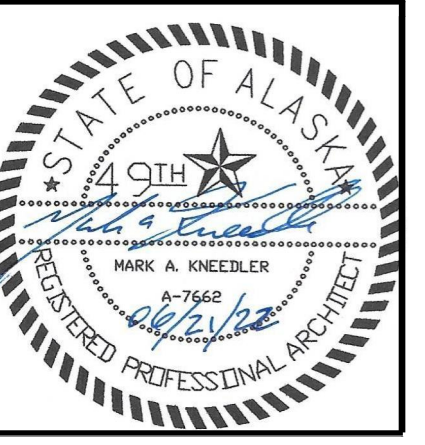

City and Borough of Juneau
BARTLETT REGIONAL HOSPITAL MRI & CT REPLACEMENT
3260 Hospital Dr. Juneau, AK 99801

Revisions		
No.	Description	Date

Drawn by MIR	Date 06-17-2022
Checked MAK	Job No. 22008.01

Sheet Contents
BUILDING SECTIONS

Sheet No.
A301

BIM 360://21090.01 BRH Emergency Dept Add & Reno/21090.01 BRH ED Add & Reno.rvt
Plot Date Time: 6/21/2022 5:10:05 PM

NO.	SIZE		DOOR				FRAME			HARDWARE GROUP	RATING	DETAILS			COMMENTS
	WIDTH	HEIGHT	TYPE	MATERIAL	FINISH	GLASS	TYPE	MATERIAL	FINISH			HEAD	JAMB	THRESHOLD	
1314B-1	3'-0"	7'-0"	1	WD	FF		1	HM	PT	HW-1		A1/A601	A1/A601		NEW
1353-1	3'-0"	7'-0"	1	WD	FF		1			HW-1	20 MIN	A1/A601	A1/A601		NEW
1357-1	4'-0"	7'-0"	3	ALUM	FF	TEMP				HW-3		B4/A601	A4/A601	B4/A601	NEW

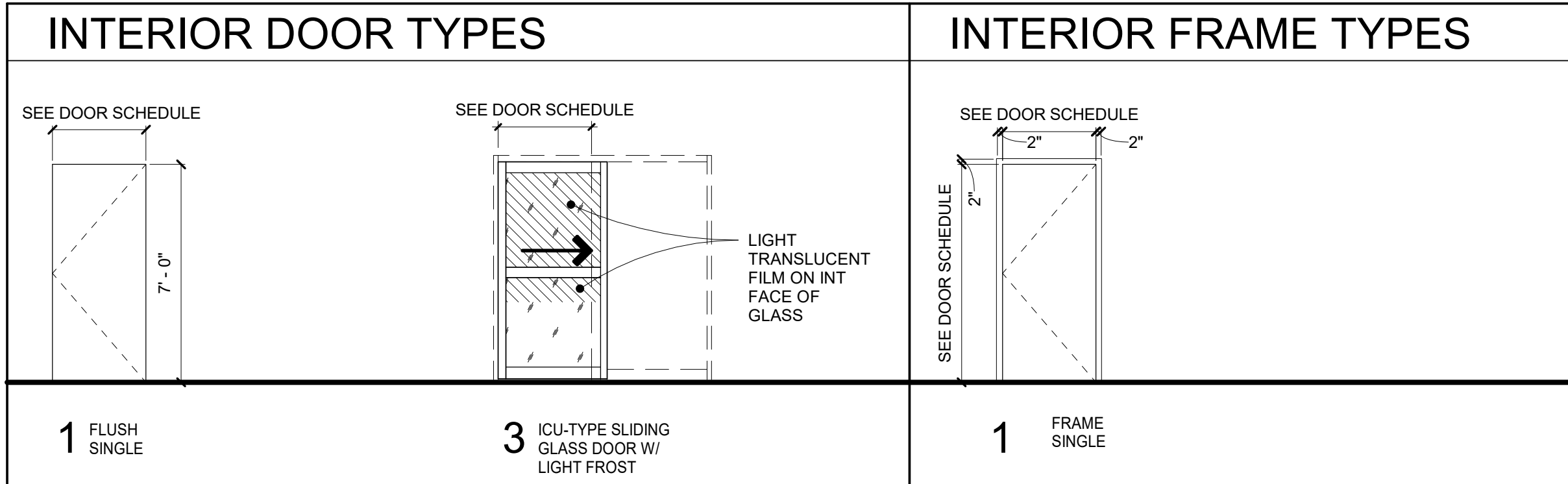

HARDWARE GROUPS	
HW-1	INTERIOR DOOR - ANSI FUNCTION F01 - PASSAGE SET
1 EA	DOOR STOP
3 EA	HINGES
1 EA	PASSAGE SET
1 SET	SMOKE GASKETING
1 SET	DOOR HANDLE
HW-3	INTERIOR DOOR - ICU STYLE SLIDING GLASS DOOR W/ ACCESS CONTROL
SEE SPECIFICATION FOR HARDWARE SCHEDULE	

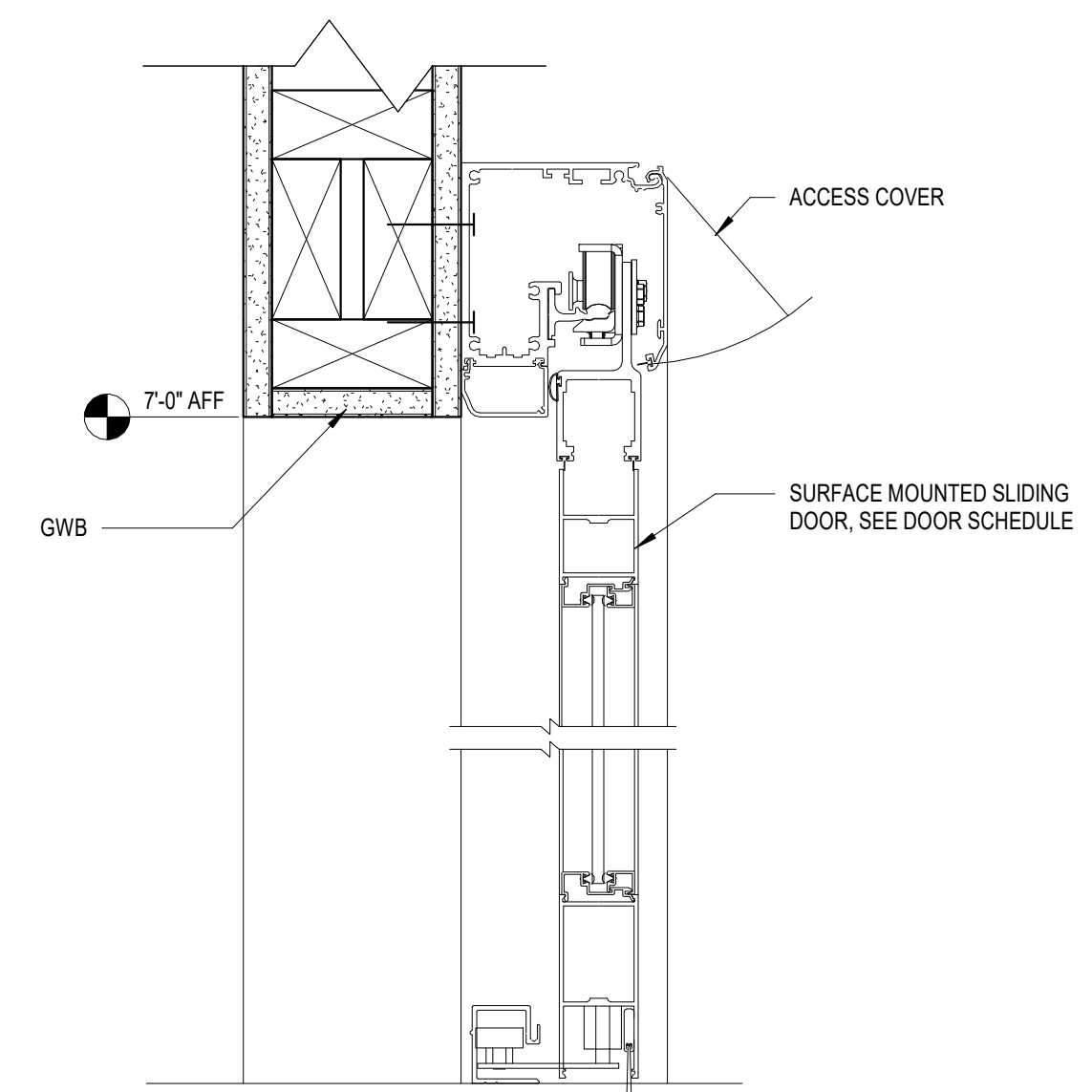

B4 A601 HEAD/SILL DETAIL ALUM SLIDING DOOR
3" = 1'-0"

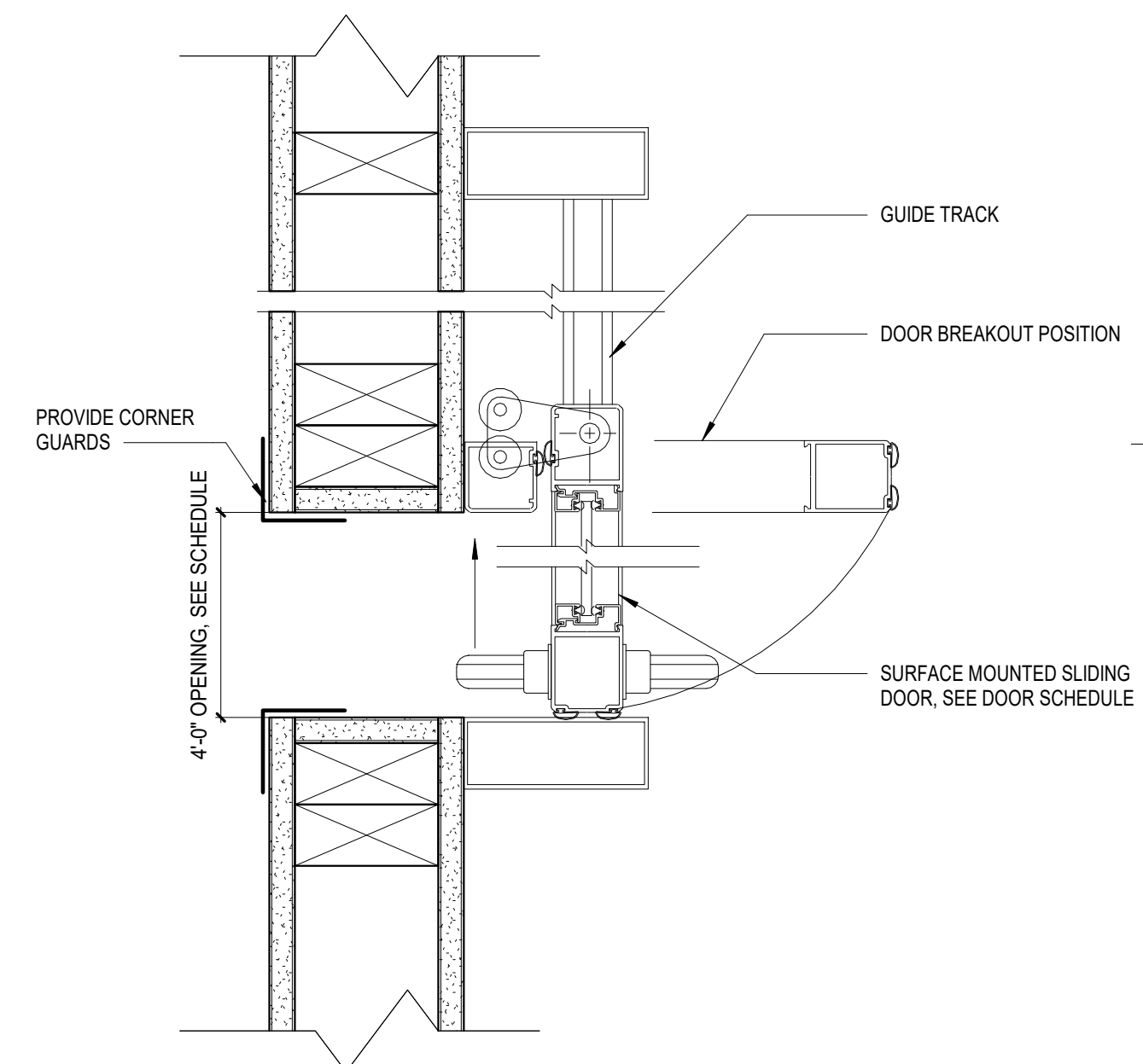

A4 A601 JAMB DETAIL ALUM SLIDING DOOR
3" = 1'-0"

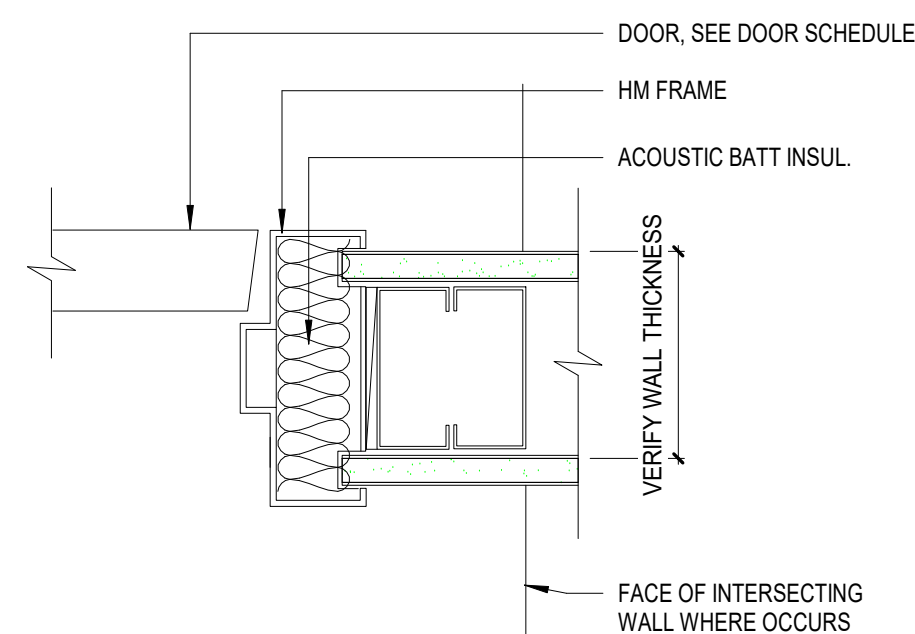

A1 A601 TYP. DOOR DETAIL JAMB/HEAD SIM.
3" = 1'-0"

Architects Alaska
ARCHITECTS ALASKA
AK Corp. Authorization AEC561
900 W. 5th Avenue, Suite 403
Anchorage, Alaska 99501-2029
907.272.3567 907.277.1732 fax
191 E. Swanson Avenue, Suite 203
Wasilla, Alaska 99564-7025
907.373.7503 907.376.3166 fax
347 S. Ferguson Ave, Suite 3
Bozeman, Montana 59715
406.404.1588
www.architectsalaska.com

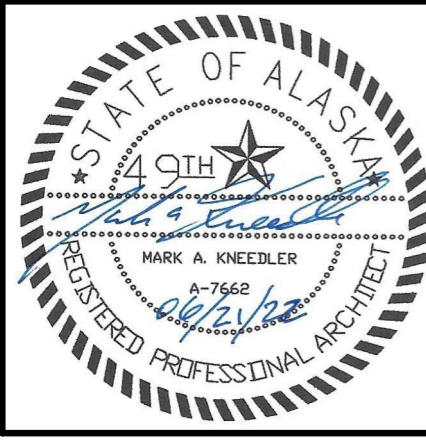

City and Borough of Juneau
BARTLETT REGIONAL HOSPITAL MRI & CT REPLACEMENT
 3260 Hospital Dr. Juneau, AK 99801

Revisions		
No.	Description	Date

Drawn by ARB	Date 06-17-2022
Checked MAK	Job No. 22008.01

Sheet Contents
DOOR SCHEDULE

Sheet No.
A601

STRUCTURAL GENERAL NOTES

CODE:

CONSTRUCTION SHALL BE IN CONFORMANCE WITH THE INTERNATIONAL BUILDING CODE (IBC), 2012 EDITION, AS AMENDED BY CITY AND BOROUGH OF JUNEAU.

LOAD CRITERIA:
RISK CATEGORY IV

SEISMIC:
SITE CLASS D
 $S_s = 0.555$
 $S_{ds} = 0.502$
SEISMIC DESIGN CATEGORY D

WIND:
 $V = 135$ MPH
EXPOSURE D

CONCRETE:

CONCRETE AND CONCRETE COMPONENTS SHALL BE IN CONFORMANCE WITH THE IBC. SUBMIT MIX DESIGN FOR REVIEW AND APPROVAL PRIOR TO MIXING. CONCRETE MIXING, PLACING, CONSOLIDATION, AND CURING SHALL BE IN CONFORMANCE WITH IBC. CONCRETE STRENGTH SHALL BE $f'_c = 4,000$ PSI AT 28 DAYS. CONCRETE AIR ENTRAINMENT SHALL BE $5\% \pm 1\%$.

CONCRETE REINFORCING SHALL CONFORM TO ASTM A615, GRADE 60. FABRICATE AND PLACE STEEL REINFORCEMENT IN ACCORDANCE WITH CRSI'S "MANUAL OF STANDARD PRACTICE". REINFORCING SHALL BE SUPPORTED ON WELL-CURED BLOCKS OR APPROVED METAL ACCESSORIES. WELDING OF REINFORCING IS PROHIBITED. PROVIDE MINIMUM CONCRETE COVER AS SHOWN ON THE PLANS.

STRUCTURAL STEEL:

STRUCTURAL STEEL SHALL CONFORM TO THE FOLLOWING:

ANGLES, CHANNELS, PLATES OR MISC SHAPES	ASTM A36
HOLLOW RECTANGULAR SECTIONS (HSS)	ASTM A500 GRADE B
THREADED RODS	ASTM A36

GALV: DENOTES HOT DIP GALVANIZED

EQUIPMENT SEISMIC ANCHORAGE	
LOCATION	ANCHORS
CT	
GANTRY	(4) $\frac{1}{2}" \phi \times 2\frac{3}{4}"$ EMBED SIMPSON STRONG BOLT 2
TABLE	(4) $\frac{1}{2}" \phi \times 2\frac{3}{4}"$ EMBED SIMPSON STRONG BOLT 2
CABINET	(4) $\frac{1}{2}" \phi \times 2\frac{3}{4}"$ EMBED SIMPSON STRONG BOLT 2
MRI	
MAGNET	(4) $\frac{1}{2}" \phi \times 3\frac{7}{8}"$ EMBED SIMPSON STRONG BOLT 2
CHILLER (EXTERIOR)	(4) $\frac{1}{2}" \phi \times 3\frac{7}{8}"$ EMBED SIMPSON STRONG BOLT 2 (GALV)

* FIELD VERIFY HOLE DIAMETER IN EQUIPMENT AND NOTIFY ENGINEER IF SMALLER DIAMETER ANCHORS ARE REQUIRED

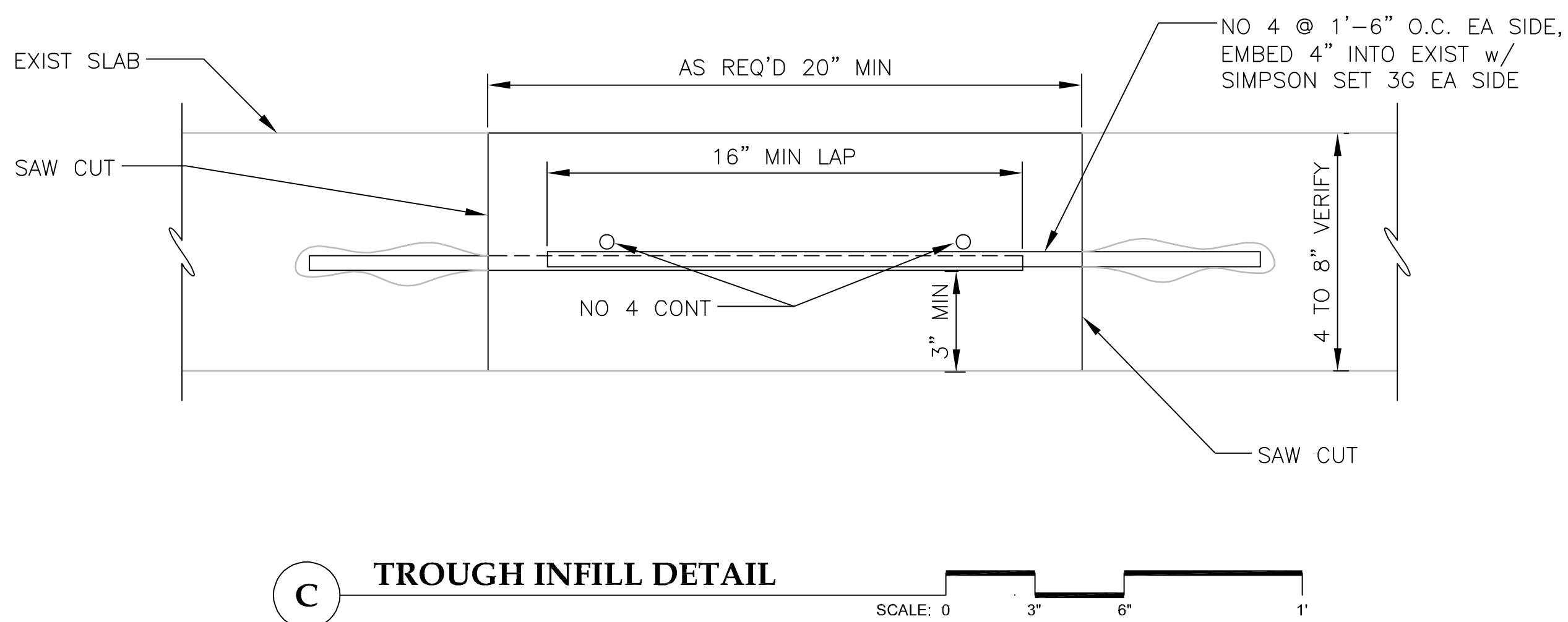
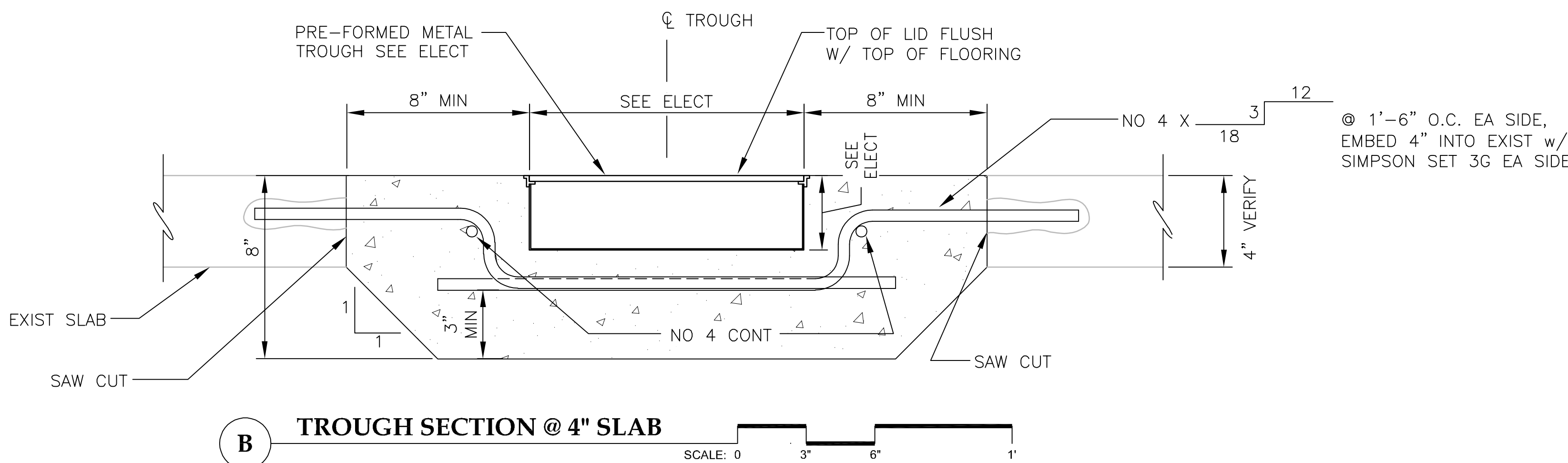
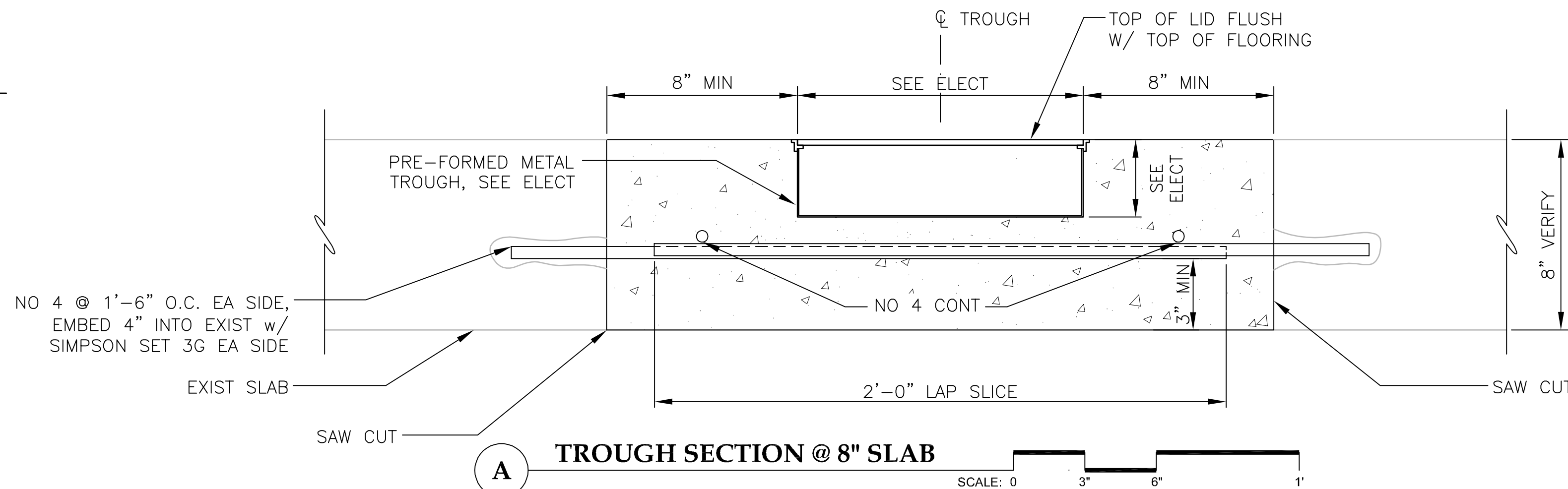

NOTE: SEE ELECTRICAL FOR TROUGH LOCATIONS

Architects Alaska
ARCHITECTS ALASKA
AK Corp. Authorization AECC561
900 W. 5th Avenue, Suite 403
Anchorage, Alaska 99501-2029
907.272.3567 907.277.1732 fax
191 E. Swanson Avenue, Suite 203
Wasilla, Alaska 99654-7025
907.373.7503 907.376.3166 fax
347 S. Ferguson Ave, Suite 3
Bozeman, Montana 59715
406.404.1588
www.architectsalaska.com

P N D
ENGINEERS, INC.
9360 Glacier Highway, Ste. 100
JUNEAU, ALASKA 99801
PHONE (907) 586-2093
FAX (907) 586-2099
PND Project No.: 222035
C.A.N.: AECC250

STATE OF ALASKA
49 TH
Brian C. Nielsen
SE-13703
REGISTERED PROFESSIONAL ENGINEER

City and Borough of Juneau (CBJ)
(BRH) MRT & CT Replacement
3260 Hospital Dr. Juneau, AK 99801

Revisions		
No.	Description	Date

Drawn by DD	Date 06-17-2022
Checked BN	Job No. 222035

Sheet Contents
STRUCTURAL GENERAL
NOTES AND DETAILS

Sheet No.
S101

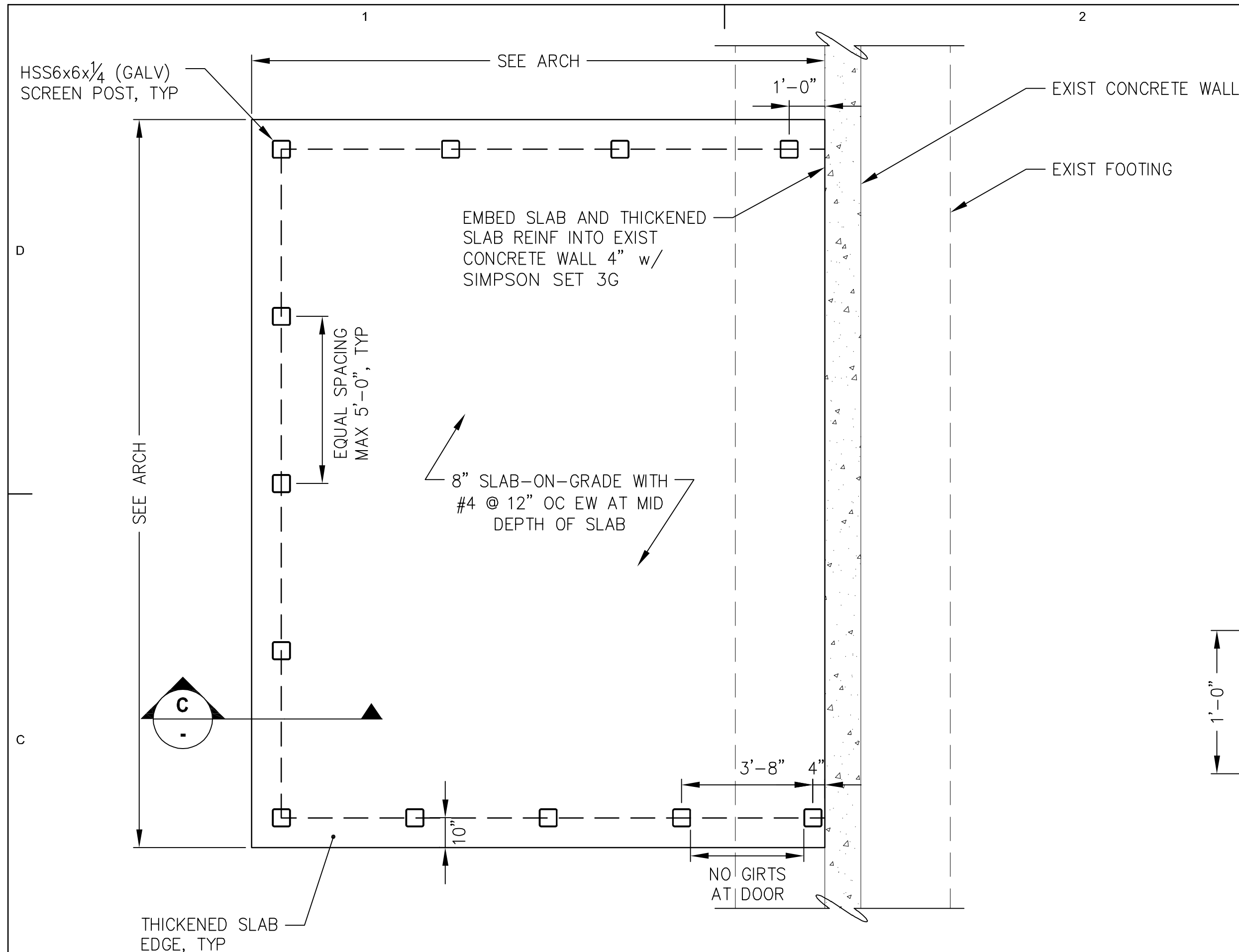

1 CHILLER PAD PLAN
NOTE: SEE ARCH FOR LOCATION

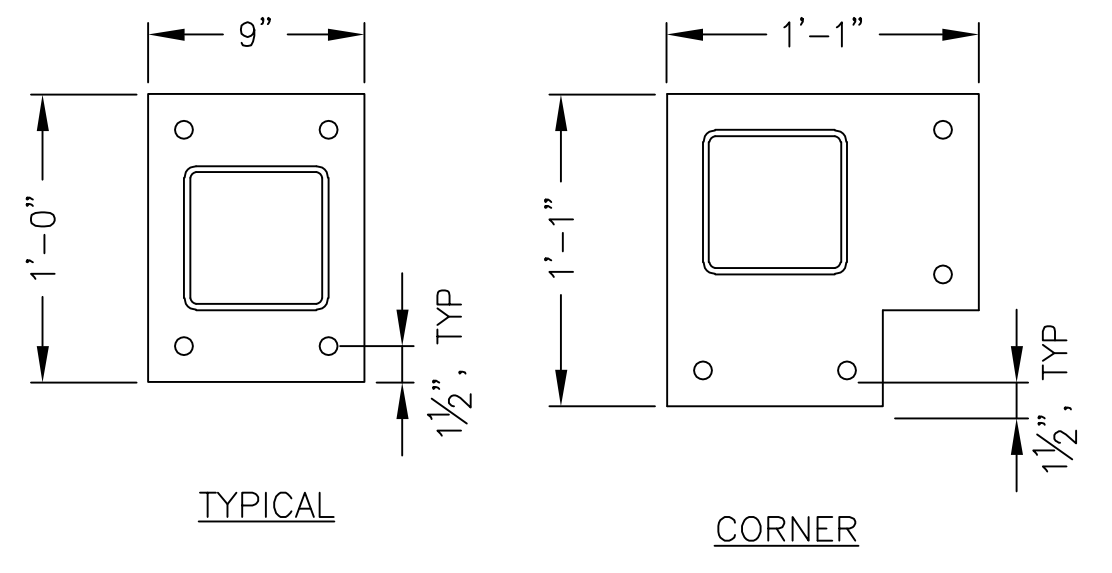

A BASE PLATE DETAILS

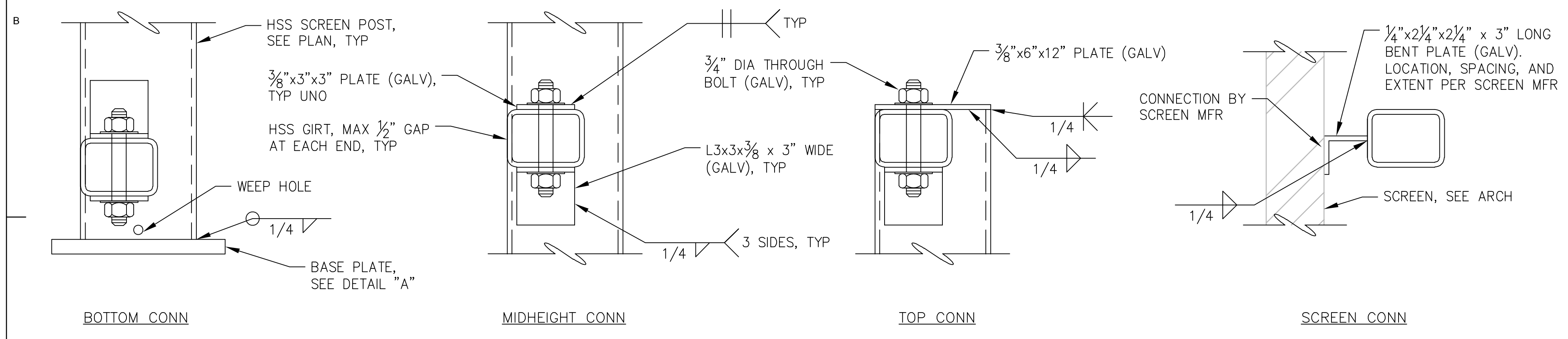

B TYPICAL CONNECTION DETAILS

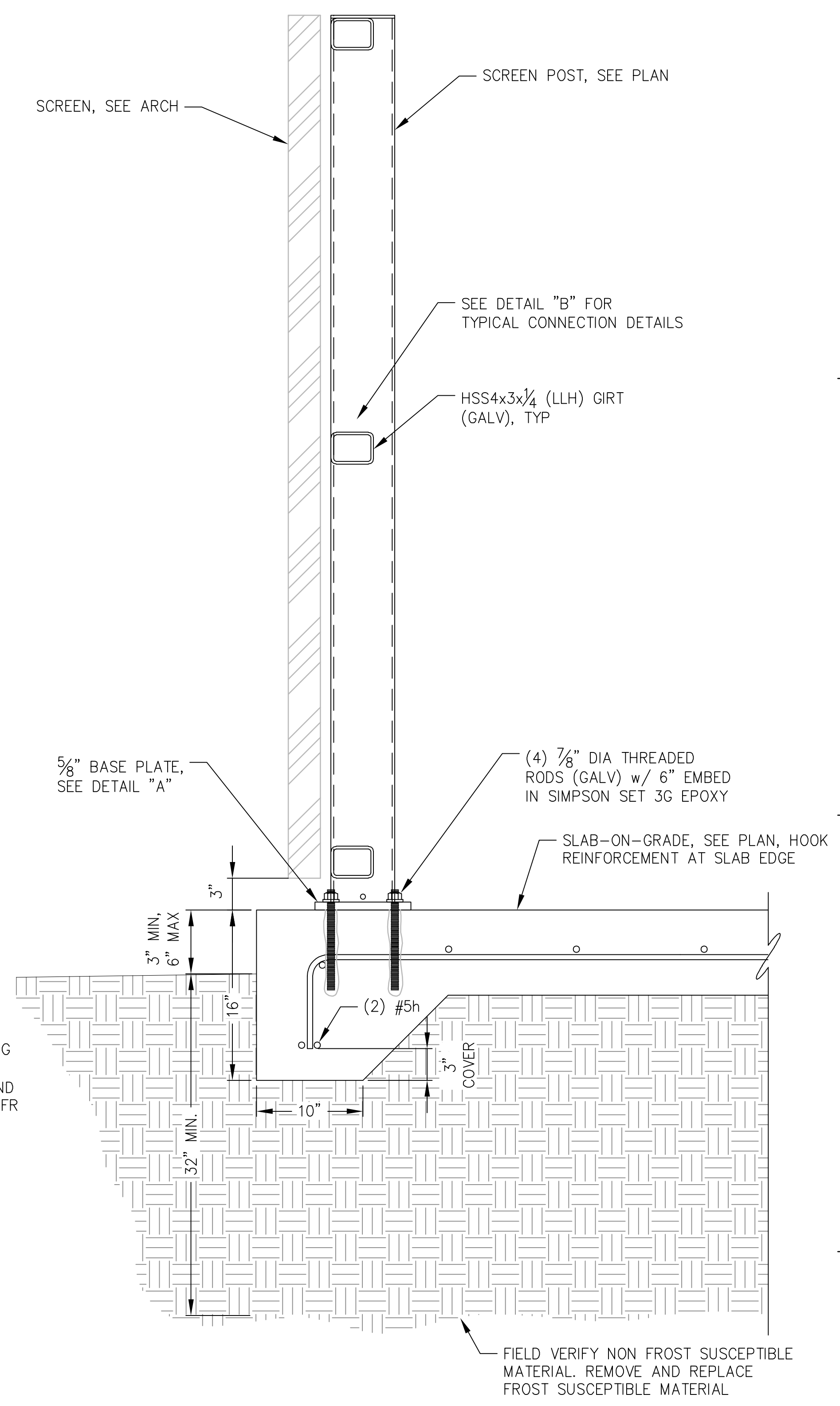

C CHILLER PAD AND SCREEN SECTION

Architects Alaska
ARCHITECTS ALASKA
AK Corp. Authorization AECC561
900 W. 5th Avenue, Suite 403
Anchorage, Alaska 99501-2029
907.272.3567 907.277.1732 fax
191 E. Swanson Avenue, Suite 203
Wasilla, Alaska 99654-7025
907.373.7503 907.376.3166 fax
347 S. Ferguson Ave, Suite 3
Bozeman, Montana 59715
406.404.1588
www.architectsalaska.com

P N D
ENGINEERS, INC.
9360 Glacier Highway, Ste. 100
JUNEAU, ALASKA 99801
PHONE (907) 586-2093
FAX (907) 586-2099
PND Project No.: 222035
C.A.N.: AECC250

STATE OF ALASKA
49 TH
Brian C. Nielsen
SE-13703
REGISTERED PROFESSIONAL ENGINEER

City and Borough of Juneau (CBJ)
(BRH) MRT & CT Replacement
3260 Hospital Dr. Juneau, AK 99801

Revisions		
No.	Description	Date

Drawn by DD	Date 06-17-2022
Checked by BN	Job No. 222035

Sheet Contents
STRUCTURAL DETAILS

Sheet No.
S102

Plot Date Time:

FILE NAME: x:\21339\p\m\c\dwg\m\chgsheet\files\21339 - M001.dwg
 PLOTTED: jpbac 6/17/2022 12:47 PM

ABBREVIATIONS

AT	INCH OR INCHES	IN OR "	INCH OR INCHES
AND	INCHES MERCURY	IN HG	INCHES MERCURY
#	INCHES WATER COLUMN	IN WC	INCHES WATER COLUMN
AD	PERCENT	%	PERCENT
AD	ACCESS DOOR		ACCESS DOOR
AAP	AREA ALARM PANEL		AREA ALARM PANEL
ADA	AMERICANS WITH DISABILITIES ACT		AMERICANS WITH DISABILITIES ACT
AFF	ABOVE FINISHED FLOOR		ABOVE FINISHED FLOOR
AFG	ABOVE FINISHED GRADE		ABOVE FINISHED GRADE
AHJ	AUTHORITY HAVING JURISDICTION		AUTHORITY HAVING JURISDICTION
AHU	AIR-HANDLING UNIT		AIR-HANDLING UNIT
ALT	ALTERNATE		ALTERNATE
AMB	AMBIENT		AMBIENT
AMCA	AIR MOVEMENT AND CONTROL ASSOCIATION		AIR MOVEMENT AND CONTROL ASSOCIATION
ANSI	AMERICAN NATIONAL STANDARDS INSTITUTE		AMERICAN NATIONAL STANDARDS INSTITUTE
APD	AIR PRESSURE DROP		AIR PRESSURE DROP
APPROX	APPROXIMATE		APPROXIMATE
AR	ACID RESISTANT		ACID RESISTANT
ARCH	ARCHITECTURAL		ARCHITECTURAL
ASME	AMERICAN SOCIETY OF MECHANICAL ENGINEERS		AMERICAN SOCIETY OF MECHANICAL ENGINEERS
ATM	ATMOSPHERE		ATMOSPHERE
AUTO	AUTOMATIC		AUTOMATIC
AVG	AVERAGE		AVERAGE
AWG	AMERICAN WIRE GAUGE		AMERICAN WIRE GAUGE
BAS	BUILDING AUTOMATION SYSTEM		BUILDING AUTOMATION SYSTEM
BDD	BACKDRAFT DAMPER		BACKDRAFT DAMPER
BHP	BRAKE HORSEPOWER, BOILER HORSEPOWER		BRAKE HORSEPOWER, BOILER HORSEPOWER
BLDG	BUILDING		BUILDING
BLW	BELOW		BELOW
BOD	BOTTOM OF DUCT		BOTTOM OF DUCT
BOP	BOTTOM OF PIPE		BOTTOM OF PIPE
BTU	BRITISH THERMAL UNIT		BRITISH THERMAL UNIT
BTUH	BTU PER HOUR		BTU PER HOUR
C	COMMON, CONDENSATE		COMMON, CONDENSATE
C-C	CENTER TO CENTER		CENTER TO CENTER
CAP	CAPACITY, END CAP		CAPACITY, END CAP
CCW	COUNTER-CLOCKWISE		COUNTER-CLOCKWISE
CF	COOLING FAN, CIRCULATING FAN, CUBIC FOOT		COOLING FAN, CIRCULATING FAN, CUBIC FOOT
CFM	CUBIC FEET PER MINUTE		CUBIC FEET PER MINUTE
CI	CAST IRON		CAST IRON
CL	CENTER LINE		CENTER LINE
CLG	CEILING		CEILING
CMPR	COMPRESSOR		COMPRESSOR
COEF	COEFFICIENT		COEFFICIENT
CONC	CONCRETE		CONCRETE
COND	CONDENSER		CONDENSER
CTR	CENTER		CENTER
CU	COPPER, CONDENSING UNIT		COPPER, CONDENSING UNIT
CU IN	CUBIC INCH		CUBIC INCH
CW	VALVE FLOW COEFFICIENT		VALVE FLOW COEFFICIENT
CW	CLOCKWISE		CLOCKWISE
DB	DECIBEL		DECIBEL
DBT	DRY-BULB TEMPERATURE		DRY-BULB TEMPERATURE
DDC	DIRECT DIGITAL CONTROL		DIRECT DIGITAL CONTROL
DEG	DEGREE		DEGREE
DEG C	DEGREE CENTIGRADE		DEGREE CENTIGRADE
DEG F	DEGREE FAHRENHEIT		DEGREE FAHRENHEIT
DEMO	DEMOLITION		DEMOLITION
DENS	DENSITY		DENSITY
DGM	DIAGRAM		DIAGRAM
DI	DUCTILE IRON		DUCTILE IRON
DIA	DIAMETER		DIAMETER
DIFF	DIFFERENCE OR DELTA		DIFFERENCE OR DELTA
DIP	DUCTILE IRON PIPE		DUCTILE IRON PIPE
DISS	DIAMETER-INDEX SAFETY SYSTEM		DIAMETER-INDEX SAFETY SYSTEM
DN	DOWN		DOWN
DO	DITTO		DITTO
DTL	DETAIL		DETAIL
DWDI	DOUBLE WIDTH DOUBLE INLET		DOUBLE WIDTH DOUBLE INLET
DWG	DRAWING		DRAWING
(E)	EXISTING		EXISTING
EA	EACH		EACH
E/A	EXHAUST AIR		EXHAUST AIR
EAT	ENTERING AIR TEMPERATURE		ENTERING AIR TEMPERATURE
EF	EXHAUST FAN		EXHAUST FAN
EFF	EFFICIENCY		EFFICIENCY
EG	ETHYLENE GLYCOL, EXHAUST GRILLE		ETHYLENE GLYCOL, EXHAUST GRILLE
ELEC	ELECTRICAL		ELECTRICAL
ELEV	ELEVATION		ELEVATION
EMB	EMBEDMENT		EMBEDMENT
ENT	ENTERING		ENTERING
EQV	EQUIVALENT FEET		EQUIVALENT FEET
ESP	EXTERNAL STATIC PRESSURE		EXTERNAL STATIC PRESSURE
EVAP	EVAPORATOR		EVAPORATOR
EXP	EXPANSION		EXPANSION
EWT	ENTERING WATER TEMPERATURE		ENTERING WATER TEMPERATURE
'F	FAHRENHEIT		FAHRENHEIT
FA	FACE AREA		FACE AREA
F-F	FACE TO FACE		FACE TO FACE
FD	FIRE DAMPER		FIRE DAMPER
FLEX	FLEXIBLE		FLEXIBLE
FLR	FLOOR		FLOOR
FOB	FLAT ON BOTTOM		FLAT ON BOTTOM
FOT	FLAT ON TOP		FLAT ON TOP
FP	FREEZING POINT		FREEZING POINT
FFM	FEET PER MINUTE		FEET PER MINUTE
FPS	FEET PER SECOND		FEET PER SECOND
FSD	FIRE-SMOKE DAMPER		FIRE-SMOKE DAMPER
FSDM	FIRE-SMOKE DAMPER, MODULATING		FIRE-SMOKE DAMPER, MODULATING
FT	FOOT OR FEET		FOOT OR FEET
FV	FACE VELOCITY		FACE VELOCITY
GA	GAGE OR GAUGE		GAGE OR GAUGE
GAL	GALLONS		GALLONS
GPD	GALLONS PER DAY		GALLONS PER DAY
GPH	GALLONS PER HOUR		GALLONS PER HOUR
GPM	GALLONS PER MINUTE		GALLONS PER MINUTE
GR	GRAINS		GRAINS
GRD	GRILLES, REGISTERS, DIFFUSERS		GRILLES, REGISTERS, DIFFUSERS
HD	HEAD		HEAD
HDPE	HIGH DENSITY POLYETHYLENE		HIGH DENSITY POLYETHYLENE
HG	HEAT GAIN		HEAT GAIN
HT	HEIGHT		HEIGHT
HP	HORSEPOWER		HORSEPOWER
HR	HOUR(S)		HOUR(S)
HVAC	HEATING, VENTILATING & AIR-CONDITIONING		HEATING, VENTILATING & AIR-CONDITIONING
HZ	FREQUENCY		FREQUENCY
IAW	IN ACCORDANCE WITH		IN ACCORDANCE WITH
ID	INSIDE DIAMETER		INSIDE DIAMETER
IE	INVERT ELEVATION		INVERT ELEVATION
IBC	INTERNATIONAL BUILDING CODE		INTERNATIONAL BUILDING CODE
IFC	INTERNATIONAL FIRE CODE		INTERNATIONAL FIRE CODE
IMC	INTERNATIONAL MECHANICAL CODE		INTERNATIONAL MECHANICAL CODE
IN	INCH		INCH
IN HG	INCHES MERCURY		INCHES MERCURY
IN WC	INCHES WATER COLUMN		INCHES WATER COLUMN
INSUL	INSULATION		INSULATION
IPS	INTERNATIONAL PIPE STANDARD THERMAL CONDUCTIVITY		INTERNATIONAL PIPE STANDARD THERMAL CONDUCTIVITY
K	KILOWATT		KILOWATT
KW	KILOWATT HOUR		KILOWATT HOUR
KWH	KILOWATT HOUR		KILOWATT HOUR
LAT	LEAVING AIR TEMPERATURE		LEAVING AIR TEMPERATURE
LB/HR	POUNDS PER HOUR		POUNDS PER HOUR
LBS	POUNDS		POUNDS
LF	LINEAR FEET		LINEAR FEET
L	LENGTH		LENGTH
LWT	LEAVING WATER TEMPERATURE		LEAVING WATER TEMPERATURE
LOC	LOCATION/LOCATED		LOCATION/LOCATED
LP	LOW PRESSURE		LOW PRESSURE
LR	LONG RADIUS		LONG RADIUS
MAN	MANUAL		MANUAL
MAT	MIXED AIR TEMPERATURE		MIXED AIR TEMPERATURE
MAV	MANUAL AIR VENT		MANUAL AIR VENT
MAX	MAXIMUM		MAXIMUM
MBH	THOUSAND BTU PER HOUR		THOUSAND BTU PER HOUR
MECH	MECHANICAL		MECHANICAL
MFR	MANUFACTURER		MANUFACTURER
MH	MANHOLE		MANHOLE
MIN	MINIMUM, MINUTE		MINIMUM, MINUTE
MPH	MILES PER HOUR		MILES PER HOUR
MTD	MOUNTED		MOUNTED
N/A	NOT APPLICABLE		NOT APPLICABLE
NC	NOISE CRITERIA, NORMALLY CLOSED		NOISE CRITERIA, NORMALLY CLOSED
NFPA	NATIONAL FIRE PROTECTION ASSOCIATION		NATIONAL FIRE PROTECTION ASSOCIATION
NO	NOT IN CONTRACT		NOT IN CONTRACT
NO	NORMALLY OPEN, NUMBER		NORMALLY OPEN, NUMBER
NTS	NOT TO SCALE		NOT TO SCALE
OD	OUTSIDE DIAMETER		OUTSIDE DIAMETER
OFOI	OWNER FURNISHED, OWNER INSTALLED		OWNER FURNISHED, OWNER INSTALLED
OSA	OUTSIDE AIR		OUTSIDE AIR
OZ	OUNCE		OUNCE
PD	PRESSURE DROP OR DIFFERENCE		PRESSURE DROP OR DIFFERENCE
PG	PROPYLENE GLYCOL		PROPYLENE GLYCOL
PL	PLATE		PLATE
PLBG	PLUMBING		PLUMBING
POC	POINT OF CONNECTION		POINT OF CONNECTION
PNL	PANEL		PANEL
PH	PHASE (ELECTRICAL)		PHASE (ELECTRICAL)
PPM	PARTS PER MILLION		PARTS PER MILLION
PSI	POUNDS PER SQUARE INCH		POUNDS PER SQUARE INCH
PSIA	POUNDS PER SQUARE INCH - ABSOLUTE		POUNDS PER SQUARE INCH - ABSOLUTE
PSID	POUNDS PER SQUARE INCH - DIFFERENTIAL		POUNDS PER SQUARE INCH - DIFFERENTIAL
PSIG	POUNDS PER SQUARE INCH - GAUGE		POUNDS PER SQUARE INCH - GAUGE
PRESS	PRESSURE		PRESSURE
PRI	PRIMARY		PRIMARY
R-407C	REFRIGERANT (407C,410A,ETC.)		REFRIGERANT (407C,410A,ETC.)
R-410A	REFRIGERANT (407C,410A,ETC.)		REFRIGERANT (407C,410A,ETC.)
R/A	RETURN AIR		RETURN AIR
RA	RADIANT OR RADIATION		RADIANT OR RADIATION
RCVR	RECEIVER		RECEIVER
RECIRC	RECIRCULATE		RECIRCULATE
RED	REDUCER		REDUCER
REFRIG	REFRIGERATION		REFRIGERATION
REV	REVOLUTIONS		REVOLUTIONS
RF	RELIEF FAN OR RETURN FAN		RELIEF FAN OR RETURN FAN
RH	RELATIVE HUMIDITY		RELATIVE HUMIDITY
RM	ROOM		ROOM
RPM	REVOLUTIONS PER MINUTE		REVOLUTIONS PER MINUTE
RPS	REVOLUTIONS PER SECOND		REVOLUTIONS PER SECOND
S/A	SUPPLY AIR		SUPPLY AIR
SAT	SATURATION		SATURATION
SCHD	SCHEDULE		SCHEDULE
SCFM	STANDARD CUBIC FEET PER MINUTE		STANDARD CUBIC FEET PER MINUTE
SD	STORM DRAIN		STORM DRAIN
SEC	SECONDARY		SECONDARY
SF	SQUARE FEET		SQUARE FEET
SH	SENSIBLE HEAT		SENSIBLE HEAT
SHG	SENSIBLE HEAT GAIN		SENSIBLE HEAT GAIN
SHR	SENSIBLE HEAT RATIO		SENSIBLE HEAT RATIO
SHT	SHEET		SHEET
SP	STATIC PRESSURE		STATIC PRESSURE
SPD	STATIC PRESSURE DROP		STATIC PRESSURE DROP
SPEC	SPECIFICATION, SPECIFIED		SPECIFICATION, SPECIFIED
SPKLR	SPRINKLER		SPRINKLER
SR	SHORT RADIUS		SHORT RADIUS
SWSI	SINGLE WIDTH SINGLE INLET		SINGLE WIDTH SINGLE INLET
SQ	SQUARE		SQUARE
SS	STAINLESS STEEL, SANITARY SEWER		STAINLESS STEEL, SANITARY SEWER
STD	STANDARD		STANDARD
SUCT	SUCTION		SUCTION
TA	TRANSFER AIR		TRANSFER AIR
TEMP	TEMPERATURE, TEMPORARY		TEMPERATURE, TEMPORARY
THRU	THROUGH		THROUGH
TOP	TOP OF DUCT		TOP OF DUCT
TONS	TONS OF REFRIGERATION		TONS OF REFRIGERATION
TOP	TOP OF PIPE		TOP OF PIPE
TYP	TYPICAL		TYPICAL
UC	UNDERGROUND		UNDERGROUND
UNO	UNLESS NOTED OTHERWISE		UNLESS NOTED OTHERWISE
UPC	UNIFORM PLUMBING CODE		UNIFORM PLUMBING CODE
V	VOLTS OR VOLTAGE		VOLTS OR VOLTAGE
VAC	VACUUM		VACUUM
VAC	VOLTS (ALTERNATING CURRENT)		VOLTS (ALTERNATING CURRENT)
VAL	VALVE		VALVE
VAP	VAPOR PRESSURE		VAPOR PRESSURE
VAR	VARIABLE		VARIABLE
VAV	VARIABLE AIR VOLUME		VARIABLE AIR VOLUME
VDC	VOLTS (DIRECT CURRENT)		VOLTS (DIRECT CURRENT)
VEL	VELOCITY		VELOCITY
VERT	VERTICAL		VERTICAL
VFD	VARIABLE FREQUENCY DRIVE		VARIABLE FREQUENCY DRIVE
VOL	VOLUME		VOLUME
VP	VELOCITY PRESSURE		VELOCITY PRESSURE
VSD	VARIABLE SPEED DRIVE		VARIABLE SPEED DRIVE
VTR	VENT THROUGH ROOF		VENT THROUGH ROOF
W	WATT		WATT
W/	WITH		WITH
W/O	WITHOUT		WITHOUT
WB	WET BULB TEMPERATURE		WET BULB TEMPERATURE
WC	WATER COLUMN		WATER COLUMN
WH	WATT-HOUR		WATT-HOUR
WP	WEATHER PROOF, WATER PROOF		WEATHER PROOF, WATER PROOF
WPD	WATER PRESSURE DROP		WATER PRESSURE DROP
WT	WEIGHT		WEIGHT
YD	YARD		YARD
ZVB	ZONE VALVE BOX		ZONE VALVE BOX

NOTE: THIS IS A STANDARD LEGEND, SOME OF THE SYMBOLS SHOWN ON LEGEND ARE NOT NECESSARILY ON THE DRAWINGS.

GENERAL

SYMBOL	DESCRIPTION
	SHEET NOTE CONVENTION: REFERENCED SHEET NOTE GENERAL SHEET NOTE
	DETAIL REFERENCE DETAIL NUMBER SHEET WHERE DETAIL APPEARS
	SECTION REFERENCE SECTION LETTER SHEET WHERE SECTION APPEARS
	POINT OF CONNECTION
	PLUMBING FIXTURE NUMBER
	EQUIPMENT TAG
	EQUIPMENT DESIGNATION EQUIPMENT NUMBER
	AIR OUTLET TAG
	AIR OUTLET DESIGNATION CFM
	AIR TERMINAL UNIT TAG
	LINE CONVENTION NEW OR REINSTALLED ITEM ITEM TO BE DEMOLISHED EXISTING ITEM TO REMAIN EXISTING ITEM TO BE RELOCATED

VENTILATION

SYMBOL	ABBR.	DESCRIPTION
		DOUBLE LINE DUCTWORK
		SINGLE LINE DUCTWORK
		FLEX DUCTWORK
		SLOT GRILLES/REGISTERS/DIFFUSERS
	S/A	GRILLES/REGISTERS/DIFFUSERS - SUPPLY AIR
	R/A	GRILLES/REGISTERS/DIFFUSERS - RETURN AIR
	E/A	GRILLES/REGISTERS/DIFFUSERS - EXHAUST AIR
		AIR FLOW ARROW
	VD	AIR VOLUME DAMPER
	FD	FIRE DAMPER
	SD	SMOKE DAMPER
	FSD	FIRE-SMOKE DAMPER
	AL	ACOUSTICAL DUCT LINING
		DUCT INSULATION
		DUCT: ROUND
		DUCT: RECTANGULAR FIRST FIGURE SIDE SHOWN
	MOD	MOTORIZED OPERATED DAMPER
	OBD	OPPOSED BLADE DAMPER
	PBD	PARALLEL BLADE DAMPER
		DAMPER
		DUCT TURNING UP OR TOWARD
		DUCT TURNING DOWN OR AWAY

PIPING

SYMBOL	ABBR.	DESCRIPTION
	HWS	HEATING WATER SUPPLY
	HWR	HEATING WATER RETURN
	GCS	GLYCOL COOLING SUPPLY
	GCR	GLYCOL COOLING RETURN

GENERAL PIPING

- SHEET NOTES**
1. PAD MOUNTED CHILLER WITH INTEGRAL PUMP PACKAGE. COORDINATE LOCATION WITH ARCHITECTURAL AND CIVIL.
 2. 10 LINEAL FEET OF 12" GCS AND GCR TO PROVIDE MINIMUM CHILLED LOOP CIRCULATION TIME.
 3. COORDINATE EXTENTS OF DEMOLITION WITH NEW WORK.
 4. SEE 1/M601 FOR CENTRAL CHILLED GLYCOL PIPING DIAGRAM.

Architects Alaska
ARCHITECTS ALASKA
 AK Corp. Authorization AECC561
 900 W. 5th Avenue, Suite 403
 Anchorage, Alaska 99501-2029
 907.272.3567 907.277.1732 fax
 191 E. Swanson Avenue, Suite 203
 Wasilla, Alaska 99654-7025
 907.373.7503 907.376.3166 fax
 347 S. Ferguson Ave. Suite 3
 Bozeman, Montana 59715
 406.404.1588
 www.architectsalaska.com

AMC ENGINEERS
 www.amc-engineers.com
 Adams, Morgenthaler & Co., Inc.
 CoA No. C3342 - 907.257.9100
 701 E. Tudor Rd. Suite 250
 Anchorage, AK 99503

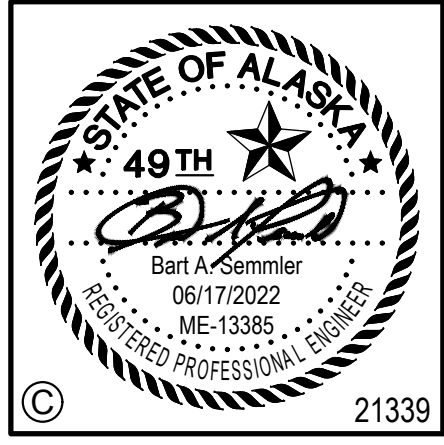

City and Borough of Juneau
BARTLETT REGIONAL HOSPITAL MRI & CT REPLACEMENT
 3260 Hospital Dr. Juneau, AK 99801

Revisions		
No.	Description	Date

Drawn by ERP/MLJ/LZ	Date 06/17/2022
Checked BAS	Job No. 22008.01

Sheet Contents
 MECHANICAL OVERALL

Sheet No.
M101



1 OVERALL PLAN - MECHANICAL
 M101 SCALE: 1/16" = 1'-0"

FILE NAME: x:\21339\h\m\m\c\Drawings\sheet files\21339 - M101.dwg
 PLOTTED: jpbac 6/17/2022 12:47 PM

- ### SHEET NOTES
- 1 DEMOLISH RETURN DUCTING IN PREPARATION FOR INSTALLATION OF NEW RETURN DUCTING.
 - 2 DEMOLISH SUPPLY DUCTING IN PREPARATION FOR INSTALLATION OF NEW SUPPLY DUCTING.
 - 3 CLEAN AND REFURBISH DUCT MOUNTED HUMIDIFICATION UNIT AND VERIFY PROPER FUNCTION OF HUMIDIFICATION EQUIPMENT AND CONTROLS.
 - 4 ROUTE 2" GCS/R PIPING TO AC-X, SEE DIAGRAM 1/M601 FOR VALVING AND CONNECTION.
 - 5 DASHED BOX INDICATES EXISTING RAIN LEADER PIPING RUN THROUGH THE CT SCAN ROOM ABOVE THE CEILING AT APPROXIMATELY THIS LOCATION.
 - 6 EXISTING SUPPLY DIFFUSER. BALANCE TO AIRFLOW SHOWN.
 - 7 SEE 3/M601 FOR AC-X ELEVATION.
 - 8 COORDINATE EXTENTS OF DEMOLITION WITH NEW WORK.
 - 9 EXISTING LINWORK TAKEN FROM EXISTING BUILDING AS-BUILT DRAWINGS AND LIMITED FIELD INVESTIGATION. FIELD VERIFY EXISTING CONDITIONS.
 - 10 SEE 4/M601 FOR TYPICAL PIPE AND DUCT INTERIOR WALL PENETRATION DETAIL.
 - 11 SEE 1/M602 FOR TYPICAL FLEXIBLE DUCT CONNECTION DETAIL.
 - 12 SEE 2/M602 FOR TYPICAL DUCT FITTING DETAIL.

Architects Alaska
ARCHITECTS ALASKA
 AK Corp. Authorization AECC561
 900 W. 5th Avenue, Suite 403
 Anchorage, Alaska 99501-2029
 907.272.3567 907.277.1732 fax
 191 E. Swanson Avenue, Suite 203
 Wasilla, Alaska 99654-7025
 907.373.7503 907.376.3166 fax
 347 S. Ferguson Ave., Suite 3
 Bozeman, Montana 59715
 406.404.1588
 www.architectsalaska.com

AMC ENGINEERS
 www.amc-engineers.com
 Adams, Morgenthaler & Co., Inc.
 Co. No. C3342 - 907.257.9100
 701 E. Tudor Rd., Suite 250
 Anchorage, AK 99503

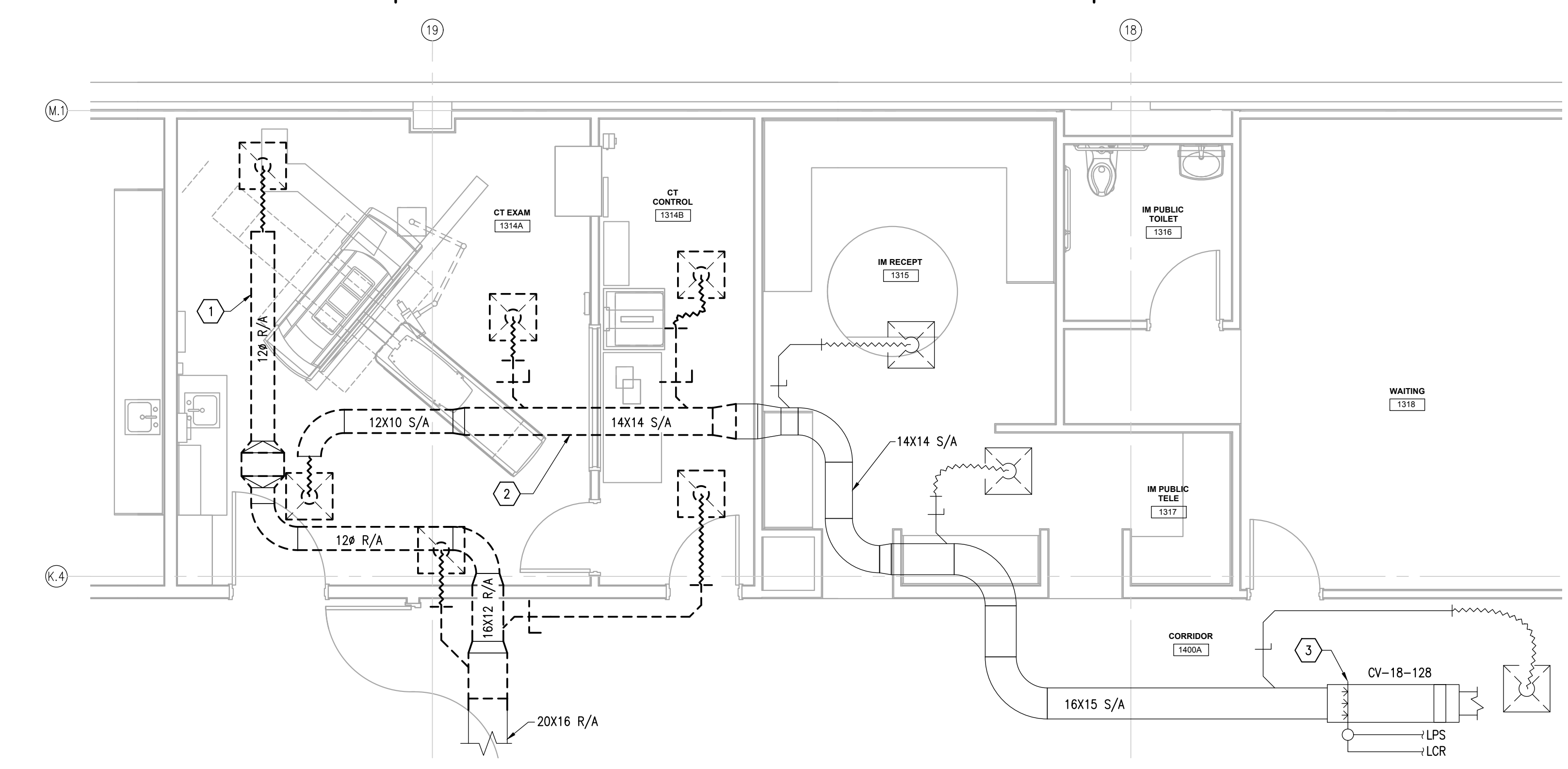
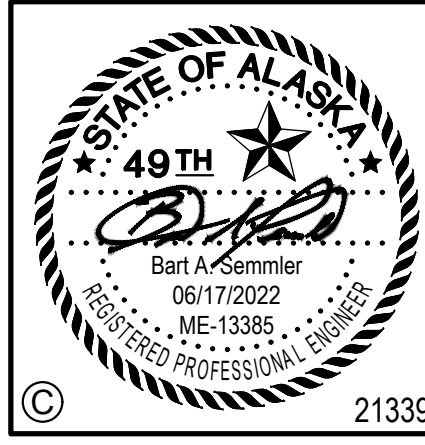

1 ENLARGED PLAN - MECHANICAL - CT RM 1314 - DEMO
 M201 SCALE: 1/4" = 1'-0"
 0 2' 4' 8' 12'

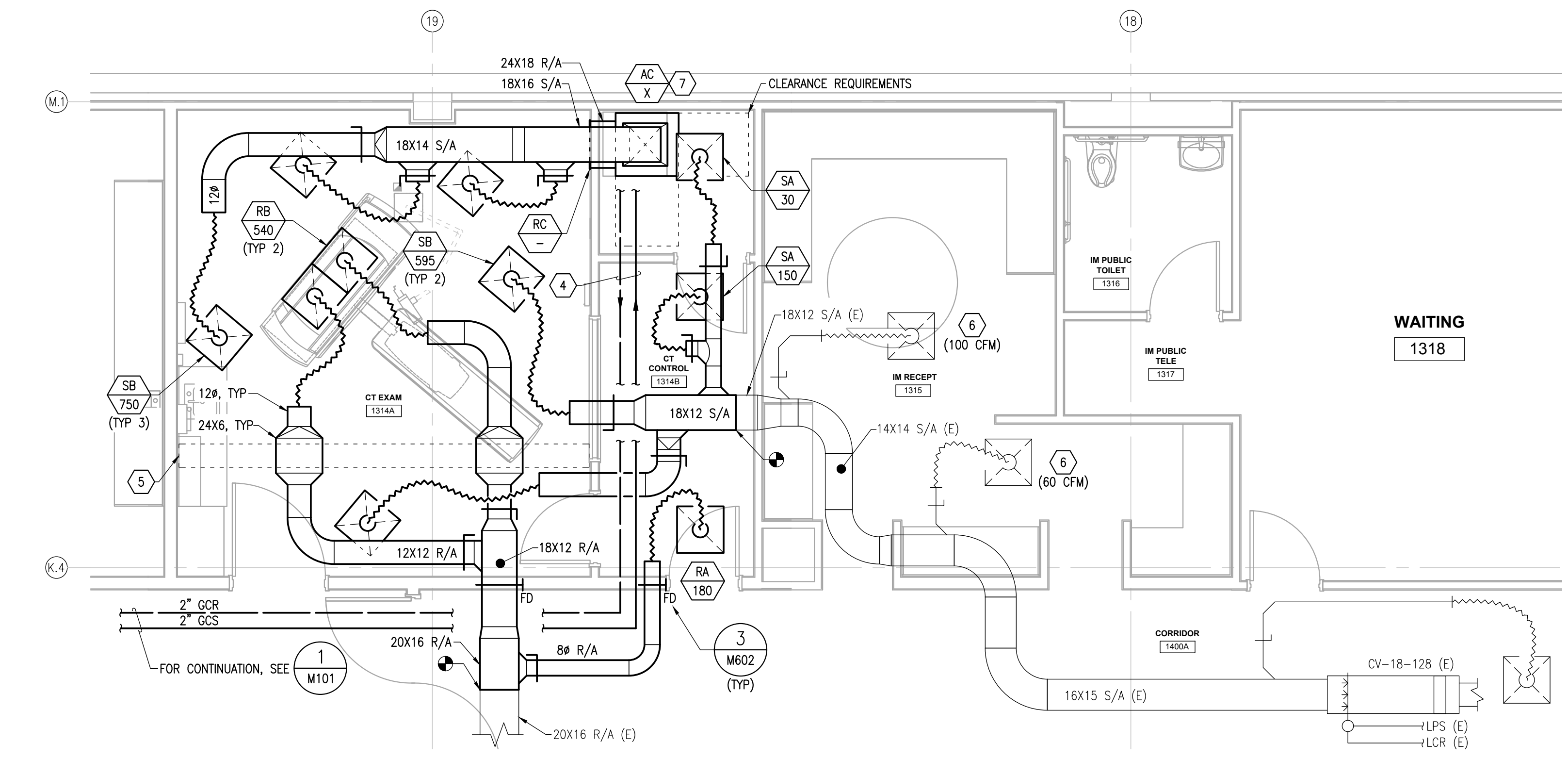

2 ENLARGED PLAN - MECHANICAL - CT RM 1314 - NEW
 M201 SCALE: 1/4" = 1'-0"
 0 2' 4' 8' 12'

City and Borough of Juneau
BARTLETT REGIONAL HOSPITAL MRI
& CT REPLACEMENT
 3260 Hospital Dr. Juneau, AK 99801

Revisions		
No.	Description	Date

Drawn by ERP/MLJ/LZ	Date 06/17/2022
Checked BAS	Job No. 22008.01

Sheet Contents
 ENLARGED PLAN - MECHANICAL -
 CT RM 1314 - DEMO AND NEW

Sheet No.
M201

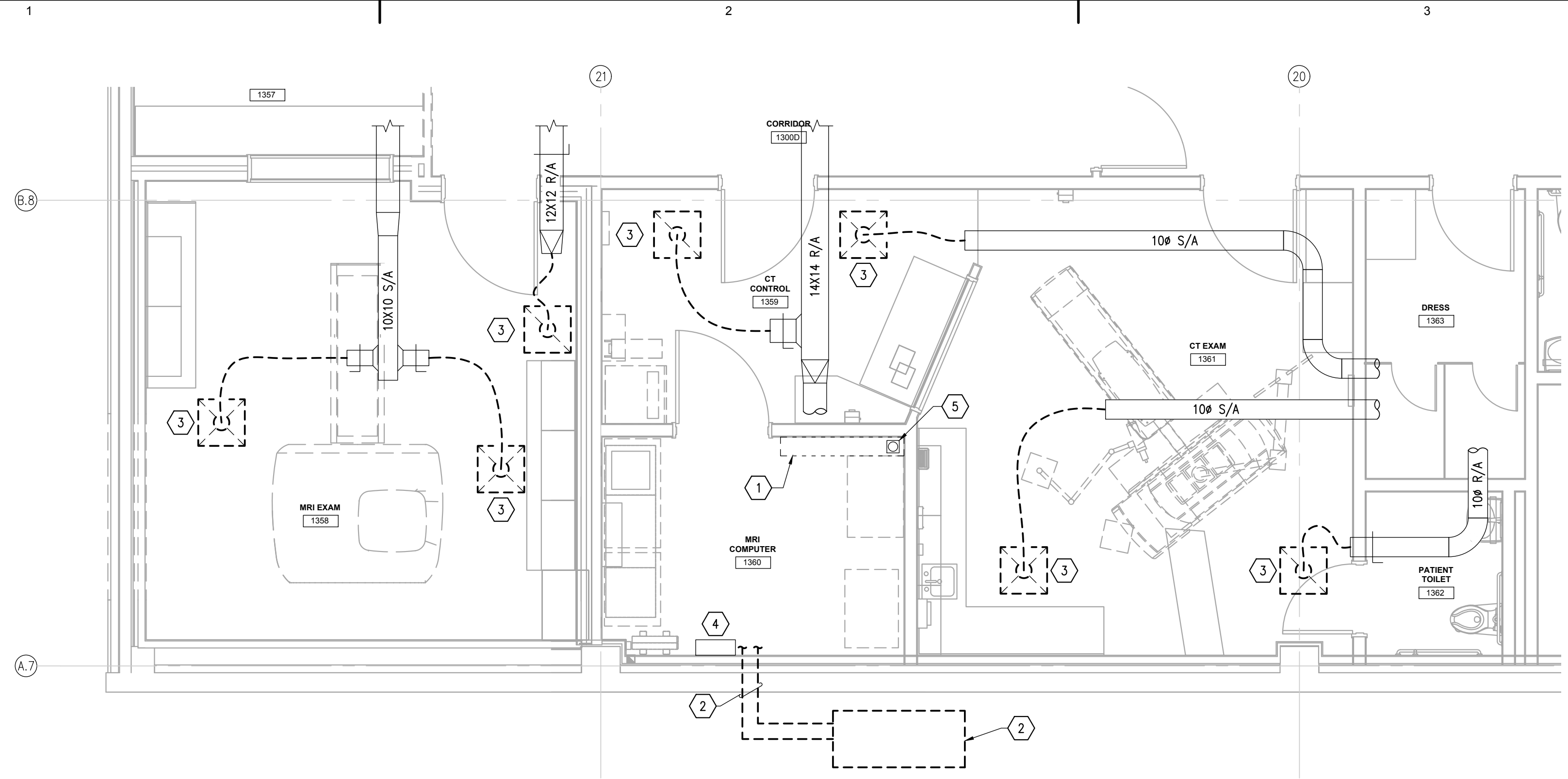

1 ENLARGED PLAN - MECHANICAL - CT RM 1361 AND MRI 1358 - DEMO
 M202 SCALE: 1/4" = 1'-0"

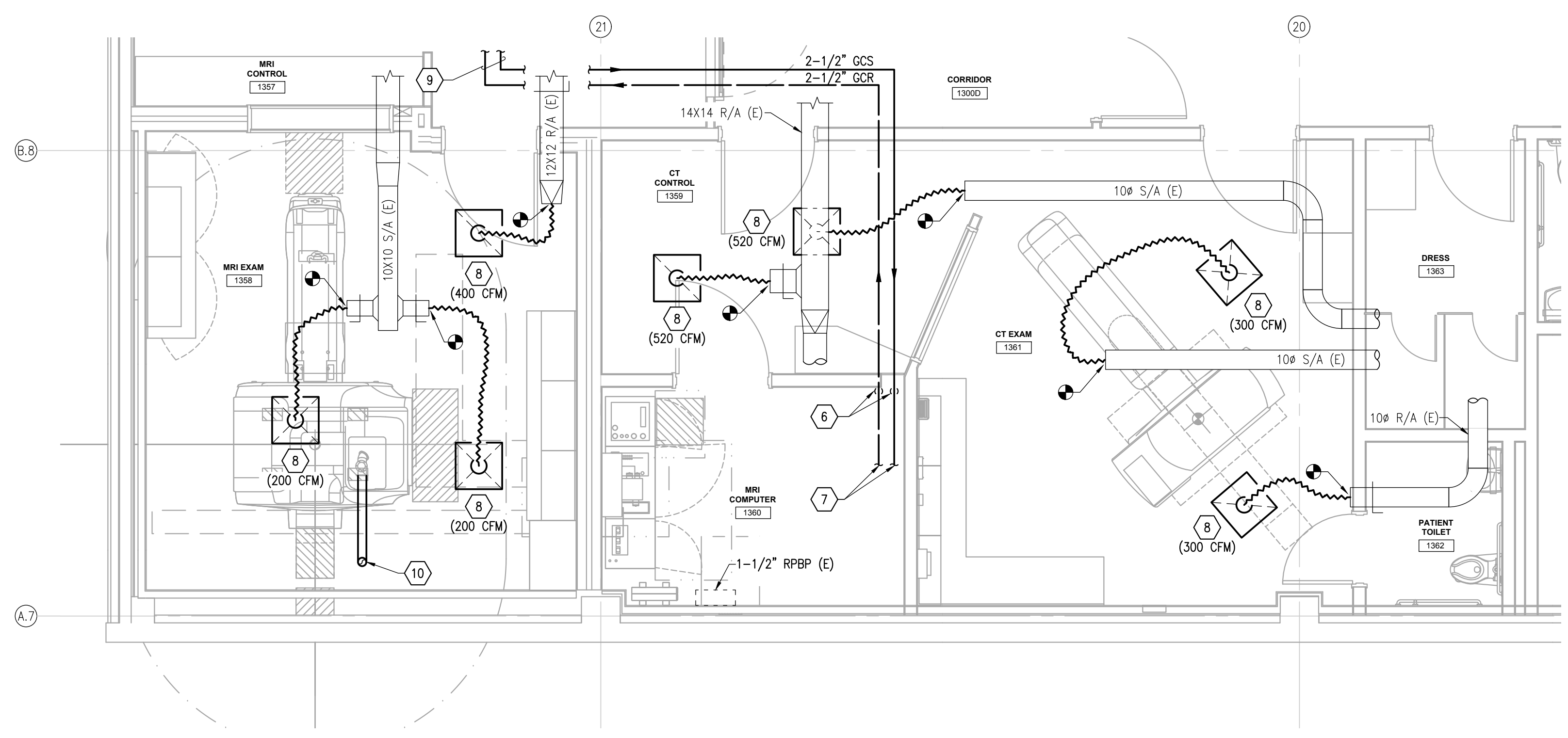

2 ENLARGED PLAN - MECHANICAL - CT RM 1361 AND MRI 1358 -NEW
 M202 SCALE: 1/4" = 1'-0"

- SHEET NOTES**
- 1 DEMOLISH CENTRAL CHILLED WATER PIPING AND DOMESTIC COLD WATER PIPING SERVING EXISTING MRI EQUIPMENT IN PREPARATION FOR INSTALLATION OF NEW CHILLED WATER SYSTEM.
 - 2 DEMOLISH EXTERIOR DRYCOOLER SERVING EXISTING CT EQUIPMENT AND ASSOCIATED CHILLED WATER PIPING AND POWER CONNECTION BACK TO SOURCE. PATCH EXTERIOR WALL TO MATCH EXISTING.
 - 3 REMOVE SUPPLY DIFFUSER AND RETURN GRILLE AND CLEAN FOR RE-INSTALLATION IN NEW CEILING. DEMOLISH FLEXIBLE DUCTING CONNECTED TO GRILLES AND DIFFUSERS. EXISTING RIGID DUCTWORK FROM VAV BOX TO REMAIN.
 - 4 1-1/2" REDUCED PRESSURE BACKFLOW PREVENTER SERVING AS A BACKUP COOLING SOURCE FOR MRI TO REMAIN.
 - 5 FLOOR SINK TO REMAIN.
 - 6 ROUTE 2" GCS/R PIPING DOWN TO MRI EQUIPMENT, SEE DIAGRAM 1/M601 FOR VALVING AND TERMINATION. SEE 2/M601 FOR MRI PIPING ELEVATION.
 - 7 ROUTE 1-1/2" GCS/R PIPING TO CT HEAT EXCHANGER, SEE DIAGRAM 1/M601 FOR VALVING AND TERMINATION.
 - 8 REINSTALL SUPPLY DIFFUSERS AND RETURN GRILLES IN NEW CEILING WITH NEW FLEXIBLE DUCTING CONNECTED TO EXISTING RIGID DUCTWORK, SEE 2/M602. BALANCE TO AIRFLOWS SHOWN.
 - 9 2-1/2" GCS/R. SEE 1/M101 FOR CONTINUATION.
 - 10 6" DIAMETER WELDED OR FLANGED 304 STAINLESS STEEL QUENCH VENT. UTILIZE THE EXISTING QUENCH VENT ROUTING TO ROUTE THE NEW VENT TO THE BUILDING EXTERIOR. TERMINATE THROUGH ROOF WITH RAIN CAP AND 3/8" MESH SCREEN.
 11. COORDINATE EXTENTS OF DEMOLITION WITH NEW WORK.
 12. EXISTING LINework TAKEN FROM EXISTING BUILDING AS-BUILT DRAWINGS AND LIMITED FIELD INVESTIGATION. FIELD VERIFY EXISTING CONDITIONS.
 13. SEE 4/M601 FOR TYPICAL PIPE AND DUCT INTERIOR WALL PENETRATION DETAIL.
 14. SEE 1/M602 FOR TYPICAL FLEXIBLE DUCT CONNECTION DETAIL.
 15. SEE 2/M602 FOR TYPICAL DUCT FITTING DETAIL.

Architects Alaska
 ARCHITECTS ALASKA
 AK Corp. Authorization AECC561
 900 W. 5th Avenue, Suite 403
 Anchorage, Alaska 99501-2029
 907.272.3567 907.277.1732 fax
 191 E. Swanson Avenue, Suite 203
 Wasilla, Alaska 99654-7025
 907.373.7503 907.376.3166 fax
 347 S. Ferguson Ave. Suite 3
 Bozeman, Montana 59715
 406.404.1588
 www.architectsalaska.com

AMC ENGINEERS
 www.amc-engineers.com
 Adams, Morgenthaler & Co., Inc.
 Co. No. C3342 - 907.257.9100
 701 E. Tudor Rd. Suite 250
 Anchorage, AK 99503

STATE OF ALASKA
 49TH
 Bart A. Semmler
 06/17/2022
 ME-13385
 REGISTERED PROFESSIONAL ENGINEER
 © 21339

City and Borough of Juneau
BARTLETT REGIONAL HOSPITAL MRI & CT REPLACEMENT
 3260 Hospital Dr. Juneau, AK 99801

Revisions		
No.	Description	Date

Drawn by ERP/MLJLZ	Date 06/17/2022
Checked BAS	Job No. 22008.01

Sheet Contents
 ENLARGED PLAN - MECHANICAL -
 CT RM 1361, MRI 1358 - DEMO AND
 NEW

Sheet No.
M202

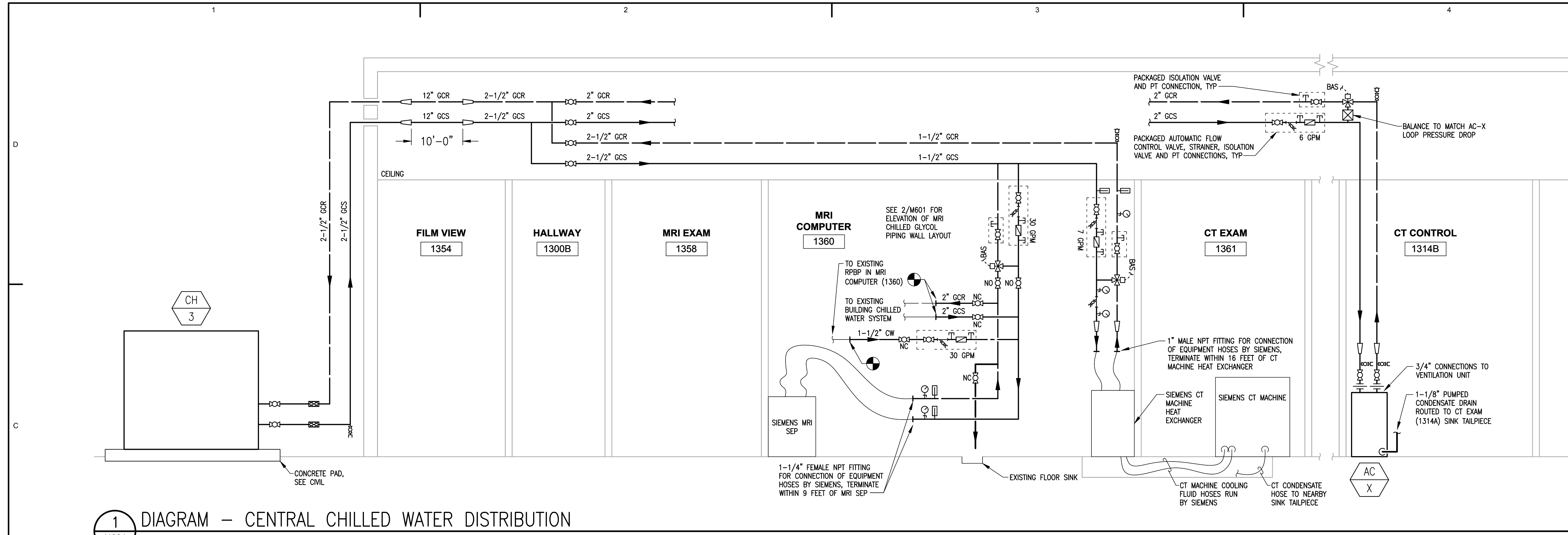

1 DIAGRAM – CENTRAL CHILLED WATER DISTRIBUTION
M601 SCALE: NONE

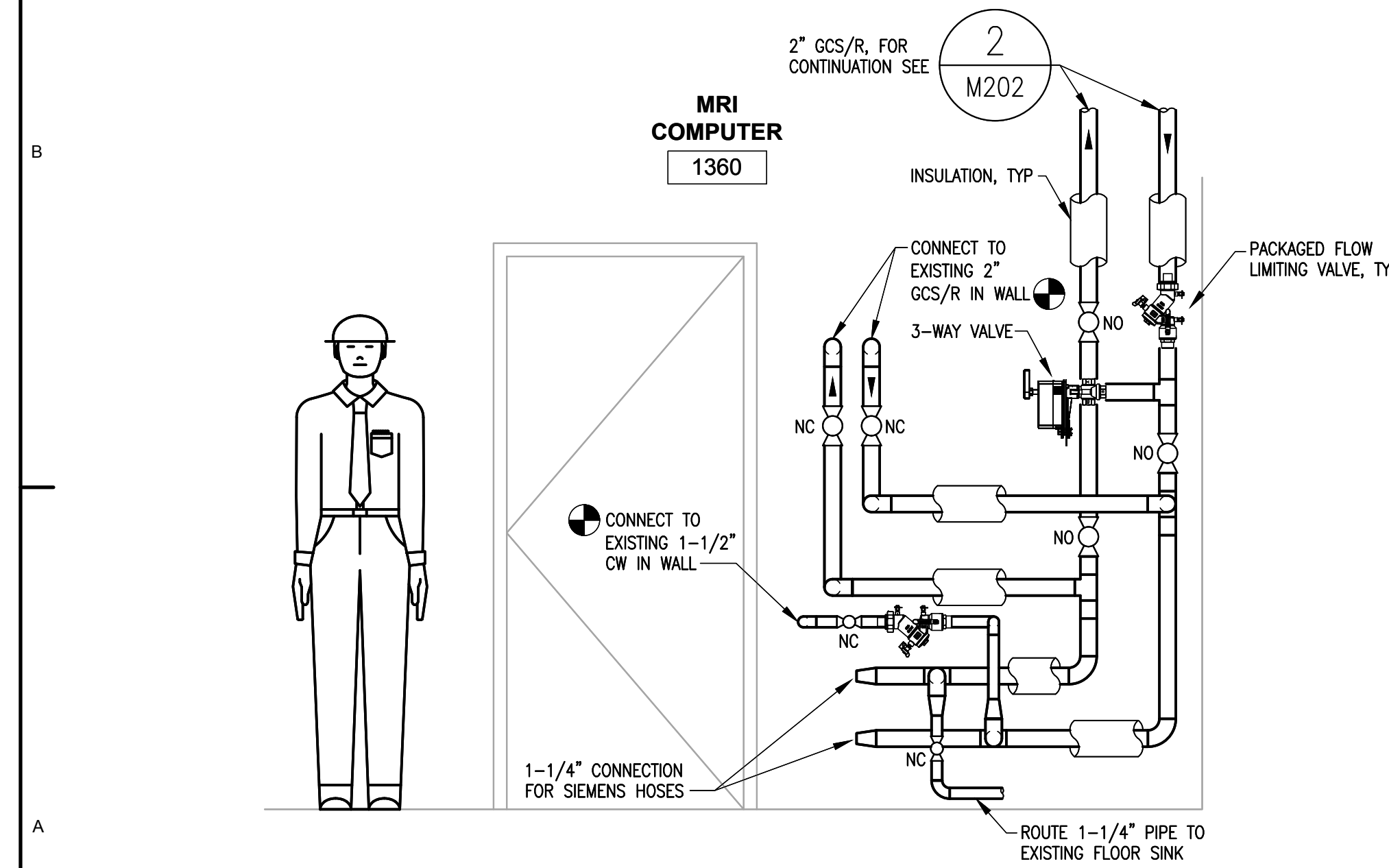

2 ELEVATION – MRI CHILLED WATER – NORTH
M601 SCALE: NONE

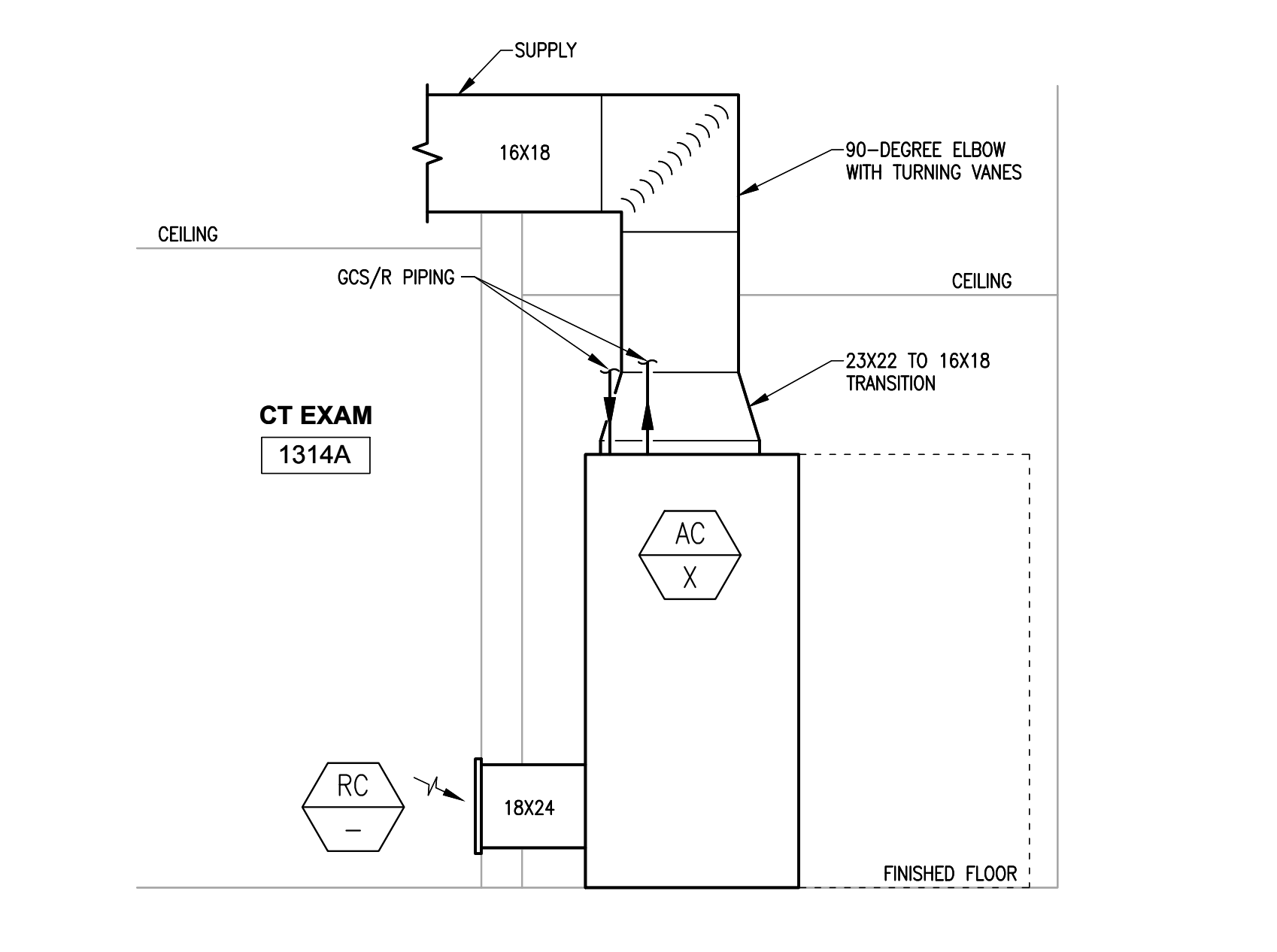

3 ELEVATION – CT 1314A FAN-COIL UNIT
M601 SCALE: NONE

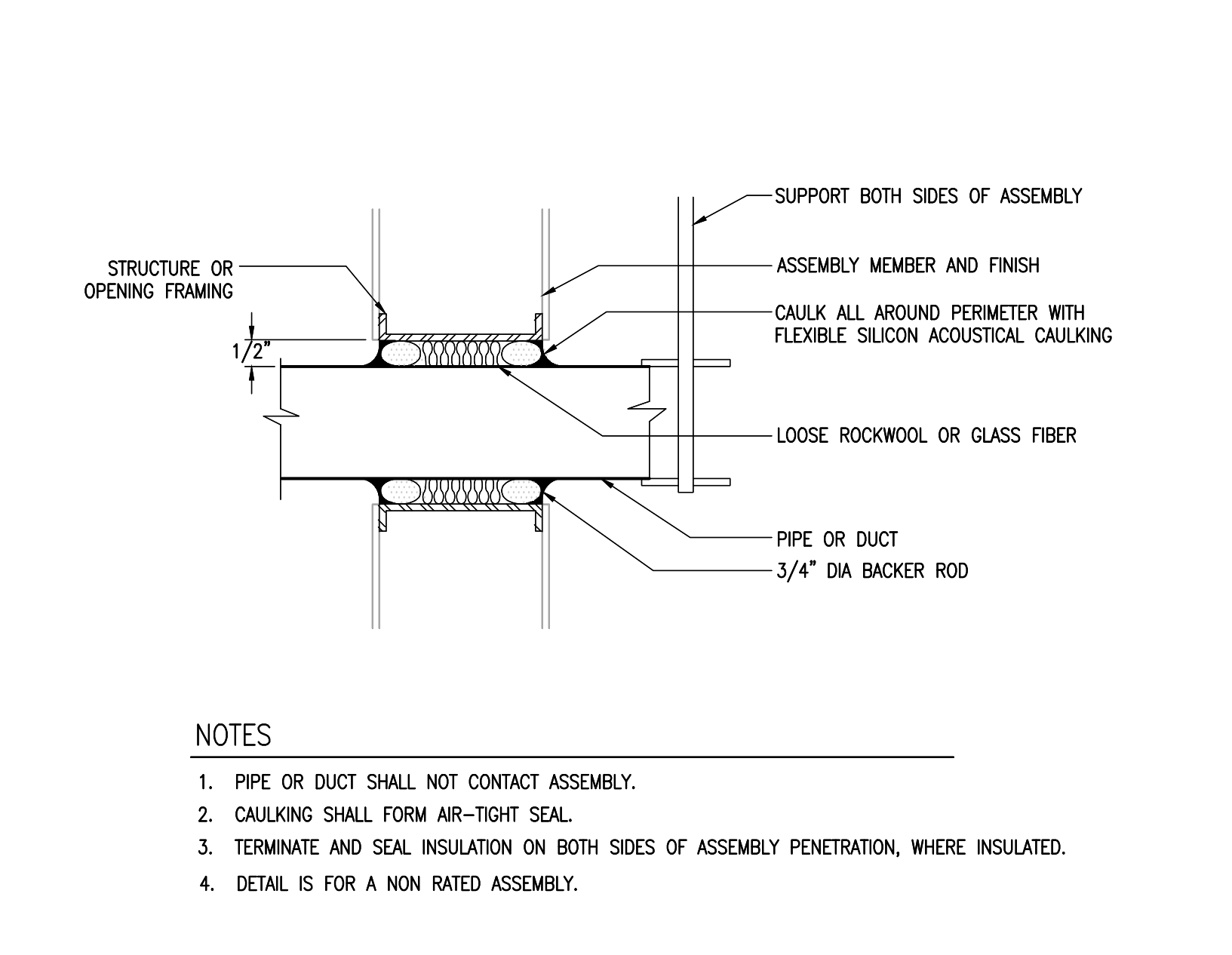

- NOTES**
- PIPE OR DUCT SHALL NOT CONTACT ASSEMBLY.
 - CAULKING SHALL FORM AIR-TIGHT SEAL.
 - TERMINATE AND SEAL INSULATION ON BOTH SIDES OF ASSEMBLY PENETRATION, WHERE INSULATED.
 - DETAIL IS FOR A NON RATED ASSEMBLY.

4 DETAIL – PIPE/DUCT INTERIOR WALL PENETRATION
M601 SCALE: NONE

Architects Alaska
ARCHITECTS ALASKA
AK Corp. Authorization AECC561
900 W. 5th Avenue, Suite 403
Anchorage, Alaska 99501-2029
907.272.3567 907.277.1732 fax
191 E. Swanson Avenue, Suite 203
Wasilla, Alaska 99654-7025
907.373.7503 907.376.3166 fax
347 S. Ferguson Ave. Suite 3
Bozeman, Montana 59715
406.404.1588
www.architectsalaska.com

AMC ENGINEERS
www.amc-engineers.com
Adams, Morgenthaler & Co., Inc.
COA No. C3342 - 907.257.9100
701 E. Tudor Rd. Suite 250
Anchorage, AK 99503

STATE OF ALASKA
49TH
Bart A. Semmler
06/17/2022
ME-13385
REGISTERED PROFESSIONAL ENGINEER
© 21339

City and Borough of Juneau
BARTLETT REGIONAL HOSPITAL MRI & CT REPLACEMENT
3260 Hospital Dr. Juneau, AK 99801

Revisions

No.	Description	Date

Drawn by ERP/ML/JLZ	Date 06/17/2022
Checked BAS	Job No. 22008.01

Sheet Contents
DETAILS AND DIAGRAMS

Sheet No.
M601

FILE NAME: x:\21339\hpmrct\Drawings\sheet files\21339 - M601.dwg
PLOTTED: jpbac 6/17/2022 12:47 PM

Revisions		
No.	Description	Date

Drawn by ERP/ML/JLZ	Date 06/17/2022
Checked BAS	Job No. 22008.01

Sheet Contents
DETAILS AND DIAGRAMS

Sheet No.
M602

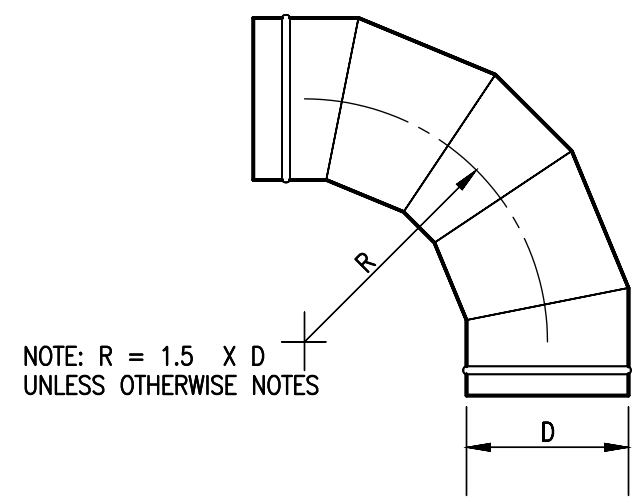

90 DEGREE ELBOW

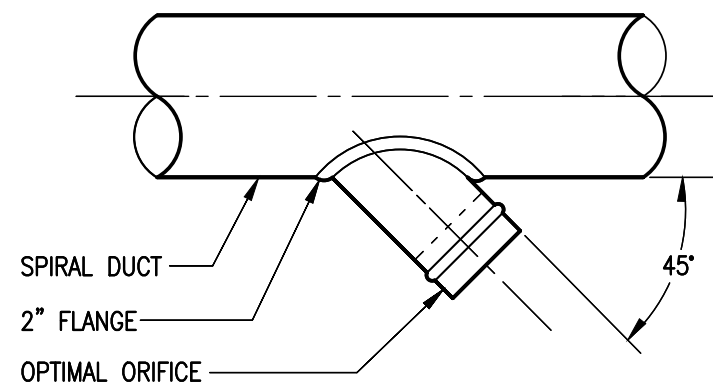

45 DEGREE TEE

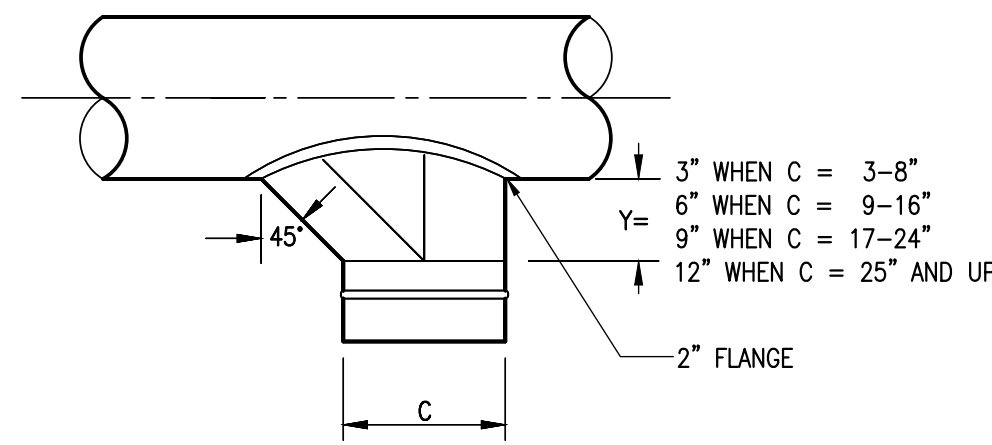

90 DEGREE TEE WITH OVAL

1 DETAIL - DUCT FITTINGS
M602 SCALE: NONE

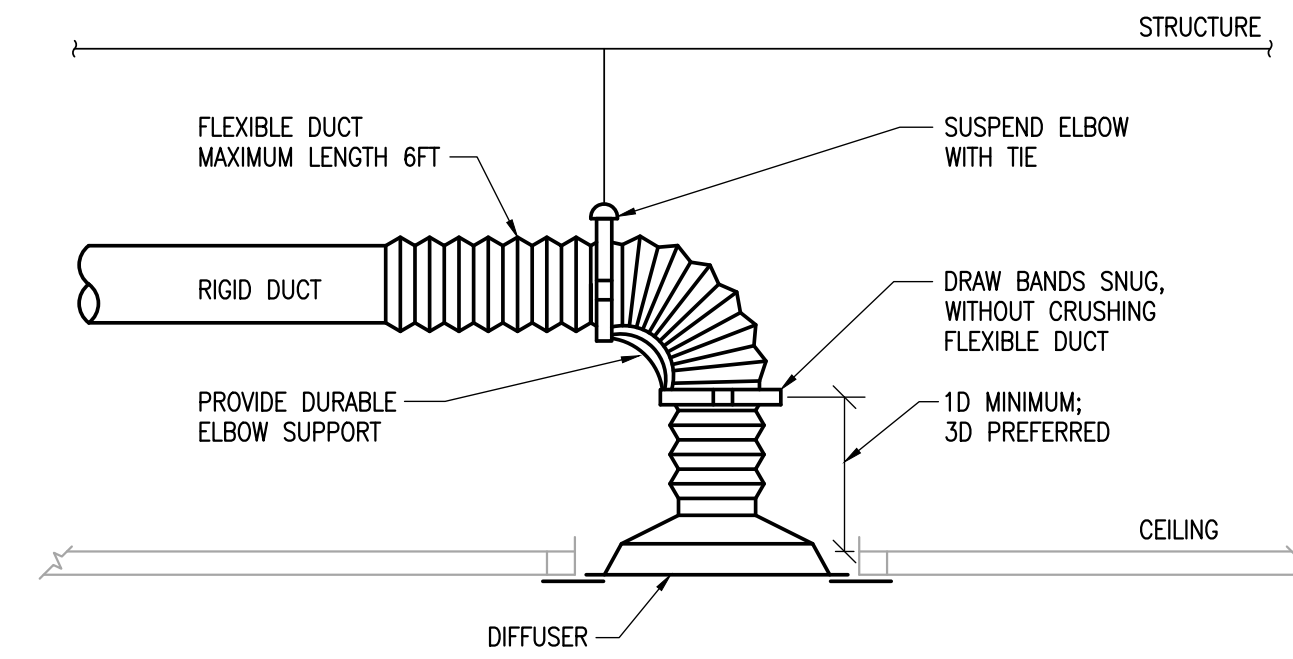

NOTES

1. WHEN LENGTH OF STRAIGHT DUCT UPSTREAM OF DIFFUSER IS LESS THAN 3D, PROVIDE AN EQUALIZING GRID.

2 DETAIL - FLEXIBLE DUCT CONNECTION
M602 SCALE: NONE

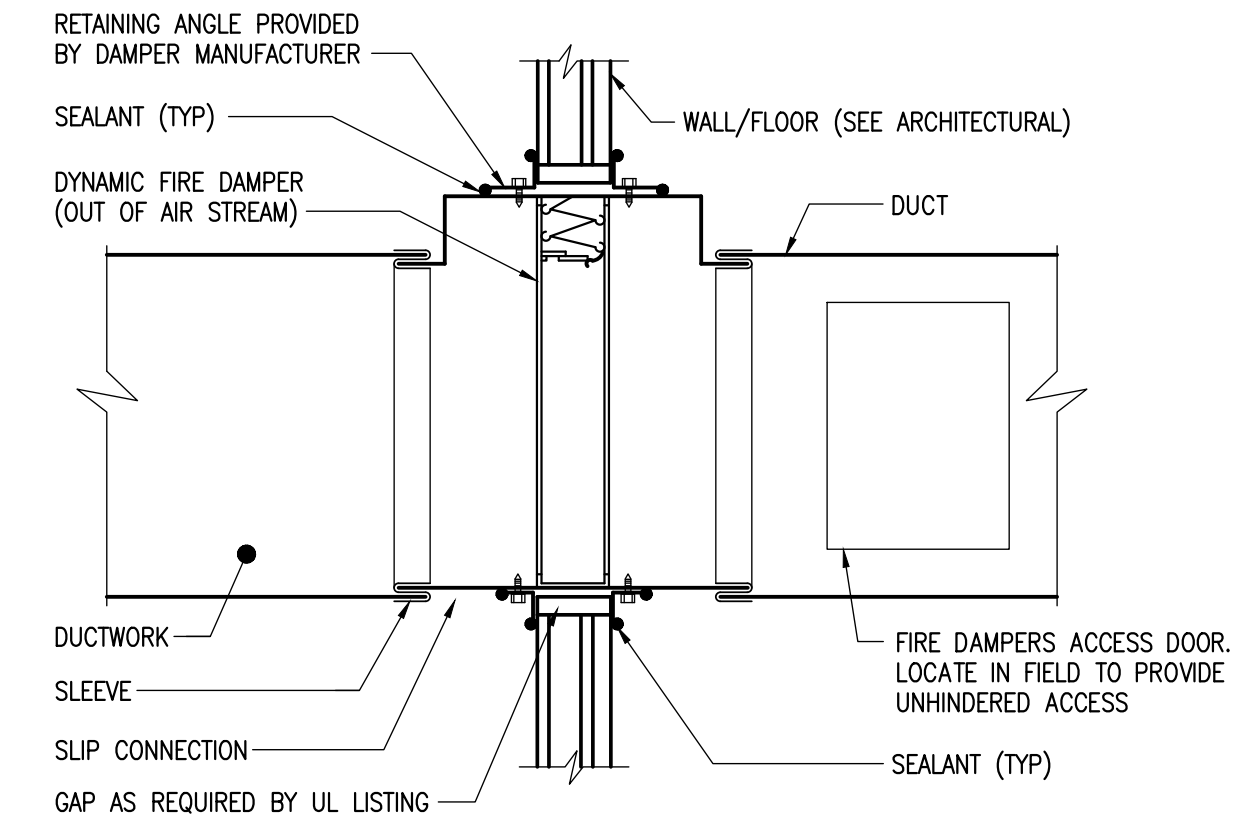

NOTES

1. PROVIDE FIRE DAMPER INSTALLATION IN ACCORDANCE WITH MANUFACTURER'S UL LISTING.
2. SEAL DUCT CONNECTIONS TO DAMPER WITH DUCT SEALANT.

3 DETAIL - FLEXIBLE DUCT CONNECTION
M602 SCALE: NONE

FILE NAME: X:\21339\BRH\NRC\Drawings\Sheet Files\21339 - E001.dwg
 PLOTTED: jpbac 6/17/2022 12:13 PM

1		2		3		4					
GENERAL		ABBREVIATIONS		POWER		LIGHTING		SPECIAL SYSTEMS		SPECIAL SYSTEMS	
SYMBOL	DESCRIPTION	SYMBOL	DESCRIPTION	SYMBOL	DESCRIPTION	SYMBOL	DESCRIPTION	SYMBOL	DESCRIPTION	SYMBOL	DESCRIPTION
	SHEET NOTE CONVENTION: REFERENCED SHEET NOTE GENERAL SHEET NOTE	ACS	ACCESS CONTROL SYSTEM		RECEPTACLE MOUNTING: RECEPTACLE - WALL MOUNTED (SEE "RECEPTACLE TYPES" BELOW)		LIGHTING FIXTURE		FIRE ALARM: MULTI-CANDELA HORN/STROBE - WALL MOUNTED		SECURITY: SECURITY GLASS BREAK DETECTOR - CEILING MOUNTED, WALL MOUNTED
	FEEDER IDENTIFICATION TAG FEEDER NUMBER DETAIL REFERENCE DETAIL NUMBER SHEET WHERE DETAIL APPEARS	AFG	ABOVE FINISHED FLOOR		RECEPTACLE - FLOOR MOUNTED (SEE "RECEPTACLE TYPES" BELOW)		LIGHTING FIXTURE - WALL MOUNTED		MULTI-CANDELA CHIME/STROBE - WALL MOUNTED		SECURITY INFRARED MOTION DETECTOR - LONG RANGE - WALL MOUNTED
	SECTION REFERENCE SECTION LETTER SHEET WHERE SECTION APPEARS	AL	ALUMINUM		RECEPTACLE - CEILING MOUNTED (SEE "RECEPTACLE TYPES" BELOW)		LIGHTING FIXTURE - PENDANT MOUNTED		MULTI-CANDELA CHIME/STROBE - CEILING MOUNTED		SECURITY INFRARED MOTION DETECTOR - 360° COVERAGE - CEILING MOUNTED
	REVISION SYMBOL	APPROX	APPROXIMATE		RECEPTACLE - CEILING MOUNTED DROP CORD (SEE "RECEPTACLE TYPES" BELOW)		LIGHTING FIXTURE - RECESS MOUNTED		MULTI-CANDELA STROBE - WALL MOUNTED		SECURITY INFRARED MOTION DETECTOR - 360° COVERAGE - CEILING MOUNTED
	LINE WORK CONVENTION: NEW OR REINSTALLED ITEM ITEM TO BE DEMOLISHED EXISTING ITEM TO REMAIN FUTURE ITEM EXISTING ITEM TO BE RELOCATED	C.O.	CONDUIT ONLY		RECEPTACLE TYPES: DUPEX RECEPTACLE		LIGHTING FIXTURE CONNECTED TO EMERGENCY POWER CIRCUIT		MULTI-CANDELA STROBE - CEILING MOUNTED		SECURITY - DOOR CONTACT
	CONDUIT/FEEDER LINE CONVENTION: CONCEALED UNDERGROUND OR CONCEALED IN FLOOR EXPOSED FLEXIBLE CONDUIT	CT	COMPUTED TOMOGRAPHY		DOUBLE DUPEX RECEPTACLE		LIGHTING FIXTURE CONNECTED TO EMERGENCY POWER CIRCUIT, NIGHT LIGHT		MULTI-CANDELA SPEAKER/STROBE		SECURITY - DOOR DEVICE (ELECTRONIC LOCK)
	LIGHT SWITCH CIRCUIT IDENTIFICATION LOWER CASE LETTER(S) INDICATES SWITCH LEG CIRCUITING CONVENTION CIRCUIT NUMBER(S) PANEL BRANCH CIRCUIT HOMERUN TO PANELBOARD NUMBER OF MARKS INDICATE NUMBER OF CONDUCTORS IN RACEWAY, NOT COUNTING GROUNDING CONDUCTORS. (ABSENCE OF MARKS INDICATE TWO CONDUCTORS, PLUS ANY REQUIRED GROUNDS) NUMBER OF ARROWS INDICATE NUMBER OF CIRCUITS UNSWITCHED CONDUCTORS SHOWN ON HOMERUN SIDE OF NEUTRAL NEUTRAL SWITCHED CONDUCTORS SHOWN ON LOAD SIDE OF NEUTRAL	CU	COPPER		GROUND FAULT INTERRUPTER, DUPEX RECEPTACLE		EXIT FIXTURE - WALL MOUNTED SHADED AREA(S) DENOTE FACE(S) OF SIGN, ARROWS AS NOTED (FIXTURE TYPE EX)		ELECTRONIC HORN AUDIBLE NOTIFICATION APPLIANCE		SECURITY - DOOR DEVICE (ELECTRONIC STRIKE)
	TYPICAL MOUNTING HEIGHTS SPECIAL OUTLET HEIGHTS ARE SHOWN ON THE ELECTRICAL DRAWINGS OR ON THE ARCHITECTURAL DRAWINGS. IF SPECIAL OUTLET HEIGHTS ARE NOT SHOWN OR REQUIRED, THEN LOCATE OUTLETS AS NOTED BELOW. OUTLET HEIGHTS ARE MEASURED FROM THE FINISHED FLOOR TO THE CENTERLINE OF THE OUTLET UNLESS OTHERWISE NOTED.	FA	FUTURE		DOUBLE DUPEX RECEPTACLE		EXIT FIXTURE - CEILING MOUNTED SHADED AREA(S) DENOTE FACE(S) OF SIGN, ARROWS AS NOTED (FIXTURE TYPE EX)		SSD SMOKE DETECTOR "PHOTO" SSD STANDARD DETECTOR BASE		REQUEST TO EXIT SENSOR
	RECEPTACLES 18 INCHES (460mm) VERTICALLY MOUNTED	FACP	FIRE ALARM ANNUNCIATOR		GROUND FAULT INTERRUPTER, DOUBLE DUPEX RECEPTACLE		EMERGENCY LIGHTING UNIT - WALL MOUNTED (FIXTURE TYPE XA)		PHOTOELECTRIC SMOKE DETECTOR W/ CARBON MONOXIDE SENSOR BASE		DELAYED EGRESS
	LIGHT SWITCHES 48 INCHES (1200mm) VERTICALLY MOUNTED	HAZ	HORSEPOWER		EMERGENCY POWER DUPLEX RECEPTACLE		EMERGENCY LIGHTING UNIT - CEILING MOUNTED (FIXTURE TYPE XA)		SSD HEAT DETECTOR "135" R.R. SSD STANDARD DETECTOR BASE		SECURITY - KEYPAD
	CLOCK OUTLET 80 INCHES (2030mm)	IAC	IN ACCORDANCE WITH		EMERGENCY POWER DOUBLE DUPEX RECEPTACLE		SITE LIGHTING - POLE MOUNTED		SSD HEAT DETECTOR, FIXED "194" STANDARD DETECTOR BASE		SECURITY - CARD READER
	PANELBOARDS 72 INCHES (1830mm) TO TOP OF PANELBOARD	K	KELVIN		EMERGENCY POWER GROUND FAULT INTERRUPTER, DUPEX RECEPTACLE		SINGLE POLE SWITCH		ADDRESSABLE 2-WIRE DUCT SENSOR		SECURITY - CAMERA (PAN/TILT/ZOOM)
	TELEPHONE OUTLET - DESK 18 INCHES (460mm) VERTICALLY MOUNTED	KVA	KILO VOLT-AMPS		EMERGENCY POWER GROUND FAULT INTERRUPTER, DOUBLE DUPEX RECEPTACLE		THREE-WAY SWITCH		REMOTE TEST STATION/KEY SWITCH		SECURITY - CAMERA (FIXED)
	TELEPHONE OUTLET - WALL 54 INCHES (1370mm) VERTICALLY MOUNTED	KW	KILOWATT		EMERGENCY POWER GROUND FAULT INTERRUPTER, DOUBLE DUPEX RECEPTACLE		FOUR-WAY SWITCH		MANUAL PULL STATION - SINGLE ACTION		SECURITY - HEADEND
	COMPUTER OUTLET - DESK 18 INCHES (460mm) VERTICALLY MOUNTED	MCC	MOTOR CONTROL CENTER		EMERGENCY POWER DOUBLE DUPEX RECEPTACLE		SWITCH FOR FIXTURES MARKED 'a',		FIRE ALARM REMOTE ANNUNCIATOR PANEL		NURSE CALL: DOME LIGHT - CEILING MOUNTED, WALL MOUNTED
	FIRE ALARM PULL STATION 48 INCHES (1200mm)	MCP	MOTOR CONTROL PANEL		EMERGENCY POWER GROUND FAULT INTERRUPTER, DOUBLE DUPEX RECEPTACLE		DIMMER SWITCH		CONTROL RELAY IAM MODULE		ZONE LIGHT - CEILING MOUNTED, WALL MOUNTED
	FIRE ALARM AUDIBLE NOTIFICATION DEVICE TOP EDGE NOT LESS THAN 90 INCHES (2300mm) AFF AND NOT LESS THAN 6 INCHES (150mm) BELOW CEILING. 6 INCHES (150mm) BELOW CEILING SHALL TAKE PRECEDENCE WHERE CEILING HEIGHT DOES NOT ALLOW BOTH DIMENSIONS	MDS	MAIN DISTRIBUTION SWITCHBOARD		EMERGENCY POWER GROUND FAULT INTERRUPTER, DOUBLE DUPEX RECEPTACLE		KEYED SWITCH		SINGLE INPUT MODULE		NURSE DUTY STATION
	FIRE ALARM VISUAL AND COMBINATION AUDIBLE/VISUAL NOTIFICATION DEVICE BOTTOM EDGE SHALL BE AT 80 INCHES (2030mm) AFF OR 6 INCHES (150mm) BELOW CEILING HEIGHT, WHICHEVER IS LOWER	MM	MULTIMODE FIBER OPTIC CABLE		EMERGENCY POWER GROUND FAULT INTERRUPTER, DOUBLE DUPEX RECEPTACLE		MOMENTARY SWITCH		DUAL INPUT MODULE		AUXILIARY INPUT JACKS
	FIRE ALARM CONTROL PANEL 72 INCHES (1830mm)	MTR	MAIN TELECOM ROOM		EMERGENCY POWER		OCCUPANCY SENSOR/SWITCH		COMBINATION WATERFLOW/TAMPER MODULE		EMERGENCY PULL CORD STATION
		NEC	NATIONAL ELECTRICAL CODE		EMERGENCY POWER RANGE RECEPTACLE - 50 AMP/250 VOLT		PILOT LIGHTED SWITCH		FIRE ALARM GRAPHIC MAP		PROGRAMMABLE BUTTON STATION
		NFPA	NATIONAL FIRE PROTECTION ASSOCIATION		POWER POLE		PHOTOCELL		DOOR HOLDER, 24/12 SEMI-FLUSH		PATIENT STATION - WALL STATION
		NL	NIGHT LIGHT		MOTOR		OCCUPANCY SENSOR - WALL MOUNTED		FIRE ALARM CONTROL PANEL (4100U)		PATIENT STATION - DOUBLE BED STATION
		NC	NORMALLY CLOSED		SWITCH - THERMAL TRIP WITH HEATER		OCCUPANCY SENSOR - CEILING MOUNTED		REMOTE BOOSTER POWER SUPPLY PANEL		BED STATION WITH CALL CORD IN LEIU OF PILLOW SPEAKER
		NO	NORMALLY OPEN		FUSED DISCONNECT		LOW VOLTAGE SWITCH(ES) FOR FIXTURES MARKED 'a', 'b', 'c' AS NOTED		PHOTOELECTRIC BEAM TRANSMITTER		PATIENT STATION - BED STATION
		N/A	NOT APPLICABLE		NON-FUSED DISCONNECT		KEYED LOW VOLTAGE SWITCH(ES) FOR FIXTURES MARKED 'a', 'b', 'c', ETC		PHOTOELECTRIC BEAM RECEIVER		CODE STATION - CODE BLUE
		NTS	NOT TO SCALE		COMBINATION STARTER/FUSED DISCONNECT				INDIVIDUAL MODULE		CODE STATION - CODE WHITE
		OFCI	OWNER FURNISHED, CONTRACTOR INSTALLED		STARTER OR CONTACTOR				SUPPRESSION RELEASING DEVICE		CODE STATION - CODE PINK
		OFOI	OWNER FURNISHED, OWNER INSTALLED		ENCLOSED CIRCUIT BREAKER				SUPERVISED INDIVIDUAL ADDRESSABLE MODULE		CODE STATION - CODE PURPLE
		PH	PHASE (ELECTRICAL)		JUNCTION BOX AND/OR CONNECTION TO EQUIPMENT				INDIVIDUAL ADDRESSABLE MODULE RELAY		CODE STATION - CODE PINK/PURPLE
		PMCS	POWER MONITORING CONTROL SYSTEM		VARIABLE SPEED DRIVE				BATTERY CABINET		CODE STATION - CODE BLUE/WHITE
		R	RELOCATED		PUSHBUTTON - SPECIAL				SOLENOID		MASTER STATION
		SMR	SURFACE MOUNTED RACEWAY		PANEL - SURFACE MOUNTED				FIRE SMOKE DAMPER		NURSE CALL HEADEND
		SPD	SPURGE PROTECTIVE DEVICE		PANEL - FLUSH MOUNTED				FLOW SWITCH		INFANT SECURITY: INFANT SECURITY - DOOR CONTACT
		TELECOM	TELECOMMUNICATION		ELECTRICAL EQUIPMENT				FLOW SWITCH		INFANT SECURITY - MAGNETIC LOCK
		TR	TELECOMMUNICATION ROOM		ELECTRICAL EQUIPMENT				TAMPER SWITCH		INFANT SECURITY - KEYPAD
		TYP	TYPICAL		TRANSFORMER				TAMPER SWITCH		INFANT SECURITY - POWER SUPPLY
		UON	UNLESS OTHERWISE NOTED						PRESSURE SWITCH		INFANT SECURITY - EXCITER
		VSD	VARIABLE SPEED DRIVE						PRESSURE SWITCH		INFANT SECURITY - LOCAL AREA RECEIVER
		VAC	VOLTS (ALTERNATING CURRENT)						END OF LINE DEVICE		INFANT SECURITY - NETWORK HUB
		VDC	VOLTS (DIRECT CURRENT)								INFANT SECURITY - CLIENT
		V	VOLTS OR VOLTAGE								INFANT SECURITY - CONTROLLER
		W	WAIT								
		WP	WEATHERPROOF								
		WG	WIRE GUARD								

CT 1314 - EQUIPMENT SCHEDULE				
TAG	EQUIPMENT DESCRIPTION	FURNISHED BY	INSTALLED BY	ADDITIONAL REQUIREMENTS/INFORMATION
B	GANTRY CABLE ACCESS	CONTRACTOR	CONTRACTOR	PROVIDE 12"x8" OPENING IN FD1 FLOOR DUCT COVER FOR GANTRY CABLING
DS	DOOR SAFETY SWITCH	NA	NA	PROVIDE DOOR POSITION SWITCH
ED1	SURFACE MOUNT DUCT	NA	NA	EXISTING TO REMAIN
EPO	EMERGENCY POWER OFF	CONTRACTOR	CONTRACTOR	MUSHROOM HEAD TYPE PUSH BUTTON WITH NC AND NO CONTACTS
FD1	TRENCH DUCT	CONTRACTOR	CONTRACTOR	12"x2.5" PROVIDE WITH DIVIDER AND WATERPROOF REMOVABLE COVERS
HD1	SURFACE MOUNT DUCT	CONTRACTOR	CONTRACTOR	10"x3.5"x3'-0" MOUNTED HORIZONTALLY ON WALL AT FLOOR LEVEL
ICS	IMAGE CONSTRUCTION SYSTEM	CONTRACTOR	CONTRACTOR	PROVIDE 12"x4" OPENING IN EXISTING ED1 FOR SIEMENS CABLE ROUTING
IN2	INJECTOR RECESSED DUCT	NA	NA	EXISTING TO REMAIN
IN3	INJECTOR PULL BOX	NA	NA	EXISTING TO REMAIN
MP	MAIN PANEL	CONTRACTOR	CONTRACTOR	REFER TO SHEET E601 FOR ADDITIONAL INFORMATION
POC	POWER DISTRIBUTION CABINET	SIEMENS	CONTRACTOR	PROVIDE 12"x5" OPENING IN EXISTING ED1 FOR SIEMENS CABLE ROUTING
RG	RESPIRATORY GATING	SIEMENS	SIEMENS	PROVIDE RECEPTACLE FOR CONNECTION TO RESPIRATORY GATE
SPD	SURGE SUPPRESSOR DEVICE	SIEMENS	CONTRACTOR	PROVIDE COVER FOR EXISTING JUNCTION BOX WITH 2" DIAMETER OPENING
VD1	VERTICAL DUCT	CONTRACTOR	CONTRACTOR	PROVIDE 10"x3.5" RACEWAY WITH REMOVABLE COVERS AND SURFACE MOUNT TO WALL EXTENDING FROM FLOOR TO CEILING. DIVIDE RACEWAY INTO TWO SECTIONS WITH METAL DIVIDER.
WL	WARNING LIGHT	NA	NA	EXISTING TO REMAIN

LIGHTING FIXTURE SCHEDULE					
TYPE	DESCRIPTION	COLOR TEMP	LUMENS	POWER (W)	MOUNTING
A	LITHONIA LDN6-35-LO6-WR-LS-MVOLT-EZ1 6" ROUND LED DOWNLIGHT, GENERAL ILLUMINATION LIGHTING, 80CRI, WHITE TRIM	3500K	750	9	RECESSED CEILING
B	GOTHAM EVO6-TUWH-RHYR/20-WRAMF-MD-MVOLT 6" ROUND LED TUNABLE WHITE DOWNLIGHT, MEDIUM LIGHT DISTRIBUTION, 80CRI, WHITE PAINTED ANTI-MICROBIAL FINISH	2700-6500K	2000	19	RECESSED CEILING
D	BALANCEDCARE BCTOR-22-4-TQ128-80-35-RE-W-UNV-DP 2'X2' LED TUNABLE WHITE IMAGE PANEL FIXTURE, 4-2X2 CONFIGURATION, REGRESSED, WHITE FINISH, 0-10V DIMMING	3500K	960 PER FIXTURE	33 PER FIXTURE	RECESSED CEILING

FIXTURE SCHEDULE NOTES	
1	REFER TO SPECIFICATION SECTION 26500 FOR ADDITIONAL REQUIREMENTS REGARDING LIGHT FIXTURES AND LED DRIVERS.

N41A1											
LOCATION: BG POWER 1303				VOLTS: 480/277 Wye				A.I.C. RATING: MATCH EXISTING			
FED FROM: MSB1				PHASES: 3				MAINS TYPE: LUGS			
MOUNTING: SURFACE				WIRES: 4				RATING: 400A			
CKT#	CIRCUIT DESCRIPTION	AMP	POLE	VA - PHASE A	VA - PHASE B	VA - PHASE C	POLE	AMP	CIRCUIT DESCRIPTION	CKT#	
1	LTG - RM 271B-2720,2801-2803,2806	20	1	3324	2770		1	20	LTG - IM DEPT 13: 01,02,05,06,37,42,44,54,56	2	
3	EPH - 4	20	3			3325 3324	1	20	LTG - ED DEPT RMS 1420 & 1433-36	4	
5						3325 2770	1	20	LTG - IMAGING DEPT & CORRIDORS	6	
7				3325			1	20	SPARE	8	
9	SPARE	20	1				1	20	SPARE	10	
11	SPARE	20	1				1	20	SPARE	12	
13	SPARE	20	1				1	20	SPARE	14	
15	SPARE	20	1				1	20	SPARE	16	
17	SPARE	20	1				1	20	SPARE	18	
19	SPARE	20	1				1	20	SPARE	20	
21	SPARE	20	1				1	20	SPARE	22	
23	SPARE	20	1				1	20	SPARE	24	
25	SPARE	20	1				3	15	AC-1, CT CONTROL RM 1314B	26	
27	SPARE	20	1	998		998				28	
29	SPARE	20	1			998				30	
31	X-RAY RF ROOM 1350	80	3	15500	22170		3	100	MRI	32	
33					15500	22170				34	
35					15500	22170				36	
37	MOBILE MRI (TEMPORARY)	150	3	50000	10087		3	225	PANEL N21A1	38	
39					50000	10087				40	
41						50000 10087				42	

PANEL	LOAD AMPS	PHASE A	PHASE B	PHASE C
		108.2 kVA	105.4 kVA	104.9 kVA
		391 A	381 A	379 A

LOAD TYPE	CONNECTED LOAD	DEMAND FACTOR	TOTAL LOAD WITH NEC FACTORS	PANEL TOTALS
CONTINUOUS	0 VA	125%	0	
LIGHTING	12188 VA	100%	12188	TOTAL CONNECTED LOAD: 318.4 kVA
MOTOR	12969 VA	119%	15462.75	TOTAL NEC LOAD: 320.9 kVA
NON-CONTINUOUS	293271 VA	100%	293271	TOTAL CONNECTED AMPS: 383.0 A
RECEPTACLE	0 VA	0%	0	TOTAL NEC AMPS: 386.0 A

NOTES:
1. EXISTING PANEL LOADS ARE ESTIMATED BASED ON AS-BUILT DRAWINGS AND LIMITED FIELD OBSERVATION.
2. BOLD TEXT INDICATES NEW LOAD AND CIRCUIT BREAKER PROVIDED UNDER THIS PROJECT

CT 1314 - CONDUIT AND CABLING SCHEDULE									
CABLE BANK	#	CONDUIT				CABLING			NOTES
		EXIST/NEW	FROM	TO	SIZE (IN.)	TYPE	FURNISHED BY	INSTALLED BY	
1	REQUIRES 1Ø 2 CONDUIT FROM MP TO EQ41C2.								
1	EXIST	MP	EQ41C2	2	5-#1/0 AWG	CONTRACTOR	CONTRACTOR		
2	REQUIRES 1Ø 1/2 INCH CONDUIT FROM MP TO EPO								
2	EXIST	MP	JBOX	1/2	3-#14 AWG	CONTRACTOR	CONTRACTOR		
3	REQUIRES 1Ø 1/2 INCH CONDUIT FROM EPO TO EPO								
3A	EXST	EPO	JBOX	1/2	5-#14 AWG	CONTRACTOR	CONTRACTOR		
3B	EXST	JBOX	JBOX	1/2	5-#14 AWG	CONTRACTOR	CONTRACTOR		
3C	NEW	JBOX	EPO	1/2	5-#14 AWG	CONTRACTOR	CONTRACTOR		
4	REQUIRES 1Ø 1/2 INCH CONDUIT FROM EPO TO VD1 (PDC)								
4	NEW	JBOX	VD1	1/2	3-#14 AWG	CONTRACTOR	CONTRACTOR		
5	REQUIRES 1Ø 3/4 INCH CONDUIT FROM MP TO SPD								
5	NEW	MP	SPD	1	5-#10 AWG	CONTRACTOR	CONTRACTOR	CABLE LENGTH SHALL BE LESS THAN 3'-0".	
6	REQUIRES 1Ø 1-1/2 INCH CONDUIT FROM MP TO VD1 (PDC)								
6	NEW	MP	VD1	1-1/2	5-#2 AWG	CONTRACTOR	CONTRACTOR		
7	REQUIRES 1Ø 1/2 INCH CONDUIT FROM VD1 (PDC) TO WARNING LIGHT								
7A	EXST	WL	JBOX	1/2	3-#14 AWG	CONTRACTOR	CONTRACTOR		
7B	NEW	JBOX	VD1	1/2	3-#14 AWG	CONTRACTOR	CONTRACTOR	SHARED PATHWAY WITH 8B.	
8	REQUIRES 1Ø 1/2 INCH CONDUIT FROM VD1 (PDC) TO DOOR SWITCH								
8A	NEW	DS	JBOX	1/2	3-#14 AWG	CONTRACTOR	CONTRACTOR		
8B	NEW	JBOX	VD1	1/2	2-#14 AWG	CONTRACTOR	CONTRACTOR	SHARED PATHWAY WITH 7B.	
9	REQUIRES 1Ø 2-1/2 INCH CONDUIT FROM IN2 TO IN3								
9	EXIST	IN2	IN3	2-1/2	EXISTING INJECTOR CABLING	EXISTING	CONTRACTOR		

NOTES:
1. CONDUIT BEND RADIUS SHALL NOT BE LESS THAN SIX TIMES THE DIAMETER OF THE CONDUIT. CONDUIT BENDS SHALL NOT EXCEED 270 DEGREES PER CABLE RUN.
2. CONDUIT RUN LENGTHS FOR SIEMENS SUPPLIED CABLES SHALL NOT EXCEED 75'-0".
3. FINAL POWER AND ROOM INTERCONNECTION SHALL BE MADE BY THE ELECTRICIAN.

N21A2											
LOCATION: ELECTRICAL ROOM #1303				VOLTS: 208/120 Wye				EXISTING PANEL			
FED FROM: N21A1				PHASES: 3				A.I.C. RATING: MATCH EXISTING			
MOUNTING: SURFACE				WIRES: 4				MAINS TYPE: CIRCUIT BREAKER			
								RATING: 225			
CKT#	CIRCUIT DESCRIPTION	AMP	POLE	VA - PHASE A	VA - PHASE B	VA - PHASE C	POLE	AMP	CIRCUIT DESCRIPTION	CKT#	
1	LTG - IMAGING GOWNING #1338	20	1	270	900		1	20	REC - RM 1323, 1338, 1350A, 1352, 1300C	2	
3	LTG - RM 1343, 1354, 1356	20	1		500 540		1	20	RM 1322, 1351, 1340A, 1300A	4	
5	LTG - IM DEPT RM 1307-1311	20	1			900	1	20	SPARE	6	
7	LTG - IM DEPT GOWN 1320, 1339	20	1	270	720		1	20	RM 1345, 1355	8	
9	SPARE	20	1			900	1	20	RM 1355	10	
11	LTG - IM DEPT MAMM US/ST 1313	20	1			900 1440	1	20	REC - RM 1300C, 1320, 1321	12	
13	LTG - IM DEPT NUC MED RM 1347	20	1	900	720		1	20	REC - RM 1322	14	
15	SPARE					540	1	20	RM 1321	16	
17	SPACE						1620	1	20	RM 1340	18
19	RM 1354, 1356	20	1	1080			1	20	SPARE	20	
21	RM 1356	20	1		1080 180		1	20	EQPMT - RM 1340 ULTRASOUND	22	
23	RM 1357, XRAY VIEW BOX	20	1			540 180	1	20	EQPMT REC - RM 1320	24	
25	REC - RM 1357	20	1	720 180			1	20	EQPMT REC - RM 1320	26	
27	REC - RM 1358	20	1		720 180		1	20	EQPMT REC - RM 1320	28	
29	EQPMT - RM 1354 XRAY VIEW PANELS	20	1			180 500	1	20	% REC-1314A RESP GATING-CT EXAM ROOM %	30	
31	EQPMT - NUC MED SECURITY SHUTTER	20	1	180 1000			1	20	% MRI EXAM ROOM DOOR GATE POWER %	32	
33	% REC - CH-3 (EXTERIOR) %	20	1		180 1200		1	20	% AUTO DOOR POWER - MRI CONTROL ROOM %	34	
35	SPARE	20	1			1200	1	20	% ACS DOOR POWER - MRI CONTROL ROOM %	36	
37	SPARE	20	1				1	20	SPARE	38	
39	SPARE	30	2				1	20	SPARE	40	
41							1	20	SPARE	42	

PANEL	LOAD AMPS	PHASE A	PHASE B	PHASE C
		6.9 kVA	6.0 kVA	7.5 kVA
		58 A	50 A	62 A

LOAD TYPE	CONNECTED LOAD	DEMAND FACTOR	TOTAL LOAD WITH NEC FACTORS	PANEL TOTALS
CONTINUOUS	0 VA	125%	0	
LIGHTING	0 VA	100%	0	TOTAL CONNECTED LOAD: 20.4 kVA
MOTOR	0 VA	0%	0	TOTAL NEC LOAD: 15.2 kVA
NON-CONTINUOUS	0 VA	100%	0	TOTAL CONNECTED AMPS: 56.7 A
RECEPTACLE	20420 VA	74%	15210	TOTAL NEC AMPS: 42.2 A

NOTES:
1. EXISTING PANEL LOADS ARE ESTIMATED BASED ON AS-BUILT DRAWINGS AND LIMITED FIELD OBSERVATION.
2. BOLD TEXT INDICATES NEW LOAD PROVIDED TO EXISTING SPARE CIRCUIT BREAKER UNDER THIS PROJECT
% PROVIDED UNDER MRI 1358 CONSTRUCTION
% PROVIDE UNDER CT RM 1314 CONSTRUCTION



ARCHITECTS ALASKA
AK Corp. Authorization AECC561
900 W. 5th Avenue, Suite 403
Anchorage, Alaska 99501-2029
907.272.3567 907.277.1732 fax
191 E. Swanson Avenue, Suite 203
Wasilla, Alaska 99654-7025
907.373.7503 907.376.3166 fax
347 S. Fergusion Ave. Suite 3
Bozeman, Montana 59715
406.404.1588
www.architectsalaska.com



ENGINEERS
www.amc-engineers.com
Adams, Morgenthaler & Co., Inc.
CoA No. C3342 - 907.257.9100
701 E. Tudor Rd., Suite 250
Anchorage, AK 99503



49TH
April S. Jordan
06/17/2022
EE-12624
REGISTERED PROFESSIONAL ENGINEER
© 21339

BARTLETT REGIONAL HOSPITAL MRI
 & CT REPLACEMENT
 3260 Hospital Dr. Juneau, AK 99801

Revisions		
No.	Description	Date

Drawn by ERP/MP/LJLZ	Date 06/17/2022
Checked ASJ	Job No. Project Number

Sheet Contents
SCHEDULES - CT RM 1314

Sheet No.
E002

FILE NAME: X:\21339\BPH\MRI\CT\Drawings\Sheet Files\21339 - E002.dwg
PLOTTED: jpbac 6/17/2022 12:13 PM

CT 1361 - EQUIPMENT SCHEDULE				
TAG	EQUIPMENT DESCRIPTION	FURNISHED BY	INSTALLED BY	ADDITIONAL REQUIREMENTS/INFORMATION
A3	HEAT EXCHANGER PULL BOX	NA	NA	EXISTING TO REMAIN
B	GANTRY CABLE ACCESS	CONTRACTOR	CONTRACTOR	PROVIDE 12"x24" PULL BOX MOUNTED FLUSH WITH FINISHED FLOOR
B1	COOLING HOSES ACCESS	CONTRACTOR	CONTRACTOR	
DS	DOOR SAFETY SWITCH	CONTRACTOR	CONTRACTOR	
ED1	SURFACE MOUNT DUCT	NA	NA	EXISTING TO REMAIN
EPO	EMERGENCY POWER OFF	CONTRACTOR	CONTRACTOR	MUSHROOM HEAD TYPE PUSH BUTTON WITH NC AND NO CONTACTS
F1	CARE VISION MONITOR	SIEMENS	CONTRACTOR	UTILIZE EXISTING PULLBOX
HD1	SURFACE MOUNT DUCT	CONTRACTOR	CONTRACTOR	10"x3.5"x3"-0" MOUNTED HORIZONTALLY ON WALL AT FLOOR LEVEL
ICS	IMAGE CONSTRUCTION SYSTEM	CONTRACTOR	CONTRACTOR	PROVIDE 12"x4" OPENING IN EXISTING ED1 FOR SIEMENS CABLE ROUTING
IRS	IMAGE RECONSTRUCTION SYSTEM	CONTRACTOR	CONTRACTOR	PROVIDE 8"x4" OPENING IN HD1
MP	MAIN PANEL	CONTRACTOR	CONTRACTOR	REFER TO SHEET E601 FOR ADDITIONAL INFORMATION
PDC	POWER DISTRIBUTION CABINET	SIEMENS	CONTRACTOR	PROVIDE 12"x5" OPENING IN EXISTING ED1 FOR SIEMENS CABLE ROUTING
SPD	SURGE SUPPRESSOR DEVICE	SIEMENS	CONTRACTOR	PROVIDE 4"x4" JUNCTION BOX WITH 2" OPENING IN COVER.
VD1	VERTICAL DUCT	CONTRACTOR	CONTRACTOR	PROVIDE 10"x3.5" RACEWAY WITH REMOVABLE COVERS AND SURFACE MOUNT TO WALL EXTENDING FROM FLOOR TO CEILING.
WL	WARNING LIGHT	NA	NA	EXISTING TO REMAIN
3DC	3D CAMERA	SIEMENS	CONTRACTOR	RELOCATE EXISTING 16"x16" PULLBOX

LIGHTING FIXTURE SCHEDULE					
TYPE	DESCRIPTION	COLOR TEMP	LUMENS	POWER (W)	MOUNTING
A	LITHONIA LDN6-35-LO6-WR-LS-MVOLT-EZ1 6" ROUND LED DOWNLIGHT, GENERAL ILLUMINATION LIGHTING, 80CRI, WHITE TRIM	3500K	750	9	RECESSED CEILING
B	GOTHAM EVO6-TLWH-RHYR/20-WRAMF-MD-MVOLT 6" ROUND LED TUNABLE WHITE DOWNLIGHT, MEDIUM LIGHT DISTRIBUTION, 80CRI, WHITE PAINTED ANTI-MICROBIAL FINISH	2700-6500K	2000	19	RECESSED CEILING
D	BALANCEDCARE BCTOR-22-4-TQ131-80-35-RE-W-UNV-DP 2'x2' LED TUNABLE WHITE IMAGE PANEL FIXTURE, 4-2X2 CONFIGURATION, REGRESSED, WHITE FINISH, 0-10V DIMMING	3500K	960 PER FIXTURE	33 PER FIXTURE	RECESSED CEILING
F	LITHONIA 2BLT4-40L-ADSM-EZ1-LP835 2'x4' LED TROFFER, SMOOTH REFLECTOR, CURVED SMOOTH DIFFUSER, 82CRI	3500K	4000	31	RECESSED CEILING

FIXTURE SCHEDULE NOTES	
1	REFER TO SPECIFICATION SECTION 26500 FOR ADDITIONAL REQUIREMENTS REGARDING LIGHT FIXTURES AND LED DRIVERS.

CT 1361 - CONDUIT AND CABLING SCHEDULE										
CABLE BANK	#	CONDUIT				CABLING				NOTES
		EXIST/NEW	FROM	TO	SIZE (IN.)	TYPE	FURNISHED BY	INSTALLED BY		
1	REQUIRES 1Ø 2	CONDUIT	FROM	MP	TO	CPBDP1				
1A	EXIST	JBOX	EQ41C2	2-1/2	5-#1/0 AWG	CONTRACTOR	CONTRACTOR			
1B	NEW	JBOX	MP	2	5-#1/0 AWG	CONTRACTOR	CONTRACTOR			
2	REQUIRES 1Ø 3/4	INCH CONDUIT	FROM	MP	TO	EPO				
2	NEW	MP	EPO	3/4	3-#12 AWG	CONTRACTOR	CONTRACTOR			
3	REQUIRES 1Ø 3/4	INCH CONDUIT	FROM	EPO	TO	EPO				
3	EXIST	EPO	EPO	3/4	5-#12 AWG	CONTRACTOR	CONTRACTOR			
4	REQUIRES 1Ø 3/4	INCH CONDUIT	FROM	EPO	TO	PDC				
4	NEW	EPO	PDC	3/4	3-#12 AWG	CONTRACTOR	CONTRACTOR		SHARED PATHWAY WITH 9.	
5	REQUIRES 1Ø 3/4	INCH CONDUIT	FROM	MP	TO	SPD				
5	NEW	MP	SPD	3/4	4-#10AWG + 1-#12 GRND	CONTRACTOR	CONTRACTOR		CABLE LENGTH SHALL BE LESS THAN 3'-0".	
6	REQUIRES 1Ø 1-1/2	INCH CONDUIT	FROM	MP	TO	PDC				
6	NEW	MP	PDC	1-1/2	4-#2 AWG + 1-#2 GRND	CONTRACTOR	CONTRACTOR			
7	REQUIRES 1Ø 3/4	INCH CONDUIT	FROM	PDC	TO	WL				
7	NEW	PDC	WL	3/4	2-#12AWG + 1-#12 GRND					
8	NOT USED									
9	REQUIRES 1Ø 3/4	INCH CONDUIT	FROM	PDC	TO	DS				
9	NEW	PDC	DS	3/4	2-#12AWG + 1-#12 GRND				SHARED PATHWAY WITH 4.	
10	NOT USED									
11	REQUIRES 2Ø 3	INCH CONDUITS	FROM	S4	TO	B1	(2) 3	COOLING HOSES	-	-
11	NEW	S4	B1							
12	NOT USED									
13	REQUIRES 1Ø 2-1/2	INCH CONDUIT	FROM	ICS	TO	F1	2-1/2	CONTROL CABLE	SIEMENS	SIEMENS
13	EXIST	ICS	F1	2-1/2	CONTROL CABLE	SIEMENS	SIEMENS			
14	REQUIRES 1Ø 2-1/2	INCH CONDUIT	FROM	PDC	TO	F1	2-1/2	POWER CABLE	SIEMENS	SIEMENS
14	NEW	PDC	F1	2-1/2	POWER CABLE	SIEMENS	SIEMENS			
15	NOT USED									
16	REQUIRES 1Ø 1	INCH CONDUIT	FROM	MP	TO	S4	1	3-#12AWG + 1-#12 GRND	CONTRACTOR	CONTRACTOR
16	NEW	MP	S4	1	3-#12AWG + 1-#12 GRND	CONTRACTOR	CONTRACTOR			
17	REQUIRES 1Ø 2-1/2	INCH CONDUIT	FROM	PDC	TO	3DC	2-1/2	POWER, GRND, DATA	SIEMENS	SIEMENS
17	NEW	PDC	3DC	2-1/2	POWER, GRND, DATA	SIEMENS	SIEMENS			
18	REQUIRES 3Ø 3	INCH CONDUITS	FROM	PDC	TO	B	(3) 3	POWER, DATA, FIBER	SIEMENS	SIEMENS
18	NEW	PDC	B	(3) 3	POWER, DATA, FIBER	SIEMENS	SIEMENS			
19	REQUIRES 1Ø 3	INCH CONDUIT	FROM	B	TO	ICS	3	CONTROL, DATA	SIEMENS	SIEMENS
19	NEW	B	ICS	3	CONTROL, DATA	SIEMENS	SIEMENS			
20	REQUIRES 1Ø 1-1/2	INCH CONDUIT	FROM	B	TO	IRS	1-1/2	DATA, FIBER	SIEMENS	SIEMENS
20	NEW	B	IRS	1-1/2	DATA, FIBER	SIEMENS	SIEMENS			

- NOTES
- CONDUIT BEND RADIUS SHALL NOT BE LESS THAN SIX TIMES THE DIAMETER OF THE CONDUIT. CONDUIT BENDS SHALL NOT EXCEED 270 DEGREES PER CABLE RUN.
 - CONDUIT RUN LENGTHS FOR SIEMENS SUPPLIED CABLES SHALL NOT EXCEED 75'-0".
 - FINAL POWER AND ROOM INTERCONNECTION SHALL BE MADE BY THE ELECTRICIAN.

Architects Alaska
ARCHITECTS ALASKA
 AK Corp. Authorization AECC561
 900 W. 5th Avenue, Suite 403
 Anchorage, Alaska 99501-2029
 907.272.3567 907.277.1732 fax
 191 E. Swanson Avenue, Suite 203
 Wasilla, Alaska 99654-7025
 907.373.7503 907.376.3166 fax
 347 S. Fergusson Ave. Suite 3
 Bozeman, Montana 59715
 406.404.1588
 www.architectsalaska.com

AMC ENGINEERS
 www.amc-engineers.com
 Adams, Morgenthaler & Co., Inc.
 C/O No. C3342 - 907.257.9100
 701 E. Tudor Rd. Suite 250
 Anchorage, AK 99503

STATE OF ALASKA
 49TH
 Aaron S. Jordan
 06/17/2022
 EE-12624
 REGISTERED PROFESSIONAL ENGINEER
 © 21339

City and Borough of Juneau
BARTLETT REGIONAL HOSPITAL MRI & CT REPLACEMENT
 3260 Hospital Dr. Juneau, AK 99801

Revisions		
No.	Description	Date

Drawn by ERP/MLJ/LZ	Date 06/17/2022
Checked ASJ	Job No. Project Number

Sheet Contents
 SCHEDULES - CT RM 1361

Sheet No.
E003

FILE NAME: X:\21339\BHM\BCT\Drawings\Sheet Files\21339 - E004.dwg
 PLOTTED: jpbac 8/17/2022 12:13 PM

MRI 1358 - EQUIPMENT SCHEDULE

TAG	EQUIPMENT DESCRIPTION	FURNISHED BY	INSTALLED BY	ADDITIONAL REQUIREMENTS/INFORMATION
AB	ALARM BOX	CONTRACTOR	CONTRACTOR	3" OPENING IN FACE OF VERTICAL DUCT 5'-0" AFF
EPC	ELECTRONICS CABINET	SIEMENS	SIEMENS	PROVIDE DROP OUT ON BOTTOM OF RACEWAY CD3 FOR CABLES. COORDINATE EXACT LOCATION WITH SIEMENS PROJECT MANAGER.
GPA	GRADIENT CABINET	SIEMENS	SIEMENS	PROVIDE DROP OUT ON BOTTOM OF RACEWAY CD3 FOR CABLES. COORDINATE EXACT LOCATION WITH SIEMENS PROJECT MANAGER.
SEP	SYSTEM SEPARATOR	SIEMENS	SIEMENS	PROVIDE DROP OUT ON BOTTOM OF RACEWAY CD3 FOR CABLES. COORDINATE EXACT LOCATION WITH SIEMENS PROJECT MANAGER.
B	MAGNET CABLE ACCESS	CONTRACTOR	CONTRACTOR	LOCATION FOR CABLES TO DROP OUT OF BOTTOM OF RACEWAY. COORDINATE EXACT LOCATION WITH SIEMENS PROJECT MANAGER.
EPO	EMERGENCY POWER OFF	CONTRACTOR	CONTRACTOR	
F1	SIEMENS RF FILTER PANEL	SIEMENS	CONTRACTOR	
MP	MAIN CIRCUIT BREAKER	CONTRACTOR	CONTRACTOR	PROVIDE ENCLOSED CIRCUIT BREAKER WITH SHUNT-TRIP FUNCTIONALITY AND ADJUSTABLE INSTANTANEOUS TRIP SETTING.
MRC	HOST COMPUTER	CONTRACTOR	CONTRACTOR	4"x4" OPENING IN FACE OF RACEWAY
MS	MAGNET STOP	CONTRACTOR	CONTRACTOR	PROVIDE NON-FERROUS SINGLE GANG BOX MOUNTED FLUSH WITH FINISHED WALL 6'-0" AFF. PROVIDE REMOVABLE COVER WITH CABLE EXIT
UPS	EATON 93PM UPS	CONTRACTOR	CONTRACTOR	CONDUIT LANDING PLATE ON UPS PER MANUFACTURER'S INSTRUCTIONS
CD1	CABLE TRAY	CONTRACTOR	CONTRACTOR	24" X 4" ALUMINUM LADDER TRAY. COORDINATE FINAL MOUNTING HEIGHT WITH SIEMENS PROJECT MANAGER. MAINTAIN 15" CLEARANCE BETWEEN CD1 AND FILTER PANEL F1. MAINTAIN 12" CLEARANCE BETWEEN CD1 AND CD2.
CD2	CABLE TRAY	CONTRACTOR	CONTRACTOR	12" X 4" ALUMINUM LADDER TRAY. COORDINATE FINAL MOUNTING HEIGHT WITH SIEMENS PROJECT MANAGER. MAINTAIN 15" CLEARANCE BETWEEN CD2 AND FILTER PANEL F1. MAINTAIN 12" CLEARANCE BETWEEN CD1 AND CD2.
CD3	CABLE TRAY	CONTRACTOR	CONTRACTOR	24" X 4" ALUMINUM LADDER TRAY. COORDINATE FINAL MOUNTING HEIGHT WITH SIEMENS PROJECT MANAGER. MAINTAIN 18" CLEARANCE BETWEEN CD1 AND FILTER PANEL F1.
HD1	HORIZONTAL DUCT	CONTRACTOR	CONTRACTOR	4" X 2" HORIZONTAL DUCT SURFACE MOUNTED ON WALL AT FLOOR LINE.
VD1	VERTICAL DUCT	CONTRACTOR	CONTRACTOR	24" X 4" VERTICAL DUCT MOUNTED FLUSH WITH FINISHED WALL FROM FLOOR LINE TO CEILING SPACE. PROVIDE REMOVABLE FINISHED COVERS.

LIGHTING FIXTURE SCHEDULE

TYPE	DESCRIPTION	COLOR TEMP	LUMENS	POWER (W)	MOUNTING
A	LITHONIA LDN6-35-L06-WR-LS-MVOLT-EZ1 6" ROUND LED DOWNLIGHT, GENERAL ILLUMINATION LIGHTING, 80CRI, WHITE TRIM	3500K	750	9	RECESSED CEILING
C	HEALTHCARE LIGHTING HCV322-G-MVOLT-SP1-D4-TA7834-DMTR2-GWAM 2'x2' LED MRI SUITE FIXTURE, NON-FERROMAGNETIC, CUSTOM IMAGE, 4-2X2 CONFIGURATION, GRID MOUNT, 0-10V DIMMING, ANTI-MICROBIAL WHITE FINISH	3500K	327 PER FIXTURE	40 PER FIXTURE	RECESSED CEILING
F	LITHONIA 2BLT4-40L-ADSM-EZ1-LP835 2'x4' LED TROFFER, SMOOTH REFLECTOR, CURVED SMOOTH DIFFUSER, 82CRI	3500K	4000	31	RECESSED CEILING
G	WILLIAMS M6PR-TL-L10-8TW-ATH-L-M-OF-WH-AM 6" ROUND LED MRI DOWNLIGHT, MED. DISTRIBUTION, AIRTIGHT CONSTRUCTION, FLUSH LENS, WHITE TEXTURE POWDER COAT. REMOTE DRIVER ENCLOSURE REQUIRED: MODEL #M6PR-R0BTW-11-L10-DIM-UNV	2700-5000K	1000	15	RECESSED CEILING

FIXTURE SCHEDULE NOTES

1 REFER TO SPECIFICATION SECTION 26500 FOR ADDITIONAL REQUIREMENTS REGARDING LIGHT FIXTURES AND LED DRIVERS.

MRI 1358 - CONDUIT AND CABLING SCHEDULE

CABLE BANK	EXIST/NEW	CONDUIT			CABLING			NOTES
		FROM	TO	SIZE (IN.)	TYPE	FURNISHED BY	INSTALLED BY	
1		REQUIRES 1Ø 2 CONDUIT FROM MP TO N41A1.						
1	EXIST	MP	N41A1	2	3-#1 AWG + 1-#1 GRND	CONTRACTOR	CONTRACTOR	
2		REQUIRES 1Ø 3/4 INCH CONDUIT FROM MP TO EPO						
2	NEW	MP	EPO	3/4	3-#12 AWG	CONTRACTOR	CONTRACTOR	
3		REQUIRES 1Ø 3/4 INCH CONDUIT FROM EPO TO EPO						
3	EXIST	EPO	EPO	3/4	5-#12 AWG	CONTRACTOR	CONTRACTOR	
4		REQUIRES 1Ø 2 INCH CONDUIT FROM MP TO EPC						
4	NEW	MP	EPC	2	3-#1 AWG + 1-#1 GRND	CONTRACTOR	CONTRACTOR	ROUTE CONDUCTORS IN EMT TO REDUCE ELECTROMAGNETIC INTERFERENCE.
5		REQUIRES 2Ø 2-1/2 INCH CONDUIT FROM VD1 (MRC) TO CD3 (EPC)						
5	NEW	VD1	CD3 (2)	2-1/2	--	SIEMENS	SIEMENS	
6		REQUIRES 1Ø 1-1/2 INCH CONDUIT FROM VD1 (AB) TO CD3 (EPC)						
6	NEW	VD1	CD3	1-1/2	--	SIEMENS	SIEMENS	
7		REQUIRES 1Ø 1/2 INCH CONDUIT FROM DS TO CD3 (EPC)						
7	NEW	VD1	CD3	1/2	--	SIEMENS	SIEMENS	
8		REQUIRES 1Ø 3/4 INCH CONDUIT FROM MS TO CD1 (MAGNET)						
8	NEW	MS	CD1	3/4	--	SIEMENS	SIEMENS	CONDUIT IN THE RF ROOM SHALL BE NON-FERROUS
9		REQUIRES 1Ø 3/4 INCH CONDUIT FROM EPO TO UPS						
9	NEW	EPO	UPS	3/4	3-#12 AWG	CONTRACTOR	CONTRACTOR	
10		REQUIRES 1Ø 2 INCH CONDUIT FROM UPS TO CD3 (EPC)						
10	NEW	UPS	CD3	2	--	SIEMENS	SIEMENS	

NOTES

- CONDUIT BEND RADIUS SHALL NOT BE LESS THAN SIX TIMES THE DIAMETER OF THE CONDUIT. CONDUIT BENDS SHALL NOT EXCEED 270 DEGREES PER CABLE RUN.
- CONDUIT RUN LENGTHS FOR SIEMENS SUPPLIED CABLES SHALL NOT EXCEED 60'-0".
- FINAL POWER AND ROOM INTERCONNECTION SHALL BE MADE BY THE ELECTRICIAN.

N21A2

EXISTING PANEL										
LOCATION: ELECTRICAL ROOM #1303					VOLTS: 208/120 Wye			AIC RATING: MATCH EXISTING		
FED FROM: N21A1					PHASES: 3			MAINS TYPE: CIRCUIT BREAKER		
MOUNTING: SURFACE					WIRES: 4			RATING: 225		
CKT#	CIRCUIT DESCRIPTION	AMP	POLE	VA - PHASE A	VA - PHASE B	VA - PHASE C	POLE	AMP	CIRCUIT DESCRIPTION	CKT#
1	LTG - IMAGING GOWNING #1338	20	1	270	900		1	20	REC - RM 1323, 1338, 1350A, 1352, 1300C	2
3	LTG - RM 1343, 1354, 1356	20	1		500	540	1	20	RM 1322, 1351, 1340A, 1300A	4
6	LTG - IM DEPT RM 1307-1311	20	1			900	1	20	SPARE	6
7	LTG - IM DEPT GOWN 1320, 1339	20	1	270	720		1	20	RM 1345, 1355	8
9	SPARE	20	1			900	1	20	RM 1355	10
11	LTG - IM DEPT MAMM US/ST 1313	20	1			900	1	20	REC - RM 1300C, 1320, 1321	12
13	LTG - IM DEPT NUC MED RM 1347	20	1	900	720		1	20	REC - RM 1322	14
15	SPACE					540	1	20	RM 1321	16
17	SPACE						1	20	RM 1340	18
19	RM 1354, 1356	20	1	1080			1	20	SPARE	20
21	RM 1356	20	1		1080	180	1	20	EQPMT - RM 1340 ULTRASOUND	22
23	RM 1357, XRAY VIEW BOX	20	1			540	1	20	EQPMT REC - RM 1320	24
25	REC - RM 1357	20	1	720	180		1	20	EQPMT REC - RM 1320	26
27	REC - RM 1358	20	1		720	180	1	20	EQPMT REC - RM 1320	28
29	EQPMT - RM 1354 XRAY VIEW PANELS	20	1			180	1	20	% REC-1314A RESP GATING-CT EXAM ROOM %	30
31	EQPMT - NUC MED SECURITY SHUTTER	20	1	180	1000		1	20	% MRI EXAM ROOM DOOR GATE POWER %	32
33	% REC - CH-3 (EXTERIOR) %	20	1		180	1200	1	20	% AUTO DOOR POWER - MRI CONTROL ROOM %	34
35	SPARE	20	1				1	20	% ACS DOOR POWER - MRI CONTROL ROOM %	36
37	SPARE	20	1				1	20	SPARE	38
39	SPARE	30	2				1	20	SPARE	40
41		--	--				1	20	SPARE	42

PANEL	LOAD AMPS	PHASE A	PHASE B	PHASE C
		6.9 kVA	6.0 kVA	7.5 kVA
		58 A	50 A	62 A

LOAD TYPE	CONNECTED LOAD	DEMAND FACTOR	TOTAL LOAD WITH NEC FACTORS	PANEL TOTALS	
CONTINUOUS	0 VA	125%	0	TOTAL CONNECTED LOAD: 20.4 kVA	TOTAL CONNECTED AMPS: 56.7 A
LIGHTING	0 VA	100%	0		
MOTOR	0 VA	0%	0		
NON-CONTINUOUS	0 VA	100%	0		
RECEPTACLE	20420 VA	74%	15210	TOTAL NEC AMPS: 42.2 A	

- NOTES:**
- EXISTING PANEL LOADS ARE ESTIMATED BASED ON AS-BUILT DRAWINGS AND LIMITED FIELD OBSERVATION.
 - BOLD TEXT INDICATES NEW LOAD PROVIDED TO EXISTING SPARE CIRCUIT BREAKER UNDER THIS PROJECT
- § PROVIDED UNDER MRI 1358 CONSTRUCTION
 % PROVIDED UNDER CT RM 1314 CONSTRUCTION

Architects Alaska
 ARCHITECTS ALASKA
 AK Corp. Authorization AECC561
 900 W. 5th Avenue, Suite 403
 Anchorage, Alaska 99501-2029
 907.272.3567 907.277.1732 fax
 191 E. Swanson Avenue, Suite 203
 Wasilla, Alaska 99654-7025
 907.373.7503 907.376.3166 fax
 347 S. Ferguson Ave. Suite 3
 Bozeman, Montana 59715
 406.404.1588
 www.architectsalaska.com

AMC ENGINEERS
 www.amc-engineers.com
 Adams, Morgenthaler & Co., Inc.
 CoA No. C3342 - 907.257.9100
 701 E. Tudor Rd. Suite 250
 Anchorage, AK 99503

STATE OF ALASKA
 49TH
 Aaron S. Jordan
 06/17/2022
 EE-12624
 REGISTERED PROFESSIONAL ENGINEER
 © 21339

City and Borough of Juneau
BARTLETT REGIONAL HOSPITAL MRI & CT REPLACEMENT
 3260 Hospital Dr. Juneau, AK 99801

Revisions

No.	Description	Date

Drawn by ERP/IMP/LJZ	Date 06/17/2022
Checked ASJ	Job No. Project Number

Sheet Contents
 SCHEDULES - MRI 1358

Sheet No.
E004

City and Borough of Juneau
**BARTLETT REGIONAL HOSPITAL MRI
& CT REPLACEMENT**
3260 Hospital Dr. Juneau, AK 99801

Revisions		
No.	Description	Date

Drawn by ERP/ML/JLZ	Date 06/17/2022
Checked ASJ	Job No. Project Number

Sheet Contents
SITE PLAN

Sheet No.
E100

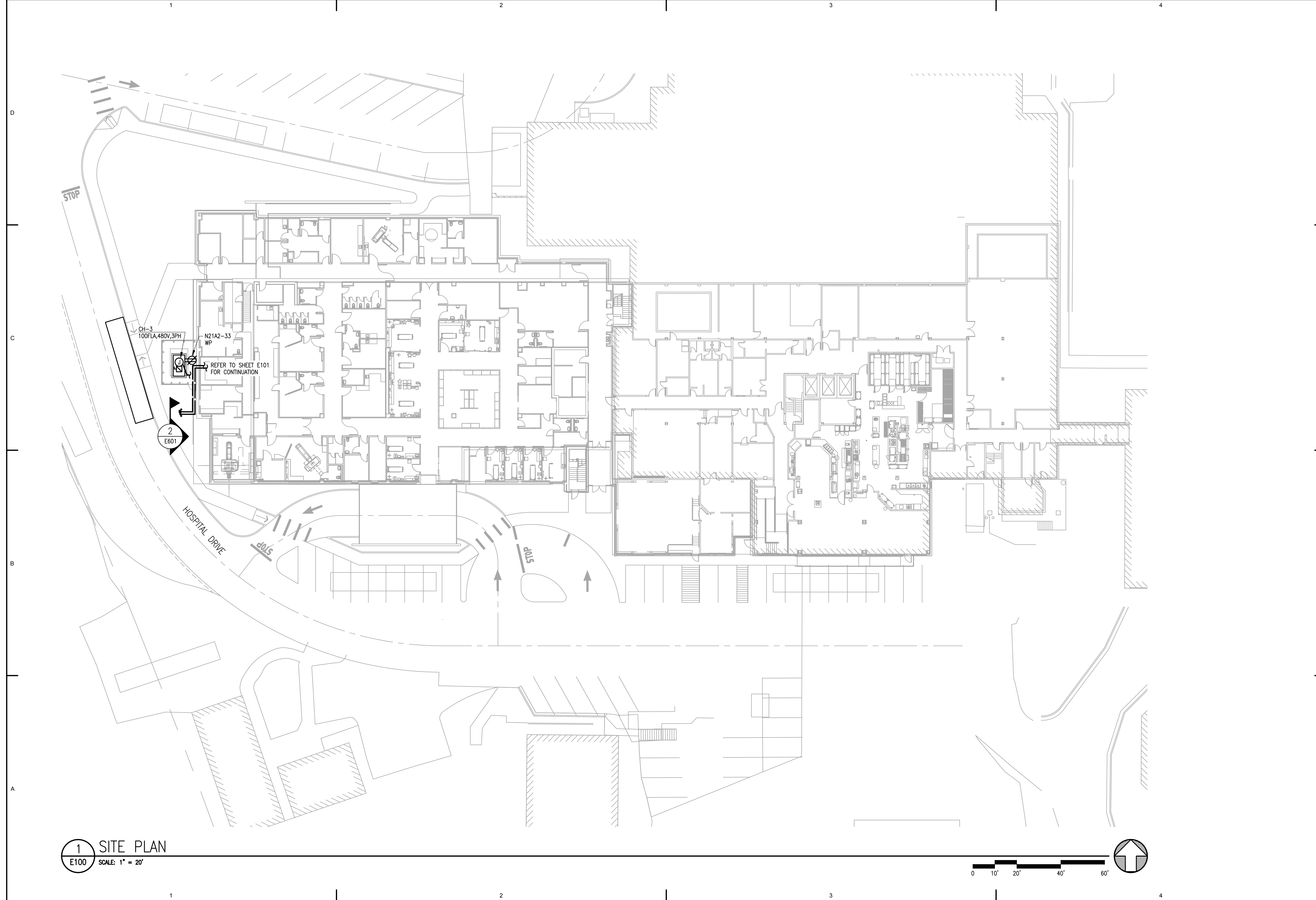

1 SITE PLAN
E100 SCALE: 1" = 20'

City and Borough of Juneau
**BARTLETT REGIONAL HOSPITAL MRI
& CT REPLACEMENT**
3260 Hospital Dr. Juneau, AK 99801

Revisions		
No.	Description	Date

Drawn by ERP/MP/LJLZ	Date 06/17/2022
Checked ASJ	Job No. Project Number

Sheet Contents
OVERALL PLAN

Sheet No.
E101



FILE NAME: s:\21339\hphmri\Drawings\Electrical\sheet files\21339 - E101.dwg
PLOTTED: epagulyan 7/11/2022 12:04 PM



FILE NAME: X:\21339\BRH\MRI\CT\Drawings\Sheet Files\21339 - E201.dwg
 PLOTTED: jpbac 8/17/2022 12:13 PM

BASE BID SHEET NOTES

- REMOVE EXISTING LIGHTING FIXTURES AND CEILING DEVICES AS REQUIRED FOR ROUTING OF ABOVE CEILING CONDUITS. STORE LIGHTING FIXTURES IN A SAFE PLACE DURING CONSTRUCTION. REINSTALL CEILING DEVICES AND FIXTURES AND RECONNECT TO EXISTING CIRCUITS ON COMPLETION OF ABOVE CEILING WORK.

ALTERNATE #1 SHEET NOTES

- DEMOLISH EXISTING LIGHTING FIXTURES AND DISPOSE OF PROPERLY. RETAIN EXISTING CIRCUIT FOR CONNECTION OF NEW LIGHTING FIXTURES.
- DEMOLISH EXISTING LIGHTING CONTROL SWITCH AND ASSOCIATED LIGHTING CONTROL ACCESSORIES.
- REMOVE EXISTING CEILING MOUNTED DEVICES TO ACCOMMODATE REPLACEMENT OF CEILING GRID. REINSTALL CEILING DEVICES AND RECONNECT TO EXISTING CIRCUITS UPON COMPLETION OF CEILING INSTALLATION.
- PROVIDE NEW LIGHTING FIXTURE AT LOCATION INDICATED VIA LIGHTING CONTROL SWITCH PROVIDED IAW SHEET NOTE 5 BELOW.
- PROVIDE LIGHTING CONTROL SWITCH AT LOCATION INDICATED FOR CONTROL OF ROOM LIGHTING. REFER TO DETAILS 3 AND 4 OF THIS SHEET FOR ADDITIONAL INFORMATION.
- CT CONTROL ROOM LIGHTING CONTROL SWITCH. PROVIDE ON/OFF AND DIMMING CONTROL OF TYPE "A" FIXTURES WITH APPROVED LITHONIA SWITCH MODEL# nPODMA-DX OR EQUIVALENT.
- CT EXAM ROOM LIGHTING CONTROL SWITCH. PROVIDE ON/OFF AND DIMMING CONTROL OF TYPE "D" FIXTURES WITH APPROVED LITHONIA SWITCH MODEL# nPODMA-DX OR EQUIVALENT.
- CT EXAM ROOM LIGHTING CONTROL SWITCH. PROVIDE ON/OFF, DIMMING, AND CCT TUNING CONTROL OF TYPE "B" FIXTURES WITH APPROVED LITHONIA SWITCH MODEL# nPODMA-2P-DX OR EQUIVALENT.
- EXISTING LIGHTING CIRCUIT SERVING THIS ROOM.
- REFER TO LIGHTING FIXTURE SCHEDULE ON SHEET E002 FOR LIGHTING FIXTURES ASSOCIATED WITH THIS SHEET.

Architects Alaska
 ARCHITECTS ALASKA
 AK Corp. Authorization AECC561
 900 W. 5th Avenue, Suite 403
 Anchorage, Alaska 99501-2029
 907.272.3567 907.277.1732 fax
 191 E. Swanson Avenue, Suite 203
 Wasilla, Alaska 99654-7025
 907.373.7503 907.376.3166 fax
 347 S. Ferguson Ave, Suite 3
 Bozeman, Montana 59715
 406.404.1588
 www.architectsalaska.com

AMC ENGINEERS
 www.amc-engineers.com
 Adams, Morgenthaler & Co., Inc.
 CoA No. C3342 - 907.257.9100
 701 E. Tudor Rd, Suite 250
 Anchorage, AK 99503

STATE OF ALASKA
 49TH
 Aaron S. Jordan
 06/17/2022
 EE-12624
 REGISTERED PROFESSIONAL ENGINEER
 © 21339

City and Borough of Juneau
BARTLETT REGIONAL HOSPITAL MRI & CT REPLACEMENT
 3260 Hospital Dr. Juneau, AK 99801

Revisions

No.	Description	Date

Drawn by ERP/ML/JLZ	Date 06/17/2022
Checked ASJ	Job No. Project Number

Sheet Contents
 ENLARGED PLAN - LIGHTING - CT RM 1314 - DEMO & NEW

Sheet No.
E201

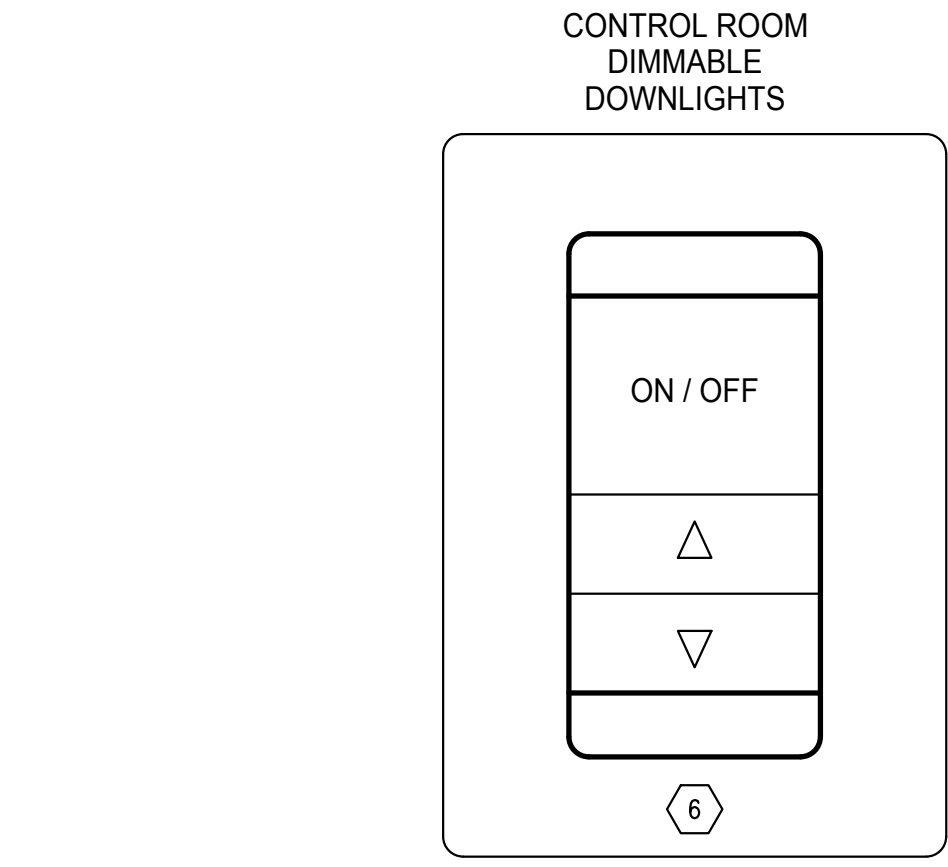

3 CONTROL ROOM - LIGHTING CONTROL
 E201 SCALE: NONE

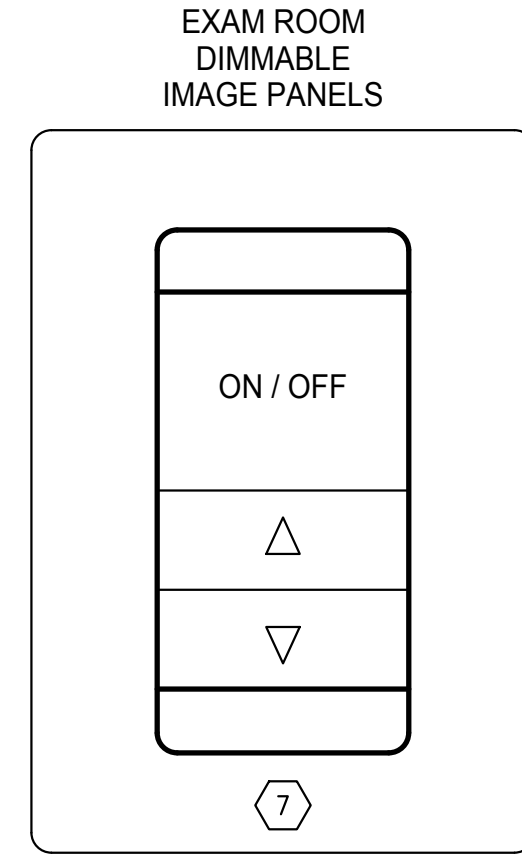

4 EXAM ROOM - LIGHTING CONTROL
 E201 SCALE: NONE

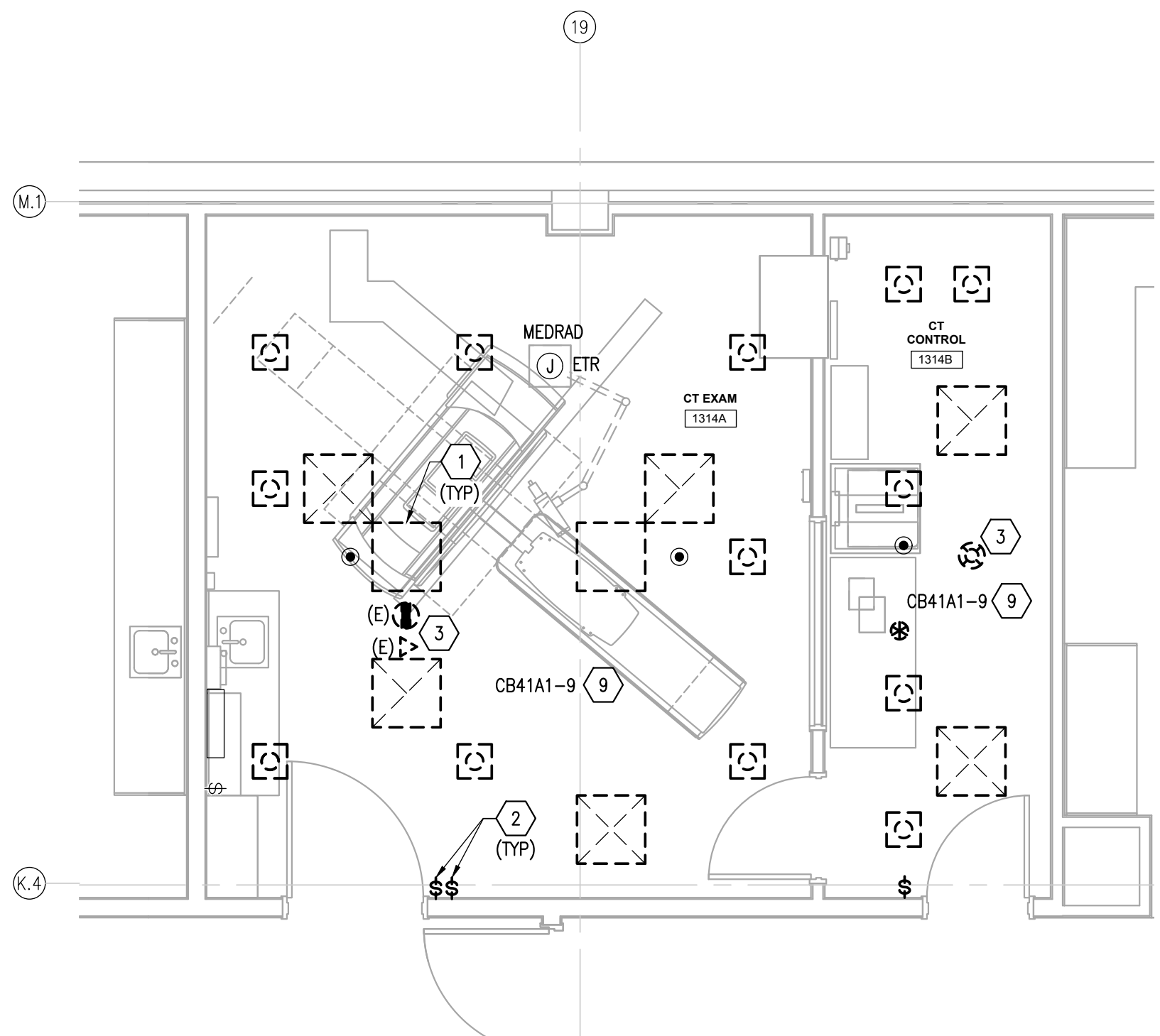
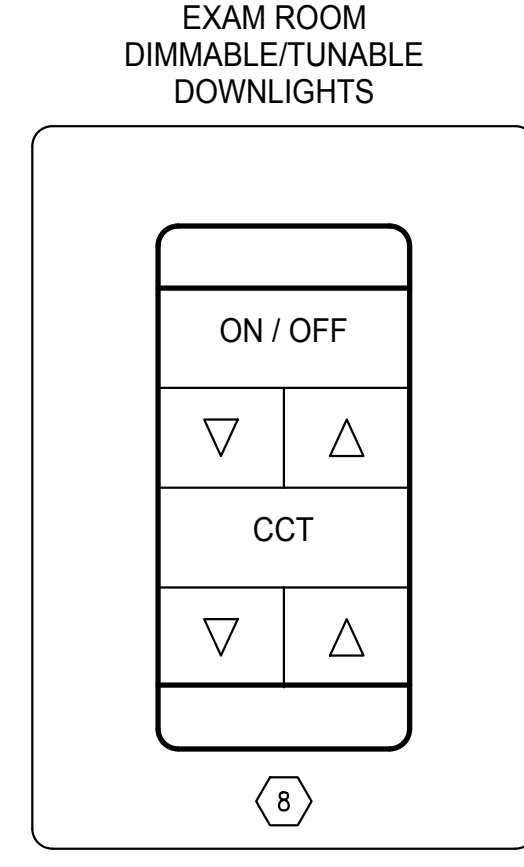

1 DEMOLITION PLAN - LIGHTING - CT RM 1314
 E201 SCALE: 1/4" = 1'-0"

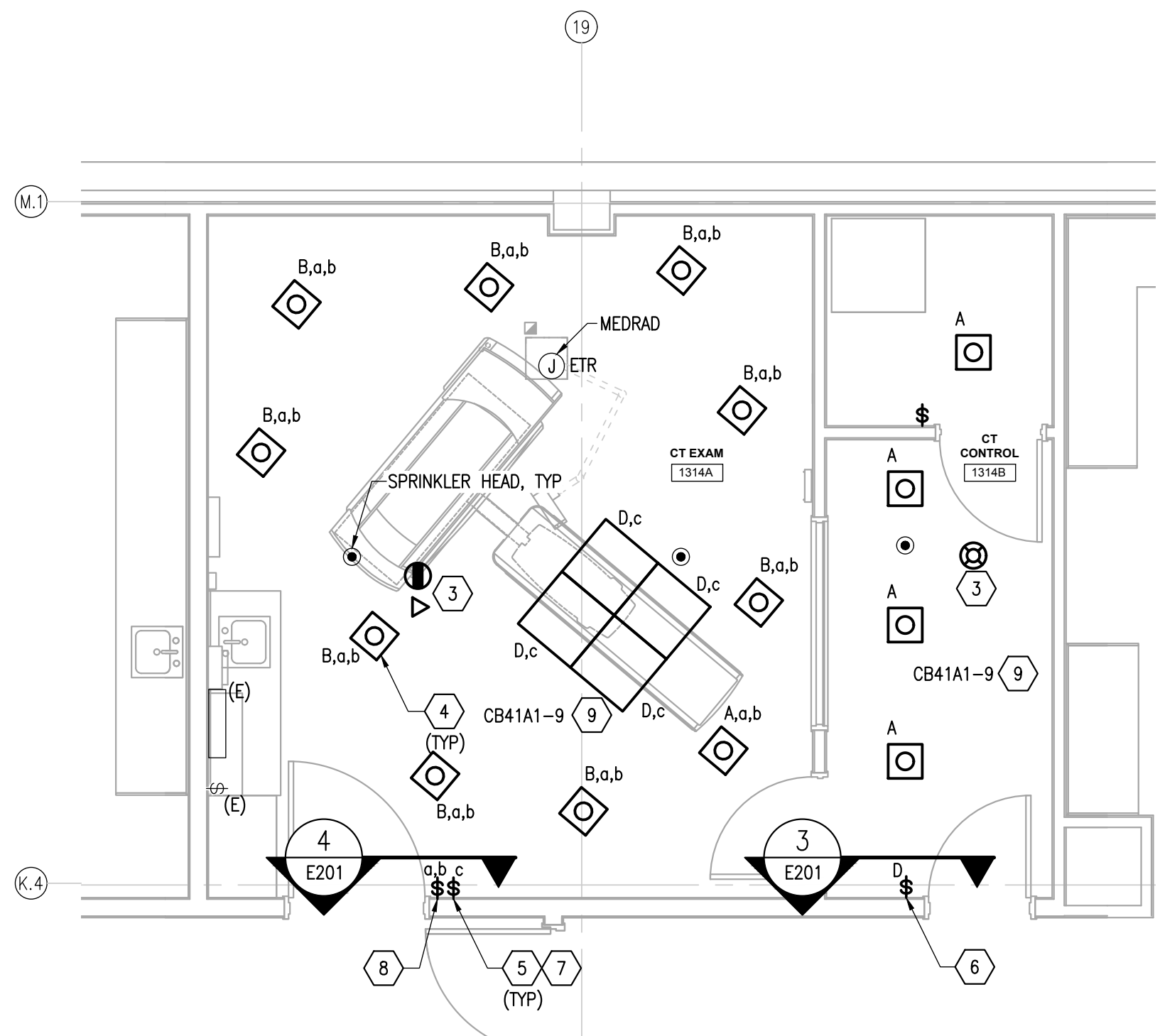

2 ENLARGED PLAN - LIGHTING - CT RM 1314 - NEW
 E201 SCALE: 1/4" = 1'-0"



FILE NAME: X:\21339\BPH\MRI\CT\Drawings\Sheet Files\21339 - E202.dwg
 PLOTTED: jpbac 8/17/2022 12:13 PM

- ### SHEET NOTES
- 1 DEMOLISH EXISTING PANEL AND ASSOCIATED CONDUCTORS. RETAIN EXISTING CONDUIT FOR REUSE IAW SHEET E203. REFER TO OVERALL PLAN ON SHEET E101 FOR APPROXIMATE CONDUIT ROUTING.
 - 2 SAW CUT CONCRETE SLAB AND TRENCH BASE MATERIAL AS REQUIRED TO FACILITATE INSTALLATION OF NEW TRENCH DUCT PROVIDED IAW SHEET E203.
 - 3 DEMOLISH EXISTING EMERGENCY STOP BUTTONS AND ASSOCIATED CONDUCTORS. RETAIN EXISTING BACK BOXES AND CONDUIT FOR REUSE IAW SHEET E203.
 - 4 DEMOLISH EXISTING FLOOR TRENCH. SAW CUT CONCRETE SLAB AND TRENCH BASE MATERIAL AS REQUIRED TO ALLOW FOR INSTALLATION OF NEW FLOOR TRENCH PROVIDED IAW SHEET E203.

Architects Alaska
 ARCHITECTS ALASKA
 AK Corp. Authorization AECC561
 900 W. 5th Avenue, Suite 403
 Anchorage, Alaska 99501-2029
 907.272.3567 907.277.1732 fax
 191 E. Swanson Avenue, Suite 203
 Wasilla, Alaska 99654-7025
 907.373.7503 907.376.3166 fax
 347 S. Ferguson Ave. Suite 3
 Bozeman, Montana 59715
 406.404.1588
 www.architectsalaska.com

AMC ENGINEERS
 www.amc-engineers.com
 Adams, Morgenthaler & Co., Inc.
 CoA No. C3342 - 907.257.9100
 701 E. Tudor Rd. Suite 250
 Anchorage, AK 99503

STATE OF ALASKA
 49TH
 Aaron S. Jordan
 06/17/2022
 EE-12624
 REGISTERED PROFESSIONAL ENGINEER
 © 21339

City and Borough of Juneau
**BARTLETT REGIONAL HOSPITAL MRI
 & CT REPLACEMENT**
 3260 Hospital Dr. Juneau, AK 99801

Revisions		
No.	Description	Date

Drawn by ERP/MLJ/LZ	Date 06/17/2022
Checked ASJ	Job No. Project Number

Sheet Contents
 ENLARGED PLAN - POWER &
 SPECIAL SYSTEMS - CT RM 1314 -
 DEMO

Sheet No.
E202

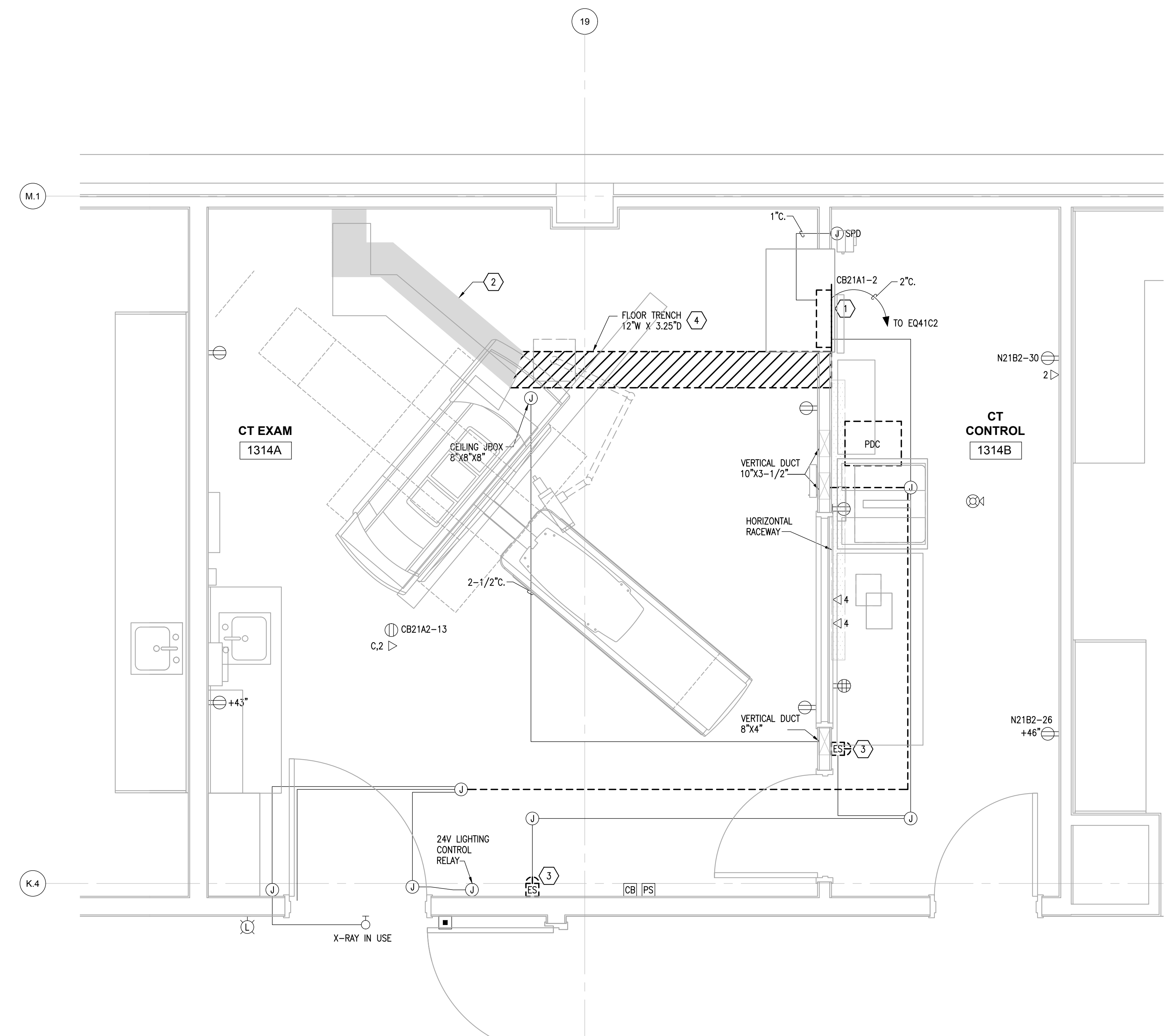

1 ENLARGED PLAN - POWER & SPECIAL SYSTEMS - CT RM 1314 - DEMO
 E202 SCALE: 1/2" = 1'-0"

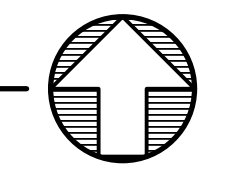

FILE NAME: X:\21339\BPH\MRI\CT\Drawings\Sheet Files\21339 - E203.dwg
 PLOTTED: jpbac 8/17/2022 12:13 PM

- ### SHEET NOTES
- 1 PROVIDE MAIN CT PANEL AT LOCATION INDICATED IAW WITH POWER ONE-LINE DIAGRAM ON SHEET E701. REFER TO OVERALL PLAN ON SHEET E101 FOR APPROXIMATE CONDUIT ROUTING.
 - 2 PROVIDE TRENCH DUCT AT LOCATION INDICATE. MOUNT DUCT FLUSH WITH FINISHED FLOOR. REMOVABLE WATERPROOF COVERS SHALL BE FINISHED WITH IDENTICAL MATERIAL AS SURROUNDING FLOORING.
 - 3 PROVIDE EMERGENCY SHUTDOWN BUTTONS AND ASSOCIATED CABLING AND CONNECTIONS IAW POWER ONE-LINE DIAGRAM ON SHEET E701.
 - 4 PROVIDE ELECTRICAL CONNECTION TO AC-1. REFER TO MECHANICAL DRAWINGS FOR ADDITIONAL INFORMATION.
 - 5 REUSE EXISTING CABLE PATHWAYS TO THE GREATEST EXTENT PRACTICAL.
 - 6 PROVIDE 12"x5" OPENING IN RACEWAY AT LOCATION SHOWN.
 - 7 PROVIDE NEW RECEPTACLE FOR RESPIRATORY GATING MOBILE CART AT LOCATION SHOWN, CONNECT TO CIRCUIT NOTED.
 - 8 REFER TO EQUIPMENT SCHEDULE AND CONDUIT & CABLING SCHEDULE ON SHEET E002 FOR ADDITIONAL INFORMATION.
 - 9 REFER TO SIEMENS FURNISHED LITERATURE FOR ADDITIONAL INSTALLATION REQUIREMENTS. FULLY COORDINATE WORK WITH BOTH THESE CONTRACT DOCUMENTS AND SIEMENS LITERATURE, NOTIFY OWNER OF ANY DISCREPANCIES IMPACTING INSTALLATION AS INDICATED.

**Architects
Alaska.**

ARCHITECTS ALASKA
 AK Corp. Authorization AECC561
 900 W. 5th Avenue, Suite 403
 Anchorage, Alaska 99501-2029
 907.272.3567 907.277.1732 fax

191 E. Swanson Avenue, Suite 203
 Wasilla, Alaska 99654-7025
 907.373.7503 907.376.3166 fax

347 S. Ferguson Ave. Suite 3
 Bozeman, Montana 59715
 406.404.1588
 www.architectsalaska.com

**AMC
ENGINEERS**

www.amc-engineers.com
 Adams, Morgenthaler & Co., Inc.
 CoA No. C3342 - 907.257.9100
 701 E. Tudor Rd. Suite 250
 Anchorage, AK 99503

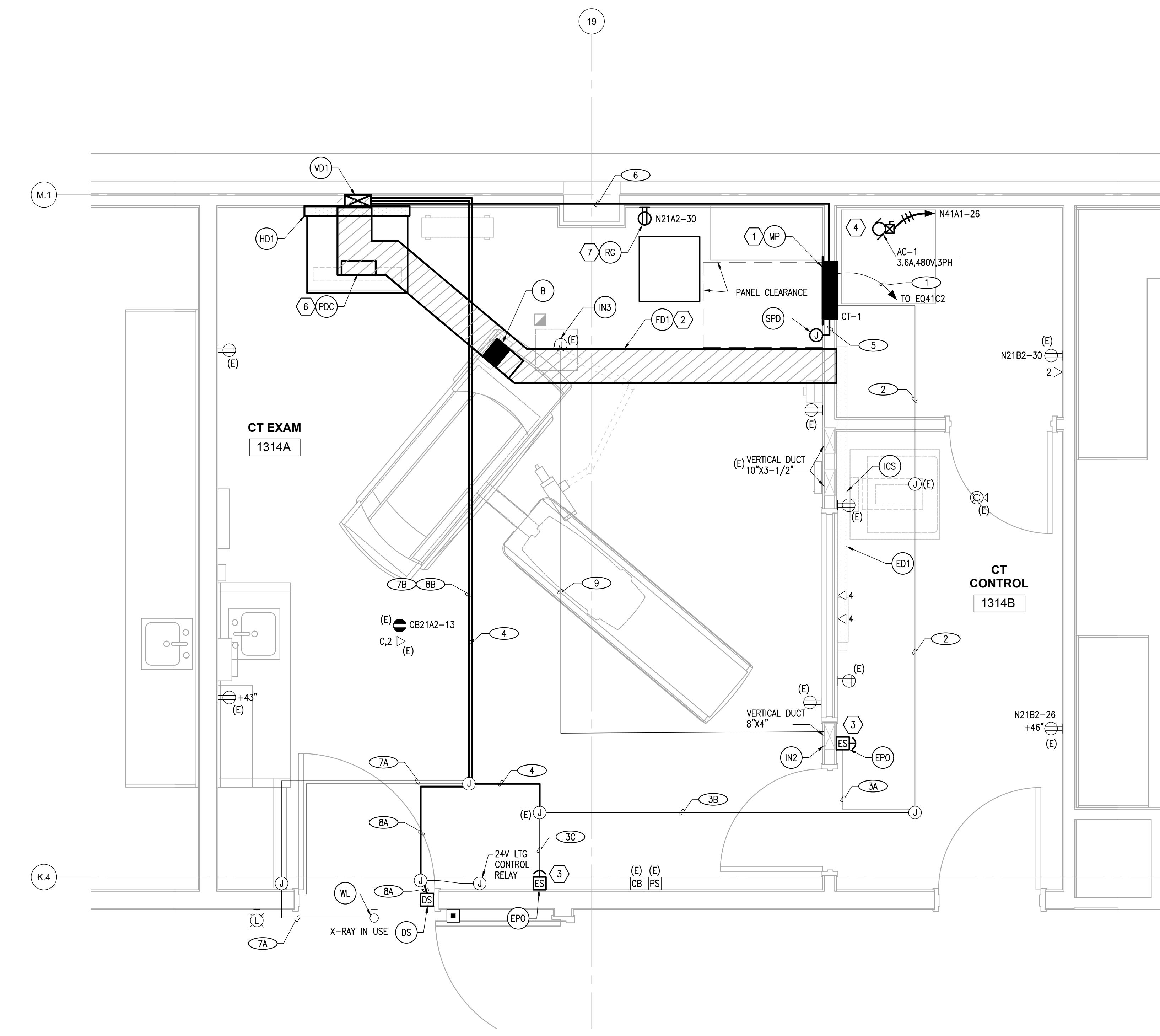
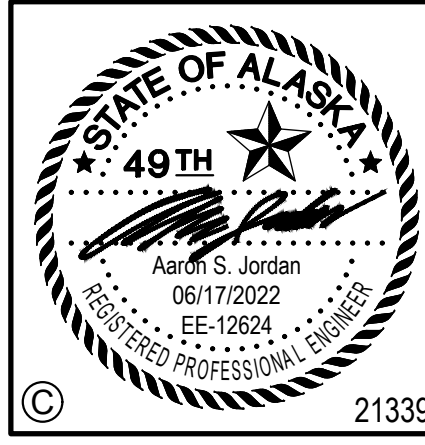

1 ENLARGED PLAN - POWER & SPECIAL SYSTEMS - CT RM 1314 - NEW
 E203 SCALE: 1/2" = 1'-0"

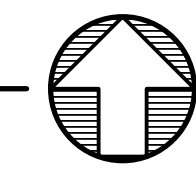

City and Borough of Juneau
**BARTLETT REGIONAL HOSPITAL MRI
& CT REPLACEMENT**
 3260 Hospital Dr. Juneau, AK 99801

Revisions		
No.	Description	Date

Drawn by ERP/MLJ/LZ	Date 06/17/2022
Checked ASJ	Job No. Project Number

Sheet Contents
 ENLARGED PLAN - POWER &
 SPECIAL SYSTEMS - CT RM 1314 -
 NEW

Sheet No.
E203

BASE BID SHEET NOTES

- REMOVE EXISTING LIGHTING FIXTURES AND CEILING DEVICES AS REQUIRED FOR ROUTING OF ABOVE CEILING CONDUITS. STORE LIGHTING FIXTURES IN A SAFE PLACE DURING CONSTRUCTION. REINSTALL CEILING DEVICES AND FIXTURES AND RECONNECT TO EXISTING CIRCUITS ON COMPLETION OF ABOVE CEILING WORK.

ALTERNATE #1 SHEET NOTES

- DEMOLISH EXISTING LIGHTING FIXTURES AND DISPOSE OF PROPERLY. RETAIN EXISTING CIRCUIT FOR CONNECTION OF NEW LIGHTING FIXTURES.
- DEMOLISH EXISTING LIGHTING CONTROL SWITCH AND ASSOCIATED LIGHTING CONTROL ACCESSORIES.
- REMOVE EXISTING CEILING MOUNTED DEVICES TO ACCOMMODATE REPLACEMENT OF CEILING GRID. REINSTALL CEILING DEVICES AND RECONNECT TO EXISTING CIRCUITS UPON COMPLETION OF CEILING INSTALLATION.
- PROVIDE NEW LIGHTING FIXTURE AT LOCATION INDICATED VIA LIGHTING CONTROL SWITCH PROVIDED IAW SHEET NOTE 5 BELOW.
- PROVIDE LIGHTING CONTROL SWITCH AT LOCATION INDICATED FOR CONTROL OF ROOM LIGHTING. REFER TO DETAILS 3 AND 4 OF THIS SHEET FOR ADDITIONAL INFORMATION.
- CT CONTROL ROOM LIGHTING CONTROL SWITCH. PROVIDE ON/OFF AND DIMMING CONTROL OF TYPE "A" FIXTURES WITH APPROVED LITHONIA SWITCH MODEL# nPODMA-DX OR EQUIVALENT.
- CT EXAM ROOM LIGHTING CONTROL SWITCH. PROVIDE ON/OFF AND DIMMING CONTROL OF TYPE "D" FIXTURES WITH APPROVED LITHONIA SWITCH MODEL# nPODMA-DX OR EQUIVALENT.
- CT EXAM ROOM LIGHTING CONTROL SWITCH. PROVIDE ON/OFF, DIMMING, AND CCT TUNNING CONTROL OF TYPE "B" FIXTURES WITH APPROVED LITHONIA SWITCH MODEL# nPODMA-2P-DX OR EQUIVALENT.
- EXISTING LIGHTING CIRCUIT SERVING THIS ROOM.
- REFER TO LIGHTING FIXTURE SCHEDULE ON SHEET E003 FOR LIGHTING FIXTURES ASSOCIATED WITH THIS SHEET.



ARCHITECTS ALASKA
AK Corp. Authorization AECC561
900 W. 5th Avenue, Suite 403
Anchorage, Alaska 99501-2029
907.272.3567 907.277.1732 fax
191 E. Swanson Avenue, Suite 203
Wasilla, Alaska 99654-7025
907.373.7503 907.376.3166 fax
347 S. Ferguson Ave, Suite 3
Bozeman, Montana 59715
406.404.1588
www.architectsalaska.com



ENGINEERS
www.amc-engineers.com
Adams, Morgenthaler & Co., Inc.
COA No. C3342 - 907.257.9100
701 E. Tudor Rd., Suite 250
Anchorage, AK 99503



21339

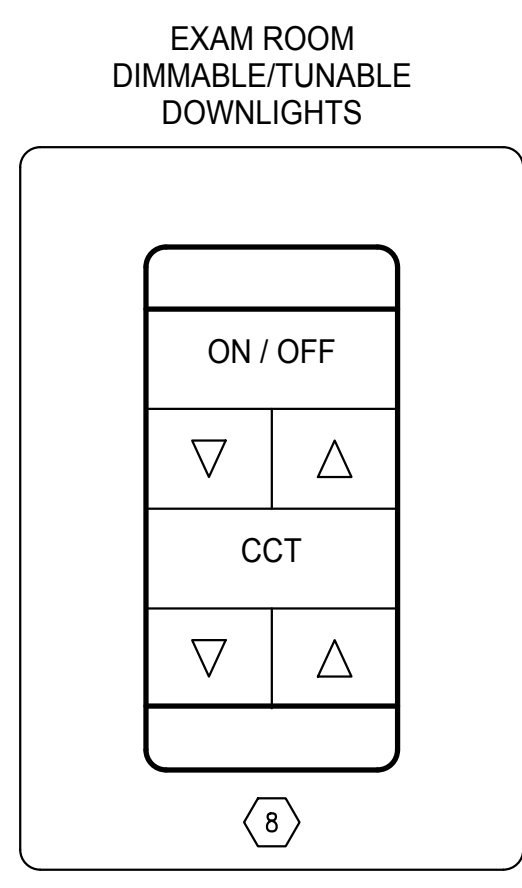
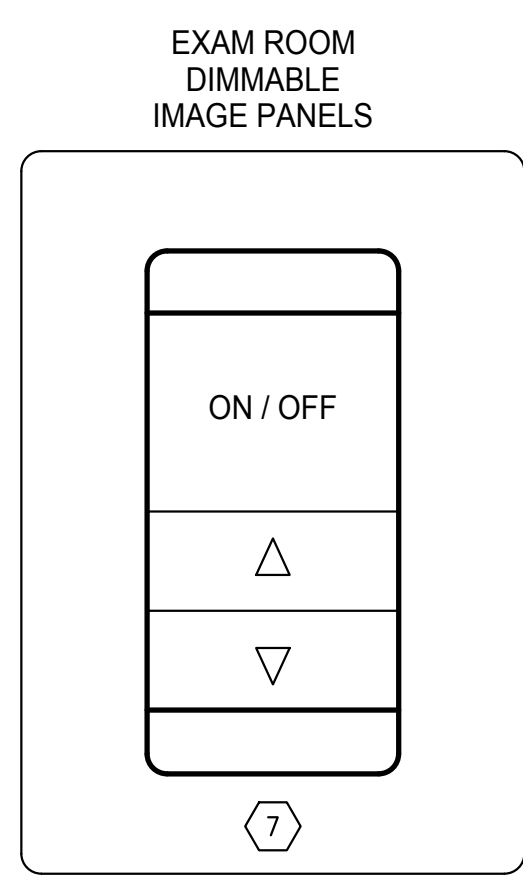
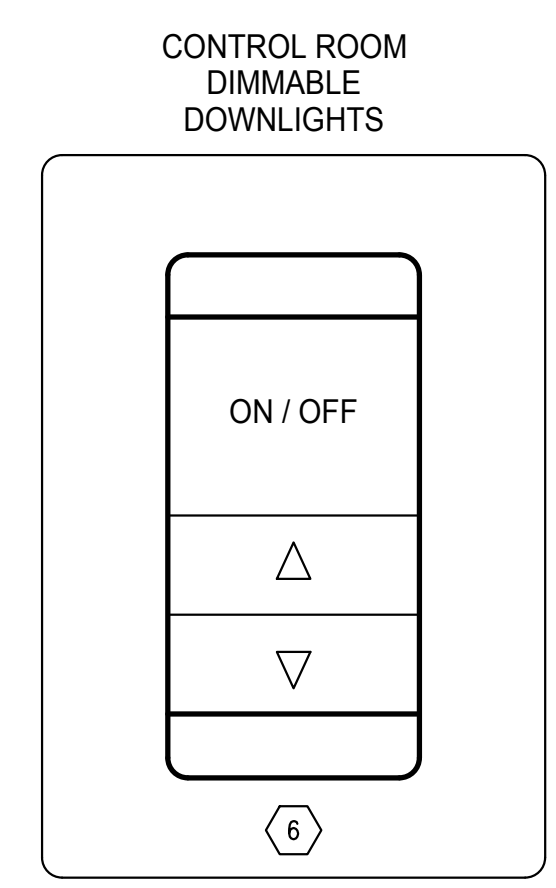

3 CONTROL ROOM - LIGHTING CONTROL
E301 SCALE: NONE

4 EXAM ROOM - LIGHTING CONTROL
E301 SCALE: NONE

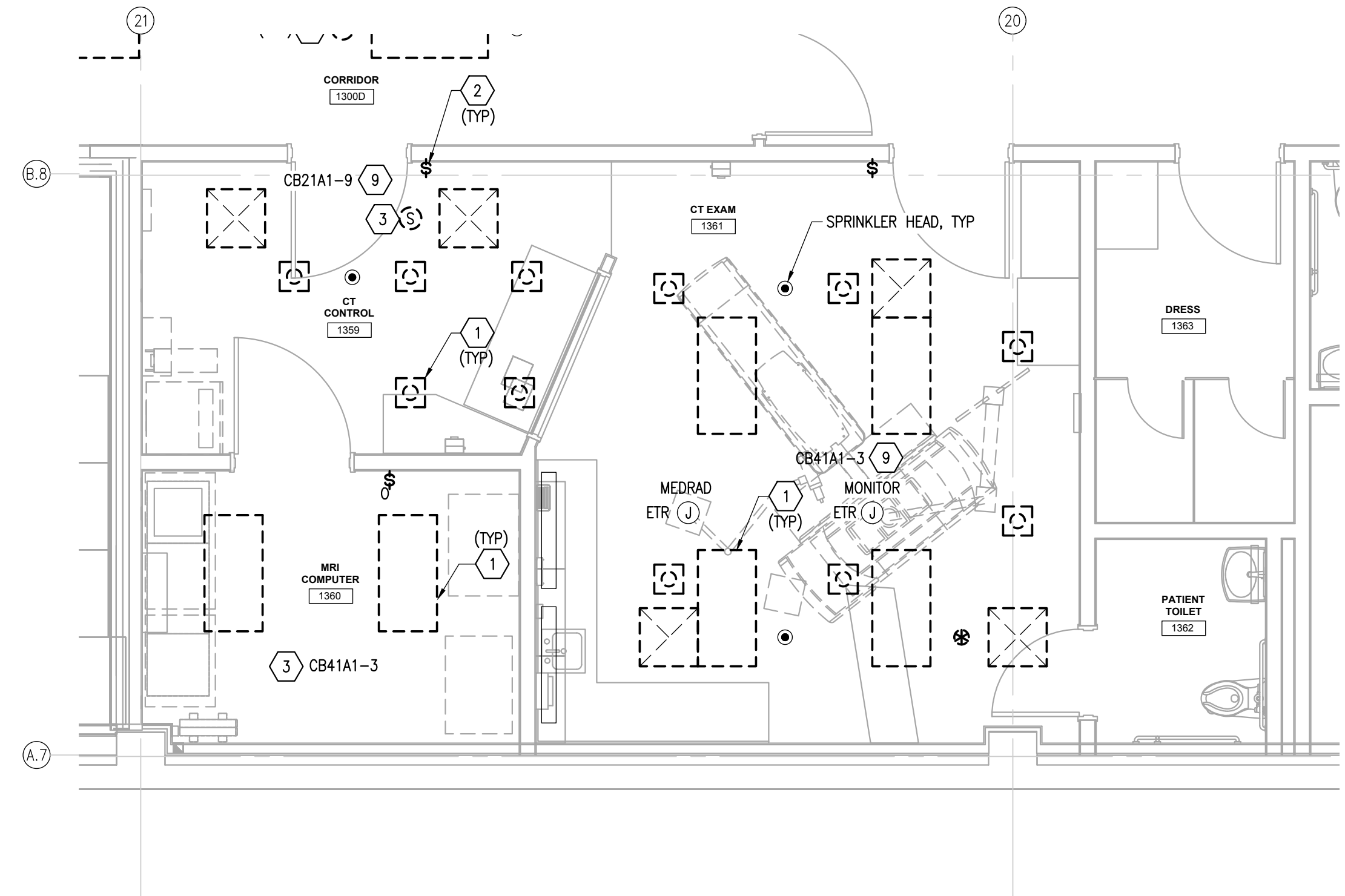

1 DEMOLITION PLAN - LIGHTING - CT RM 1361
E301 SCALE: 1/4" = 1'-0"

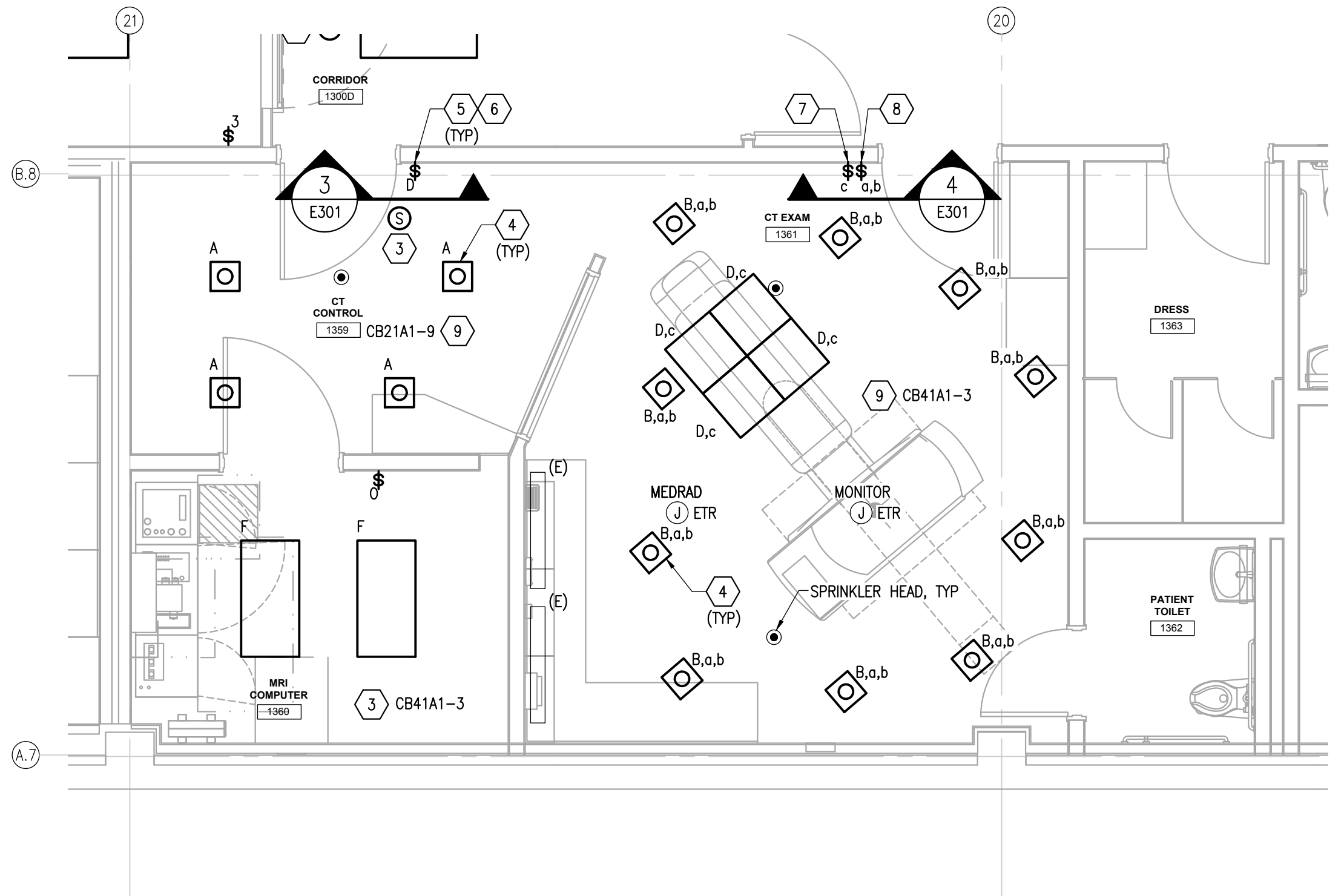
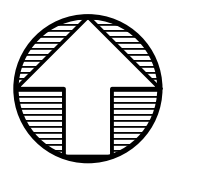

2 ENLARGED PLAN - LIGHTING - CT RM 1361 - NEW
E301 SCALE: 1/4" = 1'-0"

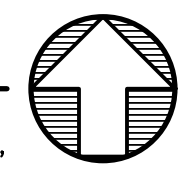

City and Borough of Juneau
BARTLETT REGIONAL HOSPITAL MRI & CT REPLACEMENT
3260 Hospital Dr. Juneau, AK 99801

Revisions		
No.	Description	Date

Drawn by ERP/MLJLZ	Date 06/17/2022
Checked ASJ	Job No. Project Number

Sheet Contents
ENLARGED PLAN - LIGHTING - CT RM 1361 - DEMO & NEW

Sheet No.
E301

FILE NAME: X:\21339\BPH\MRI\CT\Drawings\Sheet Files\E301.dwg
PLOTTER: hpplc 8/17/2022 12:14 PM

FILE NAME: X:\21339\BPH\MRI\CT\Drawings\Sheet Files\21339 - E302.dwg
 PLOTTED: jpbac 8/17/2022 12:14 PM

- ### SHEET NOTES
- 1 DEMOLISH EXISTING PANEL AND ASSOCIATED CONDUCTORS.
 - 2 SAW CUT CONCRETE SLAB TO FACILITATE INSTALLATION OF NEW UNDERSLAB CONDUITS AND GANTRY FLOOR BOX PROVIDED IAW SHEET E303.
 - 3 DEMOLISH EXISTING EMERGENCY STOP BUTTONS AND ASSOCIATED CONDUCTORS. RETAIN EXISTING BACK BOXES AND CONDUIT FOR REUSE IAW SHEET E303.
 - 4 DEMOLISH EXISTING FLOOR TRENCH. PROVIDE AND COMPACT BASE MATERIAL. PROVIDE CONCRETE FLOOR SLAB AND FINISH TO MATCH EXISTING.

Architects Alaska
ARCHITECTS ALASKA
 AK Corp. Authorization AECC561
 900 W. 5th Avenue, Suite 403
 Anchorage, Alaska 99501-2029
 907.272.3567 907.277.1732 fax
 191 E. Swanson Avenue, Suite 203
 Wasilla, Alaska 99654-7025
 907.373.7503 907.376.3166 fax
 347 S. Ferguson Ave. Suite 3
 Bozeman, Montana 59715
 406.404.1588
 www.architectsalaska.com

AMC ENGINEERS
 www.amc-engineers.com
 Adams, Morgenthaler & Co., Inc.
 CoA No. C3342 - 907.257.9100
 701 E. Tudor Rd. Suite 250
 Anchorage, AK 99503

STATE OF ALASKA
 49TH
 Aaron S. Jordan
 06/17/2022
 EE-12624
 REGISTERED PROFESSIONAL ENGINEER
 © 21339

City and Borough of Juneau
**BARTLETT REGIONAL HOSPITAL MRI
 & CT REPLACEMENT**
 3260 Hospital Dr. Juneau, AK 99801

Revisions		
No.	Description	Date

Drawn by ERP/MLJ/LZ	Date 06/17/2022
Checked ASJ	Job No. Project Number

Sheet Contents
 ENLARGED PLAN - POWER &
 SPECIAL SYSTEMS - CT RM 1361 -
 DEMO

Sheet No.
E302

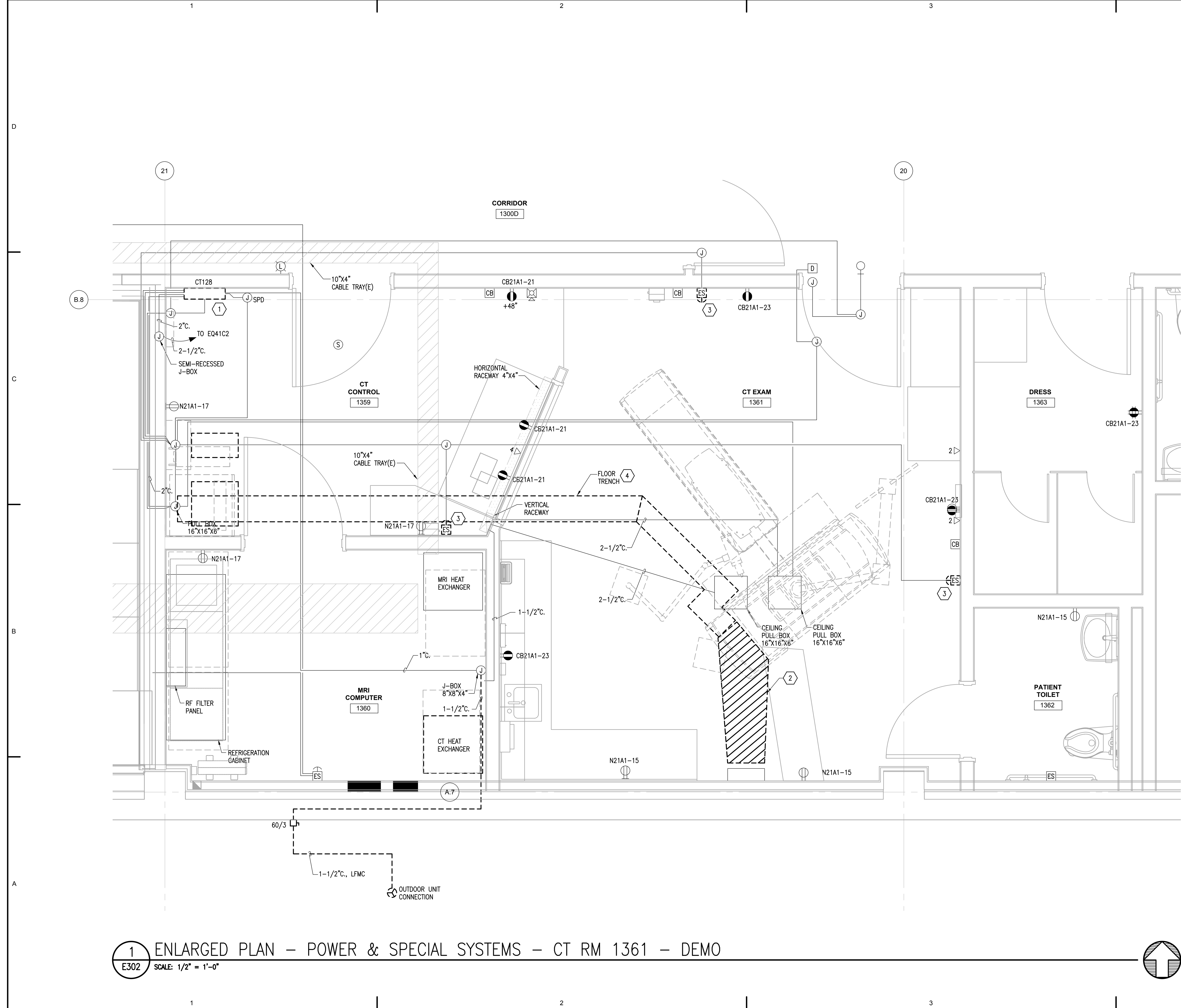

1 ENLARGED PLAN - POWER & SPECIAL SYSTEMS - CT RM 1361 - DEMO
 E302 SCALE: 1/2" = 1'-0"

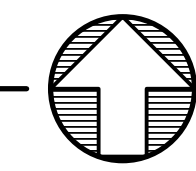

FILE NAME: X:\21339\BHM\MRI\CT\Drawings\Sheet Files\21339 - E303.dwg
 PLOTTED: jpbac 8/17/2022 12:14 PM

- ### SHEET NOTES
- 1 PROVIDE MAIN CT PANEL AT LOCATION INDICATED IAW WITH POWER ONE-LINE DIAGRAM ON SHEET E701. ROUTE NEW FEEDER ABOVE CEILINGS IN CORRIDORS.
 - 2 PROVIDE UNDERSLAB CONDUITS AT APPROXIMATE LOCATION INDICATED. ROUTE CONDUIT FROM CT MACHINE UNDERSLAB TO VERTICAL WALL CHASE. BACKFILL TRENCH AND PATCH CONCRETE SLAB TO MATCH EXISTING.
 - 3 PROVIDE EMERGENCY SHUTDOWN BUTTONS AND ASSOCIATED CABLING AND CONNECTIONS IAW POWER ONE-LINE DIAGRAM ON SHEET E701.
 - 4 MECHANICAL AND ELECTRICAL CONDUIT CHASE. ROUTE CONDUITS FROM UNDERSLAB TO ACCESSIBLE CEILING SPACE IN CHASE. REFER TO ARCHITECTURAL PLANS FOR ADDITIONAL INFORMATION.
 - 5 REUSE EXISTING CABLE PATHWAYS TO THE GREATEST EXTENT PRACTICAL.
 - 6 REFER TO SIEMENS FURNISHED LITERATURE FOR ADDITIONAL INSTALLATION REQUIREMENTS. FULLY COORDINATE WORK WITH BOTH THESE CONTRACT DOCUMENTS AND SIEMENS LITERATURE, NOTIFY OWNER OF ANY DISCREPANCIES IMPACTING INSTALLATION AS INDICATED.

**Architects
Alaska.**

ARCHITECTS ALASKA
 AK Corp. Authorization AECC561
 900 W. 5th Avenue, Suite 403
 Anchorage, Alaska 99501-2029
 907.272.3567 907.277.1732 fax
 191 E. Swanson Avenue, Suite 203
 Wasilla, Alaska 99654-7025
 907.373.7503 907.376.3166 fax
 347 S. Ferguson Ave. Suite 3
 Bozeman, Montana 59715
 406.404.1588
 www.architectsalaska.com

**AMC
ENGINEERS**

www.amc-engineers.com
 Adams, Morgenthaler & Co., Inc.
 CoA No. C3342 - 907.257.9100
 701 E. Tudor Rd. Suite 250
 Anchorage, AK 99503

STATE OF ALASKA
 49TH
 Aaron S. Jordan
 06/17/2022
 EE-12624
 REGISTERED PROFESSIONAL ENGINEER
 21339

City and Borough of Juneau
**BARTLETT REGIONAL HOSPITAL MRI
& CT REPLACEMENT**
 3260 Hospital Dr. Juneau, AK 99801

Revisions		
No.	Description	Date

Drawn by ERP/MLJLZ	Date 06/17/2022
Checked ASJ	Job No. Project Number

Sheet Contents
 ENLARGED PLAN - POWER &
 SPECIAL SYSTEMS - CT RM 1361 -
 NEW

Sheet No.
E303

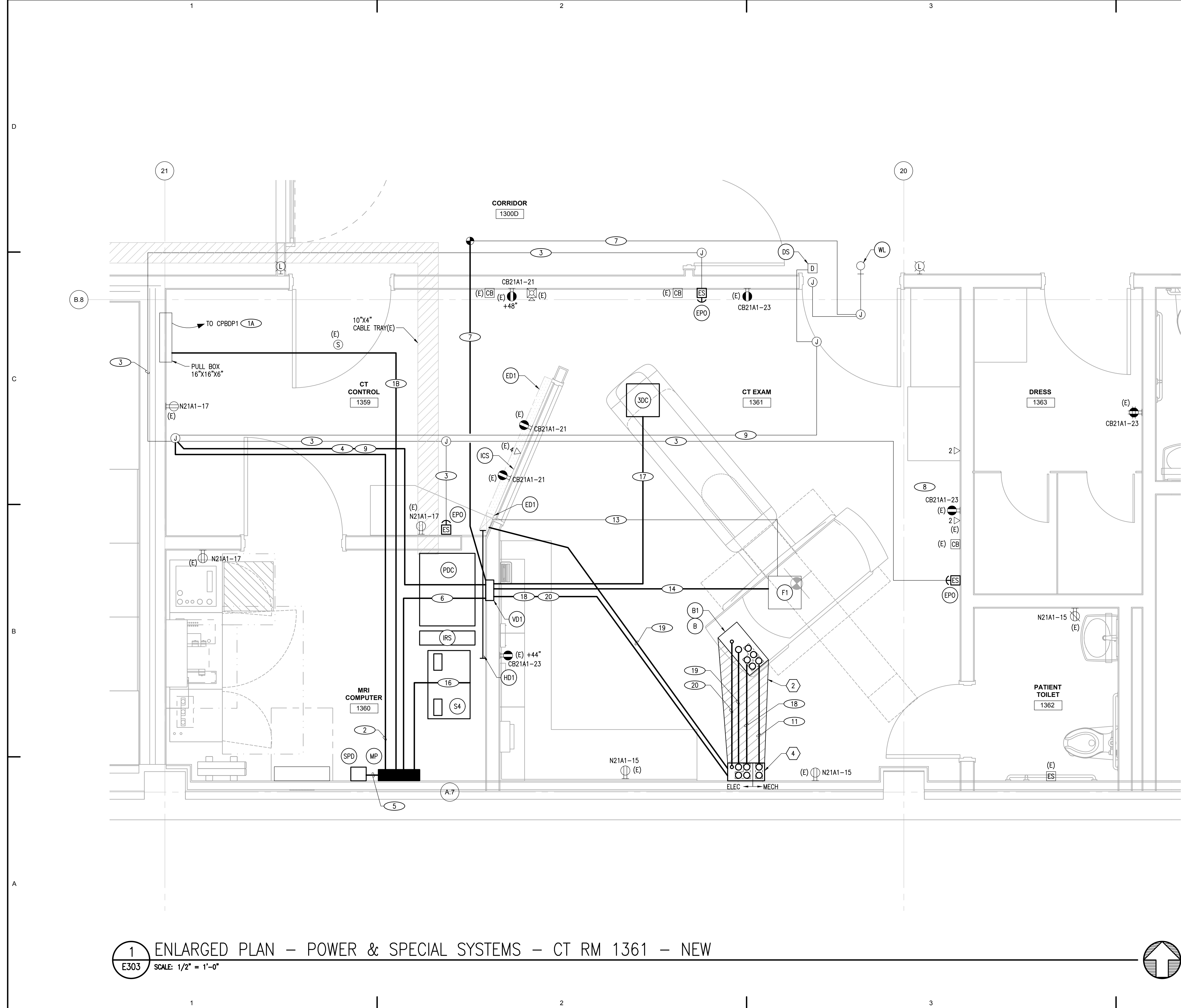

1 ENLARGED PLAN - POWER & SPECIAL SYSTEMS - CT RM 1361 - NEW
 E303 SCALE: 1/2" = 1'-0"

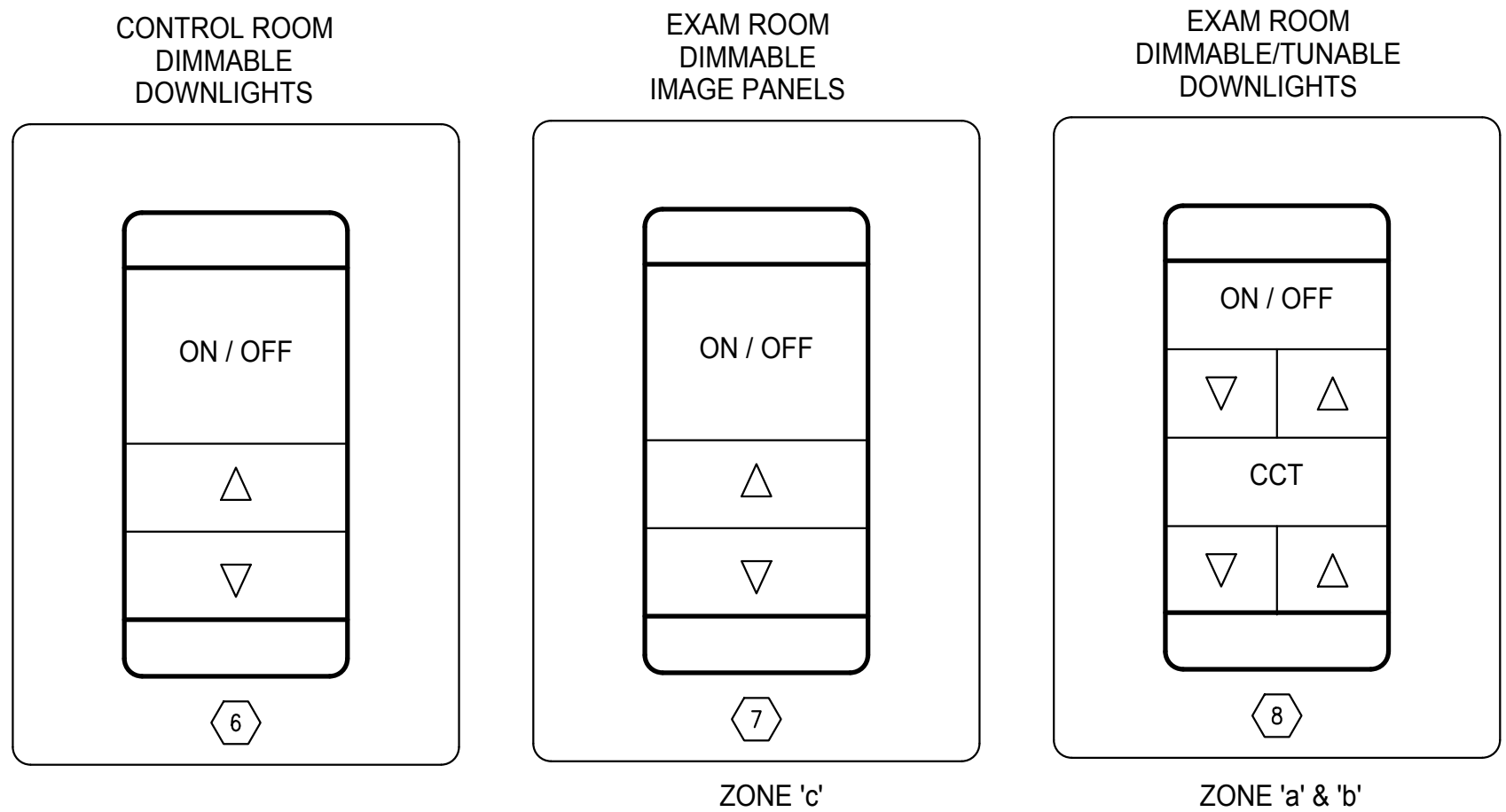

BASE BID SHEET NOTES

- REMOVE EXISTING LIGHTING FIXTURES AND CEILING DEVICES AS REQUIRED FOR ROUTING OF ABOVE CEILING CONDUITS. STORE LIGHTING FIXTURES IN A SAFE PLACE DURING CONSTRUCTION. REINSTALL CEILING DEVICES AND FIXTURES AND RECONNECT TO EXISTING CIRCUITS ON COMPLETION OF ABOVE CEILING WORK.
- REMOVE EXISTING CEILING MOUNTED DEVICES IN HALLWAY TO ACCOMMODATE REPLACEMENT OF CEILING GRID. REINSTALL CEILING DEVICES AND RECONNECT TO EXISTING CIRCUITS ON COMPLETION OF CEILING INSTALLATION. REFER TO ARCHITECTURAL DRAWINGS FOR FULL EXTENT OF CEILING REPLACEMENT.

ALTERNATE #1 SHEET NOTES

- DEMOLISH EXISTING LIGHTING FIXTURES AND DISPOSE OF PROPERLY. RETAIN EXISTING CIRCUIT FOR CONNECTION TO NEW LIGHTING FIXTURES.
- DEMOLISH EXISTING LIGHTING CONTROL SWITCH AND ASSOCIATED LIGHTING CONTROL ACCESSORIES.
- EXISTING LIGHTING CIRCUIT SERVING THIS ROOM.
- PROVIDE NEW LIGHTING FIXTURE AT LOCATION INDICATED VIA LIGHTING CONTROL SWITCH PROVIDED IN AS SHEET NOTE 5 BELOW.
- PROVIDE LIGHTING CONTROL SWITCH AT LOCATION INDICATED FOR CONTROL OF ROOM LIGHTING. REFER TO DETAILS 3 OF THIS SHEET FOR ADDITIONAL INFORMATION.
- MRI CONTROL ROOM LIGHTING CONTROL SWITCH. PROVIDE ON/OFF AND DIMMING CONTROL OF TYPE "A" FIXTURES WITH APPROVED LITHONIA SWITCH MODEL# nPODMA-DX OR EQUIVALENT.
- MRI EXAM ROOM LIGHTING CONTROL SWITCH. PROVIDE ON/OFF AND DIMMING CONTROL OF TYPE "C" FIXTURES WITH APPROVED LITHONIA SWITCH MODEL# nPODMA-DX OR EQUIVALENT.
- MRI EXAM ROOM LIGHTING CONTROL SWITCH. PROVIDE ON/OFF, DIMMING, AND CCT TUNNING CONTROL OF TYPE "C" FIXTURES WITH APPROVED LITHONIA SWITCH MODEL# nPODMA-2P-DX OR EQUIVALENT.
- PROVIDE LIGHTING FIXTURE AT LOCATION INDICATED AND CONNECT TO CONTROL ROOM CIRCUIT. FIXTURE TO BE CONTROLLED WITH CONTROL ROOM LIGHTING.
- REFER TO LIGHTING FIXTURE SCHEDULE ON SHEET E004 FOR LIGHTING FIXTURES ASSOCIATED WITH THIS SHEET.

3 CONTROL ROOM - LIGHTING CONTROL
E401 SCALE: NONE

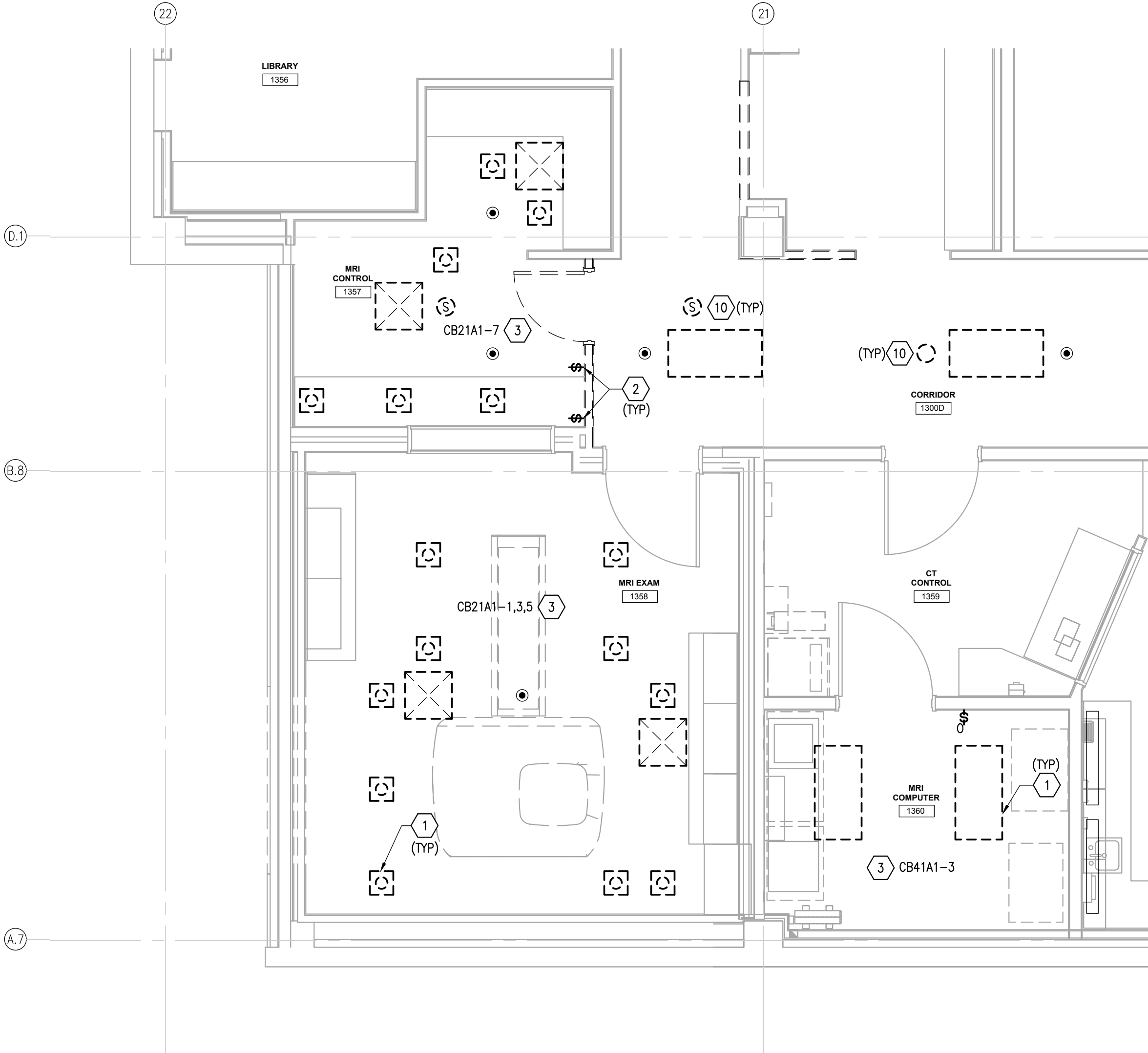

1 DEMOLITION PLAN - LIGHTING - MRI 1358
E401 SCALE: 1/4" = 1'-0"

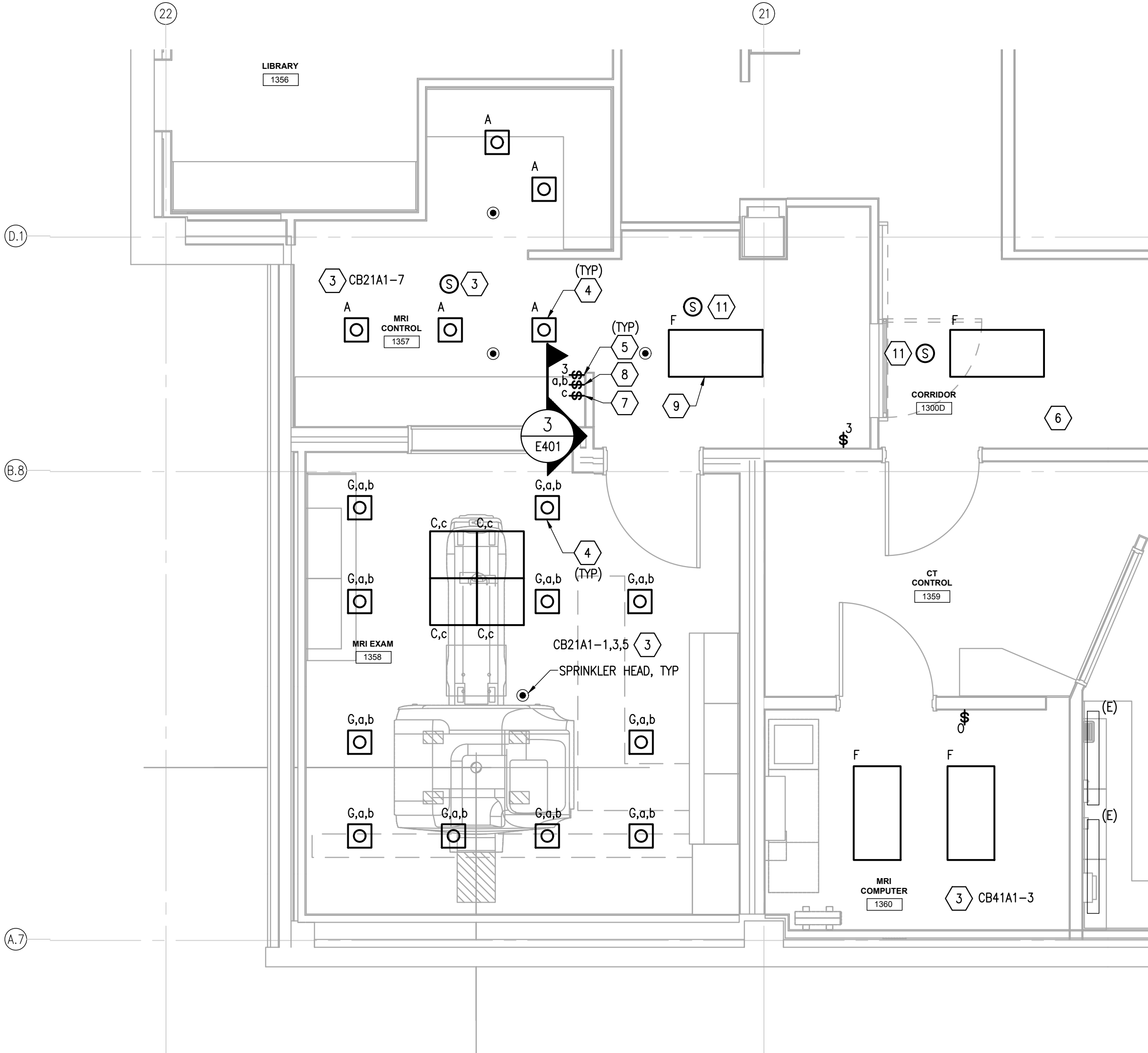

2 ENLARGED PLAN - LIGHTING - MRI 1358 - NEW
E401 SCALE: 1/4" = 1'-0"



Architects Alaska
ARCHITECTS ALASKA
AK Corp. Authorization AECC561
900 W. 5th Avenue, Suite 403
Anchorage, Alaska 99501-2029
907.272.3567 907.277.1732 fax
191 E. Swanson Avenue, Suite 203
Wasilla, Alaska 99654-7025
907.373.7503 907.376.3166 fax
347 S. Ferguson Ave. Suite 3
Bozeman, Montana 59715
406.404.1588
www.architectsalaska.com

AMC ENGINEERS
www.amc-engineers.com
Adams, Morgenthaler & Co., Inc.
COA No. C3342 - 907.257.9100
701 E. Tudor Rd. Suite 250
Anchorage, AK 99503



City and Borough of Juneau
BARTLETT REGIONAL HOSPITAL MRI & CT REPLACEMENT
3260 Hospital Dr. Juneau, AK 99801

Revisions

No.	Description	Date

Drawn by ERP/MLP/JLZ	Date 06/17/2022
Checked ASJ	Job No. Project Number

Sheet Contents
ENLARGED PLAN - LIGHTING - MRI
1358 - DEMO & NEW

Sheet No.
E401

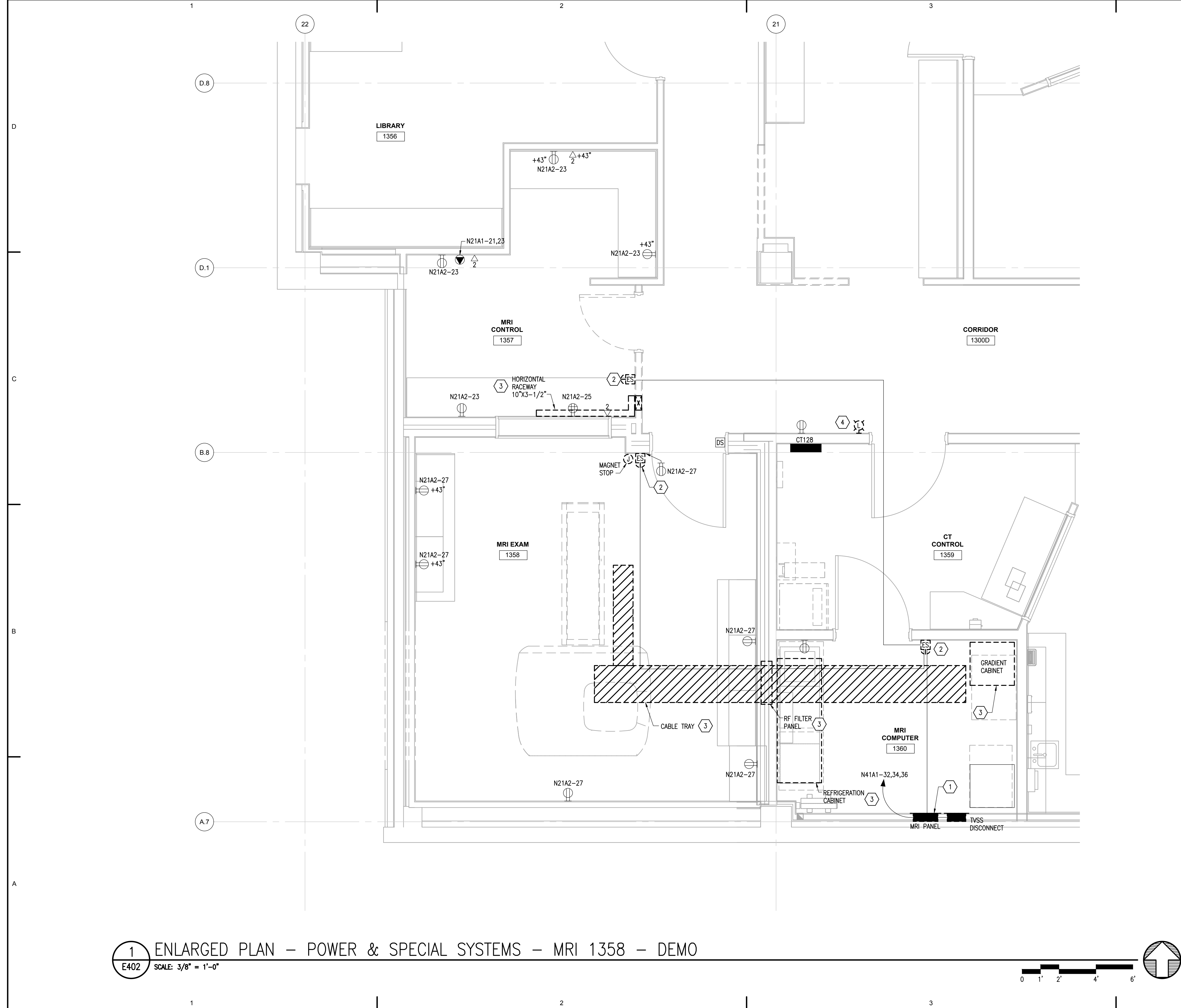

- ### SHEET NOTES
- 1 DEMOLISH EXISTING PANEL AND ASSOCIATED CONDUCTORS. RETAIN EXISTING CONDUIT FOR REUSE IAW SHEET E403.
 - 2 DEMOLISH EXISTING EMERGENCY STOP BUTTONS AND ASSOCIATED CONDUCTORS. RETAIN EXISTING BACK BOXES AND CONDUIT FOR REUSE IAW SHEET E403.
 - 3 REMOVE EQUIPMENT AND ASSOCIATED CABLING. COORDINATE RETURN/DISPOSAL REQUIREMENTS WITH BRH AND EQUIPMENT MANUFACTURER.
 - 4 REMOVE AND RELOCATE EXISTING NURSE CALL DOME LIGHT IAW SHEET E403.

Architects Alaska
ARCHITECTS ALASKA
 AK Corp. Authorization AECC561
 900 W. 5th Avenue, Suite 403
 Anchorage, Alaska 99501-2029
 907.272.3567 907.277.1732 fax
 191 E. Swanson Avenue, Suite 203
 Wasilla, Alaska 99654-7025
 907.373.7503 907.376.3166 fax
 347 S. Ferguson Ave. Suite 3
 Bozeman, Montana 59715
 406.404.1588
 www.architectsalaska.com

AMC ENGINEERS
 www.amc-engineers.com
 Adams, Morgenthaler & Co., Inc.
 CoA No. C3342 - 907.257.9100
 701 E. Tudor Rd. Suite 250
 Anchorage, AK 99503



City and Borough of Juneau
**BARTLETT REGIONAL HOSPITAL MRI
 & CT REPLACEMENT**
 3260 Hospital Dr. Juneau, AK 99801

Revisions		
No.	Description	Date

Drawn by ERP/MLJ/LJZ	Date 06/17/2022
Checked ASJ	Job No. Project Number

Sheet Contents
 ENLARGED PLAN - POWER &
 SPECIAL SYSTEMS - MRI 1358 -
 DEMO

Sheet No.
E402

1 ENLARGED PLAN - POWER & SPECIAL SYSTEMS - MRI 1358 - DEMO
 E402 SCALE: 3/8" = 1'-0"

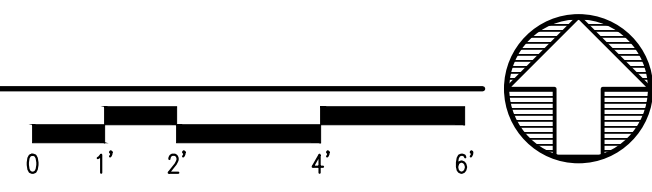

FILE NAME: X:\21339\BRH\MRI\CT\Drawings\Sheet Files\21339 - E402.dwg
 PLOTTED: jpbac 8/17/2022 12:14 PM

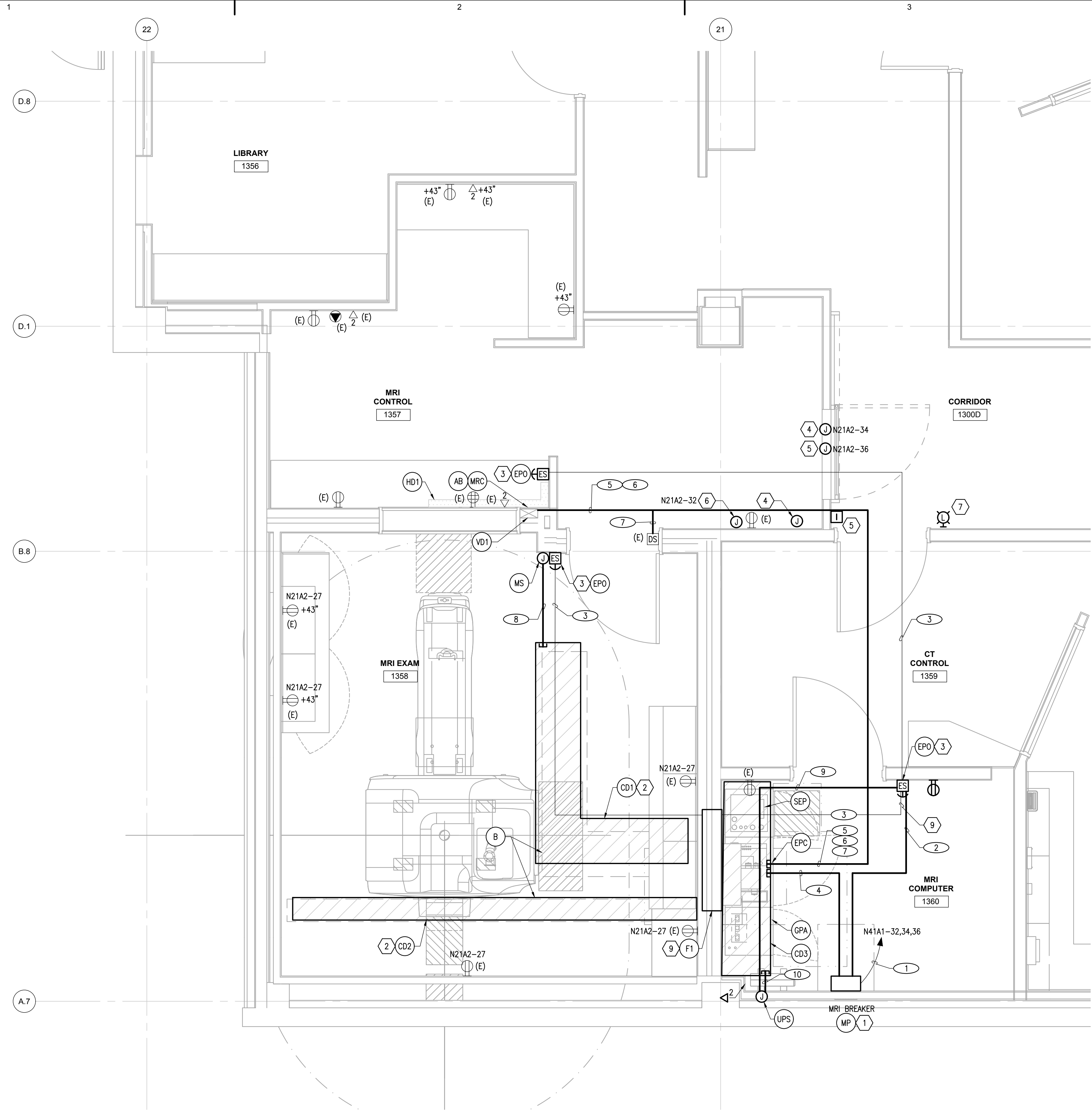

- ### SHEET NOTES
- 1 PROVIDE MAIN MRI CIRCUIT BREAKER AT LOCATION INDICATED IAW WITH POWER ONE-LINE DIAGRAM ON SHEET E701. ROUTE NEW FEEDER ABOVE CEILINGS IN CORRIDORS.
 - 2 PROVIDE CABLE TRAY ABOVE ACCESSIBLE CEILING SPACE AT LOCATIONS INDICATED.
 - 3 PROVIDE EMERGENCY SHUTDOWN BUTTONS AND ASSOCIATED CABLING AND CONNECTIONS IAW POWER ONE-LINE DIAGRAM ON SHEET E701.
 - 4 PROVIDE POWER CONNECTION TO DOOR OPERATOR AND CONTROLS IAW THE MANUFACTURERS RECOMMENDATIONS. PROVIDE JUNCTION BOX FOR AUTOMATIC DOOR OPENER CONTROL AT 42 INCHES AFF, COORDINATE LOCATION WITH ARCHITECTURAL.
 - 5 PROVIDE POWER CONNECTION ACS AND DOOR HARDWARE POWER SUPPLIES. PROVIDE CARD READER AND CONFIGURE SUCH THAT VALID CARD READ ACCUATES AUTOMATIC DOOR. INTEGRATE ACS DOOR WITH EXISTING MILLENNIUM SYSTEM. PROVIDE REQUIRED COMPONENTS AND PROGRAMMING REQUIRED FOR A COMPLETE AND FULLY FUNCTIONING SYSTEM.
 - 6 PROVIDE HARDWIRED CONNECTION TO EXISTING MRI GATE CURRENTLY CONNECTED TO EXISTING RECEPTACLE. REMOVE SURFACE WIREWAY AND CONNECT TO CIRCUIT NOTED.
 - 7 RELOCATE NURSE CALL DOME LIGHT TO APPROXIMATE LOCATION INDICATED. INTERCEPT, EXTEND AND RECONNECT TO EXISTING CIRCUIT.
 - 8 PROVIDE GROUNDING BUS BAR NEAR RF FILTER PANEL AND BOND BUS BAR TO ELECTRONICS CABINET, RF FILTER PANEL, AND MRI MAGNET. REFER TO SIEMENS FURNISHED LITERATURE FOR ADDITIONAL INFORMATION.
 - 9 PROVIDE ISOLATION TRANSFORMER FOR AC POWER ENTERING MRI EXAMINATION ROOM. BOND TRANSFORMER SECONDARY WINDING GROUND TO RF PANEL GROUNDING BUS BAR.
 - 10 REUSE EXISTING CABLE PATHWAYS TO THE GREATEST EXTENT PRACTICAL.
 - 11 COORDINATE REQUIRED RF FILTERS FOR LIGHTING AND POWER CIRCUITS ENTERING THE MRI EXAM ROOM WITH THE RF SHIELDING SUPPLIER.
 - 12 REFER TO SIEMENS FURNISHED LITERATURE FOR ADDITIONAL INSTALLATION REQUIREMENTS. FULLY COORDINATE WORK WITH BOTH THESE CONTRACT DOCUMENTS AND SIEMENS LITERATURE, NOTIFY OWNER OF ANY DISCREPANCIES IMPACTING INSTALLATION AS INDICATED.

**Architects
Alaska.**

ARCHITECTS ALASKA
AK Corp. Authorization AECC561
900 W. 5th Avenue, Suite 403
Anchorage, Alaska 99501-2029
907.272.3567 907.277.1732 fax
191 E. Swanson Avenue, Suite 203
Wasilla, Alaska 99654-7025
907.373.7503 907.376.3166 fax
347 S. Ferguson Ave. Suite 3
Bozeman, Montana 59715
406.404.1588
www.architectsalaska.com

**AMC
ENGINEERS**

www.amc-engineers.com
Adams, Morgenthaler & Co., Inc.
CoA No. C0342 - 907.257.9100
701 E. Tudor Rd. Suite 250
Anchorage, AK 99503



City and Borough of Juneau
**BARTLETT REGIONAL HOSPITAL MRI
& CT REPLACEMENT**
3260 Hospital Dr. Juneau, AK 99801

Revisions		
No.	Description	Date

Drawn by ERP/MLJ/LZ	Date 06/17/2022
Checked ASJ	Job No. Project Number

Sheet Contents
ENLARGED PLAN - POWER &
SPECIAL SYSTEMS - MRI 1358 -
NEW

Sheet No.
E403

1 ENLARGED PLAN - POWER & SPECIAL SYSTEMS - MRI 1358 - NEW
E403 SCALE: 3/8" = 1'-0"

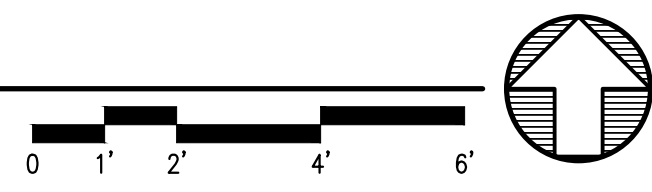

FILE NAME: X:\21339\BRH\MRI\CT\Drawings\Sheet Files\21339 - E403.dwg
PLOTTED: jpbac 6/17/2022 12:14 PM

SHEET NOTES

- INTERCEPT EXISTING CONDUIT BEFORE IT ROUTES UNDERGROUND. CONNECT NEW 2 INCH CONDUIT TO EXISTING CONDUIT AND REROUTE TO PANEL CBPD1. DEMOLISH REMAINING CONDUIT PORTION TO PANEL EQ41C2.
- REFER TO PARTIAL POWER ONE-LINE DIAGRAM FOR ADDITIONAL INFORMATION.

Architects Alaska
ARCHITECTS ALASKA
 AK Corp. Authorization AECC561
 900 W. 5th Avenue, Suite 403
 Anchorage, Alaska 99501-2029
 907.272.3567 907.277.1732 fax
 191 E. Swanson Avenue, Suite 203
 Wasilla, Alaska 99654-7025
 907.373.7503 907.376.3166 fax
 347 S. Ferguson Ave. Suite 3
 Bozeman, Montana 59715
 406.404.1588
 www.architectsalaska.com

AMC ENGINEERS
 www.amc-engineers.com
 Adams, Morgenthaler & Co., Inc.
 CoA No. C3342 - 907.257.9100
 701 E. Tudor Rd. Suite 250
 Anchorage, AK 99503

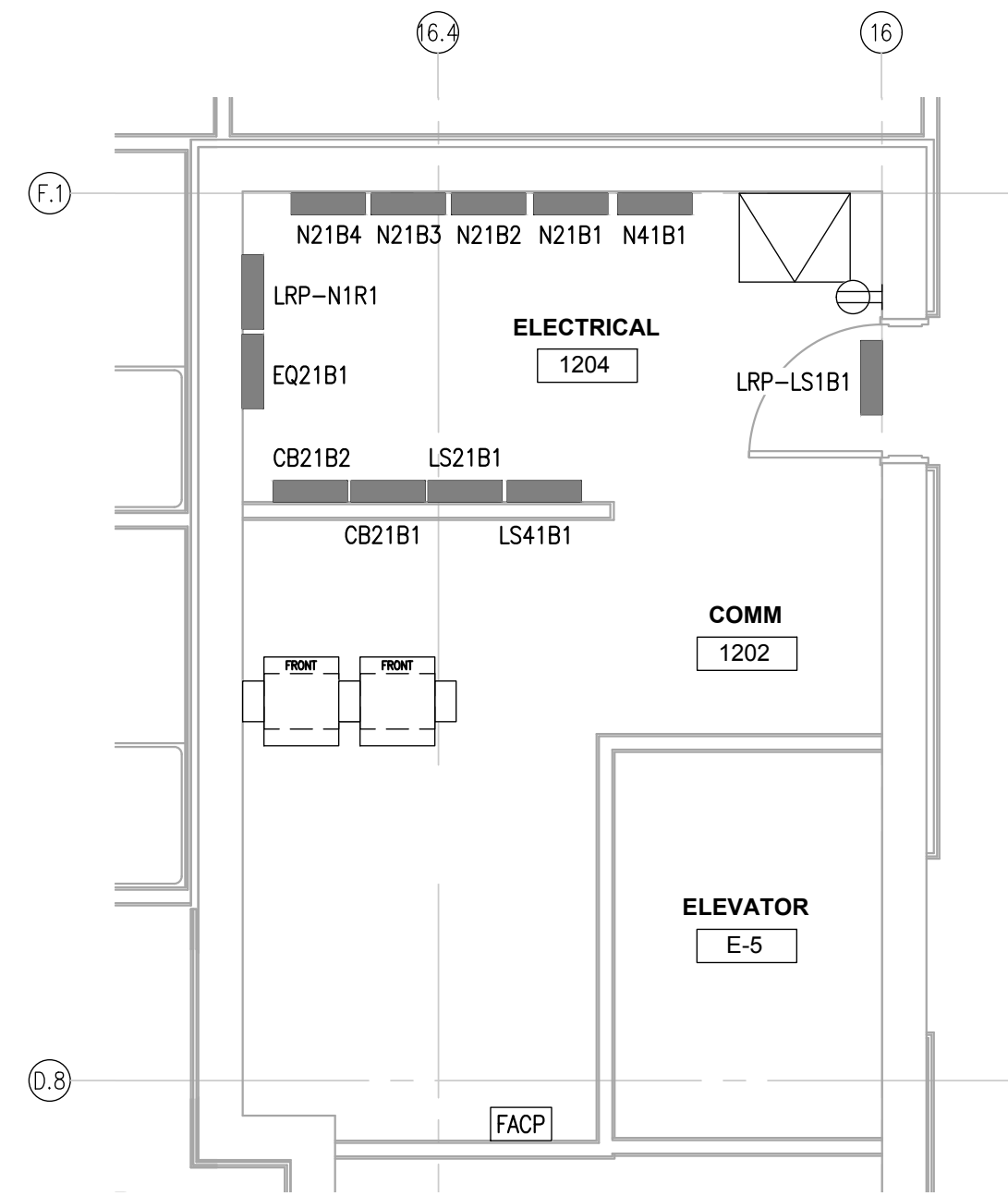

1 ENLARGED PLAN - ELECTRICAL ROOM 1204
 E501 SCALE: 1/4" = 1'-0"

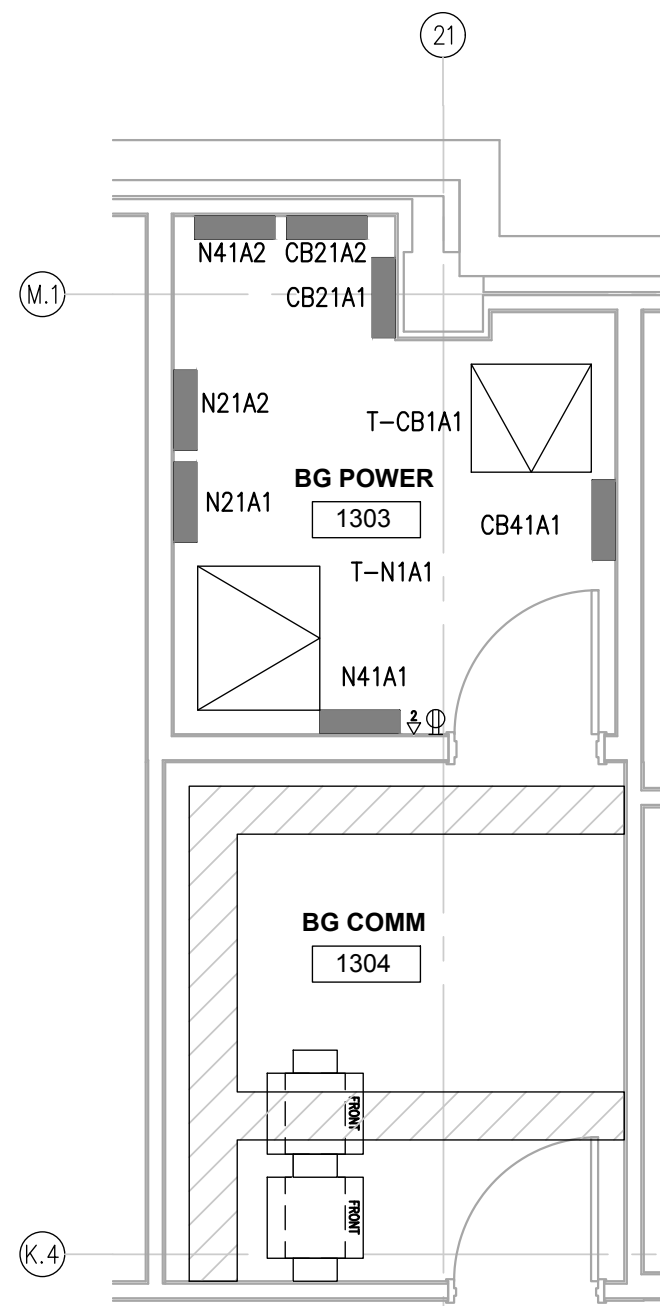

2 ENLARGED PLAN - TELECOM ROOMS
 E501 SCALE: 1/4" = 1'-0"

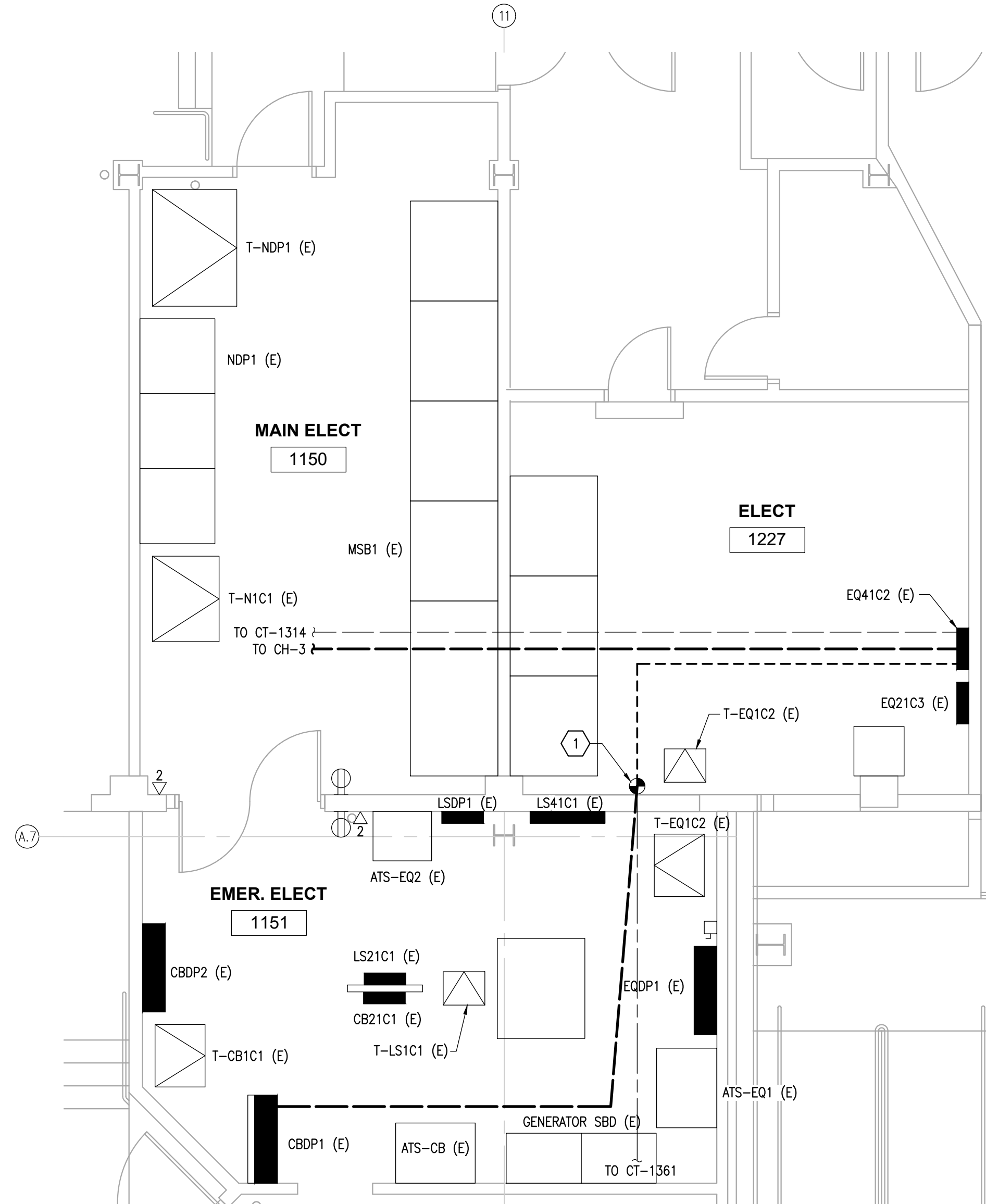

3 ENLARGED PLAN - MAIN ELECTRICAL ROOM
 E501 SCALE: 1/4" = 1'-0"

City and Borough of Juneau
BARTLETT REGIONAL HOSPITAL MRI & CT REPLACEMENT
 3260 Hospital Dr. Juneau, AK 99801

Revisions		
No.	Description	Date

Drawn by ERP/MLJ/LZ	Date 06/17/2022
Checked ASJ	Job No. Project Number

Sheet Contents
 ENLARGED PLAN - ELEC & TELECOM ROOMS

Sheet No.
E501

FILE NAME: X:\21339\BPHMRI\CT\Drawings\Sheet Files\21339 - E501.dwg
 PLOTTED: jpbac 6/17/2022 12:14 PM

FILE NAME: x:\21339\h\h\m\c\Drawings\Detail\sheet files\21339 - E601.dwg
 PLOTTED: epaguiayan 7/11/2022 12:04 PM

- DETAIL NOTES**
- 1 PROVIDE 4 INCH, GRC CONDUIT SUPPORTS FOR ELECTRICAL PANEL. EMBED CONDUIT A MINIMUM OF 48 INCHES INTO THE GROUND. SECURE METAL CHANNEL SUPPORTS TO CONDUIT WITH THREADED U-BOLTS.
 - 2 PROVIDE RIGID METAL CONDUIT (RMC) FOR TRANSITION BETWEEN LIQUID TITE FLEXIBLE METAL CONDUIT (LFMC) PROVIDED IAW SHEET NOTE 4.
 - 3 PROVIDE GALVANIZED METAL CHANNEL SUPPORTS AND MOUNT CONDUIT/EQUIPMENT TO SUPPORTS.
 - 4 UTILIZE ULTRA COLD TEMPERATURE RATED LFMC (ALTA) OR APPROVED EQUAL FOR CONNECTIONS BETWEEN PVC AND RMC. PROVIDE BEND IN LFMC TO ALLOW DIFFERENTIAL MOVEMENT BETWEEN CONDUITS AND MOBILE MRI CONNECTION.
 - 5 PROVIDE NEMA 3R, 200A, 480V, 3 PH, FUSED DISCONNECT WITH INTERLOCKED RECEPTACLE.
 - 6 PROVIDE FEMALE RECEPTACLE TO RECEIVE MOBILE MRI UNIT PLUG. MOBILE UNIT PLUG IS DS2504MP000.
 - 7 PROVIDE SIX (6) PAIR OF CAT 5E TELECOM CABLING FROM EXISTING TELECOM ROOM 1304. PROVIDE THREE (3), WEATHER PROOF, HUBBELL PH6597, MARINE TELEPHONE OUTLETS IN NEMA 3R JUNCTION BOX AND TERMINATE TELECOM CABLING ON OUTLETS. PROVIDE FOR FIFTY (50) ADDITIONAL FEET OF CABLING FOR REMAINING THREE (3) CABLES. NEATLY COIL REMAINING THREE CABLES AND SECURE INSIDE OF JUNCTION BOX. PROVIDE 1 INCH GROMMETED HOLE WITH WEATHER PROOF COVER FOR ROUTING OF COILED CABLES BY MOBILE MRI INSTALLER.

Architects Alaska
ARCHITECTS ALASKA
 AK Corp. Authorization AECC561
 900 W. 5th Avenue, Suite 403
 Anchorage, Alaska 99501-2029
 907.272.3567 907.277.1732 fax
 191 E. Swanson Avenue, Suite 203
 Wasilla, Alaska 99654-7025
 907.373.7503 907.376.3166 fax
 347 S. Ferguson Ave. Suite 3
 Bozeman, Montana 59715
 406.404.1588
 www.architectsalaska.com

AMC ENGINEERS
 www.amc-engineers.com
 Adams, Morgenthaler & Co., Inc.
 CoA No. C0342 - 907.257.9100
 701 E. Tudor Rd., Suite 250
 Anchorage, AK 99503

STATE OF ALASKA
 49TH
 Aaron S. Jordan
 07/11/2022
 EE-12624
 REGISTERED PROFESSIONAL ENGINEER
 © 21339

City and Borough of Juneau
BARTLETT REGIONAL HOSPITAL MRI & CT REPLACEMENT
 3260 Hospital Dr. Juneau, AK 99801

Revisions

No.	Description	Date

Drawn by ERP/PLJ/LZ	Date 06/17/2022
Checked ASJ	Job No. Project Number

Sheet Contents
 DETAILS - MOBILE MRI CONNECTION

Sheet No.
E601

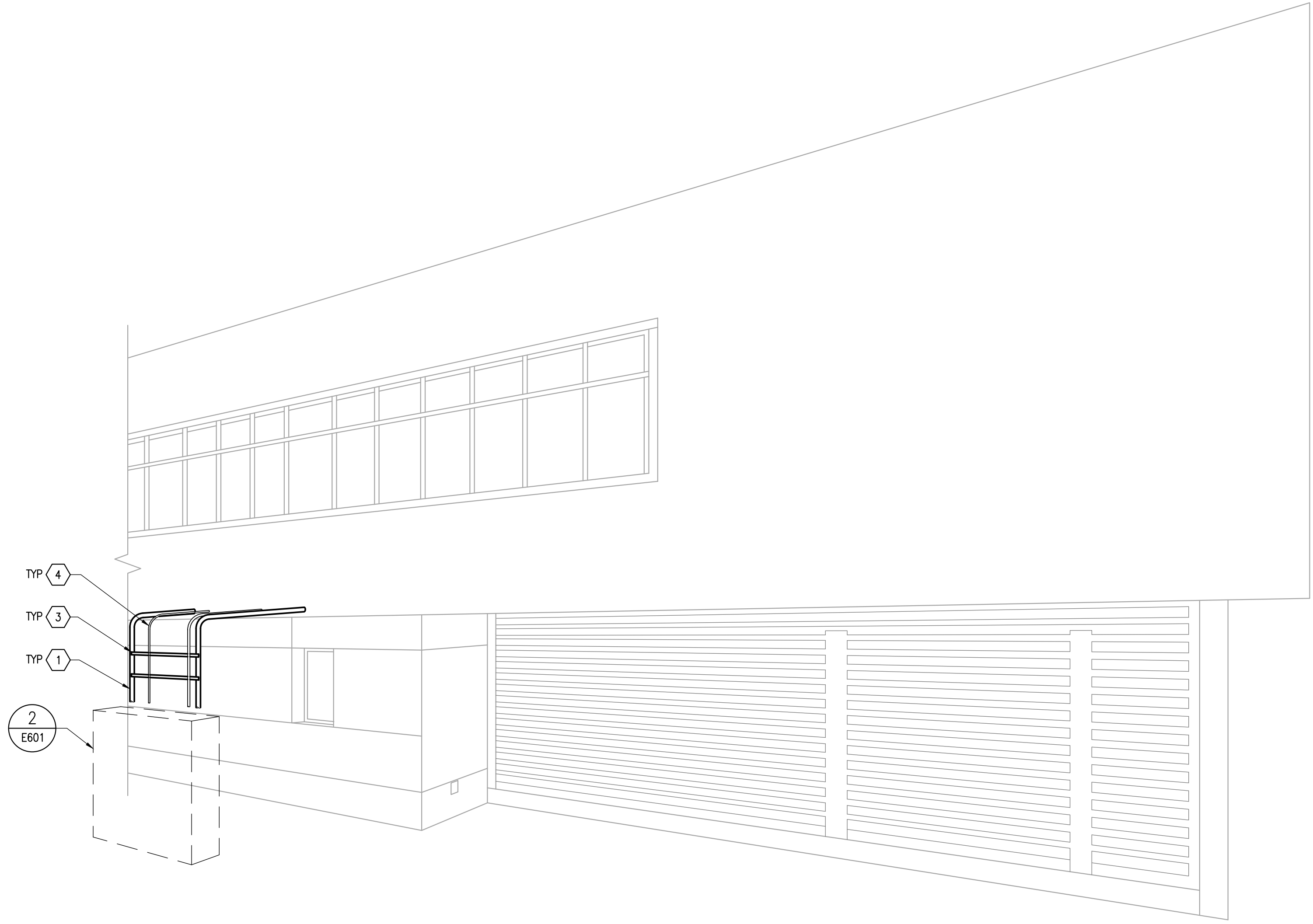

1 DETAIL - MOBILE MRI HOOK-UP
 E601 SCALE: NONE

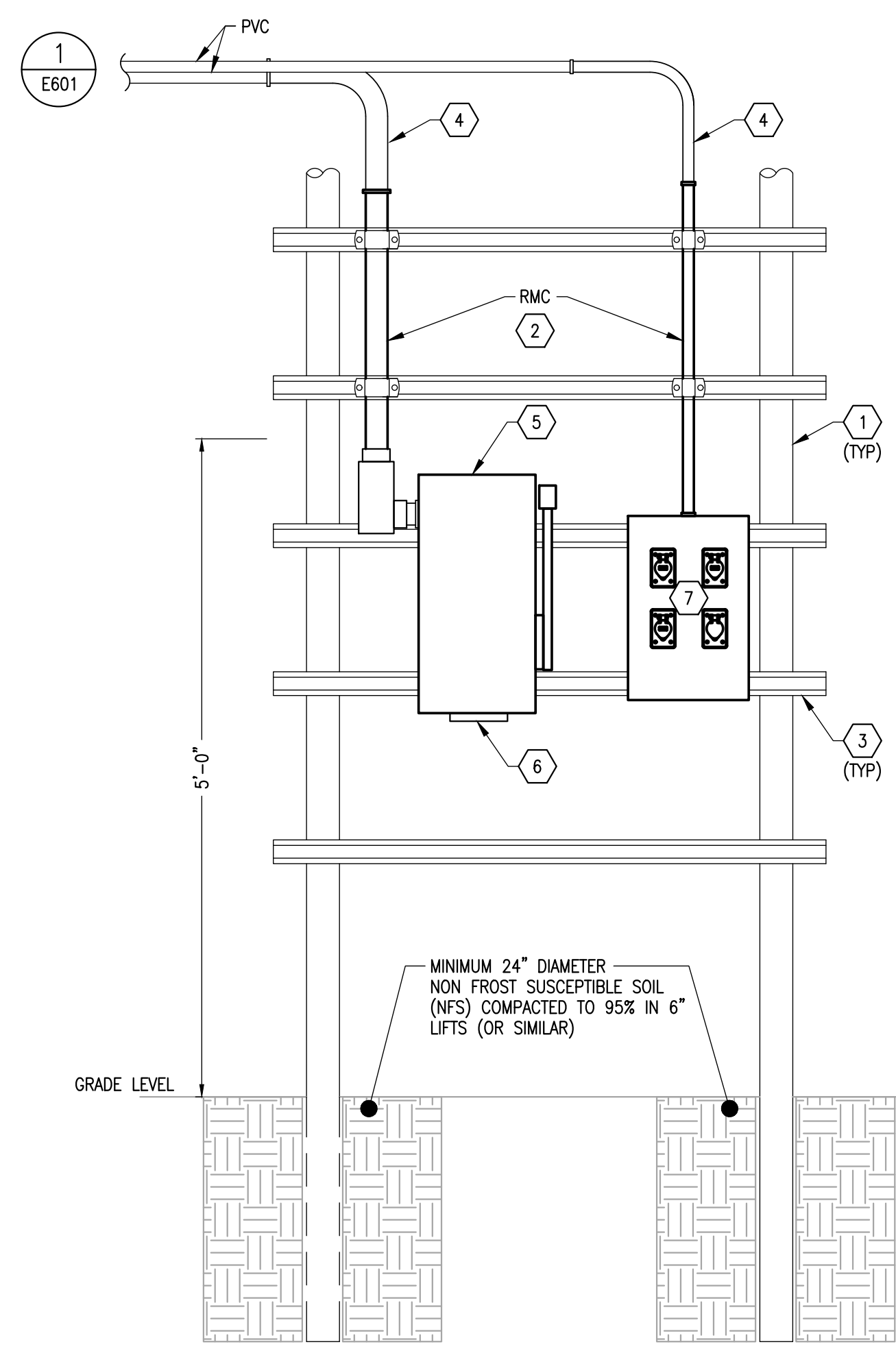

2 DETAIL - MOBILE MRI HOOK-UP
 E601 SCALE: NONE

FILE NAME: x:\21339 bh\m\ct\Draws\Electrical\sheet files\21339 - E701.dwg
 PLOTTED: epagulyan 7/11/2022 12:04 PM

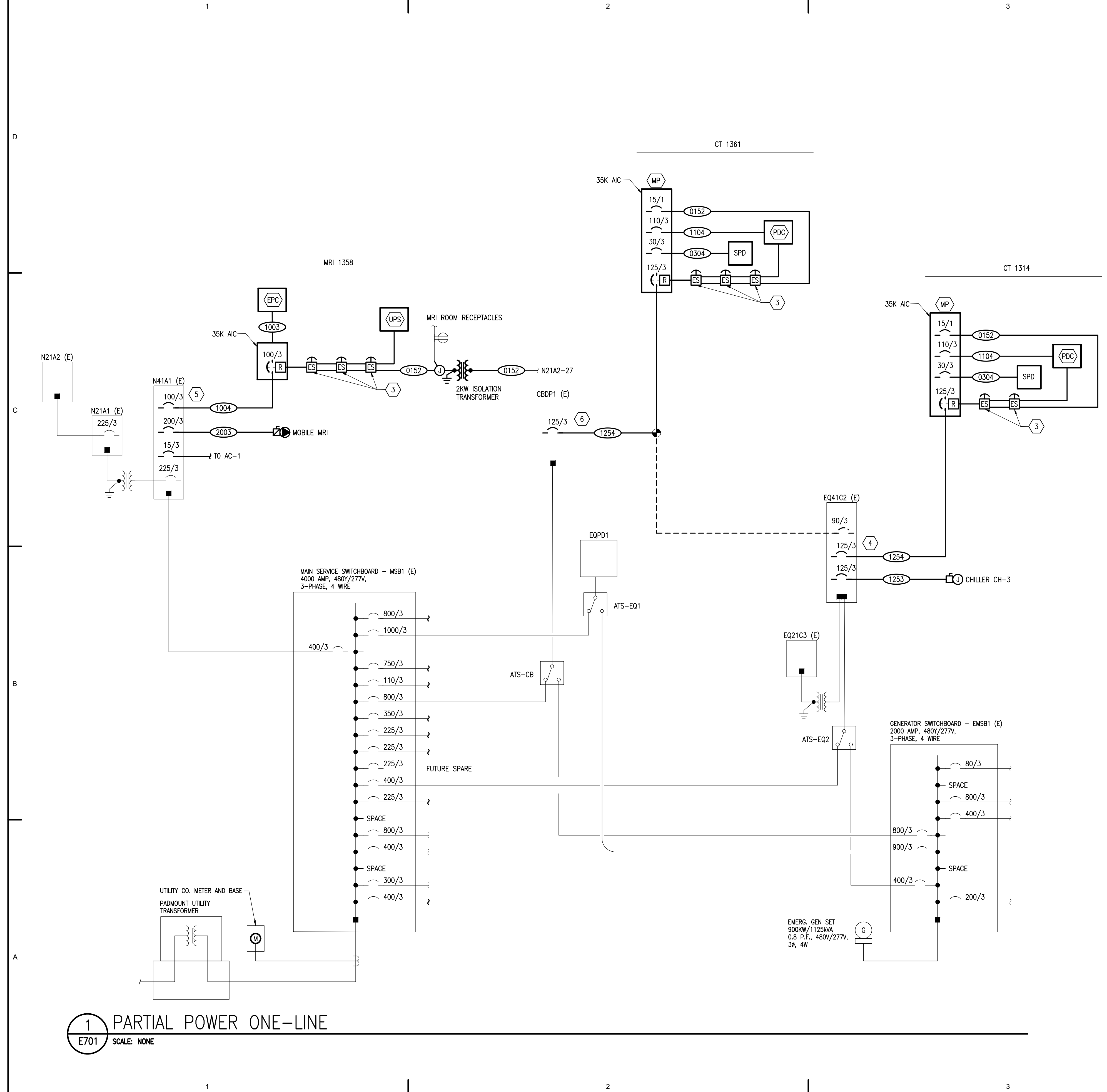

- ### DETAIL NOTES
- REFER TO PANEL SCHEDULES ON SHEETS E002, E003, & E004 FOR ADDITIONAL INFORMATION.
 - REFER TO SIEMENS SITE SPECIFIC DRAWINGS AND SPECIFICATIONS FOR ADDITIONAL INFORMATION AND COORDINATION.
 - PROVIDE 2 POSITION PUSH-PULL, LED ILLUMINATED, RED KNOB WITH "PUSH EMERGENCY STOP" PRINTED ON KNOB, MUSHROOM TYPE BUTTON, FOR REMOTE SHUTDOWN. BUTTON SHALL HAVE A MINIMUM OF ONE NORMALLY OPEN CONTACT AND ONE NORMALLY CLOSED CONTACT. CONNECT NORMALLY OPEN CONTACT TO SHUNT TRIP CIRCUIT BREAKER AND NORMALLY CLOSED TO GANTRY UPS. PROVIDE FLIP UP POLYCARBONATE COVER SUCH THAT LIFTING UP ON THE COVER WILL GAIN ACCESS TO EMERGENCY SHUT DOWN BUTTON.
 - DEMOLISH EXISTING CIRCUIT BREAKER FEEDING MAIN PANELS IN CT ROOMS. PROVIDE NEW CIRCUIT BREAKER IN EXISTING PANEL. PROVIDE NEW CONDUCTORS IN EXISTING CONDUIT.
 - DEMOLISH EXISTING CIRCUIT BREAKER FEEDING MAIN PANEL IN MRI ROOM. PROVIDE NEW CIRCUIT BREAKER IN EXISTING PANEL. PROVIDE NEW CONDUCTORS IN EXISTING CONDUIT.
 - PROVIDE NEW CIRCUIT BREAKER AND CONDUCTORS FOR CT.

FEEDER SCHEDULE

2003	2" C., 3-#3/0 AWG + 1-#6 AWG GROUND
1254	2" C., 4-#1/0 AWG + 1-#1/0 AWG GROUND
1253	2" C., 3-#1/0 AWG + 1-#6 AWG GROUND
1104	1-1/2" C., 4-#2 AWG + 1-#2 AWG GROUND
1004	1-1/4" C., 4-#1 AWG + 1-#1 AWG GROUND
1003	1-1/4" C., 3-#1 AWG + 1-#1 AWG GROUND
0304	3/4" C., 4-#10 AWG + 1-#12 AWG GROUND
0152	1/2" C., 2-#12 AWG + 1-#12 AWG GROUND

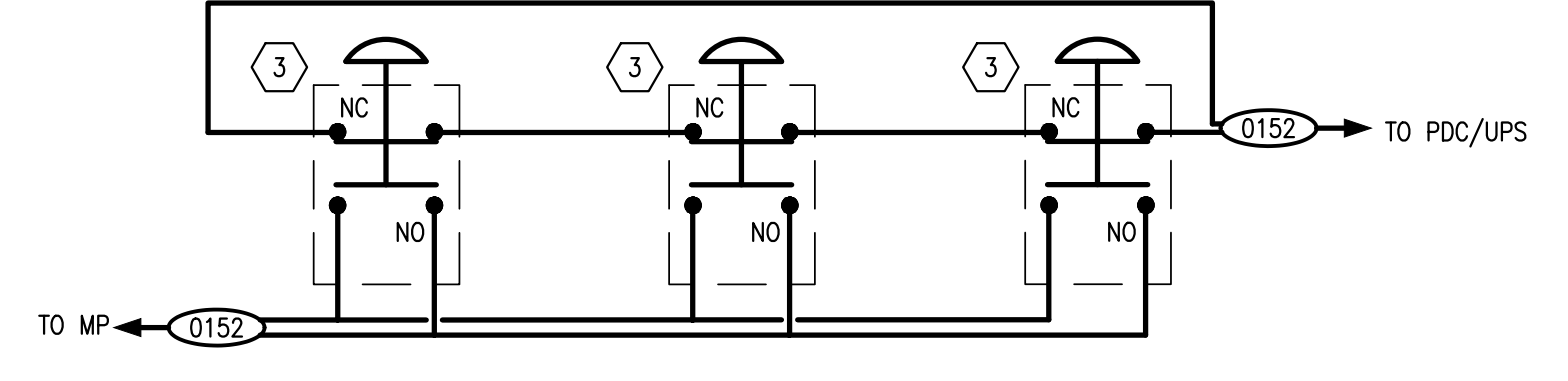

1 PARTIAL POWER ONE-LINE
 E701 SCALE: NONE

2 DIAGRAM - EMERGENCY POWER OFF BUTTONS
 E701 SCALE: NONE

Architects Alaska
 ARCHITECTS ALASKA
 AK Corp. Authorization AECC561
 900 W. 5th Avenue, Suite 403
 Anchorage, Alaska 99501-2029
 907.272.3567 907.277.1732 fax
 191 E. Swanson Avenue, Suite 203
 Wasilla, Alaska 99654-7025
 907.373.7503 907.376.3166 fax
 347 S. Ferguson Ave. Suite 3
 Bozeman, Montana 59715
 406.404.1588
 www.architectsalaska.com

AMC ENGINEERS
 www.amc-engineers.com
 Adams, Morgenthaler & Co., Inc.
 Co. No. C0342 - 907.257.9198
 701 E. Tudor Rd. Suite 250
 Anchorage, AK 99503

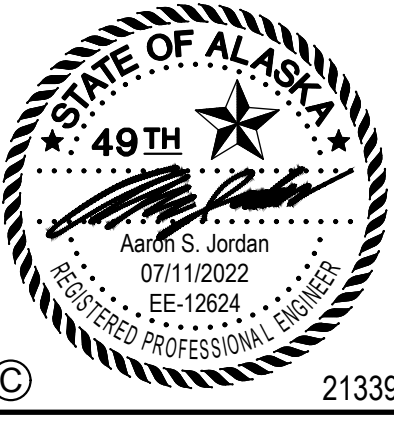

City and Borough of Juneau
BARTLETT REGIONAL HOSPITAL MRI & CT REPLACEMENT
 3260 Hospital Dr. Juneau, AK 99801

Revisions		
No.	Description	Date

Drawn by: ERP/MP/LJLZ Date: 06/17/2022
 Checked: ASJ Job No.:
 Project Number:

Sheet Contents
 PARTIAL POWER ONE-LINE

Sheet No.
E701