

UNIVERSITY DRIVE LIGHTING UPGRADES

VOLUME I of I

Contract No. BE21-092

File No. 2016



ENGINEERING DEPARTMENT

SECTION 00005 - TABLE OF CONTENTS

**DIVISION 0 - BIDDING AND CONTRACT REQUIREMENTS, CONTRACT FORMS, AND
CONDITIONS OF THE CONTRACT**

BIDDING and CONTRACT REQUIREMENTS No. of Pages

00005	Table of Contents	2
00030	Notice Inviting Bids	2
00100	Instructions to Bidders	9
00300	Bid	2
00310	Bid Schedule	1
00320	Bid Bond	1
00360	Subcontractor Report.....	3
00370	Contractor Financial Responsibility	3

CONTRACT FORMS

00500	Agreement	6
00610	Performance Bond	2
00620	Payment Bond	2

CONDITIONS OF THE CONTRACT

000700	General Conditions	47
00800	Supplementary General Conditions	6
00830	Alaska Labor Standards, Reporting, and Prevailing Wage Rate Determination.....	1
	Appendix A – Pamphlet 600- Effective September 1, 2020.....	37
00852	Permits.....	1
00853	Standard Details.....	1
	Special Provisions	40

LIST OF DRAWINGS

Sheet 1 of 7	COVER SHEET
Sheet 2 of 7	LEGEND, ABBREVIATIONS, AND GENERAL NOTES
Sheet 3 of 7	SITE PLAN
Sheet 4 of 7	ONE LINE
Sheet 5 of 7	TYPE A FIXTURE DETAIL
Sheet 6 of 7	TYPE C FIXTURE DETAIL
Sheet 7 of 7	PRECAST CONCRETE FOOTING DETAIL

END OF SECTION

SECTION 00030 NOTICE INVITING BIDS

OBTAINING CONTRACT DOCUMENTS. The Contract Documents are entitled:

**University Drive Lighting Upgrades
Contract No. BE21-092**

The Contract Documents may be obtained may be downloaded for free from the CBJ Engineering Department webpage at: www.juneau.org/engineering-public-works.

PRE-BID CONFERENCE. Prospective Bidders are encouraged to attend a pre-Bid conference to discuss the proposed WORK, which will be conducted by the CBJ Engineering Department, at 10:00 a.m. on February 10, 2021. The object of the conference is to acquaint Bidders with the project and bid documents. Conference call capability will be available for the Pre-Bid meeting. Prospective bidders intending to participate shall email contracts@juneau.org by 4:30 p.m., February 9, 2021, to obtain the call-in instructions.

DESCRIPTION OF WORK. The WORK covered in the Contract Documents generally includes: Replacing existing concrete footing with new precast concrete footing, removal of existing junction boxes and replacing with 27 new concrete junction boxes, removal of existing light poles and light fixtures and replacing with new light poles and light fixtures. The WORK also includes replacing existing lighting circuit with all new conductors and installation of new 1.5 inch underground PVC conduit between concrete junction box and concrete footing and University Drive lighting system power.

COMPLETION OF WORK. The WORK must be completed by August 27, 2021.

DEADLINE FOR BIDDER QUESTIONS: February 16, 2021

DEADLINE FOR BIDS: DEADLINE FOR BIDS: Sealed bids must be received by the Purchasing Division **prior to 2:00 p.m., Alaska Time on February 23, 2021** or such later time as may be announced by addendum at any time prior to the deadline. Bids will be time and date stamped by the Purchasing Division, which will establish the official time of receipt of bids. Bids will be opened immediately thereafter via Teleconference. Bidders may attend this bid opening by calling 907-713-2140, with participant code 258358.

Bid documents delivered in person or by **courier** service must be delivered to:

Bid documents delivered by **U.S. Postal Service** must be mailed to:

PHYSICAL LOCATION:

City and Borough of Juneau, Purchasing Division
105 Municipal Way, Room 300
Juneau, AK 99801

MAILING ADDRESS:

City and Borough of Juneau, Purchasing Division
155 South Seward Street
Juneau, AK 99801

*** A face covering must be worn in the
105 Municipal Way building per the
CBJ Emergency Ordinance No. 2020-45**

SECTION 00030 NOTICE INVITING BIDS

Please affix the label below to outer envelope in the lower left hand corner.

IMPORTANT NOTICE TO BIDDER		
To submit your Bid:		
1. Print your company name and address on the upper left corner of your envelope.		
2. Complete this label and place it on the lower left corner of your envelope.		
S E A L E D	BID NUMBER: _____ BE21-092 _____	B I D
	SUBJECT: _____ UNIVERSITY DRIVE LIGHTING _____	
	UPGRADES _____	
	DEADLINE DATE: _____	
	PRIOR TO 2:00PM ALASKA TIME	

Mailing/delivery times to Alaska may take longer than other areas of the U.S. Late bids will not be accepted and will be returned.

SITE OF WORK. The site of the WORK is University Drive, access road to UAS Housing in the Auke Bay area of Juneau, Alaska.

BIDDING, CONTRACT, or TECHNICAL QUESTIONS. All communications relative to this WORK, prior to opening Bids, shall be directed to the following:

Greg Smith, Contract Administrator
CBJ Engineering Department, 3rd Floor, Marine View Center
Email: greg.smith@juneau.org
Telephone: (907) 586-0873
Fax: (907) 586-4530

BID SECURITY. Each Bid shall be accompanied by a certified or cashier's check or Bid Bond, in the amount of 5% percent of the Bid, payable to the City and Borough of Juneau, Alaska, as a guarantee that the Bidder, if its Bid is accepted, will promptly execute the Agreement. A Bid shall not be considered unless one of the forms of Bidder's security is enclosed with it.

CONTRACTOR'S LICENSE. All contractors are required to have a current Alaska Contractor's License, prior to submitting a Bid, and a current Alaska Business License prior to award.

BID TO REMAIN OPEN. The Bidder shall guarantee the Bid for a period of 120 Days from the date of Bid opening. Any component of the Bid may be awarded anytime during the 120 Days.

SECTION 00030 NOTICE INVITING BIDS

OWNER'S RIGHTS RESERVED. The OWNER reserves the right to reject any or all Bids, to waive any informality in a Bid, and to make award to the lowest responsive, responsible Bidder as it may best serve the interests of the OWNER.

OWNER: City and Borough of Juneau

By:  _____ Date 1/27/2021
Greg Smith, Contract Administrator

END OF SECTION

SECTION 00100 - INSTRUCTIONS TO BIDDERS

1.0 DEFINED TERMS. Terms used in these Instructions to Bidders and the Notice Inviting Bids, which are defined in the General Conditions, have the meanings assigned to them in the General Conditions. The term "Bidder" means one who submits a Bid directly to the OWNER, as distinct from a sub-bidder, who submits a Bid to a Bidder.

2.0 INTERPRETATIONS AND ADDENDA.

A. **INTERPRETATIONS.** All questions about the meaning or intent of the Contract Documents are to be directed to the Engineering Contracts Administrator. Interpretations or clarifications considered necessary by the Engineering Contracts Administrator in response to such questions will be issued by Addendum, mailed, faxed, or delivered to all parties recorded by the Engineering Contracts Administrator, or OWNER, as having received the Contract Documents. Questions received less than seven Days prior to the Deadline for Bids may not be answered. Only questions answered by formal written Addendum will be binding. Oral and other interpretations or clarifications will be without legal effect.

B. **ADDENDA.** Addenda may be issued to modify the Contract Documents as deemed advisable by the OWNER. Addenda may be faxed or, if addendum format warrants, addenda may be posted to the CBJ Engineering Department website. In any event, notification of addendum issuance will be faxed to planholders. Hard copies are available upon request. The OWNER will make all reasonable attempts to ensure that all planholders receive notification of Addenda, however, it is strongly recommended by the OWNER that bidders independently confirm the contents, number, and dates of each Addendum prior to submitting a Bid.

3.0 FAIR COMPETITION. More than one Bid from an individual, firm, partnership, corporation, or association under the same or different names will not be considered. If the OWNER believes that any Bidder is interested in more than one Bid for the WORK contemplated, all Bids in which such Bidder is interested will be rejected. If the OWNER believes that collusion exists among the Bidders, all Bids will be rejected.

4.0 RESPONSIBILITY OF BIDDERS. Only responsive Bids from responsible Bidders will be considered. A Bid submitted by a Bidder determined to be not responsible may be rejected. The OWNER may find a bidder to be not responsible for any one of the following reasons, but is not limited in its responsibility analysis to the following factors:

- A. Evidence of bid rigging or collusion;
- B. Fraud or dishonesty in the performance of previous contracts;
- C. Record of integrity;
- D. More than one bid for the same work from an individual, firm, or corporation under the same or different name;
- E. Unsatisfactory performance on previous or current contracts;
- F. Failure to pay, or satisfactorily settle, all bills due for labor and material on previous contracts;

SECTION 00100 - INSTRUCTIONS TO BIDDERS

- G. Uncompleted work that, in the judgment of the OWNER, might hinder or prevent the bidder's prompt completion of additional work, if awarded;
- H. Failure to reimburse the OWNER for monies owed on any previous contracts;
- I. Default under previous contracts;
- J. Failure to comply with any qualification requirements of the OWNER; special standards for responsibility, if applicable, will be specified. These special standards establish minimum standards or experience required for a responsible Bidder on a specific contract;
- K. Engaging in any activity that constitutes a cause for debarment or suspension under the CBJ Procurement Code 53.50 or submitting a bid during a period of debarment;
- L. Lack of skill, ability, financial resources, or equipment required to perform the contract; or
- M. Lack of legal capacity to contract.
- N. Bidders must be registered as required by law and in good standing for all amounts owed to the OWNER per Paragraph 21.0 of this Section.
- O. Failure to submit all completed documents as required and specified on the Bid Form, Section 00300.

Nothing contained in this section deprives the OWNER of its discretion in determining the lowest responsible bidder. Before a Bid is considered for award, a Bidder may be requested to submit information documenting its ability and competency to perform the WORK, according to general standards of responsibility and any special standards which may apply. It is Bidder's responsibility to submit sufficient, relevant, and adequate information. OWNER will make its determination of responsibility and has no obligation to request clarification or supplementary information.

5.0 NON-RESPONSIVE BIDS. Only responsive Bids will be considered. Bids may be considered non-responsive and may be rejected. Some of the reasons a Bid may be rejected for being non-responsive are:

- A. If a Bid is received by the CBJ Purchasing Division after the Deadline for Bids.
- B. If the Bid is on a form other than that furnished by the OWNER, or legible copies thereof; or if the form is altered or any part thereof is detached; or if the Bid is improperly signed.
- C. If there are unauthorized additions, conditional or alternate Bids, or irregularities of any kind which may tend to make the bid incomplete, indefinite, ambiguous as to its meaning, or in conflict with the OWNER's Bid document.
- D. If the Bidder adds any unauthorized conditions, limitations, or provisions reserving the right to accept or reject any award, or to enter into a contract pursuant to an award. This does not exclude a Bid limiting the maximum gross amount of awards acceptable to any one Bidder at any one Bid opening, provided that any selection of awards will be made by the OWNER.
- E. If the Bid does not contain a Unit Price for each pay item listed, except in the case of

SECTION 00100 - INSTRUCTIONS TO BIDDERS

authorized alternate pay items.

- F. If the Bidder has not acknowledged receipt of each Addendum.
- G. If the Bidder fails to furnish an acceptable Bid guaranty with the Bid.
- H. If any of the Unit Prices Bid are excessively unbalanced (either above or below the amount of a reasonable Bid) to the potential detriment of the OWNER.
- I. If a Bid modification does not conform to Article 15.0 of this Section.

6.0 BIDDER'S EXAMINATION OF CONTRACT DOCUMENTS AND SITE. It is the responsibility of each Bidder before submitting a Bid:

- A. To examine thoroughly the Contract Documents, and other related data identified in the Bidding documents (including "technical data" referred to below):
 - 1. To visit the site to become familiar with and to satisfy the Bidder as to the general and local conditions that may affect cost, progress, or performance, of the WORK,
 - 2. To consider federal, state and local laws and regulations that may affect cost, progress, or performance of the WORK,
 - 3. To study and carefully correlate the Bidder's observations with the Contract Documents, and other related data; and
 - 4. To notify the ENGINEER of all conflicts, errors, or discrepancies in or between the Contract Documents and such other related data.

7.0 REFERENCE IS MADE TO THE SUPPLEMENTARY GENERAL CONDITIONS FOR IDENTIFICATION OF:

- A. Those reports of explorations and tests of subsurface conditions at the site which have been utilized by the Engineer of Record in the preparation of the Contract Documents. The Bidder may rely upon the accuracy of the technical data contained in such reports, however, the interpretation of such technical data, including any interpolation or extrapolation thereof, together with non-technical data, interpretations, and opinions contained therein or the completeness thereof is the responsibility of the Bidder.
- B. Those Drawings of physical conditions in or relating to existing surface and subsurface conditions (except underground utilities) which are at or contiguous to the site have been utilized by the Engineer of Record in the preparation of the Contract Documents. The Bidder may rely upon the accuracy of the technical data contained in such Drawings, however, the interpretation of such technical data, including any interpolation or extrapolation thereof, together with nontechnical data, interpretations, and opinions contained in such Drawings or the completeness thereof is the responsibility of the Bidder.
- C. Copies of such reports and Drawings will be made available by the OWNER to any Bidder on request if said reports and Drawings are not bound herein. Those reports and Drawings are not part of the Contract Documents, but the technical data contained therein upon which the Bidder is entitled to rely, as provided in Paragraph SGC-4.2 of the Supplementary General Conditions, are incorporated herein by reference.

SECTION 00100 - INSTRUCTIONS TO BIDDERS

- D. Information and data reflected in the Contract Documents with respect to underground utilities at or contiguous to the site is based upon information and data furnished to the OWNER and the Engineer of Record by the owners of such underground utilities or others, and the OWNER does not assume responsibility for the accuracy or completeness thereof unless it is expressly provided otherwise in the Supplementary General Conditions, or in Section 01530 - Protection and Restoration of Existing Facilities of the General Requirements.
- E. Provisions concerning responsibilities for the adequacy of data furnished to prospective Bidders on subsurface conditions, underground utilities and other physical conditions, and possible changes in the Contract Documents due to differing conditions appear in Paragraphs 4.2, 4.3, and 4.4 of the General Conditions.
- F. Before submitting a Bid, each Bidder will, at Bidder's own expense, make or obtain any additional examinations, investigations, explorations, tests, and studies and obtain any additional information and data which pertain to the physical conditions (surface, subsurface, and underground utilities) at or contiguous to the site or otherwise which may affect cost, progress, or performance of the WORK and which the Bidder deems necessary to determine its Bid for performing the WORK in accordance with the time, price, and other terms and conditions of the Contract Documents.
- G. On request in advance, the OWNER will provide each Bidder access to the site to conduct such explorations and tests as each Bidder deems necessary for submission of a Bid. Bidder shall fill all holes and shall clean up and restore the site to its former condition upon completion of such explorations.
- H. The lands upon which the WORK is to be performed, rights-of-way and easements for access thereto and other lands designated for use by the CONTRACTOR in performing the WORK are identified in the Contract Documents. All additional lands and access thereto required for temporary construction facilities or storage of materials and equipment are to be provided by the CONTRACTOR. Easements for permanent structures or permanent changes in existing structures are to be obtained and paid for by the OWNER unless otherwise provided in the Contract Documents.
- I. The submission of a Bid will constitute an incontrovertible representation by the Bidder that the Bidder has complied with every requirement of Article 6.0, "Bidder's Examination of Contract Documents and Site" herein, that without exception the Bid is premised upon performing the WORK required by the Contract Documents and such means, methods, techniques, sequences, or procedures of construction as may be indicated in or required by the Contract Documents, and that the Contract Documents are sufficient in scope and detail to indicate and convey understanding of all terms and conditions for performance of the WORK.

8.0 BID FORM.

- A. The Bid shall be made on the Bid Schedule(s) bound herein, or on the yellow Bid packet provided, or on legible and complete copies thereof, and shall contain the following: Sections 00300, 00310, the required Bid Security, and any other documents required in Section 00300 – Bid.
- B. All blanks on the Bid Form and Bid Schedule must be completed in ink or typed.

SECTION 00100 - INSTRUCTIONS TO BIDDERS

- C. Bids by corporations must be executed in the corporate name by the president, a vice-president (or other corporate officer). The corporate address and state of incorporation must appear below the signature.
- D. Bids by partnerships must be executed in the partnership name and be signed by a managing partner, and the official address of the partnership must appear below the signature.
- E. The Bidder's Bid must be signed. All names must be printed or typed below the signature.
- F. The Bid shall contain an acknowledgment of receipt of all Addenda, the numbers of which shall be filled in on the Bid form. Failure to acknowledge Addenda may render Bid non-responsive and may cause its rejection.
- G. The address to which communications regarding the Bid are to be directed must be shown.

9.0 QUANTITIES OF WORK. The quantities of WORK, or material, stated in Unit Price items of the Bid are supplied only to give an indication of the general scope of the WORK; the OWNER does not expressly or by implication agree that the actual amount of WORK, or material, will correspond therewith, and reserves the right after award to increase or decrease the amount of any Unit Price item of the WORK by an amount up to and including 25 percent of any Bid item, without a change in the Unit Price, and shall include the right to delete any Bid item in its entirety, or to add additional Bid items up to and including an aggregate total amount not to exceed 25 percent of the Contract Price (see Section 00700 - General Conditions, Article 10 Changes In the WORK).

10.0 SUBSTITUTE OR "OR-EQUAL" ITEMS. Substitution requests are not accepted during the bidding process. The procedure for the submittal of substitute or "or-equal" products is specified in Section 01300 – Contractor Submittals.

11.0 SUBMISSION OF BIDS. The Bid shall be delivered by the time and to the place stipulated in Section 00030 - Notice Inviting Bids. It is the Bidder's sole responsibility to see that its Bid is received in proper time. Oral, telegraphic, emailed, or faxed Bids will not be considered. The envelope enclosing the sealed Bids shall be plainly marked in the upper left-hand corner with the name and address of the Bidder and shall also include the label included in Section 00030 – Notice Inviting Bids. The Bid Security shall be enclosed in the same envelope with the Bid

12.0 BID SECURITY, BONDS, AND INSURANCE. Each Bid shall be accompanied by a certified, or cashier's check, or approved Bid Bond in an amount of at least 5 percent of the total Bid price. The "total Bid price" is the amount of the Base Bid, plus the amount of alternate Bids, if any, which total to the maximum amount for which the CONTRACT could be awarded. Said check or Bond shall be made payable to the OWNER and shall be given as a guarantee that the Bidder, if offered the WORK, will enter into an Agreement with the OWNER, and will furnish the necessary insurance certificates, Payment Bond, and Performance Bond; each of said Bonds, if required, and insurance amounts shall be as stated in the Supplementary General Conditions. In case of refusal or failure to enter into said Agreement, the check or Bid Bond, as the case may be, may be forfeited to the OWNER. If the Bidder elects to furnish a Bid Bond as its Bid security, the Bidder shall use the Bid Bond form bound herein, or one conforming substantially to it in form. Bid Bonds must be accompanied by a legible Power of Attorney.

SECTION 00100 - INSTRUCTIONS TO BIDDERS

13.0 RETURN OF BID SECURITY. The OWNER will return all Bid security checks (certified or cashier's) accompanying such of the Bids as are not considered in making the award. All other Bid securities will be held until the Agreement has been executed. Following execution of the Agreement, all other Bid security checks will be returned to the respective Bidders whose Bids they accompanied and Bid security bonds will be appropriately discarded.

14.0 DISCREPANCIES IN BIDS. In the event there is more than one Pay Item in a Bid Schedule, the Bidder shall furnish a price for all Pay Items in the schedule, and failure to do so may render the Bid non-responsive and cause its rejection. In the event there are Unit Price Pay Items in a Bid Schedule and the "amount" indicated for a Unit Price Bid Item does not equal the product of the Unit Price and quantity, the Unit Price shall govern and the amount will be corrected accordingly, and the Bidder shall be bound by said correction. In the event there is more than one Pay Item in a Bid Schedule and the total indicated for the schedule does not agree with the sum of the prices Bid on the individual items, the prices Bid on the individual items shall govern and the total for the schedule will be corrected accordingly, and the Bidder shall be bound by said correction.

15.0 BID MODIFICATIONS AND UNAUTHORIZED ALTERNATIVE BIDS.

- A. Any bidder may deliver a modification to a bid in person, by mail or fax (907-586-4561), provided that such modification is received by the Purchasing Division no later than the deadline for bids. Modifications will be time and date stamped by the Purchasing Division, which will establish the official time of receipt of the modification. The modification must not reveal the bid price but should be in the form of an addition or subtraction or other modification so that the final prices will not be known until the sealed bid is opened.

The Bid modifications shall be provided on the **Bid Modification Form** located at the end of this Section. Submittal of any other form by the vendor may deem the modification unacceptable by the OWNER. **A mail or fax modification should not reveal the Bid price but should provide the addition or subtraction or other modification so that the final prices will not be known by the City and Borough until the sealed Bid is opened.** Submitted Modification forms shall include the modification to the unit price or lump sum amount of each pay item modified.

FAX DISCLAIMER: It is the responsibility of the bidder to submit modifications in a timely manner. Bidders' use of a fax machine to modify their bid shall be at bidders' sole risk. The Purchasing Division will attempt to keep the fax machine in good working order but will not be responsible for bid modifications that are late due to mechanical failure, a busy fax machine, or any other cause arising from bidder's use of a fax machine, even if bidder submits a transmission report or provides other confirmation indicating that the bidder transmitted a bid modification prior to the deadline. The City will not be responsible for its failure to receive the modification whether such failure is caused by equipment or human error, or otherwise. Bidders are therefore strongly encouraged to confirm receipt of their bid modification with the Purchasing Division (907-586-5258) prior to deadline.

- B. Conditioned bids, limitations, or provisos attached to the Bid or bid modification will render it unauthorized and cause its rejection as being non-responsive. The completed Bid forms shall be without interlineations, alterations, or erasures in the printed text. All changes shall be initialed by the person signing the Bid. Alternative Bids will not be considered unless called for.

SECTION 00100 - INSTRUCTIONS TO BIDDERS

16.0 WITHDRAWAL OF BID. Prior to the Deadline for Bids, the Bid may be withdrawn by the Bidder by means of a written request, signed by the Bidder or its properly authorized representative. Such written request must be delivered to the place stipulated in the Notice Inviting Bids for receipt of Bids.

17.0 AWARD OF CONTRACT.

- A. Award of a contract, if it is awarded, will be on the basis of materials and equipment described in the Drawings or specified in the Technical Specifications and will be made to the lowest responsive, responsible Bidder whose Bid complies with all the requirements prescribed. Unless otherwise specified, any such award will be made within the period stated in the Notice Inviting Bids that the Bids are to remain open. Unless otherwise indicated, a single award will be made for all the Bid items in an individual Bid Schedule.
- B. If the OWNER has elected to advertise this Project with a Base Bid and Alternates, the OWNER may elect to award the contract for the Base Bid, or the Base Bid in combination with one or more Alternates selected by the OWNER. In either case, award shall be made to the responsive, responsible bidder offering the lowest total Bid for the WORK to be awarded.

C.

18.0 EXECUTION OF AGREEMENT.

- A. All Bids of value greater than \$1,000,000 must be approved by the CBJ Assembly. After the CBJ Assembly has approved the award and after the Bid protest period, the OWNER will issue a Notice of Intent to Award to the approved Bidder. The Bidder to whom award is made shall execute a written Agreement with the OWNER on the Agreement form, Section 00500, collect insurance, and shall furnish all certificates and Bonds required by the Contract Documents within 10 Days (calendar) from the date of the Notice of Intent to Award letter.
- B. Failure or refusal to enter into the Agreement as herein provided or to conform to any of the stipulated requirements in connection therewith shall be just cause for annulment of the award and forfeiture of the Bid security. If the lowest responsive, responsible Bidder refuses or fails to execute the Agreement, the OWNER may award the contract to the second lowest responsive, responsible Bidder. If the second lowest responsive, responsible Bidder refuses or fails to execute the Agreement, the OWNER may award the contract to the third lowest responsive, responsible Bidder. On the failure or refusal of such second or third lowest Bidder to execute the Agreement, each such Bidder's Bid securities shall be likewise forfeited to the OWNER.

19.0 LIQUIDATED DAMAGES. Provisions for liquidated damages if any, are set forth in Section 00500 - Agreement.

20.0 FILING A PROTEST.

- A. A Bidder may protest the proposed award of a competitive sealed Bid by the City and Borough of Juneau. The protest shall be executed in accordance with CBJ Ordinance

SECTION 00100 - INSTRUCTIONS TO BIDDERS

53.50.062 PROTESTS and CBJ Ordinance 53.50.080 ADMINISTRATION OF PROTEST. The entire text of the CBJ Purchasing Ordinance can be accessed at the CBJ website, <http://www.juneau.org/law/code/code.php>, or call the CBJ Purchasing Division at (907) 586-5258 for a copy of the ordinance.

B. Late protests shall not be considered by the CBJ Purchasing Officer.

21.0 CONTRACTOR'S GOOD STANDING WITH CBJ FINANCE DEPARTMENT: Contractors must be in good standing with the CBJ prior to award, and prior to any contract renewals, and in any event no later than *seven business days* following notification by the CBJ of intent to award. **Good standing** means: all amounts owed to the CBJ are current and the Contractor is not delinquent with respect to any taxes, fees, assessment, or other monies due and owed the CBJ, or a Confession of Judgment has been executed and the Contractor is in compliance with the terms of any stipulation associated with the Confession of Judgment, including being current as to any installment payments due; and Contractor is current in all CBJ reporting obligations (such as sales tax registration and reporting and business personal property declarations). Failure to meet these requirements may be cause for rejection of your bid. To determine if your business is in good standing, or for further information, contact the CBJ Finance Department's Sales Tax Division at (907) 586-5265 for sales tax issues, Assessor's Office at (907)586-0930 for business personal property issues, or Collections Division at (907) 586-5268 for all other accounts.

22.0 PERMITS AND LICENSES. The CONTRACTOR is responsible for all WORK associated with meeting any local, state, and/or federal permit and licensing requirements.

SECTION 00100 - INSTRUCTIONS TO BIDDERS

CITY AND BOROUGH OF JUNEAU
PURCHASING DIVISION
FAX NO. 907-586-4561

BID MODIFICATION FORM

Modification Number: _____

Modification Page ____ of ____

Note: All modifications shall be made to the original bid amount(s). If more than one Modification form is submitted by any one bidder, changes from all Modification forms submitted will be combined and applied to the original bid. Changes to the modified Bid amounts will be calculated by the OWNER. Bidder may use multiple modification pages if required.

PAY ITEM NO.	PAY ITEM DESCRIPTION	MODIFICATIONS TO UNIT PRICE OR LUMP SUM (indicate +/-)

Base Bid Total Increase or Decrease: \$ _____

Name of Bidding Firm

Responsible Party Signature

Printed Name (must be an authorized signatory for Bidding Firm)

END OF SECTION

SECTION 00300 - BID

BID TO: THE CITY AND BOROUGH OF JUNEAU

1. The undersigned Bidder proposes and agrees, if this Bid is accepted, to enter into an Agreement with the OWNER on the form included in the Contract Documents (as defined in Article 7 of Section 00500 - Agreement) to perform the WORK as specified or indicated in said Contract Documents entitled

**University Drive Lighting Upgrades
Contract No. BE21-092**

2. Bidder accepts all of the terms and conditions of the Contract Documents, including without limitation those in the "Notice Inviting Bids" and "Instructions to Bidders," dealing with the disposition of the Bid Security.
3. This Bid will remain open for the period stated in the "Notice Inviting Bids" unless otherwise required by law. Bidder will enter into an Agreement within the time and in the manner required in the "Notice Inviting Bids" and the "Instructions to Bidders," and will furnish insurance certificates, Payment Bond, Performance Bond, and any other documents as may be required by the Contract Documents.
4. Bidder has familiarized itself with the nature and extent of the Contract Documents, WORK, site, locality where the WORK is to be performed, the legal requirements (federal, state and local laws, ordinances, rules, and regulations), and the conditions affecting cost, progress or performance of the WORK and has made such independent investigations as Bidder deems necessary.
5. This Bid is genuine and not made in the interest of or on behalf of any undisclosed person, firm or corporation and is not submitted in conformity with any agreement or rules of any group, association, organization or corporation; Bidder has not directly or indirectly induced or solicited any other Bidder to submit a false or sham Bid; Bidder has not solicited or induced any person, firm or corporation to refrain from bidding; and Bidder has not sought by collusion to obtain for itself any advantage over any other Bidder or over OWNER.
6. To all the foregoing, and including all Bid Schedule and information required of Bidder contained in this Bid Form, said Bidder further agrees to complete the WORK required under the Contract Documents within the Contract Time stipulated in said Contract Documents, and to accept in full payment therefore the Contract Price based on the total bid price(s) named in the aforementioned Bid Schedule.
7. Bidder has examined copies of all the Contract Documents including the following Addenda (receipt of all of which is hereby acknowledged by the Undersigned):

Addenda No.	Date Issued	Addenda No.	Date Issued

Give number and date of each Addenda above. Failure to acknowledge receipt of all Addenda may cause the Bid to be non-responsive and may cause its rejection.

SECTION 00300 - BID

8. The Bidder has read this Bid and agrees to the conditions as stated herein by signing its signature in the space provided below.

Dated: _____	Bidder: _____ (Company Name)
Alaska CONTRACTOR's Business License No: _____	By: _____ (Signature)
Alaska CONTRACTOR's License No: _____	Printed Name: _____ Title: _____
Telephone No: _____	Address: _____ (Street or P.O. Box)
Fax No: _____	_____ (City, State, Zip)
E-mail: _____	

9. **TO BE CONSIDERED, ALL BIDDERS MUST COMPLETE AND INCLUDE THE FOLLOWING AT THE TIME OF THE DEADLINE FOR BIDS. MISSING DOCUMENTS WILL DEEM THIS BID NON-RESPONSIVE:**

- Bid, Section 00300 (includes Addenda receipt statement)
- Completed Bid Schedule, Section 00310
- Bid Security (Bid Bond, Section 00320, or by a certified or cashier's check as stipulated in the Notice Inviting Bids, Section 00030)
- **Contractor Financial Responsibility, Section 00370**

10. The apparent low Bidder is required to complete and submit the following documents by 4:30 p.m. on the ***fifth business day*** following the date of the Posting Notice.

- Subcontractor Report, Section 00360

The apparent low Bidder who fails to submit the completed Subcontractor Report within the time specified in Section 00360 – Subcontractor Report, may be found to be not a responsible Bidder and may be required to forfeit the Bid security. The OWNER may then consider the next lowest Bidder for award of the contract.

11. The successful Bidder will be required to submit, ***within ten Days (calendar)*** after the date of the “Notice of Intent to Award” letter, the following executed documents:

- Agreement Forms, Section 00500
- Performance Bond, Section 00610
- Payment Bond, Section 00620
- Certificates of Insurance, (CONTRACTOR) Section 00700 and Section 00800

END OF SECTION

SECTION 00310 - BID SCHEDULE

PAY ITEM NO.	PAY ITEM DESCRIPTION	PAY UNIT	APPROX. QUANTITY	UNIT PRICE		AMOUNT	
				DOLLARS	CENTS	DOLLARS	CENTS
1505.1	Mobilization	Lump Sum	All Req'd	Lump	Sum		
1550.1	Traffic Control	Lump Sum	All Req'd	Lump	Sum		
Drawings	Demolition	Lump Sum	All Req'd	Lump	Sum		
1700.1	Project Closeout	Lump Sum	All Req'd	Lump	Sum		
Drawings	Landscaping	Lump Sum	All Req'd	Lump	Sum		
16060	Grounding and Bonding	Lump Sum	All Req'd	Lump	Sum		
16073	Hangars and Supports for Electrical Systems	Lump Sum	All Req'd	Lump	Sum		
16075	Electrical Identification	Lump Sum	All Req'd	Lump	Sum		
16120	Conductors and Cables	Lump Sum	All Req'd	Lump	Sum		
16130	Raceways and Boxes	Lump Sum	All Req'd	Lump	Sum		
16521	Exterior Lights and Poles	Lump Sum	All Req'd	Lump	Sum		
Drawings	Concrete Bases	Lump Sum	All Req'd	Lump	Sum		

COMPANY NAME: _____

TOTAL BID: _____

COMPANY NAME: _____

SECTION 00320 - BID BOND

KNOW ALL PERSONS BY THESE PRESENTS, that _____
_____ as Principal, and _____
as Surety, are held and firmly bound unto **THE CITY AND BOROUGH OF JUNEAU** hereinafter called
"OWNER," in the sum of _____
_____dollars, (not less than five percent of the total amount of the Bid) for the
payment of which sum, well and truly to be made, we bind ourselves, our heirs, executors, administrators,
successors, and assigns, jointly and severally, firmly by these presents.

WHEREAS, said Principal has submitted a Bid to said OWNER to perform the WORK required under
the Bid Schedule of the OWNER's Contract Documents entitled.

**University Drive Lighting Upgrades
Contract No. BE21-092**

NOW THEREFORE, if said Principal is awarded a contract by said OWNER and, within the time and
in the manner required in the "Notice Inviting Bids" and the "Instructions to Bidders" enters into a written
Agreement on the form of Agreement bound with said Contract Documents, furnishes the required certificates
of insurance, and furnishes the required Performance Bond and Payment Bond, then this obligation shall be
null and void, otherwise it shall remain in full force and effect. In the event suit is brought upon this bond by
said OWNER and OWNER prevails, said Surety shall pay all costs incurred by said OWNER in such suit,
including a reasonable attorney's fee to be fixed by the court.

SIGNED AND SEALED, this _____ day of _____, 20____

(SEAL) _____
(Principal)

(SEAL) _____
(Surety)

By: _____
(Signature)

By: _____
(Signature)

END OF SECTION

SECTION 00360 - SUBCONTRACTOR REPORT

LIST OF SUBCONTRACTORS (AS 36.30.115)

The apparent low Bidder must submit a list of Subcontractors that the Bidder proposes to use in the performance of this contract *on the fifth business day* following the Posting Notice of Bids. If the fifth day falls on a weekend or holiday, the report is due by close of business on the next business Day following the weekend or holiday. The Subcontractor Report list must include each Subcontractor's name, address, location, evidence of valid Alaska Business License, and valid Alaska Contractor's Registration under AS 08.18. *If no Subcontractors are to be utilized in the performance of the WORK, write in ink or type "NONE" on line (1) below.*

<u>SUBCONTRACTOR</u>	¹ AK Contractor License No.	¹ Contact Name	Type of	Contract	✓ if DBE
<u>ADDRESS</u>	² AK Business License No.	² Phone No.	<u>Work</u>	<u>Amount</u>	
1. _____ _____ _____	1 _____ 2 _____	_____ _____	_____ _____	\$ _____	<input type="checkbox"/>
2. _____ _____ _____	1 _____ 2 _____	_____ _____	_____ _____	\$ _____	<input type="checkbox"/>
3. _____ _____ _____	1 _____ 2 _____	_____ _____	_____ _____	\$ _____	<input type="checkbox"/>
4. _____ _____ _____	1 _____ 2 _____	_____ _____	_____ _____	\$ _____	<input type="checkbox"/>

I certify that the above listed Alaska Business License(s) and CONTRACTOR Registration(s), if applicable, were valid at the time Bids were opened for this Project.

CONTRACTOR, Authorized Signature

CONTRACTOR, Printed Name

COMPANY

SECTION 00360 - SUBCONTRACTOR REPORT

- A. A Bidder may replace a listed Subcontractor if the Subcontractor:
1. fails to comply with AS 08.18;
 2. files for bankruptcy or becomes insolvent;
 3. fails to execute a contract with the Bidder involving performance of the WORK for which the Subcontractor was listed and the Bidder acted in good faith;
 4. fails to obtain bonding;
 5. fails to obtain insurance acceptable to the OWNER;
 6. fails to perform the contract with the Bidder involving work for which the Subcontractor was listed;
 7. must be substituted in order for the CONTRACTOR to satisfy required state and federal affirmative action requirements;
 8. refuses to agree or abide with the Bidder's labor agreement; or
 9. is determined by the OWNER not to be responsible.
 10. is not in "Good Standing" with the OWNER as required in Article 21.0 in Section 00100 – Instructions to Bidders.
- B. If a Bidder fails to list a Subcontractor or lists more than one Subcontractor for the same portion of WORK, the Bidder shall be considered to have agreed to perform that portion of WORK without the use of a Subcontractor and to have represented the Bidder to be qualified to perform that WORK.
- C. A Bidder who attempts to circumvent the requirements of this section by listing as a Subcontractor another contractor who, in turn, sublets the majority of the WORK required under the contract violates this section.
- D. If a contract is awarded to a Bidder who violates this section, the OWNER may:
1. cancel the contract; or
 2. after notice and a hearing, assess a penalty on the Bidder in an amount that does not exceed 10 percent of the value of the subcontract at issue.
- E. On the Subcontractor Report, the apparent low Bidder must list all Subcontractors anticipated to perform WORK on the project.
- F. An apparent low Bidder who fails to submit a completed Subcontractor Report within the time specified in this section may be found to be not a responsible Bidder and may be required to forfeit the Bid security. The OWNER will then consider the next lowest Bidder for award of the contract.

END OF SECTION

SECTION 00370 - CONTRACTOR'S FINANCIAL RESPONSIBILITY

To be considered, all bidders must complete and include this form *at the time of the deadline for bids*. Attach additional sheets as necessary to respond to questions.

PROJECT: UNIVERSITY DRIVE LIGHTING UPGRADES

As the General Contractor on this project, I intend to subcontract _____% of the total value of this contract.

A. EXPERIENCE

1. Have you ever failed to complete a contract due to insufficient resources?

No Yes If YES, explain:

2. Describe arrangements you have made to finance this work:

3. Have you had previous construction contracts or subcontracts with the City and Borough of Juneau?

Yes No

4. Describe your most recent or current contract, its completion date, and scope of work:

5. List below, and/or as an attachment to this questionnaire, other construction projects you have completed, dates of completion, scope of work, and total contract amount for each project completed in the past twelve months.

SECTION 00370 - CONTRACTOR'S FINANCIAL RESPONSIBILITY

6. Per Alaska Statute 36.90.210, on previously awarded public contracts (including contracts still in progress), have you ever failed to pay a subcontractor or material supplier **within eight working days** after receiving payment from the Owner (for projects occurring within the last 3 years)?

Yes No If yes, please attach a detailed explanation for **each** occurrence.

B. EQUIPMENT

1. Describe below, and/or as an attachment, the equipment you have available and intend to use for this project.

ITEM	QUANTITY	MAKE	MODEL	SIZE/CAPACITY	PRESENT MARKET VALUE

2. Do you propose to purchase any equipment for use on this project not listed on table B-1?

No Yes If YES, describe type, quantity, and approximate cost:

3. Do you propose to rent any equipment for this work not listed on table B-1?

No Yes If YES, describe type and quantity:

SECTION 00370 - CONTRACTOR'S FINANCIAL RESPONSIBILITY

4. Is your bid based on firm offers for all materials necessary for this project?

Yes No If NO, please explain:

I hereby certify that the above statements are true and complete.

Contractor Signature

Name and Title of Person Signing

Signature

Date

SECTION 00500 - AGREEMENT

THIS AGREEMENT is between THE CITY AND BOROUGH OF JUNEAU (hereinafter called OWNER) and _____ (hereinafter called CONTRACTOR) OWNER and CONTRACTOR, in consideration of the mutual covenants hereinafter set forth, agree as follows:

ARTICLE 1. WORK.

CONTRACTOR shall complete the WORK as specified or as indicated under the Bid Schedule of the OWNER's Bid Documents entitled **Contract No. BE21-092 UNIVERSITY DRIVE LIGHTING UPGRADES.**

The WORK is generally described as follows: Replacing existing concrete footing with new precast concrete footing, removal of existing junction boxes and replacing with 27 new concrete junction boxes, removal of existing light poles and light fixtures and replacing with new light poles and light fixtures. The WORK also includes replacing existing lighting circuit with all new conductors and installation of new 1.5 inch underground PVC conduit between concrete junction box and concrete footing and University Drive lighting system power, and miscellaneous related WORK.

The WORK to be paid under this contract shall include the following: Total Bid as shown in Section 00310 - Bid Schedule.

ARTICLE 2. CONTRACT COMPLETION TIME. The WORK must be completed by August 27, 2021.

ARTICLE 3. DATE OF AGREEMENT

The date of this Agreement will be the date of the last signature on page three of this section.

ARTICLE 4. LIQUIDATED DAMAGES.

OWNER and the CONTRACTOR recognize that time is of the essence of this Agreement and that the OWNER will suffer financial loss if the WORK is not completed within the time specified in Article 2 herein, plus any extensions thereof allowed in accordance with Article 12 of the General Conditions. They also recognize the delays, expense, and difficulties involved in proving in a legal proceeding the actual damages suffered by the OWNER if the WORK is not completed on time. Accordingly, instead of requiring any such proof, the OWNER and the CONTRACTOR agree that as liquidated damages for delay (but not as a penalty) the CONTRACTOR shall pay the OWNER **\$1,000.00** for each Day that expires after the completion time specified in Article 2 herein. The amount of liquidated damages specified above is agreed to be a reasonable estimate based on all facts known as of the date of this Agreement.

ARTICLE 5. CONTRACT PRICE.

OWNER shall pay CONTRACTOR for completion of the WORK in accordance with the Contract Documents in the amount set forth in the Bid Schedule. The CONTRACTOR agrees to accept as full and complete payment for all WORK to be done in this contract for: **Contract No. BE21-092 University Drive Lighting Upgrades** those Unit Price amounts as set forth in the Bid Schedule in the Contract Documents for this Project.

The total amount of this contract shall be _____ (\$ _____), except as adjusted in accordance with the provisions of the Bid Documents.

SECTION 00500 - AGREEMENT

ARTICLE 6. PAYMENT PROCEDURES.

CONTRACTOR shall submit Applications for Payment in accordance with Article 14 of the General Conditions. Applications for Payment will be processed by the ENGINEER as provided in the General Conditions.

Progress payments will be paid in full in accordance with Article 14 of the General Conditions until ninety (90) percent of the Contract Price has been paid. The remaining ten (10) percent of the Contract Price may be retained, in accordance with applicable Alaska State Statutes, until final inspection, completion, and acceptance of the Project by the OWNER.

ARTICLE 7. CONTRACT DOCUMENTS.

The Contract Documents which comprise the entire Agreement between OWNER and CONTRACTOR concerning the WORK consist of this Agreement (pages 00500-1 to 00500-6, inclusive) and the following sections of the Contract Documents:

- Table of Contents (pages 00005-1 to 00005-2, inclusive)
- Notice Inviting Bids (pages 00030-1 to 00030-2, inclusive).
- Instructions to Bidders (pages 00100-1 to 00100-9, inclusive).
- Bid (pages 00300-1 to 00300-2, inclusive).
- Bid Schedule (pages 00310-1, inclusive).
- Bid Bond (page 00320-1, inclusive) or Bid Security.
- Subcontractor Report (pages 00360-1 to 00360-2, inclusive).
- Contractor Financial Responsibility (pages 00370-1 to 00370-3, inclusive).
- Performance Bond (pages 00610-1 to 00610-2, inclusive).
- Payment Bond (pages 00620-1 to 00620-2, inclusive).
- Insurance Certificate(s).
- General Conditions (pages 00700-1 to 00700-48, inclusive).
- Supplementary General Conditions (pages 00800-1 to 00800-5, inclusive).
- Alaska Labor Standards, Reporting, and Prevailing Wage Determination (page 00830-1).
- Permits, (page 00852-1).
- Standard Details (page 00853-1).
- Special Provisions (pages 1 to 40 inclusive)
- Drawings consisting of 7 sheets, as listed in the Table of Contents.
- Addenda numbers _____ to _____, inclusive.
- Change Orders which may be delivered or issued after the Date of the Agreement and which are not attached hereto.

There are no Contract Documents other than those listed in this Article 7. The Contract Documents may only be amended by Change Order as provided in Paragraph 3.3 of the General Conditions.

ARTICLE 8. MISCELLANEOUS.

Terms used in this Agreement which are defined in Article 1 of the General Conditions will have the meanings indicated in the General Conditions.

SECTION 00500 - AGREEMENT

ARTICLE 8. MISCELLANEOUS. (Cont'd.)

No assignment by a party hereto of any rights under or interests in the Contract Documents will be binding on another party hereto without the written consent of the party sought to be bound; and specifically but without limitation monies that may become due and monies that are due may not be assigned without such consent (except to the extent that the effect of this restriction may be limited by law), and unless specifically stated to the contrary in any written consent to an assignment, no assignment will release or discharge the assignor from any duty or responsibility under the Contract Documents.

OWNER and CONTRACTOR each binds itself, its partners, successors, assigns and legal representatives to the other party hereto, its partners, successors, assigns and legal representatives in respect of all covenants, agreements and obligations contained in the Contract Documents. This Agreement shall be governed by the laws of the State of Alaska. Jurisdiction shall be in the State of Alaska, First Judicial District.

IN WITNESS WHEREOF, OWNER and CONTRACTOR have caused this Agreement to be executed on the date listed below by OWNER.

OWNER:

CONTRACTOR:

City and Borough of Juneau

(Company Name)

(Signature)

(Signature)

By: Duncan Rorie Watt, City & Borough Manager
(Printed Name)

By: _____
(Printed Name, Authority or Title)

Date: _____

CONTRACTOR Signature Date: _____

OWNER's address for giving notices:

CONTRACTOR's address for giving notices:

155 South Seward Street

Juneau, Alaska 99801

907-586-0873 907-586-4530
(Telephone) (Fax)

(Telephone) (Fax)

(E-mail address)

Contractor License No. _____

SECTION 00500 - AGREEMENT

**CERTIFICATE
(if Corporation)**

STATE OF)
) SS:
COUNTY OF)

I HEREBY CERTIFY that a meeting of the Board of Directors of the
_____ a corporation existing under the laws of
the State of _____, held on _____, 20____, the following resolution
was duly passed and adopted:

“RESOLVED, that _____, as _____ President
of the Corporation, be and is hereby authorized to **execute the Agreement** with the CITY AND
BOROUGH OF JUNEAU and this corporation and that the execution thereof, attested by the
Secretary of the Corporation, and with the Corporate Seal affixed, shall be the official act and deed
of this Corporation.”

I further certify that said resolution is now in full force and effect.

IN WITNESS WHEREOF, I have hereunto set my hand and affixed the official seal of the
corporation this _____ day of _____, 20_____.

Secretary

(SEAL)

SECTION 00500 - AGREEMENT

CERTIFICATE
(if Partnership)

STATE OF)
) SS:
COUNTY OF)

I HEREBY CERTIFY that a meeting of the Partners of the

_____ a partnership existing under the laws of the State

of _____, held on _____, 20____, the following resolution was duly passed and adopted:

"RESOLVED, that _____, as _____ of the Partnership, be and is hereby authorized to **execute the Agreement** with the CITY AND BOROUGH OF JUNEAU and this partnership and that the execution thereof, attested by the _____ shall be the official act and deed of this Partnership."

I further certify that said resolution is now in full force and effect.

IN WITNESS WHEREOF, I have hereunto set my hand this _____, day of _____, 20_____.

Secretary

(SEAL)

SECTION 00500 - AGREEMENT

**CERTIFICATE
(if Joint Venture)**

STATE OF)
) SS:
COUNTY OF)

I HEREBY CERTIFY that a meeting of the Principals of the
_____ a joint venture existing under the laws of the
State of _____, held on _____, 20____, the following resolution was duly passed and
adopted:

"RESOLVED, that _____, as _____ of the
Joint Venture, be and is hereby authorized to **execute the Agreement** with the CITY AND
BOROUGH OF JUNEAU and this joint venture and that the execution thereof, attested by the
_____ shall be the official act and deed of this Joint Venture."

I further certify that said resolution is now in full force and effect.

IN WITNESS WHEREOF, I have hereunto set my hand this _____, day of
_____, 20____.

Secretary

(SEAL)

END OF SECTION

SECTION 00610 - PERFORMANCE BOND

KNOW ALL PERSONS BY THESE PRESENTS: That we _____
(Name of Contractor)

_____ a _____
(Corporation, Partnership, Individual)

hereinafter called "Principal" and _____
(Surety)

of _____, State of _____ hereinafter called the "Surety," are held and
firmly bound to the CITY AND BOROUGH of JUNEAU, ALASKA hereinafter called "OWNER,"
(Owner) (City and State)

for the penal sum of _____

_____ dollars (\$ _____) in lawful money of the
United States, for the payment of which sum well and truly to be made, we bind ourselves, our heirs, executors,
administrators and successors, jointly and severally, firmly by these presents.

THE CONDITION OF THIS OBLIGATION is such that whereas, the CONTRACTOR has entered
into a certain contract with the OWNER, the effective date of which is (CBJ Contracts Office to fill in effective
date) _____, a copy of which is hereto attached and made a part hereof for the
construction of:

**University Drive Lighting Upgrades
CBJ Contract No. BE21-092**

NOW, THEREFORE, if the Principal shall truly and faithfully perform its duties, all the undertakings,
covenants, terms, conditions, and agreements of said contract during the original term thereof, and any
extensions thereof, which may be granted by the OWNER, with or without notice to the Surety, and if it shall
satisfy all claims and demands incurred under such contract, and shall fully indemnify and save harmless the
OWNER from all costs and damages which it may suffer by reason of failure to do so, and shall reimburse and
repay the OWNER all outlay and expense which the OWNER may incur in making good any default, then this
obligation shall be void; otherwise to remain in full force and effect.

PROVIDED, FURTHER, that the said Surety, for value received hereby stipulates and agrees that no
change, extension of time, alteration or addition to the terms of the contract or to the WORK to be performed
thereunder or the specifications accompanying the same shall in any wise affect its obligation on this bond, and
it does hereby waive notice of any such change, extension of time, alteration or addition to the terms of the
contract or to the WORK or to the Specifications.

PROVIDED, FURTHER, that no final settlement between the OWNER and the Principal shall abridge
the right of any beneficiary hereunder, whose claim may be unsatisfied.

SECTION 00610 - PERFORMANCE BOND

**University Drive Lighting Upgrades
CBJ Contract No. BE21-092**

IN WITNESS WHEREOF, this instrument is issued in two (2) identical counterparts, each one of which shall be deemed an original.

CONTRACTOR:

By: _____
(Signature)

(Printed Name)

(Company Name)

(Mailing Address)

(City, State, Zip Code)

SURETY:

By: _____
(Signature of Attorney-in-Fact)

Date Issued: _____

(Printed Name)

(Company Name)

(Mailing Address)

(City, State, Zip Code)

(Affix SURETY'S SEAL)

NOTE: If CONTRACTOR is Partnership, all Partners must execute bond.

END OF SECTION

SECTION 00620 - PAYMENT BOND

KNOW ALL PERSONS BY THESE PRESENTS: That we _____
(Name of Contractor)

_____ a _____
(Corporation, Partnership, Individual)

hereinafter called "Principal" and _____
(Surety)

of _____, State of _____ hereinafter called the "Surety," are held and
firmly bound to the CITY AND BOROUGH of JUNEAU, ALASKA hereinafter called "OWNER,"
(Owner) (City and State)

for the penal sum of _____

_____ dollars (\$ _____) in lawful money of the
United States, for the payment of which sum well and truly to be made, we bind ourselves, our heirs, executors,
administrators and successors, jointly and severally, firmly by these presents.

THE CONDITION OF THIS OBLIGATION is such that whereas, the CONTRACTOR has entered
into a certain contract with the OWNER, the effective date of which is (CBJ Contracts Office to fill in effective
date) _____, a copy of which is hereto attached and made a part hereof for the
construction of:

**University Drive Lighting Upgrades
CBJ Contract No. BE21-092**

NOW, THEREFORE, if the Principal shall promptly make payment to all persons, firms,
Subcontractors, and corporations furnishing materials for, or performing labor in the prosecution of the WORK
provided for in such contract, and any authorized extension or modification thereof, including all amounts due
for materials, lubricants, oil, gasoline, coal and coke, repairs on machinery, equipment and tools, consumed or
used in connection with the construction of such WORK, and all insurance premiums on said work, and for all
labor performed in such WORK, whether by Subcontractor or otherwise, then this obligation shall be void;
otherwise to remain in full force and effect.

PROVIDED, FURTHER, that the said Surety, for value received hereby stipulates and agrees that no
change, extension of time, alteration or addition to the terms of the contract or to the work to be performed
thereunder or the specifications accompanying the same shall in any wise affect its obligation on this bond, and
it does hereby waive notice of any such change, extension of time, alteration or addition to the terms of the
contract or to the WORK or to the Specifications.

PROVIDED, FURTHER, that no final settlement between the OWNER and the Principal shall abridge
the right of any beneficiary hereunder, whose claim may be unsatisfied.

SECTION 00620 - PAYMENT BOND

**University Drive Lighting Upgrades
CBJ Contract No. BE21-092**

IN WITNESS WHEREOF, this instrument is issued in two (2) identical counterparts, each one of which shall be deemed an original.

CONTRACTOR:

By: _____
(Signature)

(Printed Name)

(Company Name)

(Mailing Address)

(City, State, Zip Code)

SURETY:

By: _____
(Signature of Attorney-in-Fact)

Date Issued: _____

(Printed Name)

(Company Name)

(Mailing Address)

(City, State, Zip Code)

(Affix SURETY'S SEAL)

NOTE: If CONTRACTOR is Partnership, all Partners must execute bond.

END OF SECTION

SECTION 00700 - GENERAL CONDITIONS

TABLE OF CONTENTS
(Revised 03-2003)

ARTICLE 1 DEFINITIONS 00700-5

ARTICLE 2 PRELIMINARY MATTERS

2.1 Delivery of Bonds/Insurance Certificates 00700-9
2.2 Copies of Documents 00700-9
2.3 Commencement of Contract Time; Notice to Proceed 00700-9
2.4 Starting the WORK 00700-9
2.5 Pre-construction Conference 00700-9
2.6 Finalizing CONTRACTOR Submittals..... 00700-9

ARTICLE 3 CONTRACT DOCUMENTS: INTENT, AMENDING, REUSE

3.1 Intent 00700-10
3.2 Order of Precedence of Contract Documents 00700-10
3.3 Amending and Supplementing Contract Documents..... 00700-11
3.4 Reuse of Documents..... 00700-11

ARTICLE 4 AVAILABILITY OF LANDS; PHYSICAL CONDITIONS; REFERENCE POINTS

4.1 Availability of Lands 00700-11
4.2 Physical Conditions - Subsurface and Existing Structures 00700-11
4.3 Differing Site Conditions 00700-12
4.4 Physical Conditions - Underground Utilities 00700-12
4.5 Reference Points..... 00700-13
4.6 Use of the CBJ/State Lemon Creek Gravel Pit 00700-13

ARTICLE 5 BONDS AND INSURANCE

5.1 Performance, Payment and Other Bonds 00700-14
5.2 Insurance 00700-15

ARTICLE 6 CONTRACTOR'S RESPONSIBILITIES

6.1 Supervision and Superintendence..... 00700-17
6.2 Labor, Materials, and Equipment 00700-17
6.3 Adjusting Progress Schedule..... 00700-18
6.4 Substitutes or "Or Equal" Items..... 00700-19
6.5 Concerning Subcontractors, Suppliers and Others 00700-19
6.6 Permits..... 00700-19
6.7 Patent Fees and Royalties 00700-20
6.8 Laws and Regulations..... 00700-20

SECTION 00700 - GENERAL CONDITIONS

ARTICLE 6 CONTRACTOR'S RESPONSIBILITIES (Cont'd.)

6.9 Taxes 00700-20
6.10 Use of Premises 00700-20
6.11 Safety and Protection..... 00700-21
6.12 Shop Drawings and Samples 00700-22
6.13 Continuing the WORK..... 00700-22
6.14 Indemnification 00700-22
6.15 Contractor's Daily Reports..... 00700-23
6.16 Assignment of Contract..... 00700-23
6.17 Contractor's Responsibility for Utility Property and Services 00700-23
6.18 Operating Water System Valves 00700-24
6.19 CONTRACTOR's WORK Schedule Limitations 00700-24

ARTICLE 7 OTHER WORK

7.1 Related WORK at Site 00700-24
7.2 Coordination..... 00700-25

ARTICLE 8 OWNER'S RESPONSIBILITIES

8.1 Communications..... 00700-25
8.2 Payments 00700-25
8.3 Lands, Easements, and Surveys..... 00700-25
8.4 Change Orders..... 00700-25
8.5 Inspections and Tests..... 00700-25
8.6 Suspension of WORK 00700-25
8.7 Termination of Agreement 00700-25

ARTICLE 9 ENGINEER'S STATUS DURING CONSTRUCTION

9.1 OWNER 's Representative 00700-25
9.2 Visits to Site 00700-25
9.3 Project Representation..... 00700-26
9.4 Clarifications and Interpretations..... 00700-28
9.5 Authorized Variations in WORK 00700-28
9.6 Rejecting Defective WORK 00700-28
9.7 CONTRACTOR Submittals, Change Orders, and Payments 00700-28
9.8 Decisions on Disputes 00700-28
9.9 Limitation on Engineer's Responsibilities 00700-29

SECTION 00700 - GENERAL CONDITIONS

ARTICLE 10 CHANGES IN THE WORK

10.1 General 00700-30
10.2 Allowable Quantity Variations 00700-30

ARTICLE 11 CHANGE OF CONTRACT PRICE

11.1 General 00700-31
11.2 Costs Relating to Weather 00700-31
11.3 Cost of WORK (Based on Time and Materials)..... 00700-32
11.4 CONTRACTOR's Fee..... 00700-34
11.5 Excluded Costs..... 00700-35

ARTICLE 12 CHANGE OF CONTRACT TIME

12.1 General 00700-36
12.2 Extensions of Time for Delay Due to Weather..... 00700-36

**ARTICLE 13 WARRANTY AND GUARANTEE; TESTS AND INSPECTIONS;
CORRECTION, REMOVAL, OR ACCEPTANCE OF DEFECTIVE WORK**

13.1 Warranty and Guarantee..... 00700-37
13.2 Access to WORK 00700-37
13.3 Tests and Inspections..... 00700-37
13.4 OWNER May Stop the WORK..... 00700-38
13.5 Correction or Removal of Defective WORK..... 00700-38
13.6 One Year Correction Period 00700-39
13.7 Acceptance of Defective WORK..... 00700-39

ARTICLE 14 PAYMENTS TO CONTRACTOR AND COMPLETION

14.1 Schedule of Values (Lump Sum Price Breakdown) 00700-39
14.2 Unit Price Bid Schedule 00700-39
14.3 Application for Progress Payment 00700-39
14.4 CONTRACTOR's Warranty of Title 00700-40
14.5 Review of Applications for Progress Payment 00700-40
14.6 Partial Utilization 00700-41
14.7 Substantial Completion 00700-41
14.8 Final Application for Payment..... 00700-41
14.9 Final Payment and Acceptance..... 00700-42
14.10 Release of Retainage and Other Deductions..... 00700-42
14.11 CONTRACTOR's Continuing Obligation..... 00700-42
14.12 Final Payment Terminates Liability of OWNER 00700-43

SECTION 00700 - GENERAL CONDITIONS

ARTICLE 15 SUSPENSION OF WORK AND TERMINATION

15.1 Suspension of WORK by OWNER..... 00700-43
15.2 Termination of Agreement by OWNER (CONTRACTOR Default)..... 00700-43
15.3 Termination of Agreement by OWNER (For Convenience) 00700-43
15.4 Termination of Agreement by CONTRACTOR..... 00700-44

ARTICLE 16 MISCELLANEOUS

16.1 Giving Notice 00700-44
16.2 Rights In and Use of Materials Found on the WORK 00700-44
16.3 Right to Audit..... 00700-45
16.4 Archaeological or Historical Discoveries 00700-45
16.5 Construction Over or Adjacent to Navigable Waters 00700-45
16.6 Gratuity and Conflict of Interest..... 00700-45
16.7 Suits of Law Concerning the WORK 00700-46
16.8 Certified Payrolls..... 00700-46
16.9 Prevailing Wage Rates 00700-46
16.10 Employment Reference 00700-47
16.11 Cost Reduction Incentive 00700-47

SECTION 00700 - GENERAL CONDITIONS

ARTICLE 1 DEFINITIONS

Wherever used in these General Conditions or in the Contract Documents the following terms have the meanings indicated which are applicable to both the singular and plural thereof. Where an entire word is capitalized in the definitions and is found not capitalized in the Contract Documents it has the ordinary dictionary definition.

Addenda - Written or graphic instruments issued prior to the opening of Bids which make additions, deletions, or revisions to the Contract Documents.

Agreement - The written contract between the OWNER and the CONTRACTOR covering the WORK to be performed; other documents are attached to the Agreement and made a part thereof as provided therein.

Application for Payment - The form furnished by the ENGINEER which is to be used by the CONTRACTOR to request progress or final payment and which is to be accompanied by such supporting documentation as is required by the Contract Documents.

Asbestos - Any material that contains more than one percent asbestos and is friable or is releasing asbestos fibers into the air above current action levels established by the United States Occupational Safety and Health Administration.

Bid - The offer or proposal of the Bidder submitted on the prescribed form setting forth the price or prices for the WORK.

Bonds - Bid, Performance, and Payment Bonds and other instruments which protect against loss due to inability or refusal of the CONTRACTOR to perform its contract.

CBJ Project Manager - The authorized representative of the City and Borough of Juneau Engineering Department, as OWNER, who is responsible for administration of the contract.

Change Order - A document recommended by the ENGINEER, which is signed by the CONTRACTOR and the OWNER and authorizes an addition, deletion, or revision in the WORK, or an adjustment in the Contract Price or the Contract Time, issued on or after the Effective Date of the Agreement.

Contract Documents - The Table of Contents, Notice Inviting Bids, Instructions to Bidders, Bid Forms (including the Bid, Bid Schedule(s), Information Required of Bidder, Bid Bond, and all required certificates and affidavits), Agreement, Performance Bond, Payment Bond, General Conditions, Supplementary General Conditions, Technical Specifications, Drawings, Permits, and all Addenda, and Change Orders executed pursuant to the provisions of the Contract Documents.

Contract Price - The total monies payable by the OWNER to the CONTRACTOR under the terms and conditions of the Contract Documents.

Contract Time - The number of successive calendar Days stated in the Contract Documents for the completion of the WORK.

CONTRACTOR - The individual, partnership, corporation, joint-venture or other legal entity with whom the OWNER has executed the Agreement.

SECTION 00700 - GENERAL CONDITIONS

Day - A calendar day of 24 hours measured from midnight to the next midnight.

Defective WORK - WORK that is unsatisfactory, faulty, or deficient; or that does not conform to the Contract Documents; or that does not meet the requirements of any inspection, reference standard, test, or approval referred to in the Contract Documents; or WORK that has been damaged prior to the ENGINEER's recommendation of final payment.

Drawings - The Drawings, plans, maps, profiles, diagrams, and other graphic representations which indicate the character, location, nature, extent, and scope of the WORK and which have been prepared by the ENGINEER and are referred to in the Contract Documents. Shop Drawings are not within the meaning of this paragraph.

Effective Date of the Agreement - The date indicated in the Agreement on which it becomes effective, but if no such date is indicated it means the date on which the Agreement is signed and delivered by the last of the two parties to sign and deliver.

Engineer of Record - The individual, partnership, corporation, joint-venture or other legal entity named as such in the Contract Documents.

ENGINEER - The ENGINEER is the firm or person(s) selected by the City and Borough of Juneau (CBJ) to perform the duties of project inspection and management. CBJ will inform the CONTRACTOR of the identity of the ENGINEER at or before the Notice to Proceed.

Field Order - A written order issued by the ENGINEER which may or may not involve a change in the WORK.

General Requirements - Division 1 of the Technical Specifications.

Hazardous Waste - The term Hazardous Waste shall have the meaning provided in Section 1004 of the Solid Waste Disposal Act (42 USC Section 9603) as amended from time to time.

Holidays - The CBJ legal holidays occur on:

1. New Year's Day - January 1
2. Martin Luther King's Birthday - Third Monday in January
3. President's Day - Third Monday in February
4. Seward's Day - Last Monday in March
5. Memorial Day - Last Monday in May
6. Independence Day - July 4
7. Labor Day - First Monday in September
8. Alaska Day - October 18
9. Veteran's Day - November 11
10. Thanksgiving Day - Fourth Thursday and the following Friday in November
11. Christmas Day - December 25

If any holiday listed above falls on a Saturday, Saturday and the preceding Friday are both legal holidays. If the holiday should fall on a Sunday, Sunday and the following Monday are both legal holidays.

SECTION 00700 - GENERAL CONDITIONS

Inspector - The authorized representative of the ENGINEER assigned to make detailed inspections for conformance to the Contract Documents. Any reference to the Resident Project Representative in this document shall mean the Inspector.

Laws and Regulations; Laws or Regulations - Any and all applicable laws, rules, regulations, ordinances, codes, and/or orders of any and all governmental bodies, agencies, authorities and courts having jurisdiction.

Mechanic's Lien - A form of security, an interest in real property, which is held to secure the payment of an obligation. When referred to in these Contract Documents, "Mechanic's Lien" or "lien" means "Stop Notice".

Milestone - A principal event specified in the Contract Documents relating to an intermediate completion date of a portion of the WORK, or a period of time within which the portion of the WORK should be performed prior to Substantial Completion of all the WORK.

Notice of Award - The written notice by the OWNER to the apparent successful bidder stating that the apparent successful bidder has complied with all conditions for award of the contract.

Notice of Completion - A form signed by the ENGINEER and the CONTRACTOR recommending to the OWNER that the WORK is Substantially Complete and fixing the date of Substantial Completion. After acceptance of the WORK by the OWNER's governing body, the form is signed by the OWNER and filed with the County Recorder. This filing starts the 30-day lien filing period on the WORK.

Notice to Proceed - The written notice issued by the OWNER to the CONTRACTOR authorizing the CONTRACTOR to proceed with the WORK and establishing the date of commencement of the Contract Time.

Notice of Intent to Award - The written notice by the OWNER to the apparent successful bidder stating that upon compliance by the apparent successful bidder with the requirements listed therein, within the time specified, the OWNER will enter into an Agreement.

OWNER - The City and Borough of Juneau (CBJ), acting through its legally designated officials, officers, or employees.

Partial Utilization - Use by the OWNER or a substantially completed part of the WORK for the purpose for which it is intended prior to Substantial Completion of all the WORK.

PCB's - Polychlorinated biphenyls.

PERMITTEE – See definition for CONTRACTOR.

Petroleum - Petroleum, including crude oil or any fraction thereof which is liquid at standard conditions of temperature and pressure (60 degrees Fahrenheit and 14.7 pounds per square inch absolute), such as oil, petroleum, fuel oil, oil sludge, oil refuse, gasoline, kerosene, and oil mixed with other non-Hazardous Wastes and crude oils.

Project - The total construction of which the WORK to be provided under the Contract Documents may be the whole, or a part as indicated elsewhere in the Contract Documents.

SECTION 00700 - GENERAL CONDITIONS

Radioactive Material - Source, special nuclear, or byproduct material as defined by the Atomic Energy Act of 1954 (42 USC Section 2011 et seq.) as amended from time to time.

Shop Drawings - All Drawings, diagrams, illustrations, schedules and other data which are specifically prepared by or for the CONTRACTOR and submitted by the CONTRACTOR, to the ENGINEER, to illustrate some portion of WORK.

Specifications - Same definition as "Technical Specifications" hereinafter.

Stop Notice - A legal remedy for Subcontractors and suppliers who contribute to public works, but who are not paid for their WORK, which secures payment from construction funds possessed by the OWNER. For public property, the Stop Notice remedy is designed to substitute for mechanic's lien rights.

Sub-Consultant - The individual, partnership, corporation, joint-venture or other legal entity having a direct contract with ENGINEER, or with any of its Consultants to furnish services with respect to the Project.

Subcontractor - An individual, partnership, corporation, joint-venture or other legal entity having a direct contract with the CONTRACTOR, or with any of its Subcontractors, for the performance of a part of the WORK at the site.

Substantial Completion - Refers to when the WORK has progressed to the point where, in the opinion of the ENGINEER as evidenced by Notice of Completion as applicable, it is sufficiently complete, in accordance with the Contract Documents, so that the WORK can be utilized for the purposes for which it is intended; or if no such notice is issued, when final payment is due in accordance with Paragraph 14.8. The terms "substantially complete" and "substantially completed" as applied to any WORK refer to substantial completion thereof.

Supplementary General Conditions (SGC) - The part of the Contract Documents which make additions, deletions, or revisions to these General Conditions.

Supplier - A manufacturer, fabricator, supplier, distributor, materialman, or vendor.

Technical Specifications - Divisions 1 through 16 of the Contract Documents consisting of the General Requirements and written technical descriptions of products and execution of the WORK.

Underground Utilities - All pipelines, conduits, ducts, cables, wires, manholes, vaults, tanks, tunnels, or other such facilities or attachments, and any encasements containing such facilities which have been installed underground to furnish any of the following services or materials: water, sewage and drainage removal, electricity, gases, steam, liquid petroleum products, telephone or other communications, cable television, traffic, or other control systems.

WORK, Work - The entire completed construction or the various separately identifiable parts thereof required to be furnished under the Contract Documents. WORK is the result of performing, or furnishing labor and furnishing and incorporating materials and equipment into the construction, and performing or furnishing services and furnishing documents, all as required by the Contract Documents.

SECTION 00700 - GENERAL CONDITIONS

ARTICLE 2 PRELIMINARY MATTERS

- 2.1 DELIVERY OF BONDS/INSURANCE CERTIFICATES. When the CONTRACTOR delivers the signed Agreements to the OWNER, the CONTRACTOR shall also deliver to the OWNER such Bonds and Insurance Policies and Certificates as the CONTRACTOR may be required to furnish in accordance with the Contract Documents.
- 2.2 COPIES OF DOCUMENTS. The OWNER shall furnish to the CONTRACTOR the required number of copies of the Contract Documents specified in the Supplementary General Conditions.
- 2.3 COMMENCEMENT OF CONTRACT TIME; NOTICE TO PROCEED. The Contract Time will start to run on the commencement date stated in the Notice to Proceed.
- 2.4 STARTING THE WORK
- A. The CONTRACTOR shall begin to perform the WORK within 10 days after the commencement date stated in the Notice to Proceed, but no WORK shall be done at the site prior to said commencement date.
 - B. Before undertaking each part of the WORK, the CONTRACTOR shall carefully study and compare the Contract Documents and check and verify pertinent figures shown thereon and all applicable field measurements. The CONTRACTOR shall promptly report in writing to the ENGINEER any conflict, error, or discrepancy which the CONTRACTOR may discover and shall obtain a written interpretation or clarification from the ENGINEER before proceeding with any WORK affected thereby.
 - C. The CONTRACTOR shall submit to the ENGINEER for review those documents called for under Section 01300 - CONTRACTOR Submittals in the General Requirements.
- 2.5 PRE-CONSTRUCTION CONFERENCE. The CONTRACTOR is required to attend a Pre-Construction Conference. This conference will be attended by the ENGINEER and others as appropriate in order to discuss the WORK in accordance with the applicable procedures specified in the General Requirements, Section 01010 - Summary of WORK in the General Requirements.
- 2.6 FINALIZING CONTRACTOR SUBMITTALS. At least 7 days before submittal of the first Application for Payment a conference attended by the CONTRACTOR, the ENGINEER and others as appropriate will be held to finalize the initial CONTRACTOR submittals in accordance with the General Requirements. As a minimum the CONTRACTOR's representatives should include the project manager and schedule expert. The CONTRACTOR should plan on this meeting taking no less than 8 hours. If the submittals are not finalized at the end of the meeting, additional meetings will be held so that the submittals can be finalized prior to the submittal of the first application for payment. No application for payment will be processed until CONTRACTOR submittals are finalized.

SECTION 00700 - GENERAL CONDITIONS

ARTICLE 3 CONTRACT DOCUMENTS: INTENT, AMENDING, REUSE

3.1 INTENT

- A. The Contract Documents comprise the entire Agreement between the OWNER and the CONTRACTOR concerning the WORK. The Contract Documents shall be construed as a whole in accordance with Alaska Law.
- B. It is the intent of the Contract Documents to describe the WORK, functionally complete, to be constructed in accordance with the Contract Documents. Any work, materials, or equipment that may reasonably be inferred from the Contract Documents as being required to produce the intended result shall be supplied whether or not specifically called for. When words or phrases which have a well-known technical or construction industry or trade meaning are used to describe work, materials, or equipment such words or phrases shall be interpreted in accordance with that meaning, unless a definition has been provided in Article 1 of the General Conditions. Reference to standard specifications, manuals, or codes of any technical society, organization, or association, or to the Laws or Regulations of any governmental authority, whether such reference be specific or by implication, shall mean the latest standard specification, manual, code, or Laws or Regulations in effect at the time of opening of Bids, except as may be otherwise specifically stated. However, no provision of any referenced standard specification, manual, or code (whether or not specifically incorporated by reference in the Contract Documents) shall be effective to change the duties and responsibilities of the OWNER, the CONTRACTOR, or the ENGINEER or any of their consultants, agents, or employees from those set forth in the Contract Documents.
- C. If, during the performance of the WORK, CONTRACTOR discovers any conflict, error, ambiguity or discrepancy within the Contract Documents or between the Contract Documents and any provision of any such Law or Regulation applicable to the performance of the WORK or of any such standard, specification, manual or code or of any instruction of any Supplier referred to in paragraph 6.5, the CONTRACTOR shall report it to the ENGINEER in writing at once, and the CONTRACTOR shall not proceed with the WORK affected thereby (except in an emergency as authorized by the ENGINEER) until a clarification field order, or Change Order to the Contract Documents has been issued.

3.2 ORDER OF PRECEDENCE OF CONTRACT DOCUMENTS

- A. In resolving conflicts resulting from, errors, or discrepancies in any of the Contract Documents, the order of precedence shall be as follows:
 - 1. Permits from other agencies as may be required by law, excepting the definition of "PERMITEE" in these permits.
 - 2. Field Orders
 - 3. Change Orders
 - 4. ENGINEER's written interpretations and clarifications.
 - 5. Agreement
 - 6. Addenda
 - 7. CONTRACTOR's Bid (Bid Form)
 - 8. Supplementary General Conditions
 - 9. Notice Inviting Bids

SECTION 00700 - GENERAL CONDITIONS

10. Instructions to Bidders
11. General Conditions
12. Technical Specifications
13. Drawings

B. With reference to the Drawings the order of precedence is as follows:

1. Figures govern over scaled dimensions
2. Detail Drawings govern over general Drawings
3. Addenda/ Change Order drawings govern over Contract Drawings
4. Contract Drawings govern over standard drawings

3.3 AMENDING AND SUPPLEMENTING CONTRACT DOCUMENTS. The Contract Documents may be amended to provide for additions, deletions, and revisions in the WORK or to modify the terms and conditions thereof by a Change Order (pursuant to Article 10 CHANGES IN THE WORK).

3.4 REUSE OF DOCUMENTS. Neither the CONTRACTOR, nor any Subcontractor or Supplier, nor any other person or organization performing any of the WORK under a contract with the OWNER shall have or acquire any title to or ownership rights in any of the Drawings, Technical Specifications, or other documents used on the WORK, and they shall not reuse any of them on the extensions of the Project or any other project without written consent of the OWNER.

ARTICLE 4 AVAILABILITY OF LANDS; PHYSICAL CONDITIONS; REFERENCE POINTS

4.1 AVAILABILITY OF LANDS. The OWNER shall furnish, as indicated in the Contract Documents, the lands upon which the WORK is to be performed, rights-of-way and easements for access thereto, and such other lands which are designated for the use of the CONTRACTOR. Easements for permanent structures or permanent changes in existing facilities will be obtained and paid for by the OWNER, unless otherwise provided in the Contract Documents. Nothing contained in the Contract Documents shall be interpreted as giving the CONTRACTOR exclusive occupancy of the lands or rights-of-way provided. The CONTRACTOR shall provide for all additional lands and access thereto that may be required for temporary construction facilities or storage of materials and equipment; provided, that the CONTRACTOR shall not enter upon nor use any property not under the control of the OWNER until a written temporary construction easement, lease or other appropriate agreement has been executed by the CONTRACTOR and the property owner, and a copy of said agreement furnished to the ENGINEER prior to said use; and, neither the OWNER nor the ENGINEER shall be liable for any claims or damages resulting from the CONTRACTOR's unauthorized trespass or use of any such properties.

4.2 PHYSICAL CONDITIONS - SUBSURFACE AND EXISTING STRUCTURES

A. Explorations and Reports. Reference is made to SGC 4.2 Physical Conditions of the Supplementary General Conditions for identification of those reports of explorations and tests of sub-surface conditions at the site that have been utilized by the ENGINEER in the preparation of the Contract Documents. The CONTRACTOR may rely upon the accuracy of the technical data contained in such reports, however, reports are not to be considered complete or comprehensive and nontechnical data, interpretations, and opinions contained in such reports are not to be relied on by the CONTRACTOR. The CONTRACTOR is

SECTION 00700 - GENERAL CONDITIONS

responsible for any further explorations or tests that may be necessary and any interpretation, interpolation, or extrapolation that it makes of any information shown in such reports.

- B. Existing Structures. Reference is made to SGC 4.2 Physical Conditions of the Supplementary General Conditions for identification of those drawings of physical conditions in or relating to existing surface and subsurface structures (except Underground Utilities referred to in Paragraph 4.4 herein) which are at or contiguous to the site that have been utilized by the ENGINEER in the preparation of the Contract Documents. The CONTRACTOR may rely upon the accuracy of the technical data contained in such drawings, however, nontechnical data, interpretations, and opinions contained in such drawings are not to be relied on by the CONTRACTOR. The CONTRACTOR is also responsible for any interpretation, interpolation, or extrapolation that it makes of any information shown in such drawings.

4.3 DIFFERING SITE CONDITIONS

- A. The CONTRACTOR shall promptly upon discovery (but in no event later than 14 days thereafter) and before the following conditions are disturbed, notify the ENGINEER, in writing of any:
 - 1. Material that the CONTRACTOR believes may be material that is hazardous waste, as defined in Article 1 of these General Conditions, or asbestos, PCB's, petroleum or any other substance or material posing a threat to human or to the environment.
 - 2. Subsurface or latent physical conditions at the site differing from those indicated.
 - 3. Unknown physical conditions at the site of any unusual nature, different materially from those ordinarily encountered and generally recognized as inherent in WORK of the character provided for in the contract.
- B. The OWNER shall promptly investigate the conditions, and if it finds that the conditions do materially so differ, or do involve hazardous waste, and cause a decrease or increase in the CONTRACTOR's cost of, or the time required for, performance of any part of the WORK shall issue a Change Order under the procedures described in the contract.
- C. In the event that a dispute arises between the OWNER and the CONTRACTOR whether the conditions materially differ, or involved hazardous waste or other materials listed above, or cause a decrease or increase in the CONTRACTOR's cost of, or time required for, performance of any part of the WORK, the CONTRACTOR shall not be excused from any scheduled completion date provided for by the contract, but shall proceed with all WORK to be performed under the contract. The CONTRACTOR shall retain any and all rights provided either by contract or by Law which pertain to the resolution of disputes and protests between the contracting parties.

4.4 PHYSICAL CONDITIONS - UNDERGROUND UTILITIES

- A. Indicated. The information and data indicated in the Contract Documents with respect to existing Underground Utilities at or contiguous to the site are based on information and data furnished to the OWNER or the ENGINEER by the owners of such Underground Utilities or by others. Unless it is expressly provided in the Supplementary General Conditions and/or Section 01530 - Protection and Restoration of Existing Facilities of the General Requirements, the OWNER and the ENGINEER shall not be responsible for the accuracy or

SECTION 00700 - GENERAL CONDITIONS

completeness of any such information or data, and the CONTRACTOR shall have full responsibility for reviewing and checking all such information and data, for locating all Underground Utilities indicated in the Contract Documents, for coordination of the WORK with the owners of such Underground Utilities during construction, for the safety and protection thereof and repairing any damage thereto resulting from the WORK, the cost of which will be considered as having been included in the Contract Price.

- B. Not Indicated. If an Underground Utility is uncovered or revealed at or contiguous to the site which was not indicated in the Contract Documents and which the CONTRACTOR could not reasonably have been expected to be aware of, the CONTRACTOR shall identify the owner of such Underground Utility and give written notice thereof to that owner and shall notify the ENGINEER in accordance with the requirements of the Supplementary General Conditions and Section 01530 - Protection and Restoration of Existing Facilities of the General Requirements.

4.5 REFERENCE POINTS

- A. The ENGINEER will provide one bench mark, near or on the site of the WORK, and will provide two points near or on the site to establish a base line for use by the CONTRACTOR for alignment control. Unless otherwise specified in the General Requirements, the CONTRACTOR shall furnish all other lines, grades, and bench marks required for proper execution of the WORK.
- B. The CONTRACTOR shall preserve all bench marks, stakes, and other survey marks, and in case of their removal or destruction by its own employees or by its Subcontractor's employees, the CONTRACTOR shall be responsible for the accurate replacement of such reference points by personnel qualified under the Alaska Statute governing the licensing of Architects, Engineers, and Land Surveyors.

4.6 USE OF THE CBJ/STATE LEMON CREEK GRAVEL PIT

- A. On City and Borough of Juneau (CBJ) construction projects, the CBJ may make unclassified material available to CONTRACTORS, from the CBJ/State Lemon Creek gravel pit, at a rate less than charged other customers. CONTRACTORS are not required to use material from the CBJ/State pit and the CBJ makes no guarantee as to the quantity or quality of the available material. For this Project, contact Alec Venechuk, CBJ Material Source Manager, at (907) 586-0874 for the current material rates.
- B. CONTRACTORS proposing to use gravel from the CBJ/State pit are required to be in good standing for all amounts owed to the CBJ, for previous gravel operations, prior to submitting a mining plan for approval. CONTRACTORS using the pit must comply with Allowable Use Permit USE 2008-00061. Failure to meet these requirements, if so subject, shall be sufficient reason to deny use of the CBJ/State pit as a gravel source. To determine if your company is subject to these requirements, contact the CBJ Engineering Department, Gravel Pit Management, at (907) 586-0874.
- C. CONTRACTORS deciding to use material from the CBJ/State pit shall provide an Individual Mining Plan prepared by a professional engineer registered in the State of Alaska. The Individual Mining Plan must be reviewed and approved by the CBJ, prior to commencing

SECTION 00700 - GENERAL CONDITIONS

operations within the pit. CONTRACTORS shall also secure a Performance Bond to ensure compliance with contract provisions, including any Individual Mining Plan stipulations. The bond shall remain in full force and effect until a release is obtained from the CBJ.

- D. If CONTRACTOR operations for a project do not exceed 500 tons of material, the CONTRACTOR will not be required to provide an Individual Mining Plan prepared by an engineer. However, the CONTRACTOR must submit an Individual Mining Plan that is in compliance with Allowable Use Permit USE 2008-00061 for gravel extraction within the CBJ/State pit. The CONTRACTOR must contact the CBJ Engineering Department for conditions for the extraction.
- E. CONTRACTORS using the CBJ material may do primary dry separation (screening) of materials within the pit. Crushing and washing of material will not be allowed. CONTRACTORS shall account for placement of materials removed from the pit. The CBJ may require CONTRACTORS to cross-check weight tickets, submit to an audit, or participate in other measures required by the CBJ to ensure accountability. Unprocessed overburden removed from the pit will not be weighed. All other material mined will be weighed at the CBJ scale. CONTRACTORS will be responsible for loading and/or screening their own material. If asphalt pavement is removed as part of the WORK, CONTRACTORS shall dispose of the material at a to-be-specified location within the pit area, as directed by the CBJ Project Manager.
- F. The gravel pit overhead charge shall be paid to the CBJ by the CONTRACTOR within 60 days after removal of all materials from the pit and prior to requesting and/or receiving final payment. Upon completion of each excavation CONTRACTORS shall notify the CBJ, in writing, in sufficient time to perform a field-compliance examination prior to vacating the pit. Any significant deviation from the stipulations of the Individual Mining Plan identified during the field inspection shall be corrected by the CONTRACTOR prior to release of the bond. A signed release from CBJ will be required prior to releasing the CONTRACTOR's bond.
- G. If asphalt pavement is removed as part of this WORK, the CONTRACTOR shall dispose of the material at the location designated as the Asphalt Storage Facility, or as directed by the ENGINEER.
- H. The CBJ/State pit is a seasonal operation. The hours of operation are from 7:00 a.m. to 6:00 p.m., Monday through Friday, from April 1 through October 15 of the year. CONTRACTORS may obtain gravel on weekends, or during the off-season, by applying for a separate agreement with the City and Borough of Juneau Engineering Department. The CONTRACTOR will be responsible for any additional costs incurred during weekend or off-season operations at the gravel pit.
- I. All Contractors/Equipment Operators using the CBJ/State Pit shall be in compliance with Federal Mine Safety and Health Administration regulations for quarry and gravel operations.

ARTICLE 5 BONDS AND INSURANCE

5.1 PERFORMANCE, PAYMENT, AND OTHER BONDS

SECTION 00700 - GENERAL CONDITIONS

- A. The CONTRACTOR shall furnish, when required, Performance and Payment Bonds on forms provided by the CBJ for the penal sums of 100% of the amount of the Bid award. The surety on each bond may be any corporation or partnership authorized to do business in the State of Alaska as an insurer under AS 21.09. These bonds shall remain in effect for 12 months after the date of final payment and until all obligations and liens under this contract have been satisfied. The CONTRACTOR shall also furnish such other Bonds as are required by the Supplementary General Conditions. All Bonds shall be in the form prescribed by the Contract Documents except as provided otherwise by Laws or Regulations, and shall be executed by such sureties as are named in the current list of "Companies Holding Certificates of Authority as Acceptable Sureties on Federal Bonds and as Acceptable Reinsuring Companies" as published in Circular 570 (amended) by the Audit Staff, Bureau of Government Financial Operations, U.S. Treasury Department. All Bonds signed by an agent must be accompanied by a certified copy of such agent's authority to act.
- B. If the surety on any Bond furnished by the CONTRACTOR is declared bankrupt or becomes insolvent or its right to do business is terminated in any state where any part of the WORK is located, the CONTRACTOR shall within 7 days thereafter substitute another Bond and Surety, which must be acceptable to the OWNER.
- C. All Bonds required by the Contract Documents to be purchased and maintained by CONTRACTOR shall be obtained from surety companies that are duly licensed or authorized in the State of Alaska to issue Bonds for the limits so required. Such surety companies shall also meet such additional requirements and qualifications as may be provided in the Supplementary General Conditions. The City Engineer may, on behalf of the OWNER, notify the surety of any potential default or liability.

5.2 INSURANCE

- A. The CONTRACTOR shall purchase and maintain the insurance required under this paragraph. Such insurance shall include the specific coverages set out herein and be written for not less than the limits of liability and coverages provided in the Supplementary General Conditions, or required by law, whichever are greater. All insurance shall be maintained continuously during the life of the Agreement up to the date of Final Completion and at all times thereafter when the CONTRACTOR may be correcting, removing, or replacing Defective WORK in accordance with Paragraph 13.6, but the CONTRACTOR's liabilities under this Agreement shall not be deemed limited in any way to the insurance coverage required.
- B. All insurance required by the Contract Documents to be purchased and maintained by the CONTRACTOR shall be obtained from insurance companies that are duly licensed or authorized in the State of Alaska to issue insurance policies for the limits and coverages so required. Such insurance companies shall have a current Best's Rating of at least an "A" (Excellent) general policy holder's rating and a Class VII financial size category and shall also meet such additional requirements and qualifications as may be provided in the Supplementary General Conditions.
- C. The CONTRACTOR shall furnish the OWNER with certificates showing the type, amount, class of operations covered, effective dates and dates of expiration of policies. All of the policies of insurance so required to be purchased and maintained (or the certificates or other

SECTION 00700 - GENERAL CONDITIONS

evidence thereof) shall contain a provision or endorsement that the coverage afforded will not be cancelled, reduced in coverage, or renewal refused until at least 30 days' prior written notice has been given to the OWNER by certified mail. All such insurance required herein (except for Workers' Compensation and Employer's Liability) shall name the OWNER, its Consultants and subconsultants and their officers, directors, agents, and employees as "additional insureds" under the policies. The CONTRACTOR shall purchase and maintain the following insurance:

1. Workers' Compensation and Employer's Liability. This insurance shall protect the CONTRACTOR against all claims under applicable state workers' compensation laws. The CONTRACTOR shall also be protected against claims for injury, disease, or death of employees which, for any reason, may not fall within the provisions of a Workers' Compensation law. This policy shall include an "all states" endorsement. The CONTRACTOR shall require each Subcontractor similarly to provide Workers' Compensation Insurance for all of the latter's employees to be engaged in such WORK unless such employees are covered by the protection afforded by the CONTRACTOR's Workers' Compensation Insurance. In case any class of employees is not protected, under the Workers' Compensation Statute, the CONTRACTOR shall provide and shall cause each Subcontractor to provide adequate employer's liability insurance for the protection of such of its employees as are not otherwise protected.
2. Commercial General Liability. This insurance shall be written in comprehensive form and shall protect the CONTRACTOR against all claims arising from injuries to persons other than its employees or damage to property of the OWNER or others arising out of any act or omission of the CONTRACTOR or its agents, employees, or Subcontractors. The policy shall contain no exclusions for any operations within the scope of this contract.
3. Comprehensive Automobile Liability. This insurance shall be written in comprehensive form and shall protect the CONTRACTOR against all claims for injuries to members of the public and damage to property of others arising from the use of motor vehicles, and shall cover operation on or off the site of all motor vehicles licensed for highway use, whether they are owned, non-owned, or hired. Coverage for hired motor vehicles should include endorsement covering liability assumed under this Agreement.
4. Subcontractor's Commercial General Liability Insurance and Commercial Automobile Liability Insurance. The CONTRACTOR shall either require each of its Subcontractors to procure and to maintain Subcontractor's Commercial General Liability and Property Damage Insurance and Vehicle Liability Insurance of the type and in the amounts specified in the Supplementary General Conditions or insure the activities of its Subcontractors in the CONTRACTOR's own policy, in like amount.
5. Builder's Risk. This insurance shall be of the "all risks" type, shall be written in completed value form, and shall protect the CONTRACTOR, the OWNER, and the ENGINEER, against risks of damage to buildings, structures, and materials and equipment. The amount of such insurance shall be not less than the insurable value of the WORK at completion. Builder's risk insurance shall provide for losses to be payable to the CONTRACTOR and the OWNER, as their interests may appear. The policy shall contain a provision that in the event of payment for any loss under the coverage provided, the insurance company shall have no rights of recovery against the

SECTION 00700 - GENERAL CONDITIONS

CONTRACTOR, the OWNER, and the ENGINEER. The Builder's Risk policy shall insure against all risks of direct physical loss or damage to property from any external cause including flood and earthquake. Allowable exclusions, if any, shall be as specified in the Supplementary General Conditions.

ARTICLE 6 CONTRACTOR'S RESPONSIBILITIES

6.1 SUPERVISION AND SUPERINTENDENCE

- A. The CONTRACTOR shall supervise, inspect, and direct the WORK competently and efficiently, devoting such attention thereto and applying such skills and expertise as may be necessary to perform the WORK in accordance with the Contract Documents. The CONTRACTOR shall be solely responsible for the means, methods, techniques, sequences, and procedures of construction and safety precautions and programs incidental thereto. The CONTRACTOR shall be responsible to see that the completed WORK complies accurately with the Contract Documents.
- B. The CONTRACTOR shall designate in writing and keep on the WORK site at all times during its progress a technically qualified, English-speaking superintendent, who is an employee of the CONTRACTOR and who shall not be replaced without written notice to the OWNER and the ENGINEER. The superintendent will be the CONTRACTOR's representative at the site and shall have authority to act on behalf of the CONTRACTOR. All communications given to the superintendent shall be as binding as if given to the CONTRACTOR. The CONTRACTOR shall issue all its communications to the OWNER through the ENGINEER and the ENGINEER only.
- C. The CONTRACTOR's superintendent shall be present at the site of the WORK at all times while WORK is in progress. Failure to observe this requirement shall be considered suspension of the WORK by the CONTRACTOR until such time as such superintendent is again present at the site.

6.2 LABOR, MATERIALS, AND EQUIPMENT

- A. The CONTRACTOR shall provide competent, suitably qualified personnel to survey and lay out the WORK and perform construction as required by the Contract Documents. The CONTRACTOR shall furnish, erect, maintain, and remove the construction plant and any temporary works as may be required. The CONTRACTOR shall at all times maintain good discipline and order at the site. Except in connection with the safety or protection of persons or the WORK or property at the site or adjacent thereto, and except as otherwise indicated in the Contract Documents, all WORK at the site shall be performed during regular working hours, and the CONTRACTOR will not permit overtime work or the performance of work on Saturday, Sunday, or any legal holiday without the OWNER's written consent. The CONTRACTOR shall apply for this consent through the ENGINEER.
- B. Except as otherwise provided in this Paragraph, the CONTRACTOR shall receive no additional compensation for overtime work, i.e., work in excess of 8 hours in any one calendar day or 40 hours in any one calendar week, even though such overtime work may be required under emergency conditions and may be ordered by the ENGINEER in writing. Additional compensation will be paid the CONTRACTOR for overtime work only in the

SECTION 00700 - GENERAL CONDITIONS

event extra work is ordered by the ENGINEER and the Change Order specifically authorizes the use of overtime work and then only to such extent as overtime wages are regularly being paid by the CONTRACTOR for overtime work of a similar nature in the same locality.

- C. All costs of inspection and testing performed during overtime work by the CONTRACTOR which is allowed solely for the convenience of the CONTRACTOR shall be borne by the CONTRACTOR. The OWNER shall have the authority to deduct the cost of all such inspection and testing from any partial payments otherwise due to the CONTRACTOR.
 - D. Unless otherwise specified in the Contract Documents, the CONTRACTOR shall furnish and assume full responsibility for all materials, equipment, labor, transportation, construction equipment and machinery, tools, appliances, fuel, power, light, heat, telephone, water, sanitary facilities, and all other facilities and incidentals necessary for the furnishing, performance, testing, start-up, and completion of the WORK.
 - E. All materials and equipment to be incorporated into the WORK shall be of good quality and new, except as otherwise provided in the Contract Documents. All warranties and guarantees specifically called for by the Specifications shall expressly run to the benefit of the OWNER. If required by the ENGINEER, the CONTRACTOR shall furnish satisfactory evidence (including reports of required tests) as to the kind and quality of materials and equipment. All materials and equipment shall be applied, installed, connected, erected, used, cleaned, and conditioned in accordance with the instructions of the applicable Supplier except as otherwise provided in the Contract Documents; but no provisions of any such instructions will be effective to assign to the ENGINEER, or any of the ENGINEER consultants, agents, or employees, any duty or authority to supervise or direct the furnishing or performance of the WORK or any duty or authority to undertake responsibility contrary to the provisions of Paragraphs 9.9C and 9.9D.
 - F. The CONTRACTOR shall at all times employ sufficient labor and equipment for prosecuting the several classes of WORK to full completion in the manner and time set forth in and required by these specifications. All workers shall have sufficient skill and experience to perform properly the WORK assigned to them. Workers engaged in special WORK, or skilled WORK, shall have sufficient experience in such WORK and in the operation of the equipment required to perform all WORK, properly and satisfactorily.
 - G. Any person employed by the CONTRACTOR or by any Subcontractor who, in the opinion of the ENGINEER, does not perform the WORK in a proper and skillful manner, or is intemperate or disorderly shall, at the written request of the ENGINEER, be removed forthwith by the CONTRACTOR or Subcontractor employing such person, and shall not be employed again in any portion of the WORK without the approval of the ENGINEER. Should the CONTRACTOR fail to remove such person or persons as required above, or fail to furnish suitable and sufficient personnel for the proper prosecution of the WORK, the ENGINEER may suspend the WORK by written notice until such orders are complied with.
- 6.3 ADJUSTING PROGRESS SCHEDULE. The CONTRACTOR shall submit monthly updates of the progress schedule to the ENGINEER for acceptance in accordance with the provisions in Section 01300 - CONTRACTOR Submittals in the General Requirements.

SECTION 00700 - GENERAL CONDITIONS

- 6.4 SUBSTITUTES OR "OR-EQUAL" ITEMS. The CONTRACTOR shall submit proposed substitutes or "or-equal" items in accordance with the provisions in Section 01300 - CONTRACTOR Submittals in the General Requirements.
- 6.5 CONCERNING SUBCONTRACTORS, SUPPLIERS, AND OTHERS.
- A. The CONTRACTOR shall be responsible to the OWNER and the ENGINEER for the acts and omissions of its Subcontractors and their employees to the same extent as CONTRACTOR is responsible for the acts and omissions of its own employees. Nothing contained in this Paragraph shall create any contractual relationship between any Subcontractor and the OWNER or the ENGINEER nor relieve the CONTRACTOR of any liability or obligation under the prime contract.
- B. The CONTRACTOR shall perform not less than 40% of the WORK with its own forces (i.e., without subcontracting). The 40% requirement shall be understood to mean that the CONTRACTOR shall perform, with its own organization, WORK amounting to at least 40% of the awarded contract amount. The 40% requirement will be calculated based upon the total of the subcontract amounts submitted for contract award, and any other information requested by the OWNER from the apparent low bidder.
- 6.6 PERMITS
- A. Unless otherwise provided in the Supplementary General Conditions, the CONTRACTOR shall obtain and pay for all construction permits and licenses from the agencies having jurisdiction, including the furnishing of insurance and bonds if required by such agencies. The enforcement of such requirements under this contract shall not be made the basis for claims for additional compensation. The OWNER shall assist the CONTRACTOR, when necessary, in obtaining such permits and licenses. The CONTRACTOR shall pay all governmental charges and inspection fees necessary for the prosecution of the WORK, which are applicable at the time of opening of Bids. The CONTRACTOR shall pay all charges of utility owners for connections to the WORK.
- B. These Contract Documents may require that the WORK be performed within the conditions and/or requirements of local, state and/or federal permits. These permits may be bound within the Contract Documents, included within the Contract Documents by reference, or included as part of the WORK, as designated in this Section. The CONTRACTOR is responsible for completing the WORK required for compliance with all permit requirements; this WORK is incidental to other items in the Contract Documents. Any reference to the PERMITTEE in the permits shall mean the CONTRACTOR. If any permits were acquired by the OWNER, this action was done to expedite the start of construction. If the CONTRACTOR does not complete the WORK within the specified permit window, the CONTRACTOR shall be responsible for the permit extension, and for completing any additional requirements placed upon the permit.
- C. The OWNER shall apply for, and obtain, the necessary building permit for this Project, however, the CONTRACTOR is responsible for scheduling and coordinating all necessary inspections. The CBJ Inspection number is 586-1703. All other provisions of this Section remain in effect.

SECTION 00700 - GENERAL CONDITIONS

- 6.7 **PATENT FEES AND ROYALTIES.** The CONTRACTOR shall pay all license fees and royalties and assume all costs incident to the use in the performance of the WORK or the incorporation in the WORK of any invention, design, process, product, software or device which is the subject of patent rights or copyrights held by others. If a particular invention, design, process, product, or device is specified in the Contract Documents for use in the performance of the WORK and if to the actual knowledge of the OWNER or the ENGINEER its use is subject to patent rights or copyrights calling for the payment of any license fee or royalty to others, the existence of such rights shall be disclosed by the OWNER in the Contract Documents. The CONTRACTOR shall indemnify, defend and hold harmless the OWNER and the ENGINEER and anyone directly or indirectly employed by either of them from and against all claims, damages, losses, and expenses (including attorneys' fees and court costs) arising out of any infringement of patent rights or copyrights incident to the use in the performance of the WORK or resulting from the incorporation in the WORK of any invention, design, process, product, or device not specified in the Contract Documents, and shall defend all such claims in connection with any alleged infringement of such rights.
- 6.8 **LAWS AND REGULATIONS.** The CONTRACTOR shall observe and comply with all federal, state, and local laws, ordinances, codes, orders, and regulations which in any manner affect those engaged or employed on the WORK, the materials used in the WORK, or the conduct of the WORK. If any discrepancy or inconsistency should be discovered in this contract in relation to any such law, ordinance, code, order, or regulation, the CONTRACTOR shall report the same in writing to the ENGINEER. The CONTRACTOR shall indemnify, defend, and hold harmless the OWNER, the ENGINEER, and their officers, agents, and employees against all claims or liability arising from violation of any such law, ordinance, code, order, or regulation, whether by CONTRACTOR or by its employees, Subcontractors, or third parties. Any particular law or regulation specified or referred to elsewhere in the Contract Documents shall not in any way limit the obligation of the CONTRACTOR to comply with all other provisions of federal, state, and local laws and regulations. The OWNER may, per AS 36.30, audit the CONTRACTOR's or Subcontractor(s) records that are related to the cost or pricing data for this contract, all related Change Orders, and/or contract modifications.
- 6.9 **TAXES.** The CONTRACTOR shall pay all sales, consumer, use, and other similar taxes required to be paid by the CONTRACTOR in accordance with the Laws and Regulations of the place of the Project which are applicable during the performance of the WORK.
- 6.10 **USE OF PREMISES.** The CONTRACTOR shall confine construction equipment, the storage of materials and equipment, and the operations of workers to (1) the Project site, (2) the land and areas identified in and permitted by the Contract Documents, and (3) the other land and areas permitted by Laws and Regulations, rights-of-way, permits, leases and easements. The CONTRACTOR shall assume full responsibility for any damage to any such land or area, or to the owner or occupant thereof or of any land or areas contiguous thereto, resulting from the performance of the WORK. Should any claim be made against the OWNER or the ENGINEER by any such owner or occupant because of the performance of the WORK, the CONTRACTOR shall promptly attempt to settle with such other party by agreement or otherwise resolve the claim through litigation. The CONTRACTOR shall, to the fullest extent permitted by Laws and Regulations, indemnify, defend, and hold the OWNER and the ENGINEER harmless from and against all claims, damages, losses, and expenses (including, but not limited to, fees of engineers attorneys, and other professionals and court costs) arising directly, indirectly, or consequentially out of any action, legal or equitable, brought by any such owner or occupant against the OWNER, the ENGINEER, their Consultants, Sub-consultants, and the officers,

SECTION 00700 - GENERAL CONDITIONS

directors, employees and agents of each and any of them to the extent caused by or based upon the CONTRACTOR's performance of the WORK.

6.11 SAFETY AND PROTECTION

- A. The CONTRACTOR shall be responsible for initiating, maintaining, and supervising all safety precautions and programs in connection with the WORK. The CONTRACTOR shall take all necessary precautions for the safety of, and shall provide the necessary protection to prevent damage, injury or loss to:
1. all employees on the WORK and other persons and organizations who may be affected thereby;
 2. all the WORK and materials and equipment to be incorporated therein, whether in storage on or off the site; and
 3. other property at the site or adjacent thereto, including trees, shrubs, lawns, walks, pavements, roadways, structures, and utilities not designated for removal, relocation, or replacement in the course of construction.
- B. The CONTRACTOR shall comply with all applicable Laws and Regulations whether referred to herein or not) of any public body having jurisdiction for the safety of persons or property or to protect them from damage, injury, or loss and shall erect and maintain all necessary safeguards for such safety and protection. The CONTRACTOR shall notify owners of adjacent property and utilities when prosecution of the WORK may affect them, and shall cooperate with them in the protection, removal, relocation, and replacement of their property.
- C. The CONTRACTOR shall designate a qualified and experienced safety representative at the site whose duties and responsibilities shall be the prevention of accidents and the maintaining and supervising of safety precautions and program.
- D. Materials that contain hazardous substances or mixtures may be required on the WORK. A Material Safety Data Sheet shall be requested by the CONTRACTOR from the manufacturer of any hazardous product used.
- E. Material usage shall be accomplished with strict adherence to all safety requirements and all manufacturer's warnings and application instructions listed on the Material Safety Data Sheet and on the product container label.
- F. The CONTRACTOR shall be responsible for coordinating communications on any exchange of Material Safety Data Sheets or other hazardous material information that is required to be made available to, or exchanged between, or among, employers at the site in accordance with Laws or Regulations.
- G. The CONTRACTOR shall notify the ENGINEER if it considers a specified product or its intended usage to be unsafe. This notification must be given to the ENGINEER prior to the product being ordered, or if provided by some other party, prior to the product being incorporated in the WORK.

SECTION 00700 - GENERAL CONDITIONS

6.12 SHOP DRAWINGS AND SAMPLES

- A. After checking and verifying all field measurements and after complying with applicable procedures specified in the General Requirements, the CONTRACTOR shall submit to the ENGINEER for review, all Shop Drawings in accordance with Section 01300 - CONTRACTOR Submittals in the General Requirements.
- B. The CONTRACTOR shall also submit to the ENGINEER for review all samples in accordance with Section 01300 - CONTRACTOR Submittals in the General Requirements.
- C. Before submittal of each shop drawing or sample, the CONTRACTOR shall have determined and verified all quantities, dimensions, specified performance criteria, installation requirements, materials, catalog numbers, and similar data with respect thereto and reviewed or coordinated each Shop Drawing or sample with other Shop Drawings and samples and with the requirements of the WORK and the Contract Documents.

6.13 CONTINUING THE WORK. The CONTRACTOR shall carry on the WORK and adhere to the progress schedule during all disputes or disagreements with the OWNER. No work shall be delayed or postponed pending resolution of any disputes or disagreements, except as the CONTRACTOR and the OWNER may otherwise agree in writing.

6.14 INDEMNIFICATION

- A. To the fullest extent permitted by Laws and Regulations, the CONTRACTOR shall indemnify, defend, and hold harmless the OWNER, the ENGINEER, their Consultants, Sub-consultants and the officers, directors, employees, and agents of each and any of them, against and from all claims and liability arising under, by reason of or incidentally to the contract or any performance of the WORK, but not from the sole negligence or willful misconduct of the OWNER, and the ENGINEER. Such indemnification by the CONTRACTOR shall include but not be limited to the following:
 - 1. Liability or claims resulting directly or indirectly from the negligence or carelessness of the CONTRACTOR, its employees, or agents in the performance of the WORK, or in guarding or maintaining the same, or from any improper materials, implements, or appliances used in its construction, or by or on account of any act or omission of the CONTRACTOR, its employees, agents, or third parties;
 - 2. Liability or claims arising directly or indirectly from bodily injury, occupational sickness or disease, or death of the CONTRACTOR's or Subcontractor's own employees engaged in the WORK resulting in actions brought by or on behalf of such employees against the OWNER, and the ENGINEER;
 - 3. Liability or claims arising directly or indirectly from or based on the violation of any law, ordinance, regulation, order, or decree, whether by the CONTRACTOR, its employees, or agents;
 - 4. Liability or claims arising directly or indirectly from the use or manufacture by the CONTRACTOR, its employees, or agents in the performance of this contract of any copyrighted or non-copyrighted composition, secret process, patented or non-patented invention, computer software, article, or appliance, unless otherwise specifically stipulated in this contract.

SECTION 00700 - GENERAL CONDITIONS

5. Liability or claims arising directly or indirectly from the breach of any warranties, whether express or implied, made to the OWNER or any other parties by the CONTRACTOR, its employees, or agents;
 6. Liabilities or claims arising directly or indirectly from the willful or criminal misconduct of the CONTRACTOR, its employees, or agents; and,
 7. Liabilities or claims arising directly or indirectly from any breach of the obligations assumed herein by the CONTRACTOR.
- B. The CONTRACTOR shall reimburse the ENGINEER and the OWNER for all costs and expenses, (including but not limited to fees and charges of engineers, attorneys, and other professionals and court costs including all costs of appeals) incurred by said OWNER, and the ENGINEER in enforcing the provisions of this Paragraph 6.14.
- C. The indemnification obligation under this Paragraph 6.14 shall not be limited in any way by any limitation of the amount or type of damages, compensation, or benefits payable by or for the CONTRACTOR or any such Subcontractor or other person or organization under workers' compensation acts, disability benefit acts, or other employee benefit acts.
- 6.15 **CONTRACTOR'S DAILY REPORTS.** The CONTRACTOR shall complete a daily report indicating total manpower for each construction trade, major equipment on site, each Subcontractor's manpower, weather conditions, etc., involved in the performance of the WORK. The daily report shall be completed on forms provided by the ENGINEER and shall be submitted to the ENGINEER at the conclusion of each workday. The report should comment on the daily progress and status of the WORK within each major component of the WORK. These components will be decided by the ENGINEER. CONTRACTOR shall record the name, affiliation, time of arrival and departure, and reason for visit for all visitors to the location of the WORK.
- 6.16 **ASSIGNMENT OF CONTRACT.** The CONTRACTOR shall not assign, sublet, sell, transfer, or otherwise dispose of the contract or any portion thereof, or its right, title, or interest therein, or obligations thereunder, without the written consent of the OWNER except as imposed by law. If the CONTRACTOR violates this provision, the contract may be terminated at the option of the OWNER. In such event, the OWNER shall be relieved of all liability and obligations to the CONTRACTOR and to its assignee or transferee, growing out of such termination.
- 6.17 **CONTRACTOR'S RESPONSIBILITY FOR UTILITY PROPERTY AND SERVICES.** It is understood that any turn-on or turn-off, line locates and any other work or assistance necessary by the CBJ Water Utilities Division, will be at the CONTRACTOR's expense unless otherwise stated in the bid documents. All cost must be agreed to prior to any related actions, and will be considered incidental to the project cost. Billing to the CONTRACTOR will be direct from the CBJ Water Utilities Division.
- 6.18 **OPERATING WATER SYSTEM VALVES**
- A. The CONTRACTOR shall submit a written request, to the ENGINEER, for approval to operate any valve on any in-service section of the CBJ water system. The request must be submitted at least 24-hours prior to operating any valves. The CBJ Water Utilities Division reserves the right to approve or deny the request. The request shall specifically identify each valve to be operated, the time of operation, and the operation to be performed. The

SECTION 00700 - GENERAL CONDITIONS

CONTRACTOR shall obtain the written approval of the ENGINEER for any scheduled operation before operating any valve.

- B. The CONTRACTOR shall be responsible for all damages, both direct and consequential, to the City or any other party, caused by unauthorized operation of any valve of the CBJ water system.

6.19 CONTRACTOR'S WORK SCHEDULE LIMITATIONS. Construction of Buildings and Projects. It is unlawful to operate any pile driver, power shovel, pneumatic hammer, derrick, power hoist, or similar heavy construction equipment before 7:00 a.m. or after 10:00 p.m., Monday through Friday, or before 9:00 a.m. or after 10:00 p.m., Saturday and Sunday, unless a permit shall first be obtained from the City and Borough Building Official. Such permit shall be issued by the Building Official only upon a determination that such operation during hours not otherwise permitted hereunder is necessary and will not result in unreasonable disturbance to surrounding residents.

ARTICLE 7 OTHER WORK

7.1 RELATED WORK AT SITE

- A. The OWNER may perform other work related to the Project at the site by the OWNER's own forces, have other work performed by utility owners, or let other direct contracts therefor which may contain General Conditions similar to these. If the fact that such other work is to be performed was not noted in the Contract Documents, written notice thereof will be given to the CONTRACTOR prior to starting any such other work.
- B. The CONTRACTOR shall afford each other contractor who is a party to such a direct contract and each utility owner (or the OWNER, if the OWNER is performing the additional work with the OWNER's employees) proper and safe access to the site and a reasonable opportunity for the introduction and storage of materials and equipment and the execution of such work, and shall properly connect and coordinate the WORK with theirs. The CONTRACTOR shall do all cutting, fitting, and patching of the WORK that may be required to make its several parts come together properly and integrate with such other work. The CONTRACTOR shall not endanger any work of others by cutting, excavating, or otherwise altering their work and will only cut or alter their work with the written consent of the ENGINEER and the others whose work will be affected.
- C. If the proper execution or results of any part of the CONTRACTOR's work depends upon the work of any such other contractor or utility owner (or OWNER), the CONTRACTOR shall inspect and report to the ENGINEER in writing any delays, defects, or deficiencies in such other work that render it unavailable or unsuitable for such proper execution and results. The CONTRACTOR's failure to report such delays, defects, or deficiencies will constitute an acceptance of the other work as fit and proper for integration with the CONTRACTOR's work except for latent or nonapparent defects and deficiencies in the other work.

7.2 COORDINATION. If the OWNER contracts with others for the performance of other work on the Project at the site, the person or organization who will have authority and responsibility for coordination of the activities among the various prime contractors will be identified in the Supplementary General Conditions, and the specific matters to be covered by such authority and

SECTION 00700 - GENERAL CONDITIONS

responsibility will be itemized and the extent of such authority and responsibilities will be provided in the Supplementary General Conditions.

ARTICLE 8 OWNER'S RESPONSIBILITIES

8.1 COMMUNICATIONS

- A. The OWNER shall issue all its communications to the CONTRACTOR through the ENGINEER.
- B. The CONTRACTOR shall issue all its communications to the OWNER through the ENGINEER.

8.2 PAYMENTS. The OWNER shall make payments to the CONTRACTOR as provided in Paragraphs 14.5, 14.8, 14.9 and 14.10.

8.3 LANDS, EASEMENTS, AND SURVEYS. The OWNER's duties in respect of providing lands and easements and providing surveys to establish reference points are set forth in Paragraphs 4.1 and 4.5.

8.4 CHANGE ORDERS. The OWNER shall execute Change Orders as indicated in Paragraph 10.1F.

8.5 INSPECTIONS AND TESTS. The OWNER's responsibility in respect of inspections, tests, and approvals is set forth in Paragraph 13.3.

8.6 SUSPENSION OF WORK. In connection with the OWNER's right to stop WORK or suspend WORK, see Paragraphs 13.4 and 15.1.

8.7 TERMINATION OF AGREEMENT. Paragraphs 15.2 and 15.3 deal with the OWNER's right to terminate services of the CONTRACTOR.

ARTICLE 9 ENGINEER'S STATUS DURING CONSTRUCTION

9.1 OWNER'S REPRESENTATIVE. The ENGINEER will be the OWNER's representative during the construction period. The duties and responsibilities and the limitations of authority of the ENGINEER as the OWNER's representative during construction are set forth in the Contract Documents.

9.2 VISITS TO SITE. The ENGINEER will make visits to the site during construction to observe the progress and quality of the WORK and to determine, in general, if the WORK is proceeding in accordance with the Contract Documents. Exhaustive or continuous on-site inspections to check the quality or quantity of the WORK will not be required of the ENGINEER. The ENGINEER will not, during such visits, or as a result of such observations of the CONTRACTOR's WORK in progress, supervise, direct, or have control over the CONTRACTOR's WORK.

9.3 PROJECT REPRESENTATION. The ENGINEER may furnish an Inspector to assist in observing the performance of the WORK. The duties, responsibilities, and limitations of authority are as follows:

- A. Duties, Responsibilities and Limitations of Authority of Inspector

SECTION 00700 - GENERAL CONDITIONS

General. The Inspector, who is the ENGINEER's Agent, will act as directed by and under the supervision of the ENGINEER and will confer with the ENGINEER regarding its actions. The Inspector's dealings in matters pertaining to the on-site WORK shall, in general, be only with the ENGINEER and the CONTRACTOR, and dealings with Subcontractors shall only be through or with the full knowledge of the CONTRACTOR. Written communication with the OWNER will be only through or as directed by the ENGINEER.

Duties and Responsibilities. The Inspector may:

1. Review the progress schedule, list of Shop Drawing submittals and schedule of values prepared by the CONTRACTOR and consult with the ENGINEER concerning their acceptability.
2. Attend pre-construction conferences. Arrange a schedule of progress meetings and other job conferences as required in consultation with the ENGINEER and notify those expected to attend in advance. Attend meetings and maintain and circulate copies of minutes thereof.
3. Serve as the ENGINEER's liaison with the CONTRACTOR, working principally through the CONTRACTOR's superintendent and assist said superintendent in understanding the intent of the Contract Documents. Assist the ENGINEER in serving as the OWNER's liaison with the CONTRACTOR when the CONTRACTOR's operations affect the OWNER's on-site operations.
4. As requested by the ENGINEER, assist in obtaining from the OWNER additional details or information, when required at the site for proper execution of the WORK.
5. Receive and record date of receipt of Shop Drawings and samples, receive samples which are furnished at the site by the CONTRACTOR and notify the ENGINEER of their availability for examination.
6. Conduct on-site observations of the WORK in progress to assist the ENGINEER in determining if the WORK is proceeding in accordance with the Contract Documents.
7. Report to the ENGINEER whenever the Inspector believes that any WORK is unsatisfactory, faulty, or defective or does not conform to the Contract Documents, or does not meet the requirements of any inspection, tests or approval required to be made or has been damaged prior to final payment; and advise the ENGINEER when the Inspector believes WORK should be corrected or rejected or should be uncovered for observation, or requires special testing, inspection, or approval.
8. Verify that the tests, equipment, and systems startups and operating and maintenance instruction are conducted as required by the Contract Documents and in presence of the required personnel, and that the CONTRACTOR maintains adequate records thereof; observe, record and report to the ENGINEER appropriate details relative to the test procedures and start-ups.
9. Accompany visiting inspectors representing public or other agencies having jurisdiction over the WORK, record the outcome of these inspections, and report to the ENGINEER.
10. Transmit to the CONTRACTOR the ENGINEER's clarifications and interpretations of the Contract Documents.
11. Consider and evaluate the CONTRACTOR's suggestions for modifications in the Contract Documents and report them with recommendations to the ENGINEER.
12. Maintain at the job site orderly files for correspondence, reports of job conferences, Shop Drawings and sample submittals, reproductions of original Contract Documents including all addenda, Change Orders, field orders, additional Drawings issued

SECTION 00700 - GENERAL CONDITIONS

subsequent to the execution of the contract, the ENGINEER's clarifications and interpretations of the Contract Documents, progress reports, and other related documents.

13. Keep a diary or log book, recording hours on the job site, weather conditions, data relative to questions of extras or deductions, list all project visitors, daily activities, decisions, observations in general, and specific observations in more detail as in the case of performing and observing test procedures. Send copies to the ENGINEER.
14. Record names, addresses, and telephone numbers of the CONTRACTOR, Subcontractors, and major suppliers of materials and equipment.
15. Furnish the ENGINEER with periodic reports as required of progress of the WORK and the CONTRACTOR's compliance with the accepted progress schedule and schedule of CONTRACTOR submittals.
16. Consult with the ENGINEER in advance of scheduled major tests, inspections, or start of important phases of the WORK.
17. Report immediately to the ENGINEER upon the occurrence of any accident.
18. Review applications for payment with the CONTRACTOR for compliance with the established procedure for their submittal and forward them with recommendations to the ENGINEER, noting particularly their relation to the schedule of values, WORK completed, and materials and equipment delivered at the site but not incorporated in the WORK.
19. During the course of the WORK, verify that certificates, maintenance and operation manuals, and other data required to be assembled and furnished by the CONTRACTOR are applicable to the items actually installed; and deliver this material to the ENGINEER for its review and forwarding to the OWNER prior to final acceptance of the WORK.
20. Before the ENGINEER prepares a Certificate of Substantial Completion/Notice of Completion, as applicable, review the CONTRACTOR's punch list items requiring completion or correction and add any items that CONTRACTOR has omitted.
21. Conduct final inspection in the company of the ENGINEER, the OWNER, and the CONTRACTOR, and prepare a final punch list of items to be completed or corrected.
22. Verify that all items on the punch list have been completed or corrected and make recommendations to the ENGINEER concerning acceptance.

Limitations of Authority. Except upon written instruction of the ENGINEER, the Inspector:

1. Shall not authorize any deviation from the Contract Documents or approve any substitute material or equipment.
2. Shall not exceed limitations on the ENGINEER's authority as set forth in the Contract Documents.
3. Shall not undertake any of the responsibilities of the CONTRACTOR, Subcontractors or CONTRACTOR's superintendent, or expedite the WORK.
4. Shall not advise on or issue directions relative to any aspect of the means, methods, techniques, sequences, or procedures of construction unless such is specifically called for in the Contract Documents.
5. Shall not advise on or issue directions as to safety precautions and programs in connection with the WORK.

9.4 CLARIFICATIONS AND INTERPRETATIONS. The ENGINEER will issue with reasonable promptness such written clarifications or interpretations of the requirements of the Contract

SECTION 00700 - GENERAL CONDITIONS

Documents (in the form of Drawings or otherwise) as the ENGINEER may determine necessary, which shall be consistent with, or reasonably inferred from, the overall intent of the Contract Documents.

- 9.5 AUTHORIZED VARIATIONS IN WORK. The ENGINEER may authorize variations in the WORK from the requirements of the Contract Documents. These may be accomplished by a Field Order and will require the CONTRACTOR to perform the WORK involved in a manner that minimizes the impact to the WORK and the contract completion date. If the CONTRACTOR believes that a Field Order justifies an increase in the Contract Price or an extension of the Contract Time, the CONTRACTOR may make a claim therefor as provided in Article 11 or 12.
- 9.6 REJECTING DEFECTIVE WORK. The ENGINEER will have authority to reject WORK which the ENGINEER believes to be defective and will also have authority to require special inspection or testing of the WORK as provided in Paragraph 13.3G, whether or not the WORK is fabricated, installed, or completed.
- 9.7 CONTRACTOR SUBMITTALS, CHANGE ORDERS, AND PAYMENTS
- A. In accordance with the procedures set forth in the General Requirements, the ENGINEER will review all CONTRACTOR submittals, including Shop Drawings, samples, substitutes, or "or equal" items, etc., in order to determine if the items covered by the submittals will, after installation or incorporation in the WORK, conform to the requirements of the Contract Documents and be compatible with the design concept of the completed project as a functioning whole as indicated by the Contract Documents. The ENGINEER's review will not extend to means, methods, techniques, sequences or procedures of construction or to safety precautions or programs incident thereto.
- B. In connection with the ENGINEER's responsibilities as to Change Orders, see Articles 10, 11, and 12.
- C. In connection with the ENGINEER's responsibilities in respect of Applications for Payment, see Article 14.
- 9.8 DECISIONS ON DISPUTES
- A. The ENGINEER will be the initial interpreter of the requirements of the Contract Documents and judge of the acceptability of the WORK thereunder. Claims, disputes, and other matters relating to the acceptability of the WORK; the interpretation of the requirements of the Contract Documents pertaining to the performance of the WORK; and those claims under Articles 11 and 12 in respect to changes in the Contract Price or Contract Time will be referred initially to the ENGINEER in writing with a request for formal decision in accordance with this paragraph, which the ENGINEER will render in writing within 30 days of receipt of the request. Written notice of each such claim, dispute, and other matter will be delivered by the CONTRACTOR to the ENGINEER promptly (but in no event later than 30 days) after the occurrence of the event giving rise thereto. Written supporting data will be submitted to the ENGINEER within 60 days after such occurrence unless the ENGINEER allows an additional period of time to ascertain more accurate data in support of the claim.

SECTION 00700 - GENERAL CONDITIONS

- B. The rendering of a decision by the ENGINEER with respect to any such claim, dispute, or other matter (except any which have been waived by the making or acceptance of final payment as provided in Paragraph 14.12) will be a condition precedent to any exercise by the OWNER or the CONTRACTOR of such rights or remedies as either may otherwise have under the Contract Documents or by Law or Regulations in respect of any such claim, dispute, or other matter.

9.9 LIMITATION ON ENGINEER'S RESPONSIBILITIES

- A. Neither the ENGINEER's authority to act under this Article or other provisions of the Contract Documents nor any decision made by the ENGINEER in good faith either to exercise or not exercise such authority shall give rise to any duty or responsibility of the ENGINEER to the CONTRACTOR, any Subcontractor, any Supplier, any surety for any of them, or any other person or organization performing any of the WORK.
- B. Whenever in the Contract Documents the terms "as ordered," "as directed," "as required," "as allowed," "as reviewed," "as approved," or terms of like effect or import are used, or the adjectives "reasonable," "suitable," "acceptable," "proper," or "satisfactory" or adjectives of like effect or import are used to describe a requirement, direction, review, or judgment of the ENGINEER as to the WORK, it is intended that such requirement, direction, review, or judgment will be solely to evaluate the WORK for compliance with the requirements of the Contract Documents, and conformance with the design concept of the completed Project as a functioning whole as indicated by the Contract Documents, unless there is a specific statement indicating otherwise. The use of any such term or adjective shall not be effective to assign to the ENGINEER any duty or authority to supervise or direct the performance of the WORK or any duty or authority to undertake responsibility contrary to the provisions of Paragraph 9.9C or 9.9D.
- C. The ENGINEER will not supervise, direct, control, or have authority over or be responsible for the CONTRACTOR's means, methods, techniques, sequences, or procedures of construction, or the safety precautions and programs incident thereto, or for any failure of the CONTRACTOR to comply with Laws and Regulations, applicable to the performance of the WORK. The ENGINEER will not be responsible for the CONTRACTOR's failure to perform the WORK in accordance with the Contract Documents.
- D. The ENGINEER will not be responsible for the acts or omissions of the CONTRACTOR nor of any Subcontractor, supplier, or any other person or organization performing any of the WORK.

SECTION 00700 - GENERAL CONDITIONS

ARTICLE 10 CHANGES IN THE WORK

10.1 GENERAL

- A. Without invalidating the Agreement and without notice to any surety, the OWNER may at any time or from time to time, order additions, deletions, or revisions in the WORK; these will be authorized by a written Field Order and/or a Change Order issued by the ENGINEER.
- B. If the CONTRACTOR believes that it is entitled to an increase or decrease in the Contract Price, or an extension or shortening in the Contract Time as the result of a Field Order, a claim may be made as provided in Articles 11 and 12.
- C. If the OWNER and CONTRACTOR agree on the value of any work, or the amount of Contract Time that should be allowed as a result of a Field Order, upon receiving written notice from the ENGINEER, the CONTRACTOR shall proceed so as to minimize the impact on and delays to the work pending the issuance of a Change Order.
- D. If the OWNER and the CONTRACTOR are unable to agree as to the extent, if any, of an increase or decrease in the Contract Price or an extension or shortening of the Contract Time that should be allowed as a result of a Field Order, the ENGINEER can direct the CONTRACTOR to proceed on the basis of Time and Materials so as to minimize the impact on and delays to WORK, and a claim may be made therefor as provided in Articles 11 and 12.
- E. The CONTRACTOR shall not be entitled to an increase in the Contract Price nor an extension of the Contract Time with respect to any work performed that is not required by the Contract Documents as amended, modified, supplemented by Change Order, except in the case of an emergency and except in the case of uncovering work as provided in Paragraph 13.3G.
- F. The OWNER and the CONTRACTOR shall execute appropriate Change Orders covering:
 - 1. changes in the WORK which are ordered by the OWNER pursuant to Paragraph 10.1A;
 - 2. changes required because of acceptance of Defective WORK under Paragraph 13.7;
 - 3. changes in the Contract Price or Contract Time which are agreed to by the parties; or
 - 4. changes in the Contract Price or Contract Times which embody the substance of any written decision rendered by the ENGINEER pursuant to Paragraph 9.8.
- G. If notice of any change is required by the provisions of any Bond to be given to a surety, the giving of any such notice will be the CONTRACTOR's responsibility, and the amount of each applicable Bond shall be adjusted accordingly.

10.2 ALLOWABLE QUANTITY VARIATIONS

- A. In the event of an increase or decrease in Bid item quantity of a unit price contract, the total amount of WORK actually done or materials or equipment furnished shall be paid for according to the unit price established for such WORK under the Contract Documents, wherever such unit price has been established; provided, that an adjustment in the Contract Price may be made for changes which result in an increase or decrease in excess of 25% of

SECTION 00700 - GENERAL CONDITIONS

the estimated quantity of any major item of the WORK. Major Item is defined as any bid item amount that is ten percent (10%) or more of the total contract amount.

- B. In the event a part of the WORK is to be entirely eliminated and no lump sum or unit price is named in the Contract Documents to cover such eliminated work, the price of the eliminated work shall be agreed upon in writing by the OWNER and the CONTRACTOR. If the OWNER and the CONTRACTOR fail to agree upon the price of the eliminated work, said price shall be determined in accordance with the provisions of Article 11.

ARTICLE 11 CHANGE OF CONTRACT PRICE

11.1 GENERAL

- A. The Contract Price constitutes the total compensation payable to the CONTRACTOR for performing the WORK. All duties, responsibilities, and obligations assigned to or undertaken by the CONTRACTOR to complete the WORK shall be at its expense without change in the Contract Price.
- B. The Contract Price may only be changed by a Change Order. Any claim for an increase in the Contract Price shall be based on written notice delivered by the CONTRACTOR to the ENGINEER promptly (but in no event later than 7 days) after the start of the occurrence or the event giving rise to the claim and stating the general nature of the claim. Notice of the amount of the claim with supporting data shall be delivered within 14 days after such occurrence (unless the ENGINEER allows an additional period of time to ascertain more accurate data in support of the claim) and shall be accompanied by the CONTRACTOR's written statement that the amount claimed covers all known amounts (direct, indirect, and consequential) to which the CONTRACTOR is entitled as a result of said occurrence or event. All claims for adjustment in the Contract Price shall be determined by the ENGINEER in accordance with Paragraph 9.8A if the OWNER and the CONTRACTOR cannot otherwise agree on the amount involved. No claim for an adjustment in the Contract Price will be valid if not submitted in accordance with this Paragraph 11.1B.
- C. The value of any WORK covered by a Change Order or of any claim for an increase or decrease in the Contract Price shall be determined in one of the following ways:
 - 1. Where the WORK involved is covered by unit prices contained in the Contract Documents, by application of unit prices to the quantities of the items involved.
 - 2. By mutual acceptance of a lump sum, which may include an allowance for overhead and profit not necessarily in accordance with Paragraph 11.4.
 - 3. On the basis of the cost of WORK (determined as provided in Paragraphs 11.3) plus a CONTRACTOR's fee for overhead and profit (determined as provided in Paragraph 11.4).

- 11.2 COSTS RELATING TO WEATHER. The CONTRACTOR shall have no claims against the OWNER for damages for any injury to WORK, materials, or equipment, resulting from the action of the elements. If, however, in the opinion of the ENGINEER, the CONTRACTOR has made all reasonable efforts to protect the materials, equipment and work, the CONTRACTOR may be granted a reasonable extension of Contract Time to make proper repairs, renewals, and replacements of the work, materials, or equipment.

SECTION 00700 - GENERAL CONDITIONS

11.3 COST OF WORK (BASED ON TIME AND MATERIALS)

- A. General. The term "cost of work" means the sum of all costs necessarily incurred and paid by the CONTRACTOR for labor, materials, and equipment in the proper performance of extra work. Except as otherwise may be agreed to in writing by the OWNER, such costs shall be in amounts no higher than those prevailing in the locality of the Project; shall include only the following items, and shall not include any of the costs itemized in Paragraph 11.5 EXCLUDED COSTS.
- B. Labor. The costs of labor will be the actual cost for wages prevailing for each craft or type of workers performing the extra work at the time the extra work is done, plus employer payments of payroll taxes, worker's compensation insurance, liability insurance, health and welfare, pension, vacation, apprenticeship funds, and other direct costs resulting from Federal, State or local laws, as well as assessments or benefits required by lawful collective bargaining agreements. Labor costs for equipment operators and helpers shall be paid only when such costs are not included in the invoice for equipment rental. The labor costs for forepersons shall be proportioned to all of their assigned work and only that applicable to extra work shall be paid. Non-direct labor costs including superintendence shall be considered part of the mark-up set out in paragraph 11.4.
- C. Materials. The cost of materials reported shall be at invoice or lowest current price at which materials are locally available and delivered to the job in the quantities involved, plus the cost of freight, delivery and storage, subject to the following:
1. Trade discounts available to the purchaser shall be credited to the OWNER notwithstanding the fact that such discounts may not have been taken by the CONTRACTOR.
 2. For materials secured by other than a direct purchase and direct billing to the purchaser, the cost shall be deemed to be the price paid to the actual supplier as determined by the ENGINEER. Mark-up except for actual costs incurred in the handling of such materials will not be allowed.
 3. Payment for materials from sources owned wholly or in part by the purchaser shall not exceed the price paid by the purchaser for similar materials from said sources on extra work items or the current wholesale price for such materials delivered to the work site, whichever price is lower.
 4. If in the opinion of the ENGINEER the cost of material is excessive, or the CONTRACTOR does not furnish satisfactory evidence of the cost of such material, then the cost shall be deemed to be the lowest current wholesale price for the quantity concerned delivered to the work site less trade discount. The OWNER reserves the right to furnish materials for the extra work and no claim shall be allowed by the CONTRACTOR for costs and profit on such materials.
- D. Equipment. The CONTRACTOR will be paid for the use of equipment at the rental rate listed for such equipment specified in the Supplementary General Conditions. Such rental rate will be used to compute payments for equipment whether the equipment is under the CONTRACTOR's control through direct ownership, leasing, renting, or another method of acquisition. The rental rate to be applied for use of each item of equipment shall be the rate resulting in the least total cost to the OWNER for the total period of use. If it is deemed

SECTION 00700 - GENERAL CONDITIONS

necessary by the CONTRACTOR to use equipment not listed in the publication specified in the Supplementary General Conditions, an equitable rental rate for the equipment will be established by the ENGINEER. The CONTRACTOR may furnish cost data which might assist the ENGINEER in the establishment of the rental rate.

1. All equipment shall, in the opinion of the ENGINEER, be in good working condition and suitable for the purpose for which the equipment is to be used.
 2. Before construction equipment is used on the extra work, the CONTRACTOR shall plainly stencil or stamp an identifying number thereon at a conspicuous location, and shall furnish to the ENGINEER, in duplicate, a description of the equipment and its identifying number.
 3. Unless otherwise specified, manufacturer's ratings and manufacturer approved modifications shall be used to classify equipment for the determination of applicable rental rates. Equipment which has no direct power unit shall be powered by a unit of at least the minimum rating recommended by the manufacturer.
 4. Individual pieces of equipment or tools having a replacement value of \$200 or less, whether or not consumed by use, shall be considered to be small tools and no payment will be made therefor.
 5. Rental time will not be allowed while equipment is inoperative due to breakdowns.
 6. Equipment Rental Rates. Unless otherwise agreed in writing, the CONTRACTOR will be paid for the use of equipment at the rental rate listed for such equipment specified in the current edition of the following reference publication: "Rental Rate Blue Book" as published by Dataquest (a company of the Dunn and Bradstreet Corporation), 1290 Ridder Park Drive, San Jose, CA 95131, telephone number (800) 227-8444.
- E. Equipment on the Work Site. The rental time to be paid for equipment on the work site shall be the time the equipment is in productive operation on the extra work being performed and, in addition, shall include the time required to move the equipment to the location of the extra work and return it to the original location or to another location requiring no more time than that required to return it to its original location; except, that moving time will not be paid if the equipment is used on other than the extra work, even though located at the site of the extra work. Loading and transporting costs will be allowed, in lieu of moving time, when the equipment is moved by means other than its own power, except that no payment will be made for loading and transporting costs when the equipment is used at the site of the extra work on other than the extra work. The following shall be used in computing the rental time of equipment on the work site.
1. When hourly rates are listed, any part of an hour less than 30 minutes of operation shall be considered to be 1/2-hour of operation, and any part of an hour in excess of 30 minutes will be considered one hour of operation.
 2. When daily rates are listed, any part of a day less than 4 hours operation shall be considered to be 1/2-day of operation. When owner-operated equipment is used to perform extra work to be paid for on a time and materials basis, the CONTRACTOR will be paid for the equipment and operator, as set forth in Paragraphs (3), (4), and (5), following.
 3. Payment for the equipment will be made in accordance with the provisions in Paragraph 11.3D, herein.
 4. Payment for the cost of labor and subsistence or travel allowance will be made at the rates paid by the CONTRACTOR to other workers operating similar equipment already

SECTION 00700 - GENERAL CONDITIONS

on the work site, or in the absence of such labor, established by collective bargaining agreements for the type of worker and location of the extra work, whether or not the operator is actually covered by such an agreement. A labor surcharge will be added to the cost of labor described herein in accordance with the provisions of Paragraph 11.3B, herein, which surcharge shall constitute full compensation for payments imposed by state and federal laws and all other payments made to or on behalf of workers other than actual wages.

5. To the direct cost of equipment rental and labor, computed as provided herein, will be added the allowances for equipment rental and labor as provided in Paragraph 11.4, herein.
- F. Specialty Work. Specialty work is defined as that work characterized by extraordinary complexity, sophistication, or innovation or a combination of the foregoing attributes which are unique to the construction industry. The following shall apply in making estimates for payment for specialty work:
1. Any bid item of WORK to be classified as Specialty Work shall be listed as such in the Supplementary General Conditions. Specialty work shall be performed by an entity especially skilled in the work to be performed. After validation of invoices and determination of market values by the ENGINEER, invoices for specialty work based upon the current fair market value thereof may be accepted without complete itemization of labor, material, and equipment rental costs.
 2. When the CONTRACTOR is required to perform work necessitating special fabrication or machining process in a fabrication or a machine shop facility away from the job site, the charges for that portion of the work performed at the off-site facility may, by agreement, be accepted as specialty work and accordingly, the invoices for the work may be accepted without detailed itemization.
 3. All invoices for specialty work will be adjusted by deducting all trade discounts offered or available, whether the discounts were taken or not. In lieu of the allowances for overhead and profit specified in Paragraph 11.4, herein, an allowance of 5 percent will be added to invoices for specialty work.
- G. Sureties. All work performed hereunder shall be subject to all of the provisions of the Contract Documents and the CONTRACTOR's sureties shall be bound with reference thereto as under the original Agreement. Copies of all amendments to surety bonds or supplemental surety bonds shall be submitted to the OWNER for review prior to the performance of any work hereunder.

11.4 CONTRACTOR'S FEE

- A. Extra work ordered on the basis of time and materials will be paid for at the actual necessary cost as determined by the ENGINEER, plus allowances for overhead and profit. The allowance for overhead and profit shall include full compensation for superintendence, bond and insurance premiums, taxes, field office expense, extended overhead, home office overhead, and all other items of expense or cost not included in the cost of labor, materials, or equipment provided for under Paragraph 11.3. The allowance for overhead and profit will be made in accordance with the following schedule:

SECTION 00700 - GENERAL CONDITIONS

Actual Overhead and Profit Allowance

Labor.....	15 percent
Materials	10 percent
Equipment.....	10 percent

To the sum of the costs and mark-ups provided for in this Article, one percent shall be added as compensation for bonding.

- B. It is understood that labor, materials, and equipment may be furnished by the CONTRACTOR or by the Subcontractor on behalf of the CONTRACTOR. When all or any part of the extra work is performed by a Subcontractor, the allowance specified herein shall be applied to the labor, materials, and equipment costs of the Subcontractor, to which the CONTRACTOR may add 5 percent of the Subcontractor's total cost for the extra work. Regardless of the number of hierarchical tiers of Subcontractors, the 5 percent increase above the Subcontractor's total cost which includes the allowances for overhead and profit specified herein may be applied one time only.

11.5 EXCLUDED COSTS. The term "Cost of the Work" shall not include any of the following:

- A. Payroll costs and other compensation of CONTRACTOR's officers, executives, principals (of partnership and sole proprietorships), general managers, engineers, estimators, attorneys' auditors, accountants, purchasing and contracting agents, expenditures, timekeepers, clerks and other personnel employed by CONTRACTOR whether at the site or in CONTRACTOR's principal or a branch office for general administration of the work, or not specifically covered by paragraph 11.3, all of which are to be considered administrative costs covered by the CONTRACTOR's fee.
- B. Expenses of CONTRACTOR's principal and branch offices other than CONTRACTOR's office at the site.
- C. Any part of CONTRACTOR's capital expenses, including interest on CONTRACTOR's capital employed for the WORK and charges against CONTRACTOR for delinquent payments.
- D. Cost of premiums for all bonds and for all insurance whether or not CONTRACTOR is required by the Contract Documents to purchase and maintain the same (except for the cost of premiums covered by paragraph 11.4 above).
- E. Costs due to the negligence of CONTRACTOR , any Subcontractor, or anyone directly or indirectly employed by any of them or for whose acts any of them may be liable, including but not limited to, the correction of Defective WORK, disposal of materials or equipment wrongly supplied and making good any damage to property.
- F. Other overhead or general expense costs of any kind and the cost of any item not specifically and expressly included in paragraph 11.4.

SECTION 00700 - GENERAL CONDITIONS

ARTICLE 12 CHANGE OF CONTRACT TIME

12.1 GENERAL

- A. The Contract Time may only be changed by a Change Order. Any claim for an extension of the Contract Time (or Milestones) shall be based on written notice delivered by the CONTRACTOR to the ENGINEER promptly (but in no event later than 30 days) after the occurrence of the event giving rise to the claim and stating the general nature of the claim. Notice of the extent of the claim with supporting data shall be delivered within 60 days after such occurrence (unless the ENGINEER allows an additional period of time to ascertain more accurate data in support of the claim) and shall be accompanied by the CONTRACTOR's written statement that the adjustment claimed is the entire adjustment to which the CONTRACTOR has reason to believe it is entitled as a result of the occurrence of said event. All claims for adjustment in the Contract Time shall be determined by the ENGINEER in accordance with Paragraph 9.8 if the OWNER and the CONTRACTOR cannot otherwise agree. No claim for an adjustment in the Contract Time will be valid if not submitted in accordance with the requirements of this Paragraph 12.1A. An increase in Contract Time does not mean that the Contractor is due an increase in Contract Price. Only compensable time extensions will result in an increase in Contract Price.
- B. All time limits stated in the Contract Documents are of the essence of the Agreement.
- C. Where CONTRACTOR is prevented from completing any part of the WORK within the Contract Times (or Milestones) due to delay beyond the control of CONTRACTOR, the Contract Times (or Milestones) will be extended in an amount equal to the time lost on the critical path of the project due to such delay if a claim is made therefor as provided in paragraph 12.1. Delays beyond the control of CONTRACTOR shall include, but not be limited to, acts or neglect by OWNER, acts or neglect of utility owners or other contractors performing other work as contemplated by Article 7, fires, floods, epidemics, unprecedented weather conditions or acts of God. Delays attributable to and within the control of a Subcontractor or Supplier shall be deemed to be delays within the control of CONTRACTOR.
- D. Where CONTRACTOR is prevented from completing any part of the WORK within the Contract Times (or Milestones) due to delay beyond the control of both OWNER and CONTRACTOR, an extension of the Contract Times (or Milestones) in an amount equal to the time lost on the critical path of the project due to such delay shall be CONTRACTOR's sole and exclusive remedy for such delay. In no event shall the OWNER be liable to CONTRACTOR, any Subcontractor, any Supplier, or any other person or organization, or to any surety for or employee or agent of any of them, for damages arising out of or resulting from (i) delays caused by or within the control of CONTRACTOR, or (ii) delays beyond the control of both parties including but not limited to fires, floods, epidemics abnormal weather conditions, acts of God or acts or neglect by utility owners or other contractors performing other work as contemplated by Article 7.

- 12.2 EXTENSIONS OF TIME FOR DELAY DUE TO WEATHER. Contract Time may be extended by the ENGINEER because of delays in completion of the WORK due to unusually severe weather, provided that the CONTRACTOR shall, within 10 days of the beginning of any such delay, notify the ENGINEER in writing of the cause of delay and request an extension of Contract Time. The

SECTION 00700 - GENERAL CONDITIONS

ENGINEER will ascertain the facts and the extent of the delay and extend the time for completing the work when, in the ENGINEER's judgment, the findings of fact justify such an extension. Unprecedented, abnormal, or unusually severe weather will be defined as an event, or events, with a greater than 50-year recurrence interval, as determined by the National Weather Service, or equivalent State or Federal agency

ARTICLE 13 WARRANTY AND GUARANTEE; TESTS AND INSPECTIONS; CORRECTION, REMOVAL, OR ACCEPTANCE OF DEFECTIVE WORK

- 13.1 **WARRANTY AND GUARANTEE.** The CONTRACTOR warrants and guarantees to the OWNER and the ENGINEER that all work will be in accordance with the Contract Documents and will not be defective. Prompt notice of defects known to the OWNER or ENGINEER shall be given to the CONTRACTOR. All defective work, whether or not in place, may be rejected, corrected, or accepted as provided in this Article 13.
- 13.2 **ACCESS TO WORK.** OWNER, ENGINEER, their Consultants, sub-consultants, other representatives and personnel of OWNER, independent testing laboratories and governmental agencies with jurisdictional interests will have access to the WORK at reasonable times for their observation, inspecting and testing. CONTRACTOR shall provide them proper and safe conditions for such access and advise them of CONTRACTOR's site safety procedures and programs so that they may comply therewith as applicable.
- 13.3 **TESTS AND INSPECTIONS**
- A. The CONTRACTOR shall give the ENGINEER timely notice of readiness of the WORK for all required inspections, tests, or approvals, and shall cooperate with inspection and testing personnel to facilitate required inspections or tests.
 - B. If Laws or Regulations of any public body having jurisdiction other than the OWNER require any WORK to specifically be inspected, tested, or approved, the CONTRACTOR shall pay all costs in connection therewith. The CONTRACTOR shall also be responsible for and shall pay all costs in connection with any inspection or testing required in connection with the OWNER's or the ENGINEER's acceptance of a Supplier of materials or equipment proposed as a substitution or (or-equal) to be incorporated in the WORK, or of materials or equipment submitted for review prior to the CONTRACTOR's purchase thereof for incorporation in the WORK. The cost of all inspections, tests, and approvals in addition to the above which are required by the Contract Documents shall be paid by the OWNER (unless otherwise specified).
 - C. The ENGINEER will make, or have made, such inspections and tests as the ENGINEER deems necessary to see that the WORK is being accomplished in accordance with the requirements of the Contract Documents. Unless otherwise specified in the Supplementary General Conditions, the cost of such inspection and testing will be borne by the OWNER. In the event such inspections or tests reveal non-compliance with the requirements of the Contract Documents, the CONTRACTOR shall bear the cost of corrective measures deemed necessary by the ENGINEER, as well as the cost of subsequent reinspection and retesting. Neither observations by the ENGINEER nor inspections, tests, or approvals by others shall relieve the CONTRACTOR from the CONTRACTOR's obligation to perform the WORK in accordance with the Contract Documents.

SECTION 00700 - GENERAL CONDITIONS

- D. All inspections, tests, or approvals other than those required by Laws or Regulations of any public body having jurisdiction shall be performed by organizations acceptable to the ENGINEER and the CONTRACTOR.
 - E. If any WORK (including the work of others) that is to be inspected, tested, or approved is covered without written concurrence of the ENGINEER, it must, if requested by the ENGINEER, be uncovered for observation. Such uncovering shall be at the CONTRACTOR's expense unless the CONTRACTOR has given the ENGINEER timely notice of the CONTRACTOR's intention to perform such test or to cover the same and the ENGINEER has not acted with reasonable promptness in response to such notice.
 - F. If any WORK is covered contrary to the written request of the ENGINEER, it must, if requested by the ENGINEER, be uncovered for the ENGINEER's observation and recovered at the CONTRACTOR's expense.
 - G. If the ENGINEER considers it necessary or advisable that covered WORK be observed by the ENGINEER or inspected or tested by others, the CONTRACTOR, at the ENGINEER's request, shall uncover, expose, or otherwise make available for observation, inspection, or testing as the ENGINEER may require, that portion of the WORK in question, furnishing all necessary labor, material, and equipment. If it is found that such WORK is defective, the CONTRACTOR shall bear all direct, indirect, and consequential costs and damages of such uncovering, exposure, observation, inspection, and testing and of satisfactory reconstruction, including but not limited to fees and charges of engineers, attorneys, and other professionals. However, if such WORK is not found to be defective, the CONTRACTOR shall be allowed an increase in the Contract Price or an extension of the Contract Time, or both, directly attributable to such uncovering, exposure, observation, inspection, testing, and reconstruction; and, if the parties are unable to agree as to the amount or extent thereof, the CONTRACTOR may make a claim therefor as provided in Articles 11 and 12.
- 13.4 OWNER MAY STOP THE WORK. If the WORK is defective, or the CONTRACTOR fails to perform work in such a way that the completed WORK will conform to the Contract Documents, the OWNER may order the CONTRACTOR to stop the WORK, or any portion thereof, until the cause for such order has been eliminated; however, this right of the OWNER to stop the WORK shall not give rise to any duty on the part of the OWNER to exercise this right for the benefit of the CONTRACTOR or any other party.
- 13.5 CORRECTION OR REMOVAL OF DEFECTIVE WORK. If required by the ENGINEER, the CONTRACTOR shall promptly, either correct all defective work, whether or not fabricated, installed, or completed, or, if the WORK has been rejected by the ENGINEER, remove it from the site and replace it with non-defective work. The CONTRACTOR shall bear all direct, indirect and consequential costs and damages of such correction or removal, including but not limited to fees and charges of engineers, attorneys, and other professionals made necessary thereby.

SECTION 00700 - GENERAL CONDITIONS

13.6 ONE YEAR CORRECTION PERIOD

- A. If within one year after the date of Substantial Completion or such longer period of time as may be prescribed by Laws or Regulations or by the terms of any applicable special guarantee required by the Contract Documents or by any specific provision of the Contract Documents, any work is found to be defective, the CONTRACTOR shall promptly, without cost to the OWNER and in accordance with OWNER's written notification, (i) correct such Defective WORK, or, if it has been rejected by the OWNER, remove it from the site and replace it with non-defective work, and (ii) satisfactorily correct or remove and replace any damage to other work of others resulting therefrom. If the CONTRACTOR does not promptly comply with such notification, or in an emergency where delay would cause serious risk of loss or damage, the OWNER may have the Defective WORK corrected or the rejected WORK removed and replaced, and all direct, indirect, and consequential costs and damages of such removal and replacement including but not limited to fees and charges of engineers, attorneys and other professionals will be paid by the CONTRACTOR.
- B. Where Defective WORK (and damage to other WORK resulting therefrom) has been corrected, removed or replaced under this paragraph 13.6, the correction period hereunder with respect to such WORK will be extended for an additional period of one year after such correction or removal and replacement has been satisfactorily completed.

13.7 ACCEPTANCE OF DEFECTIVE WORK. If, instead of requiring correction or removal and replacement of defective work, the OWNER prefers to accept the WORK, the OWNER may do so. The CONTRACTOR shall bear all direct, indirect, and consequential costs attributable to the OWNER's evaluation of and determination to accept such defective work. If any such acceptance occurs prior to final payment, a Change Order will be issued incorporating the necessary revisions in the Contract Documents with respect to the WORK, and the OWNER shall be entitled to an appropriate decrease in the Contract Price.

ARTICLE 14 PAYMENTS TO CONTRACTOR AND COMPLETION

14.1 SCHEDULE OF VALUES (LUMP SUM PRICE BREAKDOWN). The schedule of values or lump sum price breakdown established as provided in the General Requirements shall serve as the basis for progress payments and will be incorporated into a form of Application for Payment acceptable to the ENGINEER.

14.2 UNIT PRICE BID SCHEDULE. Progress payments on account of Unit Price work will be based on the number of units completed.

14.3 APPLICATION FOR PROGRESS PAYMENT

- A. Unless otherwise prescribed by law, on the 25th of each month, the CONTRACTOR shall submit to the ENGINEER for review, an Application for Payment filled out and signed by the CONTRACTOR covering the WORK completed as of the date of the Application and accompanied by such supporting documentation as is required by the Contract Documents.
- B. The Application for Payment shall identify, as a sub-total, the amount of the CONTRACTOR'S Total Earnings to Date, plus the Value of Materials Stored at the Site which have not yet been incorporated in the WORK, and less a deductive adjustment for

SECTION 00700 - GENERAL CONDITIONS

materials installed which were not previously incorporated in the WORK, but for which payment was allowed under the provisions for payment for Materials Stored at the Site, but not yet incorporated in the WORK.

- C. The Net Payment Due the CONTRACTOR shall be the above-mentioned subtotal from which shall be deducted the total amount of all previous payments made to the CONTRACTOR. Progress payments will be paid in full in accordance with Article 14 of the General Conditions until 90% of the Contract Price has been paid. The remaining 10% of the Contract Price amount may be withheld until:

1. final inspection has been made;
2. completion of the Project; and
3. acceptance of the Project by the OWNER.

- D. The Value of Materials Stored at the Site shall be an amount equal to the specified percent of the value of such materials as set forth in the Supplementary General Conditions. Said amount shall be based upon the value of all acceptable materials and equipment not incorporated in the WORK but delivered and suitably stored at the site or at another location agreed to in writing; provided, each such individual item has a value of more than \$5,000.00 and will become a permanent part of the WORK. The Application for Payment shall also be accompanied by an invoice (including shipping), a certification that the materials meet the applicable contract specifications, and any evidence required by the OWNER that the materials and equipment are covered by appropriate property insurance and other arrangements to protect the OWNER's interest therein, all of which will be satisfactory to the OWNER. Payment for materials will not constitute final acceptance. It shall be the CONTRACTOR's responsibility to protect the material from damage, theft, loss, or peril while in storage. Unless otherwise prescribed by law, the Value of Materials Stored at the Site shall be paid at the invoice amount up to a maximum of 85% of the Contract Price for those items.

- 14.4 CONTRACTOR'S WARRANTY OF TITLE. The CONTRACTOR warrants and guarantees that title to all work, materials, and equipment covered by an Application for Payment, whether incorporated in the WORK or not, will pass to the OWNER no later than the time of payment free and clear of all liens.

14.5 REVIEW OF APPLICATIONS FOR PROGRESS PAYMENT

- A. The ENGINEER will, within 7 days after receipt of each Application for Payment, either indicate in writing a recommendation of payment and present the Application to the OWNER, or return the Application to the CONTRACTOR indicating in writing the ENGINEER's reasons for refusing to recommend payment. In the later case, the CONTRACTOR may make the necessary corrections and resubmit the Application. If the ENGINEER still disagrees with a portion of the Application, it will submit the Application recommending the undisputed portion of the Application to the OWNER for payment and provide reasons for recommending non-payment of the disputed amount. Thirty days after presentation of the Application for Payment with the ENGINEER's recommendation, the amount recommended will (subject to the provisions of Paragraph 14.5B) become due and when due will be paid by the OWNER to the CONTRACTOR.

SECTION 00700 - GENERAL CONDITIONS

- B. The OWNER may refuse to make payment of the full amount recommended by the ENGINEER because claims have been made against the OWNER on account of the CONTRACTOR's performance of the WORK or Liens have been filed in connection with the WORK or there are other items entitling the OWNER to a credit against the amount recommended, but the OWNER must give the CONTRACTOR written notice within 7 days (with a copy to the ENGINEER) stating the reasons for such action.

14.6 PARTIAL UTILIZATION

- A. The OWNER shall have the right to utilize or place into service any item of equipment or other usable portion of the WORK prior to completion of the WORK. Whenever the OWNER plans to exercise said right, the CONTRACTOR will be notified in writing by the OWNER, identifying the specific portion or portions of the WORK to be so utilized or otherwise placed into service.
- B. It shall be understood by the CONTRACTOR that until such written notification is issued, all responsibility for care and maintenance of all of the WORK shall be borne by the CONTRACTOR. Upon issuance of said written notice of partial utilization, the OWNER will accept responsibility for the protection and maintenance of all such items or portions of the WORK described in the written notice.
- C. The CONTRACTOR shall retain full responsibility for satisfactory completion of the WORK, regardless of whether a portion thereof has been partially utilized by the OWNER and the CONTRACTOR's one year correction period shall commence only after the date of Substantial Completion for the WORK.

14.7 **SUBSTANTIAL COMPLETION.** When the CONTRACTOR considers the WORK ready for its intended use the CONTRACTOR shall notify the OWNER and the ENGINEER in writing that the WORK is substantially complete. The CONTRACTOR will attach to this request a list of all work items that remain to be completed and a request that the ENGINEER prepare a Notice of Completion. Within a reasonable time thereafter, the OWNER, the CONTRACTOR, and the ENGINEER shall make an inspection of the WORK to determine the status of completion. If the ENGINEER does not consider the WORK substantially complete, or the list of remaining work items to be comprehensive, the ENGINEER will notify the CONTRACTOR in writing giving the reasons therefor. If the ENGINEER considers the WORK substantially complete, the ENGINEER will prepare and deliver to the OWNER, for its execution and recording, the Notice of Completion signed by the ENGINEER and CONTRACTOR, which shall fix the date of Substantial Completion.

14.8 **FINAL APPLICATION FOR PAYMENT.** After the CONTRACTOR has completed all of the remaining work items referred to in Paragraph 14.7 and delivered all maintenance and operating instructions, schedules, guarantees, Bonds, certificates of inspection, record as-built documents (as provided in the General Requirements) and other documents, all as required by the Contract Documents, and after the ENGINEER has indicated that the WORK is acceptable, the CONTRACTOR may make application for final payment following the procedure for progress payments. The final Application for Payment shall be accompanied by all documentation called for in the Contract Documents, together with complete and legally effective releases or waivers (satisfactory to the OWNER) of all liens arising out of or filed in connection with the WORK.

SECTION 00700 - GENERAL CONDITIONS

14.9 FINAL PAYMENT AND ACCEPTANCE

- A. If, on the basis of the ENGINEER's observation of the WORK during construction and final inspection, and the ENGINEER's review of the final Application for Payment and accompanying documentation, all as required by the Contract Documents, the ENGINEER is satisfied that the WORK has been completed and the CONTRACTOR's other obligations under the Contract Documents have been fulfilled, the ENGINEER will, within 14 days after receipt of the final Application for Payment, indicate in writing the ENGINEER's recommendation of payment and present the Application to the OWNER for payment.
- B. After acceptance of the WORK by the OWNER's governing body, the OWNER will make final payment to the CONTRACTOR of the amount remaining after deducting all prior payments and all amounts to be kept or retained under the provisions of the Contract Documents, including the following items:
 - 1. Liquidated damages, as applicable.
 - 2. Two times the value of outstanding items of correction work or punch list items yet uncompleted or uncorrected, as applicable. All such work shall be completed or corrected to the satisfaction of the OWNER within the time stated on the Notice of Completion, otherwise the CONTRACTOR does hereby waive any and all claims to all monies withheld by the OWNER to cover the value of all such uncompleted or uncorrected items.

14.10 RELEASE OF RETAINAGE AND OTHER DEDUCTIONS

- A. After executing the necessary documents to initiate the lien period, and not more than 45 days thereafter (based on a 30-day lien filing period and 15-day processing time), the OWNER will release to the CONTRACTOR the retainage funds withheld pursuant to the Agreement, less any deductions to cover pending claims against the OWNER pursuant to Paragraph 14.5B.
- B. After filing of the necessary documents to initiate the lien period, the CONTRACTOR shall have 30 days to complete any outstanding items of correction work remaining to be completed or corrected as listed on a final punch list made a part of the Notice of Completion. Upon expiration of the 45 days, referred to in Paragraph 14.10A, the amounts withheld pursuant to the provisions of Paragraph 14.9B herein, for all remaining work items will be returned to the CONTRACTOR; provided, that said work has been completed or corrected to the satisfaction of the OWNER within said 30 days. Otherwise, the CONTRACTOR does hereby waive any and all claims for all monies withheld by the OWNER under the Contract to cover 2 times the value of such remaining uncompleted or uncorrected items.

- 14.11 CONTRACTOR'S CONTINUING OBLIGATION. The CONTRACTOR's obligation to perform and complete the WORK in accordance with the Contract Documents shall be absolute. Neither recommendation of any progress or final payment by the ENGINEER, nor the issuance of a Notice of Completion, nor any payment by the OWNER to the CONTRACTOR under the Contract Documents, nor any use or occupancy of the WORK or any part thereof by the OWNER, nor any act of acceptance by the OWNER nor any failure to do so, nor any review of a Shop Drawing or sample submittal, will constitute an acceptance of work not in accordance with the Contract Documents or a release of the CONTRACTOR's obligation to perform the WORK in accordance with the Contract Documents.

SECTION 00700 - GENERAL CONDITIONS

- 14.12 FINAL PAYMENT TERMINATES LIABILITY OF OWNER. Final payment is defined as the last progress payment made to the CONTRACTOR for earned funds, less monies withheld as applicable, pursuant to Paragraph 14.10A. The acceptance by the CONTRACTOR of the final payment referred to in Paragraph 14.9 herein, shall be a release of the OWNER and its agents from all claims of liability to the CONTRACTOR for anything done or furnished for, or relating to, the WORK or for any act of neglect of the OWNER or of any person relating to or affecting the WORK, except demands against the OWNER for the remainder, if any, of the amounts kept or retained under the provisions of Paragraph 14.9 herein; and excepting pending, unresolved claims filed prior to the date of the Notice of Completion.

ARTICLE 15 SUSPENSION OF WORK AND TERMINATION

- 15.1 SUSPENSION OF WORK BY OWNER. The OWNER, acting through the ENGINEER, may, at any time and without cause, suspend the WORK or any portion thereof for a period of not more than 90 days by notice in writing to the CONTRACTOR. The CONTRACTOR shall resume the WORK on receipt from the ENGINEER of a notice of resumption of work. The CONTRACTOR shall be allowed an increase in the Contract Price or an extension of the Contract Time, or both, directly attributable to any suspension if the CONTRACTOR makes an approved claim therefor as provided in Articles 11 and 12.
- 15.2 TERMINATION OF AGREEMENT BY OWNER (CONTRACTOR DEFAULT)
- A. In the event of default by the CONTRACTOR, the OWNER may give 10 days written notice to the CONTRACTOR of OWNER's intent to terminate the Agreement and provide the CONTRACTOR an opportunity to remedy the conditions constituting the default. It shall be considered a default by the CONTRACTOR whenever CONTRACTOR shall: (1) declare bankruptcy, become insolvent, or assign its assets for the benefit of its creditors; (2) fail to provide materials or quality of work meeting the requirements of the Contract Documents; (3) disregard or violate provisions of the Contract Documents or ENGINEER's instructions; (4) fail to prosecute the WORK according to the approved progress schedule; or, (5) fail to provide a qualified superintendent, competent workers, or materials or equipment meeting the requirements of the Contract Documents. If the CONTRACTOR fails to remedy the conditions constituting default within the time allowed, the OWNER may then issue the Notice of Termination.
- B. In the event the Agreement is terminated in accordance with Paragraph 15.2A, herein, the OWNER may take possession of the WORK and may complete the WORK by whatever method or means the OWNER may select. The cost of completing the WORK shall be deducted from the balance which would have been due the CONTRACTOR had the Agreement not been terminated and the WORK completed in accordance with the Contract Documents. If such cost exceeds the balance which would have been due, the CONTRACTOR shall pay the excess amount to the OWNER. If such cost is less than the balance which would have been due, the CONTRACTOR shall not have claim to the difference.
- 15.3 TERMINATION OF AGREEMENT BY OWNER (FOR CONVENIENCE). The OWNER may terminate the Agreement at any time if it is found that reasons beyond the control of either the OWNER or CONTRACTOR make it impossible or against the OWNER's interests to complete the WORK. In such a case, the CONTRACTOR shall have no claims against the OWNER except: (1) for

SECTION 00700 - GENERAL CONDITIONS

the value of work performed up to the date the Agreement is terminated; and, (2) for the cost of materials and equipment on hand, in transit, or on definite commitment, as of the date the Agreement is terminated which would be needed in the WORK and which meet the requirements of the Contract Documents. The value of work performed and the cost of materials and equipment delivered to the site, as mentioned above, shall be determined by the ENGINEER in accordance with the procedure prescribed for the making of the final application for payment and payment under Paragraphs 14.8 and 14.9.

- 15.4 TERMINATION OF AGREEMENT BY CONTRACTOR. The CONTRACTOR may terminate the Agreement upon 10 days written notice to the OWNER, whenever: 1) the WORK has been suspended under the provisions of Paragraph 15.1, herein, for more than 90 consecutive days through no fault or negligence of the CONTRACTOR, and notice to resume work or to terminate the Agreement has not been received from the OWNER within this time period; or, 2) the OWNER should fail to pay the CONTRACTOR any monies due him in accordance with the terms of the Contract Documents and within 60 days after presentation to the OWNER by the CONTRACTOR of a request therefor, unless within said 10-day period the OWNER shall have remedied the condition upon which the payment delay was based. In the event of such termination, the CONTRACTOR shall have no claims against the OWNER except for those claims specifically enumerated in Paragraph 15.3, herein, and as determined in accordance with the requirements of said paragraph.

ARTICLE 16 MISCELLANEOUS

- 16.1 GIVING NOTICE. Whenever any provision of the Contract Documents requires the giving of written notice, it will be deemed to have been validly given if delivered in person to the individual or to a member of the firm or to an officer of the corporation for whom it is intended, or if delivered at or sent by registered or certified mail, postage prepaid, to the last business address known to the giver of the notice.

16.2 RIGHTS IN AND USE OF MATERIALS FOUND ON THE WORK

- A. The CONTRACTOR may use on the Project, with ENGINEER's approval, such stone, gravel, sand, or other material determined suitable by the ENGINEER, as may be found in the excavation. The CONTRACTOR will be paid for the excavation of such material at the corresponding contract unit price. No additional payment will be made for utilizing the material from excavation as borrow, or select borrow.
- B. The CONTRACTOR shall replace, at its own expense, with other acceptable material, all of that portion of the excavated material so removed and used which was needed for use on the project. No charge for the materials so used will be made against the CONTRACTOR except that the CONTRACTOR shall be responsible for payment of any royalties required.
- C. The CONTRACTOR shall not excavate or remove any material from within the Project location which is not within the grading limits, as indicated by the slope and grade lines, without written authorization from the ENGINEER.
- D. In the event the CONTRACTOR has processed materials from OWNER-furnished sources in excess of the quantities required for performance of this contract, including any waste material produced as a by-product, the CBJ may retain possession of such materials without obligation to reimburse the CONTRACTOR for the cost of their production. When such

SECTION 00700 - GENERAL CONDITIONS

materials are in a stockpile, the ENGINEER may require: That it remain in stockpile; the CONTRACTOR level such stockpile(s); or that the CONTRACTOR remove such materials and restore the premises to a satisfactory condition at the CONTRACTOR's expense. This provision shall not preclude the CBJ from arranging with the CONTRACTOR to produce material over and above the contract needs, payment for which shall be by written agreement between the CBJ and the CONTRACTOR.

- E. Unless otherwise provided, the material from any existing old structure may be used temporarily by the CONTRACTOR in the erection of the new structure. Such material shall not be cut or otherwise damaged except with the approval of the ENGINEER.
- 16.3 **RIGHT TO AUDIT.** If the CONTRACTOR submits a claim to the OWNER for additional compensation, the OWNER shall have the right, as a condition to considering the claim, and as a basis for evaluation of the claim, and until the claim has been settled, to audit the CONTRACTOR's books to the extent they are relevant. This right shall include the right to examine books, records, documents, and other evidence and accounting procedures and practices, sufficient to discover and verify all direct and indirect costs of whatever nature claimed to have been incurred or anticipated to be incurred and for which the claim has been submitted. The right to audit shall include the right to inspect the CONTRACTOR's plants, or such parts thereof, as may be or have been engaged in the performance of the WORK. The CONTRACTOR further agrees that the right to audit encompasses all subcontracts and is binding upon Subcontractors. The rights to examine and inspect herein provided for shall be exercisable through such representatives as the OWNER deems desirable during the CONTRACTOR's normal business hours at the office of the CONTRACTOR. The CONTRACTOR shall make available to the OWNER for auditing, all relevant accounting records and documents, and other financial data, and upon request, shall submit true copies of requested records to the OWNER.
- 16.4 **ARCHEOLOGICAL OR HISTORICAL DISCOVERIES.** When the CONTRACTOR's operation encounters prehistoric artifacts, burials, remains of dwelling sites, paleontological remains, such as shell heaps, land or sea mammal bones or tusks, or other items of historical significance, the CONTRACTOR shall cease operations immediately and notify the ENGINEER. No artifacts or specimens shall be further disturbed or removed from the ground and no further operations shall be performed at the site until so directed. Should the ENGINEER order suspension of the CONTRACTOR's operations in order to protect an archaeological or historical finding, or order the CONTRACTOR to perform extra work, such order(s) shall be covered by an appropriate contract change document.
- 16.5 **CONSTRUCTION OVER OR ADJACENT TO NAVIGABLE WATERS.** All work over, on, or adjacent to navigable waters shall be so conducted that free navigation of the waterways will not be interfered with and the existing navigable depths will not be impaired, except as allowed by permit issued the U.S. Coast Guard and/or the U.S. Army Corps of Engineers, as applicable.
- 16.6 **GRATUITY AND CONFLICT OF INTEREST.** The CONTRACTOR agrees to not extend any loan, gratuity or gift of money of any form whatsoever to any employee or elected official of the OWNER, nor will the CONTRACTOR rent or purchase any equipment or materials from any employee or elected official of the OWNER, or to the best of the CONTRACTOR's knowledge, from any agent of any employee or elected official of the OWNER. Before final payment, the CONTRACTOR shall execute and furnish the OWNER an affidavit certifying that the CONTRACTOR has complied with the above provisions of the contract.

SECTION 00700 - GENERAL CONDITIONS

16.7 SUITS OF LAW CONCERNING THE WORK

- A. Should a suit of law be entered into, either by the CONTRACTOR (or the CONTRACTOR's surety) against the OWNER, or by the OWNER against the CONTRACTOR (or the CONTRACTOR's surety), the suit of law shall be tried in the First Judicial District of Alaska.
- B. If one of the questions at issue is the satisfactory performance of the work by the CONTRACTOR and should the appropriate court of law judge the work of the CONTRACTOR to be unsatisfactory, then the CONTRACTOR (or the CONTRACTOR's surety) shall reimburse the OWNER for all legal and all other expenses (as may be allowed and set by the court) incurred by the OWNER because of the suit of the law and, further, it is agreed that the OWNER may deduct such expense from any sum or sums then, or any that become due the CONTRACTOR under the contract.

16.8 CERTIFIED PAYROLLS

- A. All CONTRACTORs or Subcontractor who perform work on a public construction contract for the OWNER shall file a certified payroll with the Alaska Department of Labor before Friday of each week that covers the preceding week (Section 14-2-4 ACLA 1949; am Section 4 ch 142 SLA 1972).
- B. In lieu of submitting the State payroll form, the CONTRACTOR's standard payroll form may be submitted, provided it contains the information required by AS 36.05.040 and a statement that the CONTRACTOR is complying with AS 36.10.010.
- C. A contractor or subcontractor, who performs work on public construction in the State, as defined by AS 36.95.010(3), shall pay not less than the current prevailing rate of wages as issued by the Alaska Department of Labor before the end of the pay period. (AS 36.05.010).

16.9 PREVAILING WAGE RATES

- A. Wage rates for Laborers and Mechanics on Public Contracts, AS 36.05.070. The CONTRACTOR, or Subcontractors, shall pay all employees unconditionally and not less than once a week. Wages may not be less than those stated in Paragraph 16.8C, regardless of the contractual relationship between the CONTRACTOR or Subcontractors and laborers, mechanics, or field surveyors. The scale of wages to be paid shall be posted by the CONTRACTOR in a prominent, easily accessible place at the site of the WORK.
- B. Failure to Pay Agreed Wages, AS 36.05.080. If it is found that a laborer, mechanic, or field surveyor employed by the CONTRACTOR or Subcontractor has been, or is being, paid a rate or wages less than the established rate, the OWNER may, by written notice, terminate the CONTRACTOR or Subcontractors right to proceed with the work. The OWNER may prosecute the work to completion by contract or otherwise, and the CONTRACTOR and sureties will be held liable to the OWNER for excess costs for completing the WORK. (Section 2 ch 52 SLA 1959).
- C. Listing Contractor's Who Violate Contracts, AS 36.05.090. In addition, a list giving the names of persons who have disregarded the rights of their employees shall be distributed to all departments of State government and all political subdivisions. No person appearing on this

SECTION 00700 - GENERAL CONDITIONS

list, and no firm, corporation, partnership or association in which the person has an interest, may work as a CONTRACTOR or Subcontractor on a public construction contract for the State, or a political subdivision of the state, until three years after the date of publication of the list. (Section 3 ch 52 SLA 1959; am Section 9 ch 142 SLA).

16.10 EMPLOYMENT REFERENCE. Workers employed in the execution of the contract by the CONTRACTOR or by any Subcontractor under this contract shall not be required or permitted to labor more than 8 hours a day or 40 hours per week in violation of the provisions of the Alaska Wage and Hour Act, Section 23.10.060.

16.11 COST REDUCTION INCENTIVE

- A. At any time within 45 days after the date of the Notice of Award, the CONTRACTOR may submit to the ENGINEER in writing, proposals for modifying the plans, specifications, or other requirements of this contract for the sole purpose of reducing the total cost of construction. The cost reduction proposal shall not impair in any manner the essential functions or characteristics of the project, including but not limited to, service life, economy of operation, ease of maintenance, desired appearance or design and safety standards.
- B. The cost reduction proposal shall contain the following information:
1. Description of both the existing contract requirements for performing the WORK and the proposed changes.
 2. An itemization of the contract requirements that must be changed if the proposal is adopted.
 3. A detailed estimate of the time required and the cost of performing the WORK under both the existing contract and the proposed change.
 4. A statement of the date by which the CONTRACTOR must receive the decision from the OWNER on the cost reduction proposal.
 5. The contract items of WORK effected by the proposed changes including any quantity variations.
 6. A description and estimate of costs the OWNER may incur in implementing the proposed changes, such as test and evaluation and operating and support costs.
 7. A prediction of any effects the proposed change would have on future operations and maintenance costs to the OWNER.
- C. The provisions of this section shall not be construed to require the OWNER to consider any cost reduction proposal which may be submitted; nor will the OWNER be liable to the CONTRACTOR for failure to accept or act upon any cost reduction proposal submitted, or for delays to the work attributable to the consideration or implementation of any such proposal.
- D. If a cost reduction proposal is similar to a change in the plans or specifications for the project under consideration by the OWNER at the time the proposal is submitted, the OWNER will not accept such proposal and reserves the right to make such changes without compensation to the CONTRACTOR under the provisions of this section.
- E. The CONTRACTOR shall continue to perform the work in accordance with the requirements of the contract until an executed Change Order incorporating the cost reduction proposal has

SECTION 00700 - GENERAL CONDITIONS

been issued. If any executed Change Order has not been issued by the date upon which the CONTRACTOR's cost reduction proposal specifies that a decision should be made by the OWNER, in writing, the cost reduction proposal shall be considered rejected.

- F. The OWNER, shall be the sole judge of the acceptability of a cost reduction proposal and of the estimated net savings in Contract Time and construction costs resulting from the adoption of all or any part of such proposal. Should the CONTRACTOR disagree with OWNER's decision on the cost reduction proposal, there is no further consideration. The OWNER reserves the right to make final determination.
- G. If the CONTRACTOR's cost reduction proposal is accepted in whole or in part, such acceptance will be made by a contract Change Order, which specifically states that the change is executed pursuant to this cost reduction proposal section. Such Change Order shall incorporate the changes in the plans and specifications which are necessary to permit the cost reduction proposal or such part of it as has been accepted to be put into effect and shall include any conditions upon which the OWNER's approval is based, if such approval is conditional. The Change Order shall also describe the estimated net savings in the cost of performing the work attributable to the cost reduction proposal, and shall further provide that the contract cost be adjusted by crediting the OWNER with the estimated net savings amount.
- H. Acceptance of the cost reduction proposal and performance of the work does not extend the time of completion of the contract, unless specifically provided in the Change Order authorizing the use of the submitted proposal. Should the adoption of the cost reduction proposal result in a Contract Time savings, the total Contract Time shall be reduced by an amount equal to the time savings realized.
- I. The amount specified to the CONTRACTOR in the Change Order accepted in the cost reduction proposal shall constitute full compensation for the performance of WORK. No claims for additional costs as a result of the changes specified in the cost reduction proposal shall be allowed.
- J. The OWNER reserves the right to adopt and utilize any approved cost reduction proposal for general use on any contract administered when it is determined suitable for such application. Cost reduction proposals identical, similar, or previously submitted will not be accepted for consideration if acceptance and compensation has previously been approved. The OWNER reserves the right to use all or part of any cost reduction proposal without obligation or compensation of any kind to the CONTRACTOR.
- K. The CONTRACTOR shall bear the costs, if any, to revise all bonds and insurance requirements for the project, to include the cost reduction WORK.

END OF SECTION

SECTION 00800 - SUPPLEMENTARY GENERAL CONDITIONS

GENERAL. These Supplementary General Conditions make additions, deletions, or revisions to the General Conditions as indicated herein. All provisions which are not so added, deleted, or revised remain in full force and effect. Terms used in these Supplementary General Conditions which are defined in the General Conditions have the meanings assigned to them in the General Conditions.

SGC 1 DEFINITIONS. *Remove* the definition for Contract Documents and *replace* with the following:

Contract Documents – The Table of Contents, Notice Inviting Bids, Instructions to Bidders, Bid Forms (including the Bid, Bid Schedule(s), Subcontractor Report, Bid Bond, and all required certificates and affidavits), Agreement, Performance Bond, Payment Bond, General Conditions, Supplementary General Conditions, Alaska Labor Standards, Reporting, and Prevailing Wage Rate Determination, Special Provisions, Standard Specifications, Technical Specifications, Drawings, Permits, and all Addenda, and Change Orders executed pursuant to the provisions of the Contract Documents.

SGC 2.2 COPIES OF DOCUMENTS. *Add* the following:

The OWNER shall furnish to the CONTRACTOR two (2) hard copies of the Contract Documents which will include bound reduced Drawings and one (1) electronic copy (pdf format) on a CD-ROM. Additional copies of contract documents are the responsibility of the contractor.

SGC 3.2 ORDER OF PRECEDENCE OF CONTRACT DOCUMENTS. *Remove* No. 12. Technical Specifications and No. 13. Drawings, and *add* the following:

12. Special Provisions Section
13. Standard Specifications for Civil Engineering Projects and Subdivision Improvements
December 2003 Edition with current Errata Sheets.
14. Drawings.

SGC 4.2 PHYSICAL CONDITIONS - SUBSURFACE AND EXISTING STRUCTURES. *Add* the following:

- C. In the preparation of the Contract Documents, the Engineer of Record has relied upon field measurements and visual inspection of the existing structures and surface conditions.

SGC - 4.6 USE OF THE CBJ/STATE LEMON CREEK GRAVEL PIT. *Add* the following.

The CBJ/State Lemon Creek Gravel Pit is not available for this Project.

Add the following SGC 4.7:

SGC 4.7 USE OF CITY/STATE STABLER'S POINT ROCK QUARRY. *Add* the following:

The CBJ/State Stabler's Point Rock Quarry is not available for this Project.

Add the following SGC 4.7:

SECTION 00800 - SUPPLEMENTARY GENERAL CONDITIONS

SGC 5.1 PERFORMANCE, PAYMENT, AND OTHER BONDS. The Contractor shall furnish Performance and Payment Bonds in the amount of 100% of the Bid.

SGC 5.2 INSURANCE AMOUNTS. The limits of liability for the insurance required by Paragraph 5.2 of the General Conditions shall provide coverage for not less than the following amounts or greater where required by Laws and Regulations. The CONTRACTOR must provide certification of proper insurance coverage and amendatory endorsements or copies of the applicable policy language affecting coverage required in this agreement to the City and Borough of Juneau. All certificates of insurance supplied to the OWNER shall state that the OWNER is named as **“Additional Insured for any and all work performed for the City & Borough of Juneau” for the Commercial General Liability policy and any other policies, if required in this Section.** NOTE: This requirement has changed. The OWNER no longer requires certificates of insurance referencing project names and contract numbers.

Delete paragraph C and *Replace* with the following paragraph C:

- C. The CONTRACTOR shall furnish the OWNER with certificates showing the type, amount, class of operations covered, effective dates and dates of expiration of policies. Failure of CBJ to demand such certificate or other evidence of full compliance with these insurance requirements or failure of CBJ to identify a deficiency from evidence that is provided shall not be construed as a waiver of the obligation of the Contractor to maintain the insurance required by this contract. The coverage afforded will not be cancelled, reduced in coverage, or renewal refused until at least 30 days' prior written notice has been given to the OWNER by the CONTRACTOR. **All such insurance required herein (except for Workers' Compensation and Employer's Liability) shall name the OWNER, its Consultants and subconsultants and their officers, directors, agents, and employees as "additional insureds" under the policies.**

The CONTRACTOR shall purchase and maintain the following insurance:

1. Workers' Compensation and Employer's Liability. This insurance shall protect the CONTRACTOR against all claims under applicable state workers' compensation laws. The CONTRACTOR shall also be protected against claims for injury, disease, or death of employees which, for any reason, may not fall within the provisions of a Workers' Compensation law. The CONTRACTOR shall require each Subcontractor similarly to provide Workers' Compensation Insurance for all of the latter's employees to be engaged in such work unless such employees are covered by the protection afforded by the CONTRACTOR's Workers' Compensation Insurance. In case any class of employees is not protected, under the Workers' Compensation Statute, the CONTRACTOR shall provide and shall cause each subcontractor to provide adequate employer's liability insurance for the protection of such of its employees as are not otherwise protected. **The CONTRACTOR grants a waiver of any right to subrogation against the OWNER by virtue of the payment of any loss under such insurance.** This provision applies regardless of whether or not the OWNER has received a waiver of subrogation endorsement from the insurer.

Workers' Compensation: (under Paragraph 5.2C.1 of the General Conditions) as in accordance with AS 23.30.045:

- a. State: Statutory
- b. Applicable Federal (e.g., Longshore): Statutory

Note: If the WORK called for in the Contract Documents involves work in or on any

SECTION 00800 - SUPPLEMENTARY GENERAL CONDITIONS

navigable waters, the CONTRACTOR shall provide Workers' Compensation coverage which shall include coverage under the Longshore and Harbor Workers' Compensation Act, the Jones Act, and any other coverage required under Federal or State laws pertaining to workers in or on navigable waters.

a. Employers Liability

Bodily Injury by Accident:	\$100,000.00 Each Accident
Bodily Injury by Disease:	\$100,000.00 Each Employee
Bodily Injury by Disease:	\$500,000.00 Policy Limit

1. CONTRACTOR agrees to waive all rights of subrogation against the OWNER for WORK performed under contract.
2. If CONTRACTOR directly utilizes labor outside of the State of Alaska in the prosecution of the WORK, "Other States" endorsement shall be required as a condition of the contract.

2. Commercial General Liability (CGL), including products and completed operations, property damage, bodily injury and personal and advertising injury, with limits no less than \$1,000,000 each occurrence and \$2,000,000 aggregate. (under Paragraph 5.2C.2 of the General Conditions) **This insurance policy is to contain, or be endorsed to contain, additional insured status for the CBJ, its officers, officials, employees, and volunteers.** If Additional insured status is provided in the form of an endorsement to the Contractor's insurance, the endorsement shall be at least as broad as ISO Form CG 20 10 11 85 or **both** CG 20 10, CG 20 26, CG 20 33, or CG 20 38; **and** CG 20 37 forms if later revisions used).

3. Commercial Automobile Liability: (under Paragraph 5.2C.3 of the General Conditions) including Owned, Hired, and Non-Owned Vehicles:

Combined Single Limit, Bodily Injury and Property Damage	\$1,000,000.00
--	----------------

This insurance policy is to contain, or be endorsed to contain, additional insured status for the CBJ, its officers, officials, employees, and volunteers The CONTRACTOR shall require each Subcontractor similarly to provide Commercial Automobile Liability Insurance for all of the latter's employees to be engaged in such WORK unless such employees are covered by the protection afforded by the CONTRACTOR's Commercial Automobile Liability Insurance.

Add the following paragraphs:

- C. Builder's Risk: CONTRACTOR is not required to obtain a Builder's Risk insurance policy for this project.
- D. All Subcontractors are required to secure and maintain the insurance coverages listed above, unless otherwise noted.
- E. If the CONTRACTOR maintains higher limits than the minimums shown above, the OWNER requires and shall be entitled to coverage for the higher limits maintained by the CONTRACTOR. Any available insurance proceeds in excess of the specified minimum limits of insurance and coverage

SECTION 00800 - SUPPLEMENTARY GENERAL CONDITIONS

shall be available to the OWNER.

- F. Policies shall also specify insurance provided by CONTRACTOR will be considered primary and not contributory to any other insurance available to the OWNER.
- G. Should any of the policies described above be cancelled before the expiration date thereof, notice will be delivered in accordance with the policy provisions.

SGC 6.5 CONCERNING SUBCONTRACTORS, SUPPLIERS, AND OTHERS. *Add* the following:

B. The CONTRACTOR shall perform not less than 40% of the WORK with its own forces (i.e., without subcontracting). The 40% requirement shall be understood to mean that the CONTRACTOR shall perform, with its own organization, WORK amounting to at least 40% of the original contract amount. The 40% requirement will be calculated based upon the total of the subcontract amounts submitted for Contract Award, and any other information requested by the OWNER from the apparent low Bidder.

SGC 6.5 CONCERNING SUBCONTRACTORS, SUPPLIERS, AND OTHERS, *Add* the following paragraph:

C. CONTRACTOR must pay Subcontractors and/or Suppliers within 30 days of receiving payment from the OWNER, if that payment was made for Work performed by the Subcontractor and/or materials received. Failure to pay Subcontractors within 30 days of receiving payment from which Subcontractor and/or Supplier is to be paid may result in the OWNER initiating debarment proceedings as prescribed in the City and Borough of Juneau Purchasing Code. *The 30 day City and Borough of Juneau requirement does not supersede AS 36.90.210.*

SGC 6.6 PERMITS, *Add* the following paragraph:

D. Contractor is responsible for obtaining a Hot Works permit from the CBJ Permit Center, if performing work which requires such a permit. Work requiring a Hot Works Permit includes but is not limited to the following: cutting, welding, Thermit welding, brazing, soldering, grinding, thermal spraying, thawing pipe, installation of torch-applied roof systems or any other similar activity.

SGC 14.3 APPLICATION FOR PROGRESS PAYMENT. Paragraph D.

D. The Value of Materials Stored at the site shall be an amount equal to 85%.

SGC 14.9 FINAL PAYMENT AND ACCEPTANCE. *Add* the following paragraph:

C. Prior to the final payment the CONTRACTOR shall contact the Alaska Department of Labor and Workforce Development (ADOL) and provide the OWNER with clearance from the ADOL for the CONTRACTOR and all Subcontractors that have worked on the Project. This clearance shall indicate that all Employment Security Taxes have been paid. A sample form for this purpose is at the end of this section. The CONTRACTOR shall also submit a "NOTICE OF COMPLETION OF PUBLIC WORKS" signed by ADOL.

SGC 16.8 CERTIFIED PAYROLLS. *Change* paragraph A. to read:

SECTION 00800 - SUPPLEMENTARY GENERAL CONDITIONS

- A. All CONTRACTORS or Subcontractors who perform work on a public construction contract for the OWNER shall file a certified payroll with Alaska Department of Labor. See Section 00830 - Alaska Labor Standards, Reporting, and Prevailing Wage Rate Determination.

Add the following SGC 17:

SGC 17 GENERAL INFORMATION. This Project is currently funded by the City and Borough of Juneau, Alaska .

END OF SECTION



Tax Clearance Request Form for Contractors

Date of request: _____

Business name of the contractor a Tax Clearance is being requested for: _____

Business address: _____

Business contact phone number: _____

Federal Identification Number: _____

Alaska Employer Account Number: _____

Specific time period a tax clearance is being requested for (*i.e. beginning and ending date of a subcontract agreement*):

Subcontract project name: _____

Name and address of the person this Tax Clearance is to be returned to: _____

Comments or additional information: _____

For agency use only:

- Tax Clearance is granted
- Tax Clearance is not granted (*please have employer contact the department*)
- No account on file, liability unknown (*please have employer contact the department*)
- Employer has stated no employees, Tax Clearance not required.

Agency representative signature: _____ Date: _____

Agency representative title: _____

**SECTION 00830 - ALASKA LABOR STANDARDS, REPORTING, AND
PREVAILING WAGE RATE DETERMINATION**

State of Alaska, Department of Labor, Laborers' and Mechanics' Minimum Rates of Pay, AS 36.05.010 and AS 36.05.050, Wage and Hour Administration Pamphlet No. 600, the latest edition published by the State of Alaska, Department of Labor inclusive, are made a part of this contract by reference.

The CONTRACTOR is responsible for contacting the Alaska Department of Labor to determine compliance with current regulations.

Correspondence regarding Title 36 requirements may be submitted electronically or paper copies can be submitted by mail. To submit Title 36 documents electronically, go to <https://myalaska.state.ak.us/home/app>. If filing electronically, submit certified payrolls to ADOL at the website above and email a copy of all certified payrolls to Greg Smith at the email address below. If Contractor elects to submit paper copies, they should be submitted to the physical addresses below.

Within 10 Days of "Notice of Award/Notice to Proceed" make a list of **all** Subcontractors. Include their name, address, phone, estimated subcontract amount, and estimated start and finish dates. Send this list to the Wage and Hour Section (contact information below).

Certified Payrolls must be submitted every two weeks. Before the second Friday, each CONTRACTOR and Subcontractor must file Certified Payrolls with Statements of Compliance for the previous two weeks. Indicate "**Start**" on your first payroll, and "**Final**" on your last payroll for this Project.

As part of the **final payment request package**, CONTRACTOR must submit a "NOTICE OF COMPLETION OF PUBLIC WORKS" form signed by ADOL personnel.

Contact Information:

Wage and Hour Section
State of Alaska
Department of Labor and Workforce Development
Labor Standards and Safety Division and
Wage and Hour Administration
P.O. Box 11149
Juneau, AK 99811-1149
907-465-4842
<http://labor.state.ak.us/lss/home.htm>

Greg Smith, Contract Administrator
City and Borough of Juneau
155 S. Seward Street
Juneau, AK 99801
(907) 586-0873
Greg.Smith@juneau.org

END OF SECTION

SECTION 00830

APPENDIX A

Laborers' & Mechanics'
Minimum Rates of Pay

Pamphlet 600

Effective September 1, 2020



Laborers' and Mechanics' MINIMUM RATES OF PAY

Effective September 1, 2020
Issue 41

PAMPHLET No. 600

Title 36. Public Contracts
AS 36.05

DEPARTMENT OF LABOR
AND WORKFORCE DEVELOPMENT
Wage and Hour Administration

- This page intentionally left blank -



THE STATE
of ALASKA
GOVERNOR MIKE DUNLEAVY

Department of Labor and Workforce Development

Office of the Commissioner

Post Office Box 111149
Juneau, Alaska 99811
Main: 907.465.2700
fax: 907.465-2784

September 1, 2020

TO ALL CONTRACTING AGENCIES:

At the Alaska Department of Labor and Workforce Development, our goal is putting Alaskans to work. This pamphlet is designed to help contractors awarded public construction contracts understand the most significant laws of the State of Alaska pertaining to prevailing wage.

This pamphlet identifies current prevailing wage rates for public construction contracts (any construction projects awarded for the State of Alaska or its political subdivisions, such as local governments and certain non-profit organizations). Because these rates may change in a subsequent determination, please be sure you are using the appropriate rates. The rates published in this edition become effective September 1, 2020.

The prevailing wage rates contained in this pamphlet are applicable to public construction projects with a final bid date of September 11, 2020, or later. As the law now provides, these rates will remain stable during the life of a contract or for 24 calendar months, whichever is shorter. **The 24-month period begins on the date the prime contract is awarded.** Upon expiration of the initial 24-month period, the latest wage rates issued by the department shall become effective for a subsequent 24-month period or until the original contract is completed, whichever occurs first. This process shall be repeated until the original contract is completed.

The term "original contract" means the signed contract that resulted from the original bid and any amendments, including changes of work scope, additions, extensions, change orders, and other instruments agreed to by the parties that have not been subject to subsequent open bid procedures.

If a higher federal rate is required due to partial federal funding or other federal participation, the higher rate must be paid.

For additional copies of this pamphlet go to: <http://labor.state.ak.us/lss/pamp600.htm>

For questions regarding prevailing wage or employment preference requirements, please contact the nearest Wage and Hour office. These offices are listed on Page x.

Sincerely,

A handwritten signature in black ink that reads "Tamika L. Ledbetter".

Dr. Tamika L. Ledbetter
Commissioner

- This page intentionally left blank -

Table of Contents

Excerpts from Alaska Law

Sec. 36.05.005. Applicability.....	iv
Sec. 36.05.010. Wage rates on public construction.	iv
Sec. 36.05.040. Filing schedule of employees, wages paid and other information	iv
Sec. 36.05.045. Notice of work and completion; withholding of payment	iv
Sec. 36.05.060. Penalty for violation of this chapter	v
Sec. 36.05.070. Wage rates in specifications and contracts for public works	v
Sec. 36.05.080. Failure to pay agreed wages.....	v
Sec. 36.05.090. Payment of wages from withheld payments and listing contractors who violate contracts	v
Sec. 36.05.900. Definition.. ..	vi

Excerpts from Alaska Administrative Code

8 AAC 30.051. Purpose	vi
8 AAC 30.052. Board and lodging; remote sites	vi
8 AAC 30.054. Per diem instead of board and lodging	vi
8 AAC 30.056. Alternative arrangement	vii
8 AAC 30.900. General definitions (selected excerpts).....	vii

Additional Information

Per Diem	vii
Laborer Classification Clarification.....	viii
Apprentice Rates.....	viii
Fringe Benefit Plans.....	viii
Special Prevailing Wage Rate Determination.....	ix
Alaska Employment Preference Information.....	ix
Labor Standards and Safety Notice Requests	x
Debarment List	x

Wage Rates Pages 1-26

Note to Readers: The statutes and administrative regulations listed in this publication were taken from the official codes, as of the effective date of the publication. However, there may be errors or omissions that have not been identified and changes that occurred after the publication was printed. This publication is intended as an informational guide only and is not intended to serve as a precise statement of the statutes and regulations of the State of Alaska. To be certain of current laws and regulations, please refer to the official codes.

EXCERPTS FROM ALASKA LAW

Sec. 36.05.005. Applicability.

This chapter applies only to a public construction contract that exceeds \$25,000.

Sec. 36.05.010. Wage rates on public construction.

A contractor or subcontractor who performs work on a public construction contract in the state shall pay not less than the current prevailing rate of wages for work of a similar nature in the region in which the work is done. The current prevailing rate of wages is that contained in the latest determination of prevailing rate of wages issued by the Department of Labor and Workforce Development at least 10 days before the final date for submission of bids for the contract. The rate shall remain in effect for the life of the contract or for 24 calendar months, whichever is shorter. At the end of the initial 24-month period, if new wage determinations have been issued by the department, the latest wage determination shall become effective for the next 24-month period or until the contract is completed, whichever occurs first. This process shall be repeated until the contract is completed.

Sec. 36.05.040. Filing schedule of employees, wages paid, and other information.

All contractors or subcontractors who perform work on a public construction contract for the state or for a political subdivision of the state shall, before the Friday of every second week, file with the Department of Labor and Workforce Development a sworn affidavit for the previous reporting period, setting out in detail the number of persons employed, wages paid, job classification of each employee, hours worked each day and week, and other information on a form provided by the Department of Labor and Workforce Development.

Sec. 36.05.045. Notice of work and completion; withholding of payment.

- (a) Before commencing work on a public construction contract, the person entering into the contract with a contracting agency shall designate a primary contractor for purposes of this section. Before work commences, the primary contractor shall file a notice of work with the Department of Labor and Workforce Development. The notice of work must list work to be performed under the public construction contract by each contractor who will perform any portion of work on the contract and the contract price being paid to each contractor. The primary contractor shall pay all filing fees for each contractor performing work on the contract, including a filing fee based on the contract price being paid for work performed by the primary contractor's employees. The filing fee payable shall be the sum of all fees calculated for each contractor. The filing fee shall be one percent of each contractor's contract price. The total filing fee payable by the primary contractor under this subsection may not exceed \$5,000. In this subsection, "contractor" means an employer who is using employees to perform work on the public construction contract under the contract or a subcontract.
- (b) Upon completion of all work on the public construction contract, the primary contractor shall file with the Department of Labor and Workforce Development a notice of completion together with payment of any additional filing fees owed due to increased contract amounts. Within 30 days after the department's receipt of the primary contractor's notice of completion, the department shall inform the contracting agency of the amount, if any, to be withheld from the final payment.
- (c) A contracting agency
 - (1) may release final payment of a public construction contract to the extent that the agency has received verification from the Department of Labor and Workforce Development that
 - (A) the primary contractor has complied with (a) and (b) of this section;
 - (B) the Department of Labor and Workforce Development is not conducting an investigation under this title; and
 - (C) the Department of Labor and Workforce Development has not issued a notice of a violation of this chapter to the primary contractor or any other contractors working on the public construction contract; and

- (2) shall withhold from the final payment an amount sufficient to pay the department's estimate of what may be needed to compensate the employees of any contractors under investigation on this construction contract, and any unpaid filing fees.
- (d) The notice and filing fee required under (a) of this section may be filed after work has begun if
 - (1) The public construction contract is for work undertaken in immediate response to an emergency; and
 - (2) The notice and fees are filed not later than 14 days after the work has begun.
- (e) A false statement made on a notice required by this section is punishable under AS 11.56.210.

Sec. 36.05.060. Penalty for violation of this chapter.

A contractor who violates this chapter is guilty of a misdemeanor and upon conviction is punishable by a fine of not less than \$100 nor more than \$1,000, or by imprisonment for not less than 10 days nor more than 90 days, or by both. Each day a violation exists constitutes a separate offense.

Sec. 36.05.070. Wage rates in specifications and contracts for public works.

- (a) The advertised specifications for a public construction contract that requires or involves the employment of mechanics, laborers, or field surveyors must contain a provision stating the minimum wages to be paid various classes of laborers, mechanics, or field surveyors and that the rate of wages shall be adjusted to the wage rate under AS 36.05.010.
- (b) Repealed by §17 ch 142 SLA 1972.
- (c) A public construction contract under (a) of this section must contain provisions that
 - (1) the contractor or subcontractors of the contractor shall pay all employees unconditionally and not less than once a week;
 - (2) wages may not be less than those stated in the advertised specifications, regardless of the contractual relationship between the contractor or subcontractors and laborers, mechanics, or field surveyors;
 - (3) the scale of wages to be paid shall be posted by the contractor in a prominent and easily accessible place at the site of the work;
 - (4) the state or a political subdivision shall withhold so much of the accrued payments as is necessary to pay to laborers, mechanics, or field surveyors employed by the contractor or subcontractors the difference between
 - (A) the rates of wages required by the contract to be paid laborers, mechanics, or field surveyors on the work; and
 - (B) the rates of wages in fact received by laborers, mechanics, or field surveyors.

Sec. 36.05.080. Failure to pay agreed wages.

Every contract within the scope of AS 36.05.070 shall contain a provision that if it is found that a laborer, mechanic, or field surveyor employed by the contractor or subcontractor has been or is being paid a rate of wages less than the rate of wages required by the contract to be paid, the state or its political subdivision may, by written notice to the contractor, terminate the contractor's right to proceed with the work or the part of the work for which there is a failure to pay the required wages and to prosecute the work to completion by contract or otherwise, and the contractor and the contractor's sureties are liable to the state or its political subdivision for excess costs for completing the work.

Sec. 36.05.090. Payment of wages from withheld payments and listing contractors who violate contracts.

- (a) The state disbursing officer in the case of a state public construction contract and the local fiscal officer in the case of a political subdivision public construction contract shall pay directly to laborers, mechanics, or field surveyors from accrued payments withheld under the terms of the contract the wages due laborers, mechanics, or field surveyors under AS 36.05.070.
- (b) The state disbursing officer or the local fiscal officer shall distribute to all departments of the state government and to all political subdivisions of the state a list giving the names of persons who have disregarded their obligations to employees. A person appearing on this list and a firm, corporation, partnership, or association in which the person has an interest may not work as a contractor or

subcontractor on a public construction contract for the state or a political subdivision of the state until three years after the date of publication of the list. If the accrued payments withheld under the contract are insufficient to reimburse all the laborers, mechanics, or field surveyors with respect to whom there has been a failure to pay the wages required under AS 36.05.070, the laborers, mechanics, or field surveyors have the right of action or intervention or both against the contractor and the contractor's sureties conferred by law upon persons furnishing labor or materials, and in the proceedings it is not a defense that the laborers, mechanics, or field surveyors accepted or agreed to accept less than the required rate of wages or voluntarily made refunds.

Sec. 36.05.900. Definition.

In this chapter, "contracting agency" means the state or a political subdivision of the state that has entered into a public construction contract with a contractor.

EXCERPTS FROM ALASKA ADMINISTRATIVE CODE

*****Notice:** Regulations relating to board and lodging and per diem went into effect on November 25, 2018. The new regulations are excerpted here***

8 AAC 30.051. Purpose. The purpose of 8 AAC 30.052 – 8 AAC 30.056 is to ensure that wages paid to laborers, mechanics, and field surveyors do not fall below the prevailing rate of pay.

8 AAC 30.052. Board and lodging; remote sites. (a) A contractor on a public construction project located 65 or more road miles from the international airport closest to the project area in either Fairbanks, Juneau, or Anchorage, or that is inaccessible by road in a two-wheel drive vehicle, shall provide adequate board and lodging to each laborer, mechanic, or field surveyor while the person is employed on the project. If commercial lodging facilities are not available, the contractor shall provide temporary lodging facilities. Lodging facilities must comply with all applicable state and federal laws. For a highway project, the location of the project is measured from the midpoint of the project.

(b) A contractor is not required to provide board and lodging:

(1) to a laborer, mechanic, or field surveyor who is a domiciled resident of the project area; or

(2) on a laborer, mechanic, or field surveyor's scheduled days off, when the person can reasonably travel between the project and the person's permanent residence; for the purposes of this paragraph, "scheduled day off" means a day in which a person does not perform work on-site, is not required to remain at or near the job location for the benefit of the contractor, and is informed of the day off at least seven days before the day off.

(c) Upon a contractor's written request, the commissioner may waive the requirements of (a) of this section where:

(1) the project is inaccessible by road in a two-wheel drive vehicle, but the laborer, mechanic, or field surveyor can reasonably travel between the project and the person's permanent residence within one hour; or

(2) a laborer, mechanic, or field surveyor is not a domiciled resident of the project area, but has established permanent residence, with the intent to remain indefinitely, within 65 road miles of the project, or for a highway project, the mid-point of the project.

8 AAC 30.054. Per diem instead of board and lodging. (a) A contractor may pay a laborer, mechanic, or field surveyor per diem instead of providing board and lodging, when the following conditions are met:

(1) the department determines that per diem instead of board and lodging is an established practice for the work classification; the department shall publish and periodically revise its determinations in the pamphlet *Laborers' and Mechanics' Minimum Rates of Pay*;

(2) the contractor pays each laborer, mechanic, or field surveyor the appropriate per diem rate as published and periodically revised in the pamphlet *Laborers' and Mechanics' Minimum Rates of Pay*; and

(3) the contractor pays the per diem to each laborer, mechanic, or field surveyor on the same day that wages are paid.

(b) A contractor may not pay per diem instead of board and lodging on a highway project located

- (1) west of Livengood on the Elliot Highway, AK-2;
- (2) on the Dalton Highway, AK-11;
- (3) north of milepost 20 on the Taylor Highway, AK-5;
- (4) east of Chicken on the Top of the World Highway; or
- (5) south of Tetlin Junction to the Alaska-Canada border on the Alaska Highway, AK-2.

8 AAC 30.056. Alternative arrangement. Upon a contractor’s written request, the commissioner may approve an alternative board and lodging or per diem arrangement, provided

- (1) the arrangement does not reduce the laborer, mechanic, or field surveyor’s wages below the prevailing wage rate; and
- (2) the laborer, mechanic, or field surveyor voluntarily enters into and signs the written arrangement; a labor organization representing laborers, mechanics, or field surveyors may enter into the written agreement on their behalf.

8 AAC 30.900. General definitions (selected excerpts only):

In this chapter and in AS 36

(22) “domiciled resident” means a person living within 65 road miles of a public construction project, or in the case of a highway project, the mid-point of the project, for at least 12 consecutive months prior to the award of the public construction project;

(23) “employed on the project” means the time period from the date the laborer, mechanic, or field surveyor first reports on-site to the project through the final date the person reports on-site to the project.

ADDITIONAL INFORMATION

PER DIEM

Notice: New regulations relating to board and lodging and per diem went into effect on November 25, 2018. The regulations provide a comprehensive set of requirements for the provision of board and lodging or per diem for workers on remote projects. Please refer to Alaska Administrative Code 8 AAC Chapter 30 and read the chapter carefully.

The Alaska Department of Labor and Workforce Development has determined that per diem is an established work practice for certain work classifications. These classifications are indicated throughout the Pamphlet by an asterisk (*) under the classification title. If all of the conditions of 8 AAC 30.054 are met, an employer may pay workers in these classifications per diem instead of providing board and lodging on a remote project.

Per Diem Rate: As of May 1st, 2019, the minimum per diem rate is \$100.00 per day, or part thereof, the worker is employed on the project. In the event that a contractor provides lodging facilities, but no meals, the department will accept a payment of \$48 per day for meals to meet the per diem requirements.

LABORER CLASSIFICATION CLARIFICATION

The laborer rates categorized in class code S1201-S1206 apply in one area of Alaska; the area that is south of N63 latitude and west of W138 Longitude. The laborer rates categorized in class code N1201-N1206 apply in two areas of Alaska; the Alaska areas north of N63 latitude and east of W138 longitude. The following graphic representations should assist with clarifying the applicable wage rate categories:

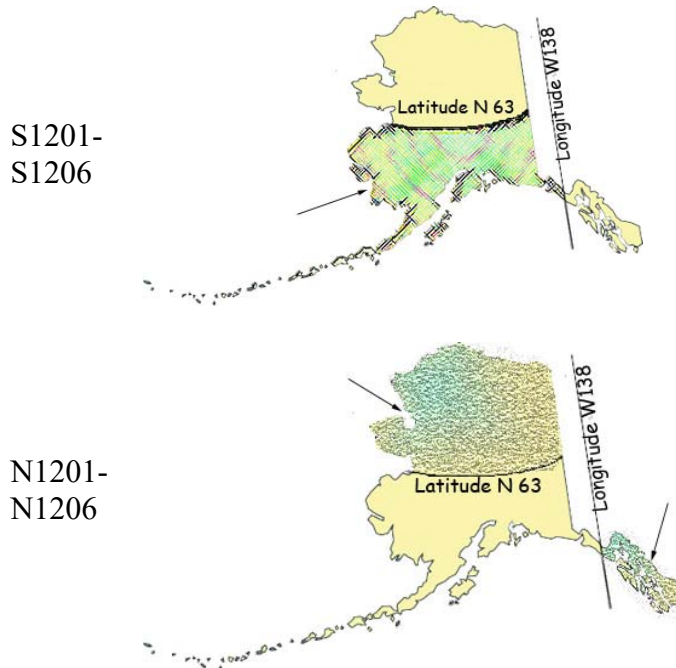

APPRENTICE RATES

Apprentice rates at less than the minimum prevailing rates may be paid to apprentices according to an apprentice program which has been registered and approved by the Commissioner of the Alaska Department of Labor and Workforce Development in writing or according to a bona fide apprenticeship program registered with the U.S. Department of Labor, Office of Apprenticeship Training. **Any employee listed on a payroll at an apprentice wage rate who is not registered as above shall be paid the journeyman prevailing minimum wage in that work classification.** Wage rates are based on prevailing crew makeup practices in Alaska and apply to work performed regardless of either the quality of the work performed by the employee or the titles or classifications which may be assigned to individual employees.

FRINGE BENEFIT PLANS

Contractors/subcontractors may compensate fringe benefits to their employees in any one of three methods. The fringe benefits may be paid into a union trust fund, into an approved benefit plan, or paid directly on the paycheck as gross wages.

Where fringe benefits are paid into approved plans, funds, or programs including union trust funds, the payments must be contributed at least monthly. If contractors submit their own payroll forms and are paying fringe benefits into approved plans, funds, or programs, the employer's certification must include, in addition to those requirements of 8 AAC 30.020(c), a statement that fringe benefit payments have been or will be paid at least monthly. Contractors who pay fringe benefits to a plan must ensure the plan is one approved by the Internal Revenue Service and that the plan meets the requirements of 8 AAC 30.025 (eff. 3/2/08) in order for payments to be credited toward the prevailing wage obligation.

SPECIAL PREVAILING WAGE RATE DETERMINATION

Special prevailing wage rate determinations may be requested for special projects or a special worker classification if the work to be performed does not conform to traditional public construction for which a prevailing wage rate has been established under 8 AAC 30.050(a) of this section. Requests for special wage rate determinations must be in writing and filed with the Commissioner at least 30 days before the award of the contract. An applicant for a special wage rate determination shall have the responsibility to support the necessity for the special rate. An application for a special wage rate determination filed under this section must contain:

- (1) a specification of the contract or project on which the special rates will apply and a description of the work to be performed;
- (2) a brief narrative explaining why special wage rates are necessary;
- (3) the job class or classes involved;
- (4) the special wage rates the applicant is requesting, including survey or other relevant wage data to support the requested rates;
- (5) the approximate number of employees who would be affected; and
- (6) any other information which might be helpful in determining if special wage rates are appropriate.

Requests made pursuant to the above should be addressed to:

Director
Alaska Department of Labor and Workforce Development
Labor Standards and Safety Division
Wage and Hour Administration
P.O. Box 111149
Juneau, AK 99811-1149

-or-

Email: statewide.wagehour@alaska.gov

EMPLOYMENT PREFERENCE INFORMATION

In October 2019, the Alaska Attorney General issued a formal opinion stating that the Alaska Statutes 36.10.150 of the State’s 90% Employment Preference law, also known as the Alaska Resident Hire law, violates both the U.S. and Alaska Constitutions. As a result, the state has stopped all enforcement activity.

A copy of the Attorney General opinion is found here:

http://law.alaska.gov/pdf/opinions/opinions_2019/19-005_AK-hire.pdf

Alaska Department of Labor and Workforce Development
Labor Standards and Safety Division
Wage and Hour Administration
Web site: <http://labor.state.ak.us/lss/pamp600.htm>

Anchorage

1251 Muldoon Road, Suite 113
Anchorage, Alaska 99504-2098
Phone: (907) 269-4900

Email:
statewide.wagehour@alaska.gov

Juneau

PO Box 111149
Juneau, Alaska 99811
Phone: (907) 465-4842

Email:
statewide.wagehour@alaska.gov

Fairbanks

Regional State Office Building
675 7th Ave., Station J-1
Fairbanks, Alaska 99701-4593
Phone: (907) 451-2886

Email:
statewide.wagehour@alaska.gov

LABOR STANDARDS AND SAFETY NOTICE REQUESTS

If you would like to receive Wage and Hour Administration or Mechanical Inspection **regulation notices** or **publications information**, they are available via electronic mail, by signing up in the GovDelivery System, <https://public.govdelivery.com/accounts/AKDOL/subscriber/new> and selecting topics *LSS – Wage and Hour – Forms and Publications*, *LSS – Mechanical Inspection Regulations*, or *LSS – Wage and Hour Regulations*.

Publications are also available online at <http://labor.alaska.gov/lss/home.htm>

DEBARMENT LIST

AS 36.05.090(b) states that “the state disbursing officer or the local fiscal officer shall distribute to all departments of the state government and to all political subdivisions of the state a list giving the names of persons who have disregarded their obligations to employees.”

A person appearing on the following debarment list and a firm, corporation, partnership, or association in which the person has an interest may not work as a contractor or subcontractor on a public construction contract for the state or a political subdivision of the state for three years from the date of debarment.

Company Name

Debarment Expires

Tim Banach, Individual
Boulder Creek Electric

February 23, 2021
February 23, 2021

Laborers' & Mechanics' Minimum Rates of Pay

Class Code	Classification of Laborers & Mechanics	BHR	H&W	PEN	TRN	Other	Benefits	THR
------------	--	-----	-----	-----	-----	-------	----------	-----

Boilermakers

*See per diem note on last page

A0101	Boilermaker (journeyman)	46.08	8.57	16.72	1.65	VAC	SAF	76.86
						3.50	0.34	

Bricklayers & Blocklayers

*See per diem note on last page

A0201	Blocklayer	42.16	9.00	10.05	0.62	L&M		62.03
						0.20		

Bricklayer
 Marble or Stone Mason
 Refractory Worker (Firebrick, Plastic, Castable, and Gunitite Refractory Applications)
 Terrazzo Worker
 Tile Setter

A0202	Tuck Pointer Caulker	42.16	9.00	10.05	0.62	L&M		62.03
						0.20		

Cleaner (PCC)

A0203	Marble & Tile Finisher	35.99	9.00	10.05	0.62	L&M		55.86
						0.20		

Terrazzo Finisher

A0204	Torginal Applicator	40.10	9.83	8.50	0.55	L&M	0.87	60.00
						0.15		

Carpenters, Region I (North of 63 latitude)

*See per diem note on last page

N0301	Carpenter (journeyman)	38.34	10.08	15.23	1.10	L&M	SAF	64.95
						0.10	0.10	

Lather/Drywall/Acoustical

Carpenters, Region II (South of N63 latitude)

*See per diem note on last page

S0301	Carpenter (journeyman)	38.34	10.08	15.77	1.10	L&M	SAF	65.49
						0.10	0.10	

Lather/Drywall/Acoustical

Cement Masons

*See per diem note on last page

Wage benefits key: BHR=basic hourly rate; H&W=health and welfare; IAF=industry advancement fund; LEG=legal fund; L&M=labor/management fund; PEN=pens fund; SAF=safety; SUI=supplemental unemployment insurance; S&L=SUI & LEG combined; TRN=training; THR=total hourly rate; VAC=vacation

Cement Masons								
*See per diem note on last page								

							L&M	
A0401	Group I, including:	38.38	8.70	11.80	1.43	0.10		60.41
	Application of Sealing Compound							
	Application of Underlayment							
	Building, General							
	Cement Mason (journeyman)							
	Concrete							
	Concrete Paving							
	Curb & Gutter, Sidewalk							
	Curing of All Concrete							
	Grouting & Caulking of Tilt-Up Panels							
	Grouting of All Plates							
	Patching Concrete							
	Screed Pin Setter							
	Spackling/Skim Coating							

A0402	Group II, including:	38.38	8.70	11.80	1.43	0.10	L&M	60.41
	Form Setter							

A0403	Group III, including:	38.38	8.70	11.80	1.43	0.10	L&M	60.41
	Concrete Saw (self-powered)							
	Curb & Gutter Machine							
	Floor Grinder							
	Pneumatic Power Tools							
	Power Chipping & Bushing							
	Sand Blasting Architectural Finish							
	Screed & Rodding Machine Operator							
	Troweling Machine Operator							

A0404	Group IV, including:	38.38	8.70	11.80	1.43	0.10	L&M	60.41
	Application of All Composition Mastic							
	Application of All Epoxy Material							
	Application of All Plastic Material							
	Finish Colored Concrete							
	Guniting Nozzleman							
	Hand Powered Grinder							
	Tunnel Worker							

A0405	Group V, including:	38.38	8.70	11.80	1.43	0.10	L&M	60.41
	Plasterer							

Wage benefits key: BHR=basic hourly rate; H&W=health and welfare; IAF=industry advancement fund; LEG=legal fund; L&M=labor/management fund; PEN=pens fund; SAF=safety; SUI=supplemental unemployment insurance; S&L=SUI & LEG combined; TRN=training; THR=total hourly rate; VAC=vacation

Class Code	Classification of Laborers & Mechanics	BHR	H&W	PEN	TRN	Other	Benefits	THR
------------	--	-----	-----	-----	-----	-------	----------	-----

Culinary Workers

A0501	Baker/Cook	28.37	8.40	7.56			LEG	44.33
A0503	General Helper	25.05	8.40	7.56			LEG	41.01
	Housekeeper							
	Janitor							
	Kitchen Helper							
A0504	Head Cook	28.97	8.40	7.56			LEG	44.93
A0505	Head Housekeeper	25.45	8.40	7.56			LEG	41.41
	Head Kitchen Help							

Dredgemen
*See per diem note on last page

A0601	Assistant Engineer	40.76	10.35	13.00	1.00		L&M	65.26
	Craneman							
	Electrical Generator Operator (primary pump/power barge/dredge)							
	Engineer							
	Welder							
A0602	Assistant Mate (deckhand)	39.60	10.35	13.00	1.00		L&M	64.10
A0603	Fireman	40.04	10.35	13.00	1.00		L&M	64.54
A0605	Leverman Clamshell	43.29	10.35	13.00	1.00		L&M	67.79
A0606	Leverman Hydraulic	41.53	10.35	13.00	1.00		L&M	66.03
A0607	Mate & Boatman	40.76	10.35	13.00	1.00		L&M	65.26
A0608	Oiler (dredge)	40.04	10.35	13.00	1.00		L&M	64.54

Electricians
*See per diem note on last page

A0701	Inside Cable Splicer	41.27	13.90	13.88	0.95		L&M	LEG	70.35
--------------	----------------------	-------	-------	-------	------	--	----------------	------------	-------

Wage benefits key: BHR=basic hourly rate; H&W=health and welfare; IAF=industry advancement fund; LEG=legal fund; L&M=labor/management fund; PEN=pens fund; SAF=safety; SUI=supplemental unemployment insurance; S&L=SUI & LEG combined; TRN=training; THR=total hourly rate; VAC=vacation

Class Code	Classification of Laborers & Mechanics	BHR	H&W	PEN	TRN	Other	Benefits	THR
------------	--	-----	-----	-----	-----	-------	----------	-----

Electricians

*See per diem note on last page

A0702	Inside Journeyman Wireman, including: Technicians (including use of drones in electrical construction)	40.94	13.90	14.12	0.95		L&M 0.20	LEG 0.15	70.26
A0703	Power Cable Splicer	57.79	13.90	18.92	0.95		L&M 0.20	LEG 0.15	91.91
A0704	Tele Com Cable Splicer	50.53	13.90	16.17	0.95		L&M 0.20	LEG 0.15	81.90
A0705	Power Journeyman Lineman, including: Power Equipment Operator Technician (including use of drones in electrical construction)	56.04	13.90	18.87	0.95		L&M 0.20	LEG 0.15	90.11
A0706	Tele Com Journeyman Lineman, including: Technician (including use of drones in telecommunications construction) Tele Com Equipment Operator	48.78	13.90	16.11	0.95		L&M 0.20	LEG 0.15	80.09
A0707	Straight Line Installer - Repairman	48.78	13.90	16.11	0.95		L&M 0.20	LEG 0.15	80.09
A0708	Powderman	54.04	13.90	18.81	0.95		L&M 0.20	LEG 0.15	88.05
A0710	Material Handler	26.57	13.33	4.80	0.15		L&M 0.15	LEG 0.15	45.15
A0712	Tree Trimmer Groundman	28.37	13.90	12.59	0.15		L&M 0.15	LEG 0.15	55.31
A0713	Journeyman Tree Trimmer	37.30	13.90	12.86	0.15		L&M 0.15	LEG 0.15	64.51
A0714	Vegetation Control Sprayer	40.85	13.90	12.97	0.15		L&M 0.15	LEG 0.15	68.17
A0715	Inside Journeyman Communications CO/PBX	39.52	13.90	13.83	0.95		L&M 0.20	LEG 0.15	68.55

Elevator Workers

*See per diem note on last page

A0802	Elevator Constructor	41.38	15.73	18.41	0.63		L&M 0.48	VAC 4.59	81.22
A0803	Elevator Constructor Mechanic	59.11	15.73	18.41	0.63		L&M 0.48	VAC 6.56	100.92

Wage benefits key: BHR=basic hourly rate; H&W=health and welfare; IAF=industry advancement fund; LEG=legal fund; L&M=labor/management fund; PEN=pens fund; SAF=safety; SUI=supplemental unemployment insurance; S&L=SUI & LEG combined; TRN=training; THR=total hourly rate; VAC=vacation

Class Code	Classification of Laborers & Mechanics	BHR	H&W	PEN	TRN	Other	Benefits	THR
Heat & Frost Insulators/Asbestos Workers								
*See per diem note on last page								
A0902	Asbestos Abatement-Mechanical Systems	38.68	9.24	11.01	1.20	0.12	SAF	60.25
A0903	Asbestos Abatement/General Demolition All Systems	38.68	9.24	11.01	1.20	0.12	SAF	60.25
A0904	Insulator, Group II	38.68	9.24	11.01	1.20	0.12	SAF	60.25
A0905	Fire Stop	38.68	9.24	11.01	1.20	0.12	SAF	60.25
IronWorkers								
*See per diem note on last page								
A1101	Ironworkers, including:	38.87	9.51	24.28	0.74	0.20	L&M IAF	73.84
	Bender Operators							
	Bridge & Structural							
	Hangar Doors							
	Hollow Metal Doors							
	Industrial Doors							
	Machinery Mover							
	Ornamental							
	Reinforcing							
	Rigger							
	Sheeter							
	Signalman							
	Stage Rigger							
	Toxic Haz-Mat Work							
	Welder							
A1102	Helicopter	39.87	9.51	24.28	0.74	0.20	L&M IAF	74.84
	Helicopter (used for rigging and setting)							
	Tower (energy producing windmill type towers to include nacelle and blades)							
A1103	Fence/Barrier Installer	35.37	9.51	23.93	0.74	0.20	L&M IAF	69.99
A1104	Guard Rail Layout Man	36.11	9.51	23.93	0.74	0.20	L&M IAF	70.73
A1105	Guard Rail Installer	36.37	9.51	23.93	0.74	0.20	L&M IAF	70.99

Wage benefits key: BHR=basic hourly rate; H&W=health and welfare; IAF=industry advancement fund; LEG=legal fund; L&M=labor/management fund; PEN=pens fund; SAF=safety; SUI=supplemental unemployment insurance; S&L=SUI & LEG combined; TRN=training; THR=total hourly rate; VAC=vacation

Laborers (The Alaska areas north of N63 latitude and east of W138 longitude)

*See per diem note on last page

						L&M	LEG	
N1201	Group I, including:	31.71	8.95	17.81	1.30	0.20	0.20	60.17
	Asphalt Worker (shovelman, plant crew)							
	Brush Cutter							
	Camp Maintenance Laborer							
	Carpenter Tender or Helper							
	Choke Setter, Hook Tender, Rigger, Signalman							
	Concrete Labor (curb & gutter, chute handler, curing, grouting, screeding)							
	Crusher Plant Laborer							
	Demolition Laborer							
	Ditch Digger							
	Dumpman							
	Environmental Laborer (hazard/toxic waste, oil spill)							
	Fence Installer							
	Fire Watch Laborer							
	Flagman							
	Form Stripper							
	General Laborer							
	Guardrail Laborer, Bridge Rail Installer							
	Hydro-seeder Nozzleman							
	Laborer, Building							
	Landscaper or Planter							
	Laying of Mortarless Decorative Block (retaining walls, flowered decorative block 4 feet or less - highway or landscape work)							
	Material Handler							
	Pneumatic or Power Tools							
	Portable or Chemical Toilet Serviceman							
	Pump Man or Mixer Man							
	Railroad Track Laborer							
	Sandblast, Pot Tender							
	Saw Tender							
	Slurry Work							
	Steam Cleaner Operator							
	Steam Point or Water Jet Operator							
	Storm Water Pollution Protection Plan Worker (SWPPP Worker - erosion and sediment control Laborer)							
	Tank Cleaning							
	Utiliwalk & Utilidor Laborer							
	Watchman (construction projects)							
	Window Cleaner							

Wage benefits key: BHR=basic hourly rate; H&W=health and welfare; IAF=industry advancement fund; LEG=legal fund; L&M=labor/management fund; PEN=pens fund; SAF=safety; SUI=supplemental unemployment insurance; S&L=SUI & LEG combined; TRN=training; THR=total hourly rate; VAC=vacation

Laborers (The Alaska areas north of N63 latitude and east of W138 longitude)

*See per diem note on last page

						L&M	LEG	
N1202	Group II, including:	32.71	8.95	17.81	1.30	0.20	0.20	61.17
	Burning & Cutting Torch							
	Cement or Lime Dumper or Handler (sack or bulk)							
	Certified Erosion Sediment Control Lead (CESCL Laborer)							
	Choker Splicer							
	Chucktender (wagon, air-track & hydraulic drills)							
	Concrete Laborer (power buggy, concrete saws, pumpcrete nozzleman, vibratorman)							
	Culvert Pipe Laborer							
	Cured Inplace Pipelayer							
	Environmental Laborer (asbestos, marine work)							
	Floor Preparation, Core Drilling							
	Foam Gun or Foam Machine Operator							
	Green Cutter (dam work)							
	Gunite Operator							
	Hod Carrier							
	Jackhammer/Chipping Gun or Pavement Breaker							
	Laser Instrument Operator							
	Laying of Mortarless Decorative Block (retaining walls, flowered decorative block over 4 feet - highway or landscape work)							
	Mason Tender & Mud Mixer (sewer work)							
	Pilot Car							
	Pipelayer Helper							
	Plasterer, Bricklayer & Cement Finisher Tender							
	Powderman Helper							
	Power Saw Operator							
	Railroad Switch Layout Laborer							
	Sandblaster							
	Scaffold Building & Erecting							
	Sewer Caulker							
	Sewer Plant Maintenance Man							
	Thermal Plastic Applicator							
	Timber Faller, Chainsaw Operator, Filer							
	Timberman							

						L&M	LEG	
N1203	Group III, including:	33.61	8.95	17.81	1.30	0.20	0.20	62.07

- Bit Grinder
- Camera/Tool/Video Operator
- Guardrail Machine Operator
- High Rigger & Tree Topper
- High Scaler

Wage benefits key: BHR=basic hourly rate; H&W=health and welfare; IAF=industry advancement fund; LEG=legal fund; L&M=labor/management fund; PEN=pens fund; SAF=safety; SUI=supplemental unemployment insurance; S&L=SUI & LEG combined; TRN=training; THR=total hourly rate; VAC=vacation

Laborers (The Alaska areas north of N63 latitude and east of W138 longitude)

*See per diem note on last page

						L&M	LEG	
N1203	Group III, including:	33.61	8.95	17.81	1.30	0.20	0.20	62.07

- Multiplate
- Plastic Welding
- Slurry Seal Squeegee Man
- Traffic Control Supervisor
- Welding Certified (in connection with laborer's work)

						L&M	LEG	
N1204	Group IIIA	36.89	8.95	17.81	1.30	0.20	0.20	65.35

- Asphalt Raker, Asphalt Belly Dump Lay Down
- Drill Doctor (in the field)
- Driller (including, but not limited to wagon drills, air-track drills, hydraulic drills)
- Pioneer Drilling & Drilling Off Tugger (all type drills)
- Pipelayers
- Powderman (Employee Possessor)
- Storm Water Pollution Protection Plan Specialist (SWPPP Specialist)
- Traffic Control Supervisor, DOT Qualified

						L&M	LEG	
N1205	Group IV	21.28	8.95	17.81	1.30	0.20	0.20	49.74

- Final Building Cleanup
- Permanent Yard Worker

						L&M	LEG	
N1206	Group IIIB	40.68	6.24	17.81	1.30	0.20	0.20	66.43

- Driller (including, but not limited to wagon drills, air-track drills, hydraulic drills)(over 5,000 hours)
- Federal Powderman (Responsible Person in Charge)
- Grade Checking (setting or transferring of grade marks, line and grade, GPS, drones)
- Pioneer Drilling & Drilling Off Tugger (all type drills)(over 5,000 hours)
- Stake Hopper

Laborers (The area that is south of N63 latitude and west of W138 longitude)

*See per diem note on last page

						L&M	LEG	
S1201	Group I, including:	31.71	8.95	17.81	1.30	0.20	0.20	60.17

- Asphalt Worker (shovelman, plant crew)
- Brush Cutter
- Camp Maintenance Laborer
- Carpenter Tender or Helper

Wage benefits key: BHR=basic hourly rate; H&W=health and welfare; IAF=industry advancement fund; LEG=legal fund; L&M=labor/management fund; PEN=pens fund; SAF=safety; SUI=supplemental unemployment insurance; S&L=SUI & LEG combined; TRN=training; THR=total hourly rate; VAC=vacation

Laborers (The area that is south of N63 latitude and west of W138 longitude)

*See per diem note on last page

						L&M	LEG	
S1201	Group I, including:	31.71	8.95	17.81	1.30	0.20	0.20	60.17
	Choke Setter, Hook Tender, Rigger, Signalman							
	Concrete Labor (curb & gutter, chute handler, curing, grouting, screeding)							
	Crusher Plant Laborer							
	Demolition Laborer							
	Ditch Digger							
	Dumpman							
	Environmental Laborer (hazard/toxic waste, oil spill)							
	Fence Installer							
	Fire Watch Laborer							
	Flagman							
	Form Stripper							
	General Laborer							
	Guardrail Laborer, Bridge Rail Installer							
	Hydro-seeder Nozzleman							
	Laborer, Building							
	Landscaper or Planter							
	Laying of Mortarless Decorative Block (retaining walls, flowered decorative block 4 feet or less - highway or landscape work)							
	Material Handler							
	Pneumatic or Power Tools							
	Portable or Chemical Toilet Serviceman							
	Pump Man or Mixer Man							
	Railroad Track Laborer							
	Sandblast, Pot Tender							
	Saw Tender							
	Slurry Work							
	Steam Cleaner Operator							
	Steam Point or Water Jet Operator							
	Storm Water Pollution Protection Plan Worker (SWPPP Worker - erosion and sediment control Laborer)							
	Tank Cleaning							
	Utiliwalk & Utilidor Laborer							
	Watchman (construction projects)							
	Window Cleaner							
S1202	Group II, including:	32.71	8.95	17.81	1.30	0.20	0.20	61.17
	Burning & Cutting Torch							
	Cement or Lime Dumper or Handler (sack or bulk)							
	Certified Erosion Sediment Control Lead (CESCL Laborer)							

Wage benefits key: BHR=basic hourly rate; H&W=health and welfare; IAF=industry advancement fund; LEG=legal fund; L&M=labor/management fund; PEN=pens fund; SAF=safety; SUI=supplemental unemployment insurance; S&L=SUI & LEG combined; TRN=training; THR=total hourly rate; VAC=vacation

Laborers (The area that is south of N63 latitude and west of W138 longitude)

*See per diem note on last page

						L&M	LEG	
S1202	Group II, including:	32.71	8.95	17.81	1.30	0.20	0.20	61.17

- Choker Splicer
- Chucktender (wagon, air-track & hydraulic drills)
- Concrete Laborer (power buggy, concrete saws, pumpcrete nozzleman, vibratorman)
- Culvert Pipe Laborer
- Cured Inplace Pipelayer
- Environmental Laborer (asbestos, marine work)
- Floor Preparation, Core Drilling
- Foam Gun or Foam Machine Operator
- Green Cutter (dam work)
- Guniting Operator
- Hod Carrier
- Jackhammer/Chipping Gun or Pavement Breaker
- Laser Instrument Operator
- Laying of Mortarless Decorative Block (retaining walls, flowered decorative block over 4 feet - highway or landscape work)
- Mason Tender & Mud Mixer (sewer work)
- Pilot Car
- Pipelayer Helper
- Plasterer, Bricklayer & Cement Finisher Tender
- Powderman Helper
- Power Saw Operator
- Railroad Switch Layout Laborer
- Sandblaster
- Scaffold Building & Erecting
- Sewer Caulker
- Sewer Plant Maintenance Man
- Thermal Plastic Applicator
- Timber Faller, Chainsaw Operator, Filer
- Timberman

						L&M	LEG	
S1203	Group III, including:	33.61	8.95	17.81	1.30	0.20	0.20	62.07

- Bit Grinder
- Camera/Tool/Video Operator
- Guardrail Machine Operator
- High Rigger & Tree Topper
- High Scaler
- Multiplate
- Plastic Welding
- Slurry Seal Squeegee Man

Wage benefits key: BHR=basic hourly rate; H&W=health and welfare; IAF=industry advancement fund; LEG=legal fund; L&M=labor/management fund; PEN=pens fund; SAF=safety; SUI=supplemental unemployment insurance; S&L=SUI & LEG combined; TRN=training; THR=total hourly rate; VAC=vacation

Class Code	Classification of Laborers & Mechanics	BHR	H&W	PEN	TRN	Other	Benefits	THR
------------	--	-----	-----	-----	-----	-------	----------	-----

Laborers (The area that is south of N63 latitude and west of W138 longitude)

*See per diem note on last page

S1203	Group III, including:	33.61	8.95	17.81	1.30		L&M	LEG	62.07
--------------	-----------------------	-------	------	-------	------	--	----------------	------------	-------

Traffic Control Supervisor
Welding Certified (in connection with laborer's work)

S1204	Group IIIA	36.89	8.95	17.81	1.30		L&M	LEG	65.35
--------------	------------	-------	------	-------	------	--	----------------	------------	-------

Asphalt Raker, Asphalt Belly Dump Lay Down
Drill Doctor (in the field)
Driller (including, but not limited to wagon drills, air-track drills, hydraulic drills)
Pioneer Drilling & Drilling Off Tugger (all type drills)
Pipelayers
Powderman (Employee Possessor)
Storm Water Pollution Protection Plan Specialist (SWPPP Specialist)
Traffic Control Supervisor, DOT Qualified

S1205	Group IV	21.28	8.95	17.81	1.30		L&M	LEG	49.74
--------------	----------	-------	------	-------	------	--	----------------	------------	-------

Final Building Cleanup
Permanent Yard Worker

S1206	Group IIIB	40.68	6.24	17.81	1.30		L&M	LEG	66.43
--------------	------------	-------	------	-------	------	--	----------------	------------	-------

Driller (including, but not limited to wagon drills, air-track drills, hydraulic drills)(over 5,000 hours)
Federal Powderman (Responsible Person in Charge)
Grade Checking (setting or transferring of grade marks, line and grade, GPS, drones)
Pioneer Drilling & Drilling Off Tugger (all type drills)(over 5,000 hours)
Stake Hopper

Millwrights

*See per diem note on last page

A1251	Millwright (journeyman)	40.77	10.08	12.28	1.10		L&M	0.05	64.68
--------------	-------------------------	-------	-------	-------	------	--	----------------	------	-------

A1252	Millwright Welder	41.77	10.08	12.28	1.10		L&M	0.05	65.68
--------------	-------------------	-------	-------	-------	------	--	----------------	------	-------

Painters, Region I (North of N63 latitude)

*See per diem note on last page

N1301	Group I, including:	32.99	8.71	13.50	1.08		L&M	0.07	56.35
--------------	---------------------	-------	------	-------	------	--	----------------	------	-------

Wage benefits key: BHR=basic hourly rate; H&W=health and welfare; IAF=industry advancement fund; LEG=legal fund; L&M=labor/management fund; PEN=pens fund; SAF=safety; SUI=supplemental unemployment insurance; S&L=SUI & LEG combined; TRN=training; THR=total hourly rate; VAC=vacation

Painters, Region I (North of N63 latitude)

*See per diem note on last page

N1301	Group I, including:	32.99	8.71	13.50	1.08		L&M 0.07	56.35
--------------	---------------------	-------	------	-------	------	--	------------------------	-------

- Brush
- General Painter
- Hand Taping
- Hazardous Material Handler
- Lead-Based Paint Abatement
- Roll

N1302	Group II, including:	33.51	8.71	13.50	1.08		L&M 0.07	56.87
--------------	----------------------	-------	------	-------	------	--	------------------------	-------

- Bridge Painter
- Epoxy Applicator
- General Drywall Finisher
- Hand/Spray Texturing
- Industrial Coatings Specialist
- Machine/Automatic Taping
- Pot Tender
- Sandblasting
- Specialty Painter
- Spray
- Structural Steel Painter
- Wallpaper/Vinyl Hanger

N1304	Group IV, including:	39.64	8.71	16.37	1.05		0.05	65.82
--------------	----------------------	-------	------	-------	------	--	------	-------

- Glazier
- Storefront/Automatic Door Mechanic

N1305	Group V, including:	28.63	8.71	5.02	0.83		0.07	43.26
--------------	---------------------	-------	------	------	------	--	------	-------

- Carpet Installer
- Floor Coverer
- Heat Weld/Cove Base
- Linoleum/Soft Tile Installer

Painters, Region II (South of N63 latitude)

*See per diem note on last page

S1301	Group I, including :	30.33	8.71	14.15	1.08		L&M 0.07	54.34
--------------	----------------------	-------	------	-------	------	--	------------------------	-------

- Brush
- General Painter
- Hand Taping
- Hazardous Material Handler

Wage benefits key: BHR=basic hourly rate; H&W=health and welfare; IAF=industry advancement fund; LEG=legal fund; L&M=labor/management fund; PEN=pens fund; SAF=safety; SUI=supplemental unemployment insurance; S&L=SUI & LEG combined; TRN=training; THR=total hourly rate; VAC=vacation

Painters, Region II (South of N63 latitude)

*See per diem note on last page

S1301	Group I, including :	30.33	8.71	14.15	1.08		L&M 0.07	54.34
--------------	----------------------	-------	------	-------	------	--	------------------------	-------

- Lead-Based Paint Abatement
- Roll
- Spray

S1302	Group II, including :	31.58	8.71	14.15	1.08		L&M 0.07	55.59
--------------	-----------------------	-------	------	-------	------	--	------------------------	-------

- General Drywall Finisher
- Hand/Spray Texturing
- Machine/Automatic Taping
- Wallpaper/Vinyl Hanger

S1303	Group III, including :	31.68	8.71	14.15	1.08		L&M 0.07	55.69
--------------	------------------------	-------	------	-------	------	--	------------------------	-------

- Bridge Painter
- Epoxy Applicator
- Industrial Coatings Specialist
- Pot Tender
- Sandblasting
- Specialty Painter
- Structural Steel Painter

S1304	Group IV, including:	39.85	8.71	15.41	1.08		L&M 0.07	65.12
--------------	----------------------	-------	------	-------	------	--	------------------------	-------

- Glazier
- Storefront/Automatic Door Mechanic

S1305	Group V, including:	28.63	8.71	5.02	0.83		L&M 0.07	43.26
--------------	---------------------	-------	------	------	------	--	------------------------	-------

- Carpet Installer
- Floor Coverer
- Heat Weld/Cove Base
- Linoleum/Soft Tile Installer

Piledrivers

*See per diem note on last page

A1401	Piledriver	38.34	10.08	15.23	1.10		L&M 0.10	IAF 0.10	64.95
--------------	------------	-------	-------	-------	------	--	------------------------	--------------------	-------

- Assistant Dive Tender
- Carpenter/Piledriver
- Rigger
- Sheet Stabber
- Skiff Operator

Wage benefits key: BHR=basic hourly rate; H&W=health and welfare; IAF=industry advancement fund; LEG=legal fund; L&M=labor/management fund; PEN=pens fund; SAF=safety; SUI=supplemental unemployment insurance; S&L=SUI & LEG combined; TRN=training; THR=total hourly rate; VAC=vacation

Class Code	Classification of Laborers & Mechanics	BHR	H&W	PEN	TRN	Other	Benefits	THR
------------	--	-----	-----	-----	-----	-------	----------	-----

Piledrivers
*See per diem note on last page

A1402	Piledriver-Welder/Toxic Worker	39.34	10.08	15.23	1.10	L&M	IAF	65.95
A1403	Remotely Operated Vehicle Pilot/Technician Single Atmosphere Suit, Bell or Submersible Pilot	42.65	10.08	15.23	1.10	L&M	IAF	69.26
A1404	Diver (working) **See note on last page	82.45	10.08	15.23	1.10	L&M	IAF	109.06
A1405	Diver (standby) **See note on last page	42.65	10.08	15.23	1.10	L&M	IAF	69.26
A1406	Dive Tender **See note on last page	41.65	10.08	15.23	1.10	L&M	IAF	68.26
A1407	Welder (American Welding Society, Certified Welding Inspector)	43.90	10.08	15.23	1.10	L&M	IAF	70.51

Plumbers, Region I (North of N63 latitude)
*See per diem note on last page

N1501	Journeyman Pipefitter Plumber Welder	41.91	11.25	17.20	1.50	L&M	S&L	72.51
--------------	--	-------	-------	-------	------	-----	-----	-------

Plumbers, Region II (South of N63 latitude)
*See per diem note on last page

S1501	Journeyman Pipefitter Plumber Welder	41.00	11.13	15.02	1.55	L&M		68.90
--------------	--	-------	-------	-------	------	-----	--	-------

Plumbers, Region IIA (1st Judicial District)
*See per diem note on last page

X1501	Journeyman Pipefitter Plumber Welder	38.82	13.37	11.75	2.50	L&M		66.68
--------------	--	-------	-------	-------	------	-----	--	-------

Power Equipment Operators
*See per diem note on last page

A1601	Group I, including:	41.53	10.35	13.00	1.00	L&M		66.03
--------------	---------------------	-------	-------	-------	------	-----	--	-------

Wage benefits key: BHR=basic hourly rate; H&W=health and welfare; IAF=industry advancement fund; LEG=legal fund; L&M=labor/management fund; PEN=pens fund; SAF=safety; SUI=supplemental unemployment insurance; S&L=SUI & LEG combined; TRN=training; THR=total hourly rate; VAC=vacation

Power Equipment Operators

*See per diem note on last page

	L&M						
A1601 Group I, including:	41.53	10.35	13.00	1.00	0.10	0.05	66.03
Asphalt Roller: Breakdown, Intermediate, and Finish							
Back Filler							
Barrier Machine (Zipper)							
Beltcrete with Power Pack & similar conveyors							
Bending Machine							
Boat Coxswain							
Bulldozer							
Cableways, Highlines & Cablecars							
Cleaning Machine							
Coating Machine							
Concrete Hydro Blaster							
Cranes (45 tons & under or 150 feet of boom & under (including jib & attachments))							
(a) Hydralifts or Transporters, (all track or truck type)							
(b) Derricks							
(c) Overhead							
Crushers							
Deck Winches, Double Drum							
Ditching or Trenching Machine (16 inch or over)							
Drag Scraper, Yarder, and similar types							
Drilling Machines, Core, Cable, Rotary and Exploration							
Finishing Machine Operator, Concrete Paving, Laser Screed, Sidewalk, Curb & Gutter Machine							
Grade Checker and/or Line and Grade including Drone							
Helicopters							
Hover Craft, Flex Craft, Loadmaster, Air Cushion, All-Terrain Vehicle, Rollagon, Bargecable, Nodwell, & Snow Cat							
Hydro Ax, Feller Buncher & similar							
Hydro Excavation (Vac-Truck and Similar)							
Loaders (2 1/2 yards through 5 yards, including all attachments):							
(a) Forklifts (with telescopic boom & swing attachment)							
(b) Front End & Overhead, (2-1/2 yards through 5 yards)							
(c) Loaders, (with forks or pipe clamp)							
(d) Loaders, (elevating belt type, Euclid & similar types)							
Material Transfer Vehicle (Elevating Grader, Pickup Machine, and similar types)							
Mechanic, Welder, Bodyman, Electrical, Camp & Maintenance Engineer							
Micro Tunneling Machine							
Mixers: Mobile type with hoist combination							
Motor Patrol Grader							

Wage benefits key: BHR=basic hourly rate; H&W=health and welfare; IAF=industry advancement fund; LEG=legal fund; L&M=labor/management fund; PEN=pens fund; SAF=safety; SUI=supplemental unemployment insurance; S&L=SUI & LEG combined; TRN=training; THR=total hourly rate; VAC=vacation

Power Equipment Operators

*See per diem note on last page

						L&M			
A1601	Group I, including:	41.53	10.35	13.00	1.00	0.10	0.05	66.03	

- Mucking Machine: Mole, Tunnel Drill, Horizontal/Directional Drill Operator and/or Shield
- Off-Road Hauler (including Articulating and Haul Trucks)
- Operator on Dredges
- Piledriver Engineer, L.B. Foster, Puller or similar paving breaker
- Plant Operator (Asphalt & Concrete)
- Power Plant, Turbine Operator 200 k.w & over (power plants or combination of power units over 300 k.w.)
- Remote Controlled Equipment
- Scraper (through 40 yards)
- Service Oiler/Service Engineer
- Shot Blast Machine
- Shovels, Backhoes, Excavators with all attachments, and Gradealls (3 yards & under)
- Sideboom (under 45 tons)
- Sub Grader (Gurries & similar types)
- Tack Tractor
- Truck Mounted Concrete Pump, Conveyor/Tele-belt, & Creter
- Wate Kote Machine

						L&M			
A1602	Group IA, including:	43.29	10.35	13.00	1.00	0.10	0.05	67.79	

- Camera/Tool/Video Operator (Slipline)
- Certified Welder, Electrical Mechanic, Camp Maintenance Engineer, Mechanic (over 10,000 hours)
- Cranes (over 45 tons or 150 feet including jib & attachments)
 - (a) Clamshells & Draglines (over 3 yards)
 - (b) Tower Cranes
- Licensed Water/Waste Water Treatment Operator
- Loaders (over 5 yards)
- Motor Patrol Grader, Dozer, Grade Tractor (finish: when finishing to final grade and/or to hubs, or for asphalt)
- Power Plants (1000 k.w. & over)
- Profiler, Reclaimer, and Roto-Mill
- Quad
- Scrapers (over 40 yards)
- Screed
- Shovels, Backhoes, Excavators with all attachments (over 3 yards)
- Sidebooms (over 45 tons)
- Slip Form Paver, C.M.I. & similar types
- Topside (Asphalt Paver, Slurry machine, Spreaders, and similar types)

Wage benefits key: BHR=basic hourly rate; H&W=health and welfare; IAF=industry advancement fund; LEG=legal fund; L&M=labor/management fund; PEN=pens fund; SAF=safety; SUI=supplemental unemployment insurance; S&L=SUI & LEG combined; TRN=training; THR=total hourly rate; VAC=vacation

Power Equipment Operators

*See per diem note on last page

	L&M						
A1603 Group II, including:	40.76	10.35	13.00	1.00	0.10	0.05	65.26
Boiler - Fireman							
Cement Hogs & Concrete Pump Operator							
Conveyors (except those listed in Group I)							
Hoists on Steel Erection, Towermobiles & Air Tuggers							
Horizontal/Directional Drill Locator							
Locomotives, Rod & Geared Engines							
Mixers							
Screening, Washing Plant							
Sideboom (cradling rock drill, regardless of size)							
Skidder							
Trenching Machines (under 16 inches)							
Water/Waste Water Treatment Operator							

	L&M						
A1604 Group III, including:	40.04	10.35	13.00	1.00	0.10	0.05	64.54
"A" Frame Trucks, Deck Winches							
Bombardier (tack or tow rig)							
Boring Machine							
Brooms, Power (sweeper, elevator, vacuum, or similar)							
Bump Cutter							
Compressor							
Farm Tractor							
Forklift, Industrial Type							
Gin Truck or Winch Truck (with poles when used for hoisting)							
Hoists, Air Tuggers, Elevators							
Loaders:							
(a) Elevating-Athey, Barber Greene & similar types							
(b) Forklifts or Lumber Carrier (on construction job sites)							
(c) Forklifts, (with tower)							
(d) Overhead & Front End, (under 2-1/2 yards)							
Locomotives: Dinkey (air, steam, gas & electric) Speeders							
Mechanics, Light Duty							
Oil, Blower Distribution							
Posthole Digger, Mechanical							
Pot Fireman (power agitated)							
Power Plant, Turbine Operator, (under 200 k.w.)							
Pumps, Water							
Roller (other than Asphalt)							
Saws, Concrete							
Skid Hustler							
Skid Steer (with all attachments)							

Wage benefits key: BHR=basic hourly rate; H&W=health and welfare; IAF=industry advancement fund; LEG=legal fund; L&M=labor/management fund; PEN=pens fund; SAF=safety; SUI=supplemental unemployment insurance; S&L=SUI & LEG combined; TRN=training; THR=total hourly rate; VAC=vacation

Class Code	Classification of Laborers & Mechanics	BHR	H&W	PEN	TRN	Other	Benefits	THR
------------	--	-----	-----	-----	-----	-------	----------	-----

Power Equipment Operators
 *See per diem note on last page

A1604	Group III, including:	40.04	10.35	13.00	1.00		L&M	
	Stake Hopper					0.10	0.05	64.54
	Straightening Machine							
	Tow Tractor							

A1605	Group IV, including:	33.83	10.35	13.00	1.00		L&M	
	Crane Assistant Engineer/Rig Oiler					0.10	0.05	58.33
	Drill Helper							
	Parts & Equipment Coordinator							
	Spotter							
	Steam Cleaner							
	Swamper (on trenching machines or shovel type equipment)							

Roofers
 *See per diem note on last page

A1701	Rofer & Waterproofer	44.62	11.75	3.91	0.81		L&M	
						0.10	0.06	61.25
A1702	Rofer Material Handler	31.23	11.75	3.91	0.81		L&M	
						0.10	0.06	47.86

Sheet Metal Workers, Region I (North of N63 latitude)
 *See per diem note on last page

N1801	Sheet Metal Journeyman	48.64	11.50	14.11	1.65		L&M	
	Air Balancing and duct cleaning of HVAC systems					0.12		76.02
	Brazing, soldering or welding of metals							
	Demolition of sheet metal HVAC systems							
	Fabrication and installation of exterior wall sheathing, siding, metal roofing, flashing, decking and architectural sheet metal work							
	Fabrication and installation of heating, ventilation and air conditioning ducts and equipment							
	Fabrication and installation of louvers and hoods							
	Fabrication and installation of sheet metal lagging							
	Fabrication and installation of stainless steel commercial or industrial food service equipment							
	Manufacture, fabrication assembly, installation and alteration of all ferrous and nonferrous metal work							
	Metal lavatory partitions							
	Preparation of drawings taken from architectural and engineering plans required for fabrication and erection of sheet metal work							

Wage benefits key: BHR=basic hourly rate; H&W=health and welfare; IAF=industry advancement fund; LEG=legal fund; L&M=labor/management fund; PEN=pens fund; SAF=safety; SUI=supplemental unemployment insurance; S&L=SUI & LEG combined; TRN=training; THR=total hourly rate; VAC=vacation

Sheet Metal Workers, Region I (North of N63 latitude)

*See per diem note on last page

N1801	Sheet Metal Journeyman	48.64	11.50	14.11	1.65	0.12	L&M	76.02
--------------	------------------------	-------	-------	-------	------	------	----------------	-------

- Sheet Metal shelving
- Sheet Metal venting, chimneys and breaching
- Skylight installation

Sheet Metal Workers, Region II (South of N63 latitude)

*See per diem note on last page

S1801	Sheet Metal Journeyman	43.20	11.50	14.09	1.68	0.43	L&M	70.90
--------------	------------------------	-------	-------	-------	------	------	----------------	-------

- Air Balancing and duct cleaning of HVAC systems
- Brazing, soldering or welding of metals
- Demolition of sheet metal HVAC systems
- Fabrication and installation of exterior wall sheathing, siding, metal roofing, flashing, decking and architectural sheet metal work
- Fabrication and installation of heating, ventilation and air conditioning ducts and equipment
- Fabrication and installation of louvers and hoods
- Fabrication and installation of sheet metal lagging
- Fabrication and installation of stainless steel commercial or industrial food service equipment
- Manufacture, fabrication assembly, installation and alteration of all ferrous and nonferrous metal work
- Metal lavatory partitions
- Preparation of drawings taken from architectural and engineering plans required for fabrication and erection of sheet metal work
- Sheet Metal shelving
- Sheet Metal venting, chimneys and breaching
- Skylight installation

Sprinkler Fitters

*See per diem note on last page

A1901	Sprinkler Fitter	47.25	10.23	17.85	0.52	0.25	L&M	76.10
--------------	------------------	-------	-------	-------	------	------	----------------	-------

Surveyors

*See per diem note on last page

A2001	Chief of Parties	44.16	11.43	12.64	1.15	0.10	L&M	69.48
--------------	------------------	-------	-------	-------	------	------	----------------	-------

A2002	Party Chief	42.57	11.43	12.64	1.15	0.10	L&M	67.89
--------------	-------------	-------	-------	-------	------	------	----------------	-------

Wage benefits key: BHR=basic hourly rate; H&W=health and welfare; IAF=industry advancement fund; LEG=legal fund; L&M=labor/management fund; PEN=pens fund; SAF=safety; SUI=supplemental unemployment insurance; S&L=SUI & LEG combined; TRN=training; THR=total hourly rate; VAC=vacation

Class Code	Classification of Laborers & Mechanics	BHR	H&W	PEN	TRN	Other Benefits	THR
------------	--	-----	-----	-----	-----	----------------	-----

Surveyors

*See per diem note on last page

A2003	Line & Grade Technician/Office Technician/GPS, Drones	41.97	11.43	12.64	1.15	L&M 0.10	67.29
A2004	Associate Party Chief (including Instrument Person & Head Chain Person)/Stake Hop/Grademan	39.85	11.43	12.64	1.15	L&M 0.10	65.17
A2006	Chain Person (for crews with more than 2 people)	35.51	11.43	12.64	1.15	L&M 0.10	60.83

Truck Drivers

*See per diem note on last page

A2101	Group I, including: Air/Sea Traffic Controllers Ambulance/Fire Truck Driver (EMT certified) Boat Coxswain Captains & Pilots (air & water) Deltas, Commanders, Rollagons, & similar equipment (when pulling sleds, trailers or similar equipment) Dump Trucks (including rockbuggy, side dump, belly dump, & trucks with pups) over 40 yards up to & including 60 yards Helicopter Transporter Liquid Vac Truck/Super Vac Truck Material Coordinator or Purchasing Agent Ready-mix (over 12 yards up to & including 15 yards) (over 15 yards to be negotiated) Semi with Double Box Mixer Tireman, Heavy Duty/Fueler Water Wagon (250 Bbls and above)	40.94	11.43	12.64	1.15	L&M 0.10	66.26
A2102	Group 1A including: Dump Trucks (including rockbuggy, side dump, belly dump & trucks with pups) over 60 yards up to & including 100 yards (over 100 yards to be negotiated) Jeeps (driver under load) Lowboys, including tractor attached trailers & jeeps, up to & including 12 axles (over 12 axles or 150 tons to be negotiated)	42.21	11.43	12.64	1.15	L&M 0.10	67.53
A2103	Group II, including: All Deltas, Commanders, Rollagons, & similar equipment Batch Trucks (8 yards & up) Batch Trucks (up to & including 7 yards)	39.68	11.43	12.64	1.15	L&M 0.10	65.00

Wage benefits key: BHR=basic hourly rate; H&W=health and welfare; IAF=industry advancement fund; LEG=legal fund; L&M=labor/management fund; PEN=pens fund; SAF=safety; SUI=supplemental unemployment insurance; S&L=SUI & LEG combined; TRN=training; THR=total hourly rate; VAC=vacation

Truck Drivers

*See per diem note on last page

A2103 Group II, including:	39.68	11.43	12.64	1.15	L&M		0.10	65.00
-----------------------------------	-------	-------	-------	------	----------------	--	------	-------

- Boom Truck/Knuckle Truck (over 5 tons)
- Cacasco Truck/Heat Stress Truck
- Construction and Material Safety Technician
- Dump Trucks (including rockbuggy, side dump, belly dump, & trucks with pups) over 20 yards up to & including 40 yards
- Gin Pole Truck, Winch Truck, Wrecker (truck mounted "A" frame manufactured rating over 5 tons)
- Mechanics
- Oil Distributor Driver
- Partsman
- Ready-mix (up to & including 12 yards)
- Stringing Truck
- Turn-O-Wagon or DW-10 (not self loading)

A2104 Group III, including:	38.86	11.43	12.64	1.15	L&M		0.10	64.18
------------------------------------	-------	-------	-------	------	----------------	--	------	-------

- Boom Truck/Knuckle Truck (up to & including 5 tons)
- Dump Trucks (including rockbuggy, side dump, belly dump, & trucks with pups) over 10 yards up to & including 20 yards
- Expeditor (electrical & pipefitting materials)
- Gin Pole Truck, Winch Truck, Wrecker (truck mounted "A" frame manufactured rating 5 tons & under)
- Greaser - Shop
- Semi or Truck & Trailer
- Thermal Plastic Layout Technician
- Traffic Control Technician
- Trucks/Jeeps (push or pull)

A2105 Group IV, including:	38.28	11.43	12.64	1.15	L&M		0.10	63.60
-----------------------------------	-------	-------	-------	------	----------------	--	------	-------

- Air Cushion or similar type vehicle
- All Terrain Vehicle
- Buggymobile
- Bull Lift & Fork Lift, Fork Lift with Power Boom & Swing Attachment (over 5 tons)
- Bus Operator (over 30 passengers)
- Cement Spreader, Dry
- Combination Truck-Fuel & Grease
- Compactor (when pulled by rubber tired equipment)
- Dump Trucks (including rockbuggy, side dump, belly dump, & trucks with pups) up to & including 10 yards
- Dumpster

Wage benefits key: BHR=basic hourly rate; H&W=health and welfare; IAF=industry advancement fund; LEG=legal fund; L&M=labor/management fund; PEN=pens fund; SAF=safety; SUI=supplemental unemployment insurance; S&L=SUI & LEG combined; TRN=training; THR=total hourly rate; VAC=vacation

Truck Drivers
 *See per diem note on last page

						L&M	
A2105	Group IV, including:	38.28	11.43	12.64	1.15	0.10	63.60
	Expeditor (general)						
	Fire Truck/Ambulance Driver						
	Flat Beds, Dual Rear Axle						
	Foam Distributor Truck Dual Axle						
	Front End Loader with Fork						
	Grease Truck						
	Hydro Seeder, Dual Axle						
	Hyster Operators (handling bulk aggregate)						
	Loadmaster (air & water operations)						
	Lumber Carrier						
	Ready-mix, (up to & including 7 yards)						
	Rigger (air/water/oilfield)						
	Tireman, Light Duty						
	Track Truck Equipment						
	Truck Vacuum Sweeper						
	Warehouseperson						
	Water Truck (Below 250 Bbls)						
	Water Truck (straight)						
	Water Wagon, Semi						

						L&M	
A2106	Group V, including:	37.52	11.43	12.64	1.15	0.10	62.84
	Buffer Truck						
	Bull Lifts & Fork Lifts, Fork Lifts with Power Boom & Swing Attachments (up to & including 5 tons)						
	Bus Operator (up to 30 passengers)						
	Farm Type Rubber Tired Tractor (when material handling or pulling wagons on a construction project)						
	Flat Beds, Single Rear Axle						
	Foam Distributor Truck Single Axle						
	Fuel Handler (station/bulk attendant)						
	Gear/Supply Truck						
	Gravel Spreader Box Operator on Truck						
	Hydro Seeders, Single axle						
	Pickups (pilot cars & all light-duty vehicles)						
	Rigger/Swamper						
	Tack Truck						
	Team Drivers (horses, mules, & similar equipment)						

Tunnel Workers, Laborers (The Alaska areas north of N63 latitude and east of W138 longitude)
 *See per diem note on last page

Wage benefits key: BHR=basic hourly rate; H&W=health and welfare; IAF=industry advancement fund; LEG=legal fund; L&M=labor/management fund; PEN=pens fund; SAF=safety; SUI=supplemental unemployment insurance; S&L=SUI & LEG combined; TRN=training; THR=total hourly rate; VAC=vacation

Tunnel Workers, Laborers (The Alaska areas north of N63 latitude and east of W138 longitude)
 *See per diem note on last page

						L&M	LEG	
N2201	Group I, including:	34.88	8.95	17.81	1.30	0.20	0.20	63.34
	Brakeman							
	Mucker							
	Nipper							
	Storm Water Pollution Protection Plan Worker (SWPPP Worker - erosion and sediment control Laborer)							
	Topman & Bull Gang							
	Tunnel Track Laborer							

						L&M	LEG	
N2202	Group II, including:	35.98	8.95	17.81	1.30	0.20	0.20	64.44
	Burning & Cutting Torch							
	Certified Erosion Sediment Control Lead (CESCL Laborer)							
	Concrete Laborer							
	Floor Preparation, Core Drilling							
	Jackhammer/Chipping Gun or Pavement Breaker							
	Laser Instrument Operator							
	Nozzlemen, Pumcrete or Shotcrete							
	Pipelayer Helper							

						L&M	LEG	
N2203	Group III, including:	36.97	8.95	17.81	1.30	0.20	0.20	65.43
	Miner							
	Retimberman							

						L&M	LEG	
N2204	Group IIIA, including:	40.58	8.95	17.81	1.30	0.20	0.20	69.04
	Asphalt Raker, Asphalt Belly Dump Lay Down							
	Drill Doctor (in the field)							
	Driller (including, but not limited to wagon drills, air-track drills, hydraulic drills)							
	Pioneer Drilling & Drilling Off Tugger (all type drills)							
	Pipelayer							
	Powderman (Employee Possessor)							
	Storm Water Pollution Protection Plan Specialist (SWPPP Specialist)							
	Traffic Control Supervisor, DOT Qualified							

						L&M	LEG	
N2206	Group IIIB, including:	44.75	6.24	17.81	1.30	0.20	0.20	70.50
	Driller (including, but not limited to wagon drills, air-track drills, hydraulic drills)(over 5,000 hours)							
	Federal Powderman (Responsible Person in Charge)							
	Grade Checking (setting or transferring of grade marks, line and grade, GPS, drones)							

Wage benefits key: BHR=basic hourly rate; H&W=health and welfare; IAF=industry advancement fund; LEG=legal fund; L&M=labor/management fund; PEN=pens fund; SAF=safety; SUI=supplemental unemployment insurance; S&L=SUI & LEG combined; TRN=training; THR=total hourly rate; VAC=vacation

Tunnel Workers, Laborers (The Alaska areas north of N63 latitude and east of W138 longitude)
 *See per diem note on last page

						L&M	LEG	
N2206	Group IIIB, including:	44.75	6.24	17.81	1.30	0.20	0.20	70.50
	Pioneer Drilling & Drilling Off Tugger (all type drills)(over 5,000 hours)							
	Stake Hopper							

Tunnel Workers, Laborers (The area that is south of N63 latitude and west of W138 longitude)
 *See per diem note on last page

						L&M	LEG	
S2201	Group I, including:	34.88	8.95	17.81	1.30	0.20	0.20	63.34
	Brakeman							
	Mucker							
	Nipper							
	Storm Water Pollution Protection Plan Worker (SWPPP Worker - erosion and sediment control Laborer)							
	Topman & Bull Gang							
	Tunnel Track Laborer							

						L&M	LEG	
S2202	Group II, including:	35.98	8.95	17.81	1.30	0.20	0.20	64.44
	Burning & Cutting Torch							
	Certified Erosion Sediment Control Lead (CESCL Laborer)							
	Concrete Laborer							
	Floor Preparation, Core Drilling							
	Jackhammer/Chipping Gun or Pavement Breaker							
	Laser Instrument Operator							
	Nozzlemen, Pumcrete or Shotcrete							
	Pipelayer Helper							

						L&M	LEG	
S2203	Group III, including:	36.97	8.95	17.81	1.30	0.20	0.20	65.43
	Miner							
	Retimberman							

						L&M	LEG	
S2204	Group IIIA, including:	40.58	8.95	17.81	1.30	0.20	0.20	69.04
	Asphalt Raker, Asphalt Belly Dump Lay Down							
	Drill Doctor (in the field)							
	Driller (including, but not limited to wagon drills, air-track drills, hydraulic drills)							
	Pioneer Drilling & Drilling Off Tugger (all type drills)							
	Pipelayer							
	Powderman (Employee Possessor)							
	Storm Water Pollution Protection Plan Specialist (SWPPP Specialist)							

Wage benefits key: BHR=basic hourly rate; H&W=health and welfare; IAF=industry advancement fund; LEG=legal fund; L&M=labor/management fund; PEN=pens fund; SAF=safety; SUI=supplemental unemployment insurance; S&L=SUI & LEG combined; TRN=training; THR=total hourly rate; VAC=vacation

Class Code	Classification of Laborers & Mechanics	BHR	H&W	PEN	TRN	Other	Benefits	THR
------------	--	-----	-----	-----	-----	-------	----------	-----

Tunnel Workers, Laborers (The area that is south of N63 latitude and west of W138 longitude)
 *See per diem note on last page

S2204	Group IIIA, including:	40.58	8.95	17.81	1.30		L&M	LEG	
							0.20	0.20	69.04

Traffic Control Supervisor, DOT Qualified

S2206	Group IIIB, including:	44.75	6.24	17.81	1.30		L&M	LEG	
							0.20	0.20	70.50

Driller (including, but not limited to wagon drills, air-track drills, hydraulic drills)(over 5,000 hours)
 Federal Powderman (Responsible Person in Charge)
 Grade Checking (setting or transferring of grade marks, line and grade, GPS, drones)
 Pioneer Drilling & Drilling Off Tugger (all type drills)(over 5,000 hours)
 Stake Hopper

Tunnel Workers, Power Equipment Operators
 *See per diem note on last page

A2207	Group I	45.68	10.35	13.00	1.00		L&M		
							0.10	0.05	70.18

A2208	Group IA	47.62	10.35	13.00	1.00		L&M		
							0.10	0.05	72.12

A2209	Group II	44.84	10.35	13.00	1.00		L&M		
							0.10	0.05	69.34

A2210	Group III	44.04	10.35	13.00	1.00		L&M		
							0.10	0.05	68.54

A2211	Group IV	37.21	10.35	13.00	1.00		L&M		
							0.10	0.05	61.71

* Per diem is an established practice for this classification. This means that per diem is an allowable alternative to board and lodging if all criteria are met. See 8 AAC 30.051-08 AAC 30.056, and the per diem information on page vii of this Pamphlet.

** Work in combination of classifications: Employees working in any combination of classifications within the diving crew (working diver, standby diver, and tender) in a shift are paid in the classification with the highest rate for a minimum of 8 hours per shift.

Wage benefits key: BHR=basic hourly rate; H&W=health and welfare; IAF=industry advancement fund; LEG=legal fund; L&M=labor/management fund; PEN=pens fund; SAF=safety; SUI=supplemental unemployment insurance; S&L=SUI & LEG combined; TRN=training; THR=total hourly rate; VAC=vacation

SECTION 00852 - PERMITS

PART 1 - GENERAL

1.1 INDEX OF PERMITS

- A. Building Permit to be obtained by Owner.

PART 2 – PRODUCTS (Not Used)

PART 3 – EXECUTION (Not Used)

END OF SECTION

SECTION 00853 - STANDARD DETAILS

PART 1 - GENERAL

1.1 STANDARD DETAILS

- A. Whenever references are made to the Standard Drawings or Standard Details in these plans or Specifications the intent is to refer to the current City and Borough of Juneau Standard Details (currently the 4th Edition dated August 2011), copies of which may be purchased from the CBJ Engineering Department.

- B. City and Borough of Juneau Standard Details which specifically apply to this Project include but are not limited to the following:

LIST OF DETAILS

STANDARD
DETAIL

NO.

NAME OF DETAIL

118

STREET LIGHTING

119A

JUNCTION BOX TYPE 1 & TYPE 1A

PART 2 - PRODUCTS (Not Used)

PART 3 - EXECUTION (Not Used)

END OF SECTION

SPECIAL PROVISIONS

The Standard Specifications for Civil Engineering Projects and Subdivision Improvements December 2003 Edition, with sixteen (16) Errata Sheets, as published by the City and Borough of Juneau, is part of these Contract Documents and shall pertain to all phases of the contract. The Standard Specifications for Civil Engineering Projects and Subdivision Improvements December 2003 Edition is available for a fee from the City and Borough of Juneau Engineering Contracts Office, (907) 586-0490, or you may view them online at: www.juneau.org/engineering.

Special Provisions - Table of Contents

Section No.	Section Title	Page No.
01010	Summary of Work	1
01025	Measurement and Payment	4
01550	Site Access and Storage	6
01700	Project Closeout	6
16060	Grounding and Bonding	12
16073	Hangars and Supports for Electrical Systems	14
16075	Electrical Identification	18
16120	Conductors and Cables	21
16130	Raceways and Boxes	24
16521	Exterior Lighting	29

Add the following Section:

SECTION 01010 - SUMMARY OF WORK

PART 1 - GENERAL

1.1 GENERAL

- A. The WORK to be performed under this contract shall consist of furnishing all plant, tools, equipment, materials, supplies, manufactured articles and furnishing all labor, transportation and services, including all fuel, power, water and essential communications and performing all WORK, or other operations required for the fulfillment of the contract in strict accordance with the Contract Documents. The WORK shall be complete, and all WORK, materials, and services, not expressly indicated or called for in the Contract Documents which may be necessary for the complete and proper construction of the WORK in good faith shall be provided by the CONTRACTOR as though originally so indicated, at no increase in cost to the OWNER.

1.2 WORK COVERED BY CONTRACT DOCUMENTS

- A. The WORK covered in the Contract Documents generally includes: Replacing existing concrete footing with new precast concrete footing, removal of existing junction boxes and replacing with 27 new concrete junction boxes, removal of existing light poles and light fixtures and replacing with new light poles and light

SPECIAL PROVISIONS

fixtures. The WORK also includes replacing existing lighting circuit with all new conductors and installation of new 1.5 inch underground PVC conduit between concrete junction box and concrete footing and University Drive lighting system power.

- B. **SITE OF WORK.** The site of the WORK is on University Drive, the road to UAS Housing in the Auke Bay area of Juneau, Alaska.

1.3 WORK BY OTHERS

- A. The CONTRACTOR's attention is directed to the fact that work may be conducted at the site by other contractors during the performance of the WORK under this contract. The CONTRACTOR shall conduct its operations so as to cause a minimum of interference with the WORK of such other contractors, and shall cooperate fully with such contractors to provide continued safe access to their respective portions of the site, as required to perform work under their respective contracts.
- B. **Interference with Work on Utilities.** The CONTRACTOR shall cooperate fully with all utility forces of the OWNER or private agencies engaged in the relocation, altering, or otherwise rearranging of any facilities which interfere with the progress of the WORK, and shall schedule the WORK so as to minimize interference with said relocation, altering, or other rearranging of facilities.

1.4 CONTRACTOR USE OF PROJECT SITE

- A. The CONTRACTOR's use of the Project site shall include construction operations and storage of materials, fabrication facilities, and field offices only in those areas identified on the Drawings.

1.5 OWNER USE OF THE PROJECT SITE

- A. The OWNER may utilize all or part of the existing site during the entire period of construction for the conduct of the OWNER's normal operations. The CONTRACTOR shall cooperate and coordinate with the ENGINEER to facilitate the OWNER's operations and to minimize interference with the CONTRACTOR's operation at the same time. In any event, the OWNER shall be allowed access to the Project site during the period of construction.

1.6 PROJECT MEETINGS

- A. **Pre-Construction Conference**
 - 1. Prior to the commencement of WORK at the site, a Pre-Construction Conference will be held at a mutually agreed time and place which shall be attended by the CONTRACTOR's Project Manager, its superintendent, and

SPECIAL PROVISIONS

its Subcontractors as the CONTRACTOR deems appropriate. Other attendants will be:

- a. ENGINEER and Inspector.
 - b. Representatives of OWNER.
 - c. Governmental representatives as appropriate.
 - d. Others as requested by CONTRACTOR, OWNER, or ENGINEER.
2. Unless previously submitted to the ENGINEER, the CONTRACTOR shall bring to the Pre-Construction Conference one copy each of the following:
- a. Plan of Operation.
 - b. Project Overview Bar Chart Schedule.
 - c. Procurement schedule of major equipment and materials and items requiring long lead time.
 - d. Shop Drawing/Sample/Substitute or "Or Equal" submittal schedule.
 - e. Name and telephone number of CONTRACTOR's Project Supervisor.
3. The purpose of the Pre-Construction Conference is to designate responsible personnel and establish a working relationship. Matters requiring coordination will be discussed and procedure for handling such matters established. The complete agenda will be furnished to the CONTRACTOR prior to the meeting date. The CONTRACTOR should be prepared to discuss all of the items listed below:
- a. Status of CONTRACTOR's insurance and bonds.
 - b. CONTRACTOR's tentative schedules.
 - c. Transmittal, review, and distribution of CONTRACTOR's submittals.
 - d. Processing applications for payment.
 - e. Maintaining record documents.
 - f. Critical WORK sequencing.
 - g. Field decisions and Change Orders.
 - h. Use of Project site, office and storage areas, security, housekeeping, and OWNER's needs.
 - i. Major equipment deliveries and priorities.
 - j. CONTRACTOR's assignments for safety and first aid.
4. The OWNER will preside at the Pre-Construction Conference and will arrange for keeping and distributing the minutes to all persons in attendance.
5. The CONTRACTOR and its Subcontractors should plan on the conference taking no longer than three hours. Items listed in paragraph 3 will be covered as well as a review of the Drawings and Specifications with the ENGINEER and OWNER.

B. Progress Meetings

1. The CONTRACTOR shall schedule and hold regular on-site progress meetings at least weekly and at other times as requested by the ENGINEER, or as required by the progress of the WORK. The CONTRACTOR, ENGINEER, and all Subcontractors active on the site must attend each

SPECIAL PROVISIONS

meeting. CONTRACTOR may at its discretion request attendance by representatives of its Suppliers, manufacturers, and other Subcontractors.

2. The ENGINEER shall conduct the meeting and will arrange for recording and distributing the minutes. The purpose of the meetings will be to review the progress of the WORK, maintain coordination of efforts, discuss changes in scheduling, and resolve other problems which may develop. During each meeting, the CONTRACTOR is required to present any issues which may impact the WORK, with a view toward resolving these issues expeditiously.

1.7 DEFINITIONS APPLICABLE TO TECHNICAL SPECIFICATIONS

A. The following words have the meaning defined in the Technical Portions of the WORK:

1. Furnish - means to supply and deliver to the site, to unload and unpack ready for assembly, installation, testing, and start-up.
2. Indicated - is a word used to direct the CONTRACTOR to information contained on the drawings or in the Specifications. Terms such as “shown”, “noted”, “scheduled”, and “specified” also may be used to assist in locating information but no limitation of location is implied or intended.
3. Install - defines operations at the site including assembly, erection, placing, anchoring, applying, shaping to dimension, finishing, curing, protecting, and cleaning, ready for the OWNER’s use.
4. Installer - a person or firm engaged by the CONTRACTOR or its subcontract, or any Subcontractor, for the performance of installation, erection, or application WORK at the site. Installers must be expert in the operations they are engaged to perform.
5. Provide- is defined as furnish and install, ready for the intended use.

PART 2 - PRODUCTS (Not Used)

PART 3 - EXECUTION (Not Used)

END OF SECTION

Add the following Section:

SECTION 01025 – MEASUREMENT AND PAYMENT

PART 1 - GENERAL

1.1 SCOPE

- A. Payment for the various items of the Bid Schedule, as further specified herein, shall include all compensation to be received by the CONTRACTOR for furnishing all

SPECIAL PROVISIONS

tools, equipment, supplies, and manufactured articles, and for all labor, operations, and incidentals appurtenant to the items for WORK being described, as necessary to complete the various items of the WORK all in accordance with the requirements of the Contract Documents, including all appurtenances thereto, and including all costs of permits and cost of compliance with the regulations of public agencies having jurisdiction, including Safety and Health Requirements of Occupational Safety and Health Administration of the U.S. Department of Labor (OSHA) and Occupational Safety and Health Standards of the Alaska Department of Labor, Division of Labor Standards and Safety.

- B. No separate payment will be made for any Pay Item that is not specifically set forth in the Bid Schedule, and all costs therefore shall be included in the prices named in the Bid Schedule for the various appurtenant items of WORK.
- C. In addition to the other incidental items of WORK listed elsewhere in the contract, the following items shall also be considered as incidental to other items of WORK under this contract:
 - 1. Maintenance of all services through the Project area including power, water, storm and sanitary sewers, garbage pickup, mail delivery, and emergency vehicles.
 - 2. Traffic control, including flaggers, and installation and maintenance of traffic control devices in accordance with the Manual of Uniform Traffic Control Devices – Millennium Edition (MUTCD) and the current AKDOT&PF supplements.
 - 3. Repair or replacement of existing adjacent facilities including piping, landscaping, steel, timber, concrete and asphalt items.
 - 4. Final clean-up and site restoration.
 - 5. All WORK necessary for coordination of work to be accomplished by the private utility companies and property owners within the Project limits.
 - 6. All WORK required to notify utility users of pending utility shut downs.

1.2 MOBILIZATION (Pay Item No. 1505.1) PRICE BASED ON LUMP SUM PAY UNIT

- A. Measurement for payment for Mobilization will be based upon the completion of the entire WORK as a Lump Sum Pay Unit, complete, all in accordance with the requirements of the Contract Documents.
- B. Payment for Mobilization will be made at the amount shown on the Bid Schedule under Pay Item No. 1505.1, which payment will constitute full compensation for all WORK described in Section 01505 - Mobilization, as shown on the Drawings and as directed by the ENGINEER.
- C. Partial payments will be made as the WORK progresses as follows:

SPECIAL PROVISIONS

1. When 5% of the total original contract amount is earned from other Pay Items, 50% of the amount bid for Mobilization, or 5% of the original contract amount, whichever is lesser, will be paid.
2. When 10% of the total original contract amount is earned from other Pay Items, 100% of the amount bid for Mobilization, or 10% of the original contract amount, whichever is lesser, will be paid.
3. Upon completion of all WORK on the Project, payment of any amount bid for Mobilization in excess of 10% of the total contract amount will be paid.

1.3 TRAFFIC CONTROL (Pay Item No. 1550.1) PRICE BASED ON LUMP SUM PAY UNIT

- A. Measurement for payment for Traffic Control will be based upon the completion of the entire WORK as a Lump Sum Pay Unit, complete, all in accordance with the requirements of the Contract Documents.
- B. Work under this Pay Item includes furnishing a complete Traffic Control Plan (TCP) to the Engineer. The TCP includes, but is not limited to, signs, barricades, traffic cones, plastic safety fence, special signs, portable concrete barriers, flaggers and all other items required to direct traffic through or around the work zone.
- C. Payment for Traffic Control will be made at the amount shown on the Bid Schedule under Pay Item No. 1550.1, which payment will constitute full compensation for all WORK described in Section 01550 – Site Access and Storage, as shown on the Drawings and as directed by the ENGINEER.

1.4 STREET LIGHTING AND UTILITY INSTALLATION (Pay Item No. 16000.1) PRICE BASED ON LUMP SUM

- A. Measurement for payment for Street Lighting and utility coordination will be based upon the completion of the entire street lighting system WORK as a Lump Sum Pay Unit, complete as shown on the Drawings, all in accordance with the requirements of the Contract Documents. This work includes the contractor portion of utility service, street light poles and bases, conduit, junction boxes, cables and conductors, and all other work to provide operational street lighting as shown on the Drawings. Also included are spare conduits and junction boxes, as shown on the contract documents. This payment also includes coordination with utilities to allow them to perform their work.
- B. Payment for Street Lighting and utility coordination will be made at the amount named in the Bid Schedule under Pay Item No. 16000.1, which payment will constitute full compensation for all WORK described in Specification Sections 16060-16521, and as shown on the Drawings, and as directed by the ENGINEER.

SPECIAL PROVISIONS

END OF SECTION

SECTION 01550 – SITE ACCESS AND STORAGE, PART 1 – GENERAL, Article 1.3, MAINTENANCE OF TRAFFIC, *revise paragraph M to read:*

- M. Provide pedestrian detours as necessary around areas of construction. The CONTRACTOR shall provide smooth, graded pathways, free of mud, muck and other materials that will be objectionable to people in street shoes. The pathways shall be a minimum of 36-inches wide, and shall be clearly marked with staking, warning ribbons, or other methods to guide pedestrians through the construction areas and to their residence walkways, if applicable.

SECTION 01550 – SITE ACCESS AND STORAGE, PART 1 – GENERAL, Article 1.3, MAINTENANCE OF TRAFFIC, *paragraph S, add the following:*

5. University Drive is the only access into UAS Housing. If street closures are required they will be limited to one lane only for a duration of no more than one hour for each occurrence and shall be limited to the Contractor's work shift only. No street closures shall be permitted overnight. Contractor shall notify CBJ Police, CBJ Fire Department, and University in writing of closures at least 24 hours prior to any street closures.

SECTION 01700 – PROJECT CLOSE-OUT, PART 1 – GENERAL, Article 1.3, FINAL SUBMITTALS, Paragraph A. *Delete* items 6, 7 and 8 and *replace with the following subparagraph:*

6. Compliance Certificate and release, signed by the CONTRACTOR, shall be submitted to the Engineering Contract Administrator.

SECTION 01700 – PROJECT CLOSE-OUT, PART 1 – GENERAL, Article 1.3, FINAL SUBMITTALS, *Add the following paragraph:*

- C. Before final payment, the CONTRACTOR shall provide the OWNER with clearance from the Alaska Department of Labor and Workforce Development for the CONTRACTOR and all Subcontractors that have worked on the Project. This clearance shall indicate that all Employment Security Taxes have been paid. A

SPECIAL PROVISIONS

sample form for this propose is at the end of Section 00800 – supplementary General Conditions.

SECTION 01700 – PROJECT CLOSE-OUT, PART 1 – GENERAL, *Replace the COMPLIANCE CERTIFICATE AND RELEASE FORM with the following form:*

SPECIAL PROVISIONS

COMPLIANCE CERTIFICATE AND RELEASE FORM

PROJECT: University Drive Lighting Upgrade

CONTRACT NO: BE21-092

The **CONTRACTOR** must complete and submit this form to the Contract Administrator with respect to the entire contract and submit completed Subcontractor Compliance forms for each Subcontractor used on the Contract and listed on the Subcontractor report.

Completed forms shall be submitted upon completion of the Project. All requirements and submittals must be met before final payment will be made to the **CONTRACTOR**.

I certify that the following and any referenced attachments are true:

- All WORK has been performed, materials supplied, and requirements met in accordance with the applicable Drawings, Specifications, and Contract Documents.

- All payments to Subcontractors and Suppliers have been made in accordance with Alaska Statute 36.90.210. If not, please provide written explanation, for each case, why and the specific mutual payment agreement reached with the Supplier or Subcontractor.

- CHECK ONE:
 - All Suppliers and Subcontractors have been paid in full with no claims for labor, materials or other services outstanding.

 - The following Suppliers and Subcontractors are due final payment which will be made upon the release of the final payment by the CBJ. List the Suppliers and Subcontractors and the amount they are due below (attach separate sheet if necessary):

SPECIAL PROVISIONS

	Supplier or Subcontractor	Amount Owed
1.		\$
2.		\$
3.		\$
4.		\$
5.		\$
6.		\$
7.		\$

- All employees have been paid not less than the current prevailing wage rates set by the State of Alaska (or U.S. Department of Labor, as applicable).
- All equal employment opportunity, certified payroll and other reports have been filed in accordance with the prime contract.
- The attached list of Subcontractors is complete (required from CONTRACTOR). The City Engineer was advised and approved of all Subcontractors before WORK was performed and has approved any substitutions of Subcontractors.
- All DBE firms listed as a precondition of the prime contract award must have performed a commercially useful function in order for the WORK to count to a DBE goal. All DBE firms performed the WORK stated and have received at least the amount claimed for credit in the Contract Documents.
- All DBE Subcontractors must attach a signed statement of the payment amount received, the nature of WORK performed, whether any balance is outstanding, and indicate that no rebates are involved.
- If the amount paid is less than the amount originally claimed for DBE credit, the CONTRACTOR has attached approval from the City Engineer for underutilization.

I understand it is unlawful to misrepresent information in order to receive a payment which would otherwise be withheld if these conditions were not met. I am an authorized agent of this firm and sign this freely and voluntarily. The foregoing statements are true and apply to the following project contractor.

SPECIAL PROVISIONS

_____ Capacity: CONTRACTOR

Firm Name

Signed

Printed Name

Date

Return completed form to: Engineering Contracts Division, City and Borough of Juneau, 155 South Seward Street, Juneau, AK 99801 or by email to: contracts@juneau.org

Call (907) 586-0873 if we can be of further assistance, or if you have any questions.

SUBCONTRACTOR COMPLIANCE CERTIFICATE AND RELEASE FORM

PROJECT: University Drive Lighting Upgrade

CONTRACT NO: BE21-092

Each **SUBCONTRACTOR** must complete and submit this form to the Contract Administrator, through the General Contractor, with respect to the entire contract.

Completed forms shall be submitted upon completion of the Project. All requirements and submittals must be met before final payment will be made to the CONTRACTOR.

I certify that the following and any referenced attachments are true:

- All WORK has been performed, materials supplied, and requirements met in accordance with the applicable Drawings, Specifications, and Contract Documents.

SPECIAL PROVISIONS

- _____(name of firm) has been paid by the Contractor in accordance with Alaska Statute 36.90.210. (If not, please provide written explanation on an attached sheet, for each case. Provide specific details why payment was not made and the specific mutual payment agreement reached with the Contractor if it is still unresolved.)

- CHECK ONE:
 - I / WE have been paid in full by the Contractor, with no claims for labor, materials or other services outstanding.

 - I / WE are due the following amount from the Contractor which is included in the Contractors Request for Final Payment. WE are due a total of \$ _____ for the following individual items that have yet to be paid (attach separate sheet if necessary).

	Outstanding Payment Item	Outstanding Amount Owed
1.		\$
2.		\$
3.		\$
4.		\$
5.		\$
6.		\$
7.		\$

- All employees have been paid not less than the current prevailing wage rates set by the State of Alaska (or U.S. Department of Labor, as applicable).

- All equal employment opportunity, certified payroll and other reports have been filed in accordance with the prime contract.

I understand it is unlawful to misrepresent information in order to receive a payment which would otherwise be withheld if these conditions were not met. I am an authorized agent of this firm and

SPECIAL PROVISIONS

- B. Comply with UL 467 for grounding and bonding materials and equipment.

PART 2 - PRODUCTS

2.1 MANUFACTURERS

- A. Manufacturers: Subject to compliance with requirements, available manufacturers offering products that may be incorporated into the Work include, but are not limited to, the following:
 1. Burndy; Part of Hubbell Electrical Systems.
 2. Dossert; AFL Telecommunications LLC.
 3. ERICO International Corporation.
 4. Fushi Copperweld Inc.
 5. Galvan Industries, Inc.; Electrical Products Division, LLC.
 6. Harger Lightning and Grounding.
 7. ILSCO.
 8. O-Z/Gedney; A Brand of the EGS Electrical Group.
 9. Robbins Lightning, Inc.
 10. Siemens Power Transmission & Distribution, Inc.

2.2 SYSTEM DESCRIPTION

- A. Electrical Components, Devices, and Accessories: Listed and labeled as defined in NFPA 70, by a qualified testing agency, and marked for intended location and application.
- B. Comply with UL 467 for grounding and bonding materials and equipment.

2.3 CONDUCTORS

- A. Insulated Conductors: Copper or tinned-copper wire or cable insulated for 600 V unless otherwise required by applicable Code or authorities having jurisdiction.
- B. Bare Copper Conductors:
 1. Stranded Conductors: ASTM B 8.
 2. Tinned Conductors: ASTM B 33.
 3. Bonding Cable: 28 kcmil, 14 strands of No. 17 AWG conductor, 1/4 inch (6 mm) in diameter.
 4. Bonding Conductor: No. 4 or No. 6 stranded conductor.
 5. Bonding Jumper: Copper tape, braided conductors terminated with copper ferrules; 1-5/8 inches (41 mm) wide and 1/16 inch (1.6 mm) thick.
 6. Tinned Bonding Jumper: Tinned-copper tape, braided conductors terminated with copper ferrules; 1-5/8 inches (41 mm) wide and 1/16 inch (1.6 mm) thick.

SPECIAL PROVISIONS

2.4 CONNECTORS

- A. Listed and labeled by an NRTL acceptable to authorities having jurisdiction for applications in which used and for specific types, sizes, and combinations of conductors and other items connected.
- B. Bolted Connectors for Conductors: Copper or copper alloy.

2.5 GROUNDING ELECTRODES

- A. Ground Rods: Copper-clad; 5/8 by 96 inches (16 by 2400 mm).

PART 3 - EXECUTION

3.1 APPLICATIONS

- A. Conductors: Install stranded conductors and larger unless otherwise indicated.
- B. Underground Grounding Conductors: Install bare copper conductor, No. 2/0 AWG minimum.
 - 1. Bury at least 24 inches (600 mm) below grade.
 - 2. Duct-Bank Grounding Conductor: Bury 12 inches (300 mm) above duct bank when indicated as part of duct-bank installation.
- C. Conductor Terminations and Connections:
 - 1. Equipment Grounding Conductor Terminations: Bolted connectors.
 - 2. Underground Connections: Hi compression connectors except as otherwise indicated.
 - 3. Connections to Ground Rods: Bolted connectors.

3.2 GROUNDING UNDERGROUND DISTRIBUTION SYSTEM COMPONENTS

- A. Comply with IEEE C2 grounding requirements.
- B. Grounding Handholes: Install a driven ground rod through handhole floor, close to wall, and set rod depth so 4 inches (100 mm) will extend above floor. Bond with all metallic conduits and lid.

3.3 EQUIPMENT GROUNDING

- A. Install insulated equipment grounding conductors with all circuits.

SPECIAL PROVISIONS

END OF SECTION

SECTION 16073 – HANGERS AND SUPPORTS FOR ELECTRICAL SYSTEMS

PART 1 - GENERAL

1.1 RELATED DOCUMENTS

- A. Drawings and general provisions of the Contract, including General and Supplementary Conditions and Division 01 Specification Sections, apply to this Section.

1.2 SUMMARY

- A. This Section includes the following:
 - 1. Hangers and supports for electrical equipment and systems.
 - 2. Construction requirements for concrete bases.

1.3 DEFINITIONS

- A. EMT: Electrical metallic tubing.
- B. IMC: Intermediate metal conduit.
- C. RMC: Rigid metal conduit.

1.4 PERFORMANCE REQUIREMENTS

- A. Rated Strength: Adequate in tension, shear, and pullout force to resist maximum loads calculated or imposed for this Project, with a minimum structural safety factor of five times the applied force.

1.5 ACTION SUBMITTALS

- A. Product Data: For the following:
 - 1. Steel slotted support systems.

1.6 QUALITY ASSURANCE

- A. Welding: Qualify procedures and personnel according to AWS D1.1/D1.1M, "Structural Welding Code - Steel."
- B. Comply with NFPA 70.
- C. COORDINATION

SPECIAL PROVISIONS

Coordinate size and location of concrete bases. Cast anchor-bolt inserts into bases. Concrete, reinforcement, and formwork requirements are specified together with concrete Specifications. PART 2 - PRODUCTS

2.1 SUPPORT, ANCHORAGE, AND ATTACHMENT COMPONENTS

- A. Steel Slotted Support Systems: Comply with MFMA-4, factory-fabricated components for field assembly.
 - 1. Available Manufacturers: Subject to compliance with requirements, manufacturers offering products that may be incorporated into the Work include, but are not limited to, the following:
 - a. Allied Tube & Conduit.
 - b. Cooper B-Line, Inc.
 - c. ERICO International Corporation.
 - d. GS Metals Corp.
 - e. Thomas & Betts Corporation.
 - f. Unistrut; Atkore International.
 - g. Wesanco, Inc.
 - 2. Metallic Coatings: Hot-dip galvanized after fabrication and applied according to MFMA-4.
 - 3. Channel Dimensions: Selected for applicable load criteria.
- B. Raceway and Cable Supports: As described in NECA 1 and NECA 101.
- C. Conduit and Cable Support Devices: Steel and malleable-iron clamps, and associated fittings, designed for types and sizes of raceway or cable to be supported.
- D. Structural Steel for Fabricated Supports and Restraints: ASTM A 36/A 36M, steel plates, shapes, and bars; black and galvanized.
- E. Mounting, Anchoring, and Attachment Components: Items for fastening electrical items or their supports to building surfaces include the following:
 - 1. Powder-Actuated Fasteners: Threaded-steel stud, for use in hardened Portland cement concrete, steel, or wood, with tension, shear, and pullout capacities appropriate for supported loads and building materials where used.
 - A. Available Manufacturers: Subject to compliance with requirements, manufacturers offering products that may be incorporated into the Work include, but are not limited to, the following:
 - 1) Hilti, Inc.
 - 2) ITW Ramset/Red Head; Illinois Tool Works, Inc.
 - 3) MKT Fastening, LLC.
 - 4) Simpson Strong-Tie Co., Inc.

SPECIAL PROVISIONS

2. Mechanical-Expansion Anchors: Insert-wedge-type, stainless steel, for use in hardened Portland cement concrete with tension, shear, and pullout capacities appropriate for supported loads and building materials in which used.
 - A. Available Manufacturers: Subject to compliance with requirements, manufacturers offering products that may be incorporated into the Work include, but are not limited to, the following:
 - 1) Cooper B-Line, Inc.
 - 2) Empire Tool and Manufacturing Co., Inc.
 - 3) Hilti, Inc.
 - 4) ITW Ramset/Red Head; Illinois Tool Works, Inc.
 - 5) MKT Fastening, LLC.
3. Concrete Inserts: Steel or malleable-iron, slotted support system units similar to MSS Type 18; complying with MFMA-4 or MSS SP-58.
4. Clamps for Attachment to Steel Structural Elements: MSS SP-58, type suitable for attached structural element.
5. Through Bolts: Structural type, hex head, and high strength. Comply with ASTM A 325.
6. Toggle Bolts: All-steel springhead type.
7. Hanger Rods: Threaded steel.

2.2 FABRICATED METAL EQUIPMENT SUPPORT ASSEMBLIES

- A. Description: Welded or bolted, structural-steel shapes, shop or field fabricated to fit dimensions of supported equipment.

PART 3 - EXECUTION

3.1 APPLICATION

- A. Comply with NECA 1 and NECA 101 for application of hangers and supports for electrical equipment and systems except if requirements in this Section are stricter.
- B. Maximum Support Spacing for Raceway: Space supports for IMC and RMC as required by NFPA 70.

3.2 SUPPORT INSTALLATION

- A. Comply with NECA 1 and NECA 101 for installation requirements except as specified in this Article.
- B. Strength of Support Assemblies: Where not indicated, select sizes of components so strength will be adequate to carry present and future static loads within specified loading limits. Minimum static design load used for

SPECIAL PROVISIONS

strength determination shall be weight of supported components plus 200 lb (90 kg).

- C. Mounting and Anchorage of Surface-Mounted Equipment and Components: Anchor and fasten electrical items and their supports to building structural elements by the following methods unless otherwise indicated by code:
1. To Wood: Fasten with lag screws or through bolts.
 2. To New Concrete: Bolt to concrete inserts.
 3. To Masonry: Approved toggle-type bolts on hollow masonry units and expansion anchor fasteners on solid masonry units.
 4. To Existing Concrete: Expansion anchor fasteners.
 5. Instead of expansion anchors, powder-actuated driven threaded studs provided with lock washers and nuts may be used in existing standard-weight concrete 4 inches (100 mm) thick or greater. Do not use for anchorage to lightweight-aggregate concrete or for slabs less than 4 inches (100 mm) thick.
 6. To Light Steel: Sheet metal screws.
 7. Items Mounted on Hollow Walls and Nonstructural Building Surfaces: Mount cabinets, panelboards, disconnect switches, control enclosures, pull and junction boxes, transformers, and other devices on slotted-channel racks attached to substrate.
- D. Drill holes for expansion anchors in concrete at locations and to depths that avoid reinforcing bars.

3.3 INSTALLATION OF FABRICATED METAL SUPPORTS

- A. Cut, fit, and place miscellaneous metal supports accurately in location, alignment, and elevation to support and anchor electrical materials and equipment.
- B. Field Welding: Comply with AWS D1.1/D1.1M.

3.4 CONCRETE BASES

- A. Construct concrete bases of dimensions indicated but not less than 4 inches (100 mm) larger in both directions than supported unit, and so anchors will be a minimum of 10 bolt diameters from edge of the base.
- B. Use 3000-psi (20.7-MPa), 28-day compressive-strength concrete.
- C. Anchor equipment to concrete base.
1. Place and secure anchorage devices. Use supported equipment manufacturer's setting drawings, templates, diagrams, instructions, and directions furnished with items to be embedded.
 2. Install anchor bolts to elevations required for proper attachment to supported equipment.

SPECIAL PROVISIONS

3. Install anchor bolts according to anchor-bolt manufacturer's written instructions.

3.5 PAINTING

1. Touchup: Clean field welds and abraded areas of shop paint. Paint exposed areas immediately after erecting hangers and supports. Use same materials as used for shop painting. Comply with SSPC-PA 1 requirements for touching up field- painted surfaces.
 2. Apply paint by brush or spray to provide minimum dry film thickness of 2.0 mils (0.05 mm).
- B. Galvanized Surfaces: Clean welds, bolted connections, and abraded areas and apply galvanizing-repair paint to comply with ASTM A 780.

END OF SECTION

SECTION 16075 – ELECTRICAL IDENTIFICATION

PART 1 - GENERAL

1.1 RELATED DOCUMENTS

- A. Drawings and general provisions of the Contract, including General and Supplementary Conditions and Division 01 Specification Sections, apply to this Section.

1.2 SUMMARY

- A. Section Includes:
1. Identification for conductors.
 2. Underground-line warning tape.
 3. Miscellaneous identification products.

1.3 QUALITY ASSURANCE

- A. Comply with ANSI A13.1 and IEEE C2.
- B. Comply with NFPA 70.
- C. Comply with 29 CFR 1910.144 and 29 CFR 191.145
- D. Comply with ANSI Z535.4 for safety signs and labels.

SPECIAL PROVISIONS

- E. Adhesive-attached labeling materials, including label stocks, laminating adhesives, and inks used by label printers, shall comply with UL 969.

PART 2 - PRODUCTS

2.1 CONDUCTOR IDENTIFICATION MATERIALS

- A. Color-Coding Conductor Tape: Colored, self-adhesive vinyl tape not less than 3 mils (0.08 mm) thick by 1 to 2 inches (25 to 50 mm) wide.
- B. Self-Adhesive, Self-Laminating Polyester Labels: Preprinted, 3-mil- (0.08-mm-) thick flexible label with acrylic pressure-sensitive adhesive that provides a clear, weather- and chemical-resistant, self-laminating, protective shield over the legend. Labels sized to fit the conductor diameter such that the clear shield overlaps the entire printed legend.
- C. Marker Tapes: Vinyl or vinyl-cloth, self-adhesive wraparound type, with circuit identification legend machine printed by thermal transfer or equivalent process.
- D. Write-On Tags: Polyester tag, 0.015 inch (0.38 mm) thick, with corrosion-resistant grommet and cable tie for attachment to conductor or cable.
- E. Labels for Tags: Self-adhesive label, machine-printed with permanent, waterproof, black ink recommended by printer manufacturer, sized for attachment to tag.

2.2 UNDERGROUND-LINE WARNING TAPE

- A. Tape:
 - 1. Recommended by manufacturer for the method of installation and suitable to identify and locate underground electrical utility lines.
 - 2. Printing on tape shall be permanent and shall not be damaged by burial operations.
 - 3. Tape material and ink shall be chemically inert, and not subject to degrading when exposed to acids, alkalis, and other destructive substances commonly found in soils.

2.3 CABLE TIES

- A. UV-Stabilized Cable Ties: Fungus inert, designed for continuous exposure to exterior sunlight, self-extinguishing, one piece, self-locking, Type 6/6 nylon.

SPECIAL PROVISIONS

1. Minimum Width: 3/16 inch (5 mm)
2. Tensile Strength at 73 deg F (23 deg C), According to ASTM D 638: 12,000 psi (82.7 MPa).
3. Temperature Range: Minus 40 to plus 185 deg F (Minus 40 to plus 85 deg
4. Color: Black.

PART 3 - EXECUTION

3.1 INSTALLATION

- A. Verify identity of each item before installing identification products.
- B. Apply identification devices to surfaces that require finish after completing finish work.
- C. Self-Adhesive Identification Products: Clean surfaces before application, using materials and methods recommended by manufacturer of identification device.
- D. Cable Ties: For attaching tags. Use UV-stabilized nylon.
- E. Underground-Line Warning Tape: During backfilling of trenches install continuous underground-line warning tape directly above line at 6 to 8 inches (150 to 200 mm) below finished grade. Use multiple tapes where width of multiple lines installed in a common trench or concrete envelope exceeds 16 inches (400 mm) overall.

3.2 IDENTIFICATION SCHEDULE

- A. Power-Circuit Conductor Identification, 600 V or Less: For conductors in vaults, pull and junction boxes, and handholes, use color-coding conductor tape to identify the phase.
- B. Color-Coding for Phase and Voltage Level Identification, 600 V or Less: Use colors listed below for ungrounded conductors.
 - a. Color shall be factory applied or field applied for sizes larger than No. 8 AWG, if authorities having jurisdiction permit.
 - b. Colors for 208/120-V Circuits:
 - 1) Phase A: Black.
 - 2) Phase B: Red.
 - 3) Phase C: Blue.
 - c. Colors for 480/120-V Circuits:
 - 1) Phase A: Brown.

SPECIAL PROVISIONS

- 2) Phase B: Orange.
 - 3) Phase C: Yellow.
- C. Locations of Underground Lines: Identify with underground-line warning tape for lighting wiring.

END OF SECTION

Add the following Section:

SECTION 16120 - CONDUCTORS AND CABLES

PART 1 - GENERAL

1.1 RELATED DOCUMENTS

- A. Drawings and general provisions of the contract, including General and Supplementary Conditions and Division 1 Specification Sections, apply to this Section.

1.2 SUMMARY

- A. This Section includes building wires and cables and associated connectors, splices, and terminations for wiring systems rated 600 V and less.

1.3 SUBMITTALS

- A. Catalog cut sheets for all products used.

1.4 QUALITY ASSURANCE

- A. Testing Agency Qualifications: In addition to requirements specified in Division 1 Section "Quality Control," an independent testing agency shall meet OSHA criteria for accreditation of testing laboratories, Title 29, Part 1907; or shall be a full-member company of the International Electrical Testing Association.
 - 1. Testing Agency's Field Supervisor: Person currently certified by the International Electrical Testing Association or the National Institute for Certification in Engineering Technologies, to supervise on-site testing specified in Part 3.
- B. Listing and Labeling: Provide wires and cables specified in this Section that are listed and labeled.
 - 1. The Terms "Listed" and "Labeled": As defined in NFPA 70, Article 100.

SPECIAL PROVISIONS

2. Listing and Labeling Agency Qualifications: A "Nationally Recognized Testing Laboratory" as defined in OSHA Regulation 1910.7.

C. Comply with NFPA 70.

1.5 DELIVERY, STORAGE, AND HANDLING

A. Deliver wires and cables according to NEMA WC 26.

1.6 COORDINATION

A. Coordinate layout and installation of cables with other installations.

B. Revise locations and elevations from those indicated, as required to suit field conditions and as approved by ENGINEER.

PART 2 - PRODUCTS

2.1 MANUFACTURERS

A. Available Manufacturers: Subject to compliance with requirements, manufacturers offering products that may be incorporated into the WORK include, but are not limited to, the following:

1. Wires and Cables:

- a. American Insulated Wire Corp.; Leviton Manufacturing Co.
- b. Carol Cable Co., Inc.
- c. Southwire Company.

2. Connectors for Wires and Cables:

- a. AMP Incorporated.
- b. General Signal; O-Z/Gedney Unit.
- c. Monogram Co.; AFC.
- d. Square D Co.; Anderson.
- e. 3M Company; Electrical Products Division.

2.2 BUILDING WIRES AND CABLES

A. UL-listed building wires and cables with conductor material, insulation type, cable construction, and rating as specified in Part 3 "Wire and Insulation Applications" Article.

B. Rubber Insulation Material: Comply with NEMA WC 3.

C. Thermoplastic Insulation Material: Comply with NEMA WC 5.

D. Cross-Linked Polyethylene Insulation Material: Comply with NEMA WC 7.

SPECIAL PROVISIONS

- E. Ethylene Propylene Rubber Insulation Material: Comply with NEMA WC 8.
- F. Conductor Material: Copper.
- G. Stranding: Solid conductor for No. 10 AWG and smaller; stranded conductor for larger than No. 10 AWG.

2.3 CONNECTORS AND SPLICES

- A. UL-listed, factory-fabricated wiring connectors of size, ampacity rating, material, type, and class for application and service indicated. Comply with Project's installation requirements and as specified in Part 3 "Wire and Insulation Applications" Article.

PART 3 - EXECUTION

3.1 EXAMINATION

- A. Examine raceways and building finishes to receive wires and cables for compliance with requirements for installation tolerances and other conditions affecting performance of wires and cables. Do not proceed with installation until unsatisfactory conditions have been corrected.

3.2 WIRE AND INSULATION APPLICATIONS

- A. Underground: Type RHW or XHHW, in raceway. Provide cable where shown.
- B. Feeders: Type XHHW, in raceway.
- C. Branch Circuits: Type XHHW, in raceway.
- D. Class 1 Control Circuits: Type XHHW, in raceway.
- E. Class 2 Control Circuits: Type XHHW, in raceway.

3.3 INSTALLATION

- A. Install wires and cables as indicated, according to manufacturer's written instructions and NECA's "Standard of Installation."
- B. Remove existing wires from raceway before pulling in new wires and cables.
- C. Pull Conductors: Use manufacturer-approved pulling compound or lubricant where necessary; compound used must not deteriorate conductor or insulation. Do not

SPECIAL PROVISIONS

exceed manufacturer's recommended maximum pulling tensions and sidewall pressure values.

- D. Use pulling means, including fish tape, cable, rope, and basket-weave wire/cable grips that will not damage cables or raceway.
- E. Support cables according to Division 16 Section 16050 - Basic Electrical Materials and Methods.
- F. Identify wires and cables according to Division 16 Section 16050 - Basic Electrical Materials and Methods.

3.4 CONNECTIONS

- A. Conductor Splices: Keep to minimum. In underground circuits, the only splices shall be in the electrical service equipment, panels, or wall mounted enclosures.
- B. Install splices and tapes that possess equivalent or better mechanical strength and insulation ratings than conductors being spliced.
- C. Use splice and tap connectors compatible with conductor material.
- D. Wiring at Outlets: Install conductor at each outlet, with at least 12 inches (300 mm) of slack.
- E. Connect outlets and components to wiring and to ground as indicated and instructed by manufacturer.
- F. Tighten electrical connectors and terminals according to manufacturer's published torque-tightening values. If manufacturer's torque values are not indicated, use those specified in UL 486A and UL 486B.

3.5 FIELD QUALITY CONTROL

- A. Testing: On installation of wires and cables and before electrical circuitry has been energized, demonstrate product capability and compliance with requirements.
 - 1. Procedures: Perform each visual and mechanical inspection.
- B. Correct malfunctioning conductors and cables at Project site, where possible, and retest to demonstrate compliance; otherwise, remove and replace with new units and retest.

END OF SECTION

Add the following Section:

SPECIAL PROVISIONS

SECTION 16130 - RACEWAYS AND BOXES

PART 1 - GENERAL

1.1 RELATED DOCUMENTS

- A. Drawings and general provisions of the Contract, including General and Supplementary Conditions and Division 1 Specification Sections, apply to this Section.

1.2 SUMMARY

- A. This Section includes raceways, fittings, boxes, enclosures, and cabinets for electrical wiring.
 - 1. Raceways include the following:
 - a. RMC.
 - b. IMC.
 - c. EMT.
 - d. FMC.
 - e. LFNC.
 - f. RNC.
 - 2. Boxes, enclosures, and cabinets include the following:
 - a. Device boxes.
 - b. Outlet boxes.
 - c. Pull and junction boxes.
 - d. Cabinets and hinged-cover enclosures.
- B. Related Sections include the following:
 - 1. Division 16 Section 16050 - Basic Electrical Materials and Methods for raceways and box supports.

1.3 DEFINITIONS

- A. EMT: Electrical metallic tubing.
- B. FMC: Flexible metal conduit.
- C. IMC: Intermediate metal conduit.
- D. LFNC: Liquidtight flexible non-metallic conduit.
- E. RMC: Rigid metal conduit.

SPECIAL PROVISIONS

F. RNC: Rigid non-metallic conduit.

1.4 SUBMITTALS

A. Product Data: For raceways and fittings, boxes, hinged-cover enclosures, and cabinets.

1.5 QUALITY ASSURANCE

A. Listing and Labeling: Provide raceways and boxes specified in this Section that are listed and labeled.

1. The Terms "Listed" and "Labeled": As defined in NFPA 70, Article 100.

2. Listing and Labeling Agency Qualifications: A "Nationally Recognized Testing Laboratory" as defined in OSHA Regulation 1910.7.

B. Comply with NECA's "Standard of Installation."

C. Comply with NFPA 70.

1.6 COORDINATION

A. Coordinate layout and installation of raceways and boxes with other construction elements to ensure adequate headroom, working clearance, and access.

PART 2 - PRODUCTS

2.1 MANUFACTURER

A. Available Manufacturers: Subject to compliance with requirements, manufacturers offering products that may be incorporated into the WORK include, but are not limited to, the following:

1. Metal Conduit and Tubing:

- a. Carol Cable Co., Inc.
- b. Grinnell Co.; Allied Tube and Conduit Div.
- c. Monogram Co.; AFC.
- d. Triangle PWC, Inc.

2. Non-metallic Conduit and Tubing:

- a. Duraline.

3. Conduit Bodies and Fittings:

- a. American Electric; Construction Materials Group.
- b. Crouse-Hinds; Div. of Cooper Industries.
- c. Emerson Electric Co.; Appleton Electric Co.
- d. Hubbell, Inc.; Killark Electric Manufacturing Co.

SPECIAL PROVISIONS

- e. Lamson & Sessions; Carlon Electrical Products.
 - f. O-Z/Gedney; Unit of General Signal.
 - g. ETCO Speciality Products, Inc.
4. Boxes, Enclosures, and Cabinets:
- a. Butler Manufacturing Co.; Walker Division.
 - b. Crouse-Hinds; Div. of Cooper Industries.
 - c. Hoffman Engineering Co.; Federal-Hoffman, Inc.
 - d. O-Z/Gedney; Unit of General Signal.
 - e. Robroy Industries, Inc.; Electrical Division.
 - f. Thomas & Betts Corp.

2.2 METAL CONDUIT AND TUBING

- A. Rigid Steel Conduit: ANSI C80.1.
- B. IMC: ANSI C80.6.
- C. EMT and Fittings: ANSI C80.3.
 - 1. Fittings: Set-screw or compression type.
- D. FMC: Zinc-coated steel.
- E. Fittings: NEMA FB 1; compatible with conduit/tubing materials.

2.3 NON-METALLIC CONDUIT AND TUBING

- A. RNC: Schedule 40 PVC or Schedule 80 PVC per NEMA TC 2 or HDPE Conduit per ASTM D2447-95. The HDPE conduit shall have a wall thickness of at least 0.154 inches + 0.020 inches. The conduit shall be cooled to room temperature after manufacture and prior to being rolled on a spool. Provide a conduit straightening mechanism to remove the “reel memory” from the conduit prior to installation. Instead of using a conduit straightening mechanism, the conduit shall be spooled out on the ground and allowed to “relax” for at least 24 hours prior to being placed in the trench. If the conduit still has peaks and valleys, it shall be straightened.
- B. RNC Fittings: Double E-Loc Couplings. The couplings shall be friction-fit, water-tight with an elastomeric seal inside a Schedule 80 PVC shell. The seal shall be grooved to enhance the friction fit. The couplings shall have a gripper ring and lock nut on each end. The couplings shall provide an air-tight, water tight splice. All other fittings for HDPE conduit such as elbows, threaded connectors and adapters to flexible conduit, etc. shall be rigid steel conduit. Transitions from HDPE to rigid steel conduit fittings shall be performed using rigid steel conduit and Double E-Loc couplings. Provide Double E-Loc couplings by ETCO Specialty Products, Inc. or an approved equal. Use rigid steel elbows when using PVC conduit.

SPECIAL PROVISIONS

2.4 OUTLET AND DEVICE BOXES

- A. Sheet Metal Boxes: NEMA OS 1.
- B. Cast-Metal Boxes: NEMA FB 1, Type FD, cast box with gasket cover.
- C. Nonmetallic Boxes: NEMA OS 2.

2.5 PULL AND JUNCTION BOXES

- A. Small Sheet Metal Boxes: NEMA OS 1.
- B. Cast-Metal Boxes: NEMA FB 1, malleable iron with gasket cover.
- C. All boxes installed outside of any building interior shall be hot-dipped galvanized cast steel boxes.

2.6 ENCLOSURES AND CABINETS

- A. Hinged-Cover Enclosures: NEMA 250, Type 1, with continuous hinge cover and flush latch.
 - 1. Metal Enclosures: Steel, finished inside and out with manufacturer's standard enamel.
- B. Exterior: NEMA 4X. All enclosures and cabinets mounted outside shall be NEMA 4X, stainless steel, unless otherwise noted.

PART 3 - EXECUTION

3.1 EXAMINATION

- A. Examine surfaces to receive raceways, boxes, enclosures, and cabinets for compliance with installation tolerances and other conditions affecting performance of raceway installation. Do not proceed with installation until unsatisfactory conditions have been corrected.

3.2 WIRING METHODS

- A. Outdoors: Use the following wiring methods:
 - 1. Exposed: Schedule 80 PVC.
 - 2. Underground: Schedule 80 PVC within 10' of light pole foundations, type 1A junction boxes, and concrete structures. Schedule 80 PVC under all road

SPECIAL PROVISIONS

crossings. Schedule 40 PVC all other locations. Rigid Steel Conduit elbows shall be used for all 90's.

3. Boxes and Enclosures: NEMA 250, Type 4, stainless steel or hot dipped galvanized.

3.3 INSTALLATION

- A. Install raceways, boxes, enclosures, and cabinets as indicated, according to manufacturer's written instructions.
- B. Complete raceway installation before starting conductor installation.
- C. Support raceways as specified in Division 16 Section 16050 - Basic Electrical Material and Methods.
- D. Use temporary closures to prevent foreign matter from entering raceways.
- E. Protect stub-ups from damage where conduits rise through slabs. Arrange so curved portion of bends is not visible above the finished slab.
- F. Make bends and offsets so ID is not reduced. Keep legs of bends in the same plane and straight legs of offsets parallel, unless otherwise indicated.
- G. Use raceway fittings compatible with raceways and suitable for use and location. For intermediate steel conduit, use threaded rigid steel conduit fittings, unless otherwise indicated.
- H. Install exposed raceways parallel to or at right angles to nearby surfaces or structural members, and follow the surface contours as much as practical.
 1. Run parallel or banked raceways together, on common supports where practical.
 2. Make bends in parallel or banked runs from same centerline to make bends parallel. Use factory elbows only where elbows can be installed parallel; otherwise, provide field bends for parallel raceways.
- I. Join raceways with fittings designed and approved for the purpose and make joints tight.
 1. Make raceway terminations tight. Use bonding bushings or wedges at connections subject to vibration. Use bonding jumpers where joints cannot be made tight.
 2. Use insulating bushings to protect conductors.
- J. Tighten set screws of threadless fittings with suitable tools.

SPECIAL PROVISIONS

- K. Terminations: Where raceways are terminated with locknuts and bushings, align raceways to enter squarely and install locknuts with dished part against the box. Where terminations are not secure with 1 locknut, use 2 locknuts: 1 inside and 1 outside the box.
- L. Where raceways are terminated with threaded hubs, screw raceways or fittings tightly into the hub so the end bears against the wire protection shoulder. Where chase nipples are used, align raceways so the coupling is square to the box and tighten the chase nipple so no threads are exposed.
- M. Install pull wires in empty raceways. Use No. 14 AWG zinc-coated steel or monofilament plastic line with not less than 200-lb (90-kg) tensile strength. Leave at least 12 inches (300 mm) of slack at each end of the pull wire.

3.4 PROTECTION

- A. Provide final protection and maintain conditions, in a manner acceptable to manufacturer and Installer that ensure coatings, finishes, and cabinets are without damage or deterioration at the time of Substantial Completion.
 - 1. Repair damage to galvanized finishes with zinc-rich paint recommended by manufacturer.
 - 2. Repair damage to paint finishes with matching touchup coating recommended by manufacturer.

3.5 CLEANING

- A. On completion of installation, including outlet fittings and devices, inspect exposed finish. Remove burrs, dirt, and construction debris and repair damaged finish, including chips, scratches, and abrasions.

END OF SECTION

- A. Internally clean devices, device outlet boxes, and enclosures. Replace stained or improperly painted wall plates or devices.

END OF SECTION

Add the following section:

SECTION 16521 - EXTERIOR LIGHTING

PART 1 - GENERAL

1.1 RELATED DOCUMENTS

SPECIAL PROVISIONS

- A. Drawings and general provisions of the contract, including General and Supplementary Conditions and Division 1 Specification Sections, apply to this Section.

1.2 SUMMARY

- A. This Section includes exterior lighting units with luminaires, lamps, ballasts, drivers, poles/support structures, and accessories.

1.3 DEFINITIONS

- A. Lighting Unit: A luminaire or an assembly of luminaires complete with a common support, including pole, post, foundation, or other structure, and mounting and support accessories.
- B. Luminaire (Light Fixture): A complete lighting device consisting of lamp(s) and ballast(s), drivers, when applicable, together with parts designed to distribute light, to position and protect lamps, and to connect lamps to power supply.

1.4 SUBMITTALS

- A. Product Data: For each type of lighting unit indicated, arranged in order of lighting unit designation. Include data on features, accessories, finishes, and the following:
 - 1. Materials and dimensions of luminaires and poles.
 - 2. Certified results of independent laboratory tests for fixtures and lamps for electrical ratings and photometric data.
 - 3. High-intensity-discharge luminaire ballasts or LED output drivers.
 - 4. Provide information on the candela and lumen output along the vertical axis for each luminaire to show compliance with the requirements on the Drawings.
- B. Shop Drawings: Anchor-bolt templates keyed to specific poles and certified by manufacturer. Shop Drawings of the poles for use by the pole fabricator.
- C. If an alternate foundation system is proposed by the CONTRACTOR, submit shop drawings and design calculations for the foundation system.
- D. Product Certificates: Signed by manufacturers of lighting units certifying that products comply with requirements.
- E. Field Test Reports: Indicate and interpret test results for compliance with performance requirements.

SPECIAL PROVISIONS

1.5 QUALITY ASSURANCE

- A. Luminaires and Accessories: Listed and labeled as defined in NFPA 70, Article 100, for their indicated use, location, and installation conditions by a testing agency acceptable to authorities having jurisdiction.
- B. Comply with ANSI C2.
- C. Comply with NFPA 70.
- D. FM Compliance: Units for hazardous locations shall be listed and labeled for indicated class and division of hazard by FM.
- E. Provide UL listed luminaries.

1.6 DELIVERY, STORAGE, AND HANDLING OF POLES

- A. Retain factory-applied pole wrappings on metal poles until just before pole installation. For all poles, handle with web fabric straps.

1.7 WARRANTY

- A. General Warranty: Special warranty specified in this Article shall not deprive OWNER of other rights OWNER may have under other provisions of the Contract Documents and shall be in addition to, and run concurrent with, other warranties made by CONTRACTOR under requirements of the Contract Documents. Provide a general warranty for all materials and workmanship for a period of three years from the date of Substantial Completion.
- B. Special Warranty: Written warranty, signed by manufacturer and Installer agreeing to replace external parts of luminaires and poles exhibiting a failure of finish as specified below. This warranty is in addition to, and not a limitation of, other rights and remedies OWNER may have under requirements of the Contract Documents.
 - 1. Protection of Metal from Corrosion: Warranty against perforation or erosion of finish due to weathering.
 - 2. Color Retention: Warranty against fading, staining, and chalking due to effects of weather and solar radiation.
 - 3. Warranty Period: Manufacturer's standard, but not less than five years from date of Substantial Completion.

1.8 EXTRA MATERIALS

- A. Furnish extra materials described below that match products installed and that are packaged with protective covering for storage and identified with labels describing contents.

SPECIAL PROVISIONS

1. Lamps: Provide one spare lamp for each luminaire.
2. Glass and Plastic Lenses, Covers, and Other Optical Parts: 1 for every 100 of each type and rating installed. Furnish at least one of each type.
3. Ballasts/Drivers: 1 for every 100 of each type and rating installed. Furnish at least one of each type.
4. Reflectors, Glare Shields, Globes and Guards: 1 for every 20 of each type and rating installed. Furnish at least one of each type.

PART 2 - PRODUCTS

2.1 MANUFACTURERS

- A. Available Products: Subject to compliance with requirements, products that may be incorporated into the Work include, but are not limited to, the products indicated on the Drawings.

2.2 LUMINAIRES

- A. Comply with IESNA RP-8 for parameters of lateral light distribution patterns indicated for luminaires.
- B. Metal Parts: Free from burrs, sharp corners, and edges.
- C. Sheet Metal Components: Corrosion-resistant aluminum, unless otherwise indicated. Form and support to prevent warping and sagging.
- D. Housings: Rigidly formed, weather- and light-tight enclosures that will not warp, sag, or deform in use. Provide filter/breather for enclosed luminaires.
- E. Doors, Frames, and Other Internal Access: Smooth operating, free from light leakage under operating conditions, and arranged to permit re-lamping without use of tools. Arrange doors, frames, lenses, diffusers, and other pieces to prevent accidental falling during re-lamping and when secured in operating position. Provide for door removal for cleaning or replacing lens. Arrange to disconnect ballast when door opens.
- F. Exposed Hardware Material: Stainless steel.
- G. Plastic Parts: No plastic parts.
- H. Reflecting Surfaces: Minimum reflectance as follows, unless otherwise indicated:
 1. White Surfaces: 85 percent.
 2. Specular Surfaces: 83 percent.
 3. Diffusing Specular Surfaces: 75 percent.

SPECIAL PROVISIONS

- I. Lenses and Refractors: Materials as indicated. Use heat- and aging-resistant, resilient gaskets to seal and cushion lens and refractor in luminaire doors.
- J. Photoelectric Relays: As follows:
 - 1. Contact Relays: Single throw, arranged to fail in the on position and factory set to turn light unit on at 1.5 to 3 fc (16 to 32 lx) and off at 4.5 to 10 fc (48 to 108 lx) with 15-second minimum time delay.
 - 2. Relay Mounting: In electrical enclosures.
- K. LED Drivers: LED lamp drivers shall meet or exceed the following requirements:
 - 1. Voltage range: 120-277V, (+/- 10%).
 - 2. Current: .35A, (+/- 5%).
 - 3. Frequency: 50/60 Hz.
 - 4. Power Factor: >90% at full load.
 - 5. THD: <20% at full load.
 - 6. Load regulation: +/- 1% from no load to full load.
 - 7. Output ripple: <10%.
 - 8. Case temperature: rated for -40° through +80°.
 - 9. Circuit Protection: Self-limited short circuit protection and overload protected.
 - 10. Fusing: Primary fused.
 - 11. Life Rating: Not less than 50,000 hours.
 - 12. Driver Current Output: Field adjustable between 350mA, 525mA, and 700mA.
- L. LED Lamps: High bright white, individual LED lamps. Quantity per the Plans. LED lamps shall meet the requirements listed below, see Plans for further requirements.
 - 1. Initial delivered lumens – thermal losses should be less than 10% when operated at a steady state at an average ambient operating temperature of 25°C, and optical losses should be less than 15%.
 - 2. Average Delivered Lumens – Average delivered lumens over 50,000 hours should be minimum of 85% of initial delivered lumens.
 - 3. Light Distribution – Specify light distribution required per the Plans and IESNA luminaire classification (LCS). Luminaire to have independent photometric test reports.
- M. Additional Requirements: As shown on the Drawings.

2.3 LUMINAIRE SUPPORT COMPONENTS

SPECIAL PROVISIONS

- A. Description: Comply with AASHTO LTS-3 for pole or other support structures, brackets, arms, appurtenances, base, and anchorage and foundation. Wind loads shall be in accordance with UBC-1997.

- B. Wind-Load Strength of Total Support Assembly: Adequate to carry support assembly plus luminaires at indicated heights above grade without failure, permanent deflection, or whipping with a basic wind speed of 90 mph and with the application of the relevant height, exposure, gust factor, and pressure coefficients. Support assembly includes pole or other support structures, brackets, arms, appurtenances, base, and anchorage and foundation.
 - 1. Strength Analysis: For each pole type and luminaire combination, multiply the actual equivalent projected area of luminaires and brackets by a factor of 1.1 to obtain the equivalent projected area to be used in pole selection strength analysis.

- C. Finish: Match finish of pole/support structure for arm, bracket, and tenon mount materials.

- D. Mountings, Fasteners, and Appurtenances: Corrosion-resistant items compatible with support components.
 - 1. Materials: Will not cause galvanic action at contact points.
 - 2. Mountings: Correctly position luminaire to provide indicated light distribution.
 - 3. Anchor Bolts, Nuts, and Washers: Hot-dip galvanized after fabrication unless stainless-steel items are indicated.
 - 4. Anchor-Bolt Template: Plywood or steel.

- E. Pole/Support Structure Bases: See Drawings.

- F. Steel Poles: Tubing complying with ASTM A 500, Grade B, carbon steel with a minimum yield of 46,000 psig (317 MPa); one-piece construction up to 30 feet (12 m) in length with access hand hole in pole wall.
 - 1. Steps: No steps.
 - 2. Intermediate Hand hole and Cable Support: Locate at midpoint of pole height. Weather tight 3-by-5-inch (76-by-127-mm) hand hole with cover provides access to internal welded attachment lug for electric cable support grip. Provide additional hand holes and cable supports as shown on the drawings.
 - 3. Cable Support Grip: Wire-mesh type with rotating attachment eye, sized for diameter of cable and rated for a minimum load equal to weight of supported cable times a 5.0 safety factor.
 - 4. Entire pole and all associated appurtenances and structures including cross arms shall be hot-dipped galvanized.
 - 5. All lighting poles shall be steel poles. No aluminum, fiberglass, composite, or concrete poles.

SPECIAL PROVISIONS

- G. Concrete for Pole Foundations: See electrical Drawings and the applicable Specification sections for all concrete & backfill WORK.

2.4 FINISHES

- A. Comply with NAAMM's "Metal Finishes Manual for Architectural and Metal Products" for recommendations for applying and designating finishes.
- B. Aluminum: Finish designations prefixed by AA comply with the system established by the Aluminum Association for designating aluminum finishes.
 - 1. Class I, Clear Anodic Finish: AA-M32C22A41 (Mechanical Finish: medium satin; Chemical Finish: etched, medium matte; Anodic Coating: Architectural Class I, clear coating 0.018 mm or thicker) complying with AAMA 607.1.
- C. Steel: Grind welds and polish surfaces to a smooth, even finish.
 - 1. Galvanized Finish: Hot-dip galvanize after fabrication to comply with ASTM A 123.
 - 2. Surface Preparation: Clean surfaces to comply with SSPC-SP 1, "Solvent Cleaning," to remove dirt, oil, grease, and other contaminants that could impair paint bond. Remove mill scale and rust, if present, from uncoated steel, complying with SSPC-SP 5/NACE No. 1, "White Metal Blast Cleaning," or SSPC-SP 8, "Pickling."
 - 3. Interior: Apply one coat of bituminous paint on interior of pole, or otherwise treat to prevent corrosion.

PART 3 - EXECUTION

3.1 INSTALLATION

- A. Concrete Foundations: Construct according to Drawings.
- B. Install poles as follows:
 - 1. Install the poles per the manufacturer's recommendations. Also conform to the following requirements as applicable.
 - 2. Use web fabric slings (not chain or cable) to raise and set poles.
 - 3. If anchor bolts are used, mount pole to foundation with leveling nuts, and tighten top nuts to torque level recommended by pole manufacturer.
 - 4. Secure poles level, plumb, and square.
 - 5. Grout void between pole base and foundation. Use non-shrinking or expanding concrete grout firmly packed in entire void space.
 - 6. Use a short piece of 1/2-inch- (13-mm-) diameter pipe to make a drain hole through grout. Arrange to drain condensation from interior of pole.

SPECIAL PROVISIONS

- C. Luminaire Attachment: Fasten to indicated structural supports.
- D. Luminaire Attachment with Adjustable Features or Aiming: Attach luminaires and supports to allow aiming for indicated light distribution.
- E. Lamp luminaires with indicated lamps according to manufacturer's written instructions. Replace malfunctioning lamps.
- F. Utility Coordination: Coordinate with local power utility to perform work as described in the plans. Utility work to be paid for by OWNER.

3.2 CONNECTIONS

- A. Ground equipment.
 - 1. Tighten electrical connectors and terminals according to manufacturer's published torque-tightening values. If manufacturer's torque values are not indicated, use those specified in UL 486A and UL 486B.
- B. Ground metal poles/support structures according to Division 16 Section 16452 – Grounding.
 - 1. Nonmetallic Poles: Ground metallic components of lighting units and foundations. Connect luminaires to grounding system with No. 6 AWG conductor.

3.3 FIELD QUALITY CONTROL

- A. Inspect each installed unit for damage. Replace damaged units.
- B. Advance Notice: Give dates and times for field tests.
- C. Provide instruments to make and record test results.
- D. Tests and Observations: Verify normal operation of lighting units after installing luminaires and energizing circuits with normal power source, and as follows:
 - 1. Measure light intensities at night if specific illumination performance is indicated. Use photometers with calibration referenced to NIST standards.
 - 2. Check intensity and uniformity of illumination.
 - 3. Check excessively noisy ballasts.
- E. Prepare a written report of tests, inspections, observations and verifications indicating and interpreting results.

SPECIAL PROVISIONS

- F. Malfunctioning Fixtures and Components: Replace or repair, then retest. Repeat procedure until units operate properly.

3.4 CLEANING AND ADJUSTING

- A. Clean units after installation. Use methods and materials recommended by manufacturer.
- B. Adjust luminaires and luminaires with adjustable lamp position to provide required light distributions and intensities.

END OF SECTION

END OF SPECIAL PROVISIONS

CITY AND BOROUGH OF JUNEAU

UNIVERSITY DRIVE LIGHTING UPGRADE

JUNEAU, ALASKA

CBJ CONTRACT NO. BE21-092

- E-01 TITLE PAGE
- E-02 SITE PLAN - DEMO
- E-03 SITE PLAN - DESIGN
- E-04 ONE LINE
- E-05 FIXTURE AND POLE DETAIL A/B
- E-06 FIXTURE AND POLE DETAIL C
- E-07 PRECAST CONCRETE FOOTING

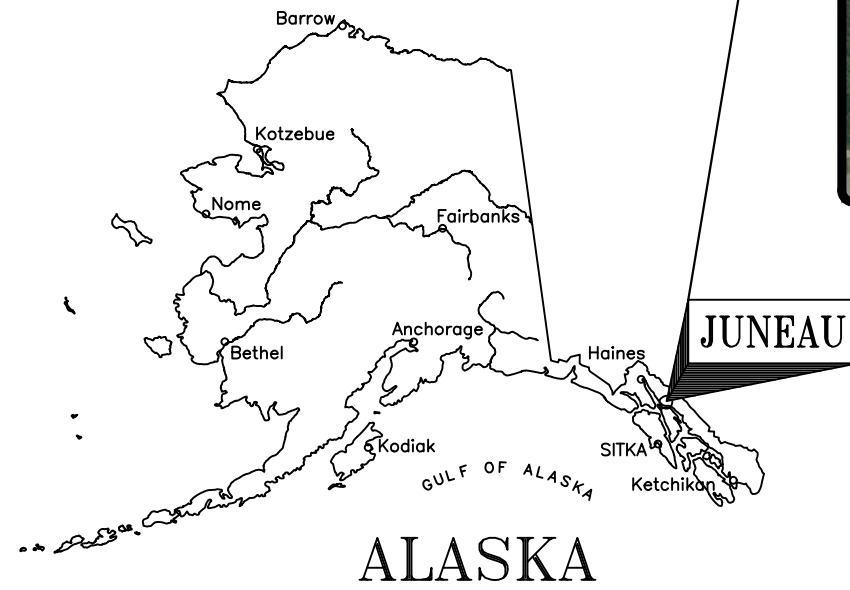
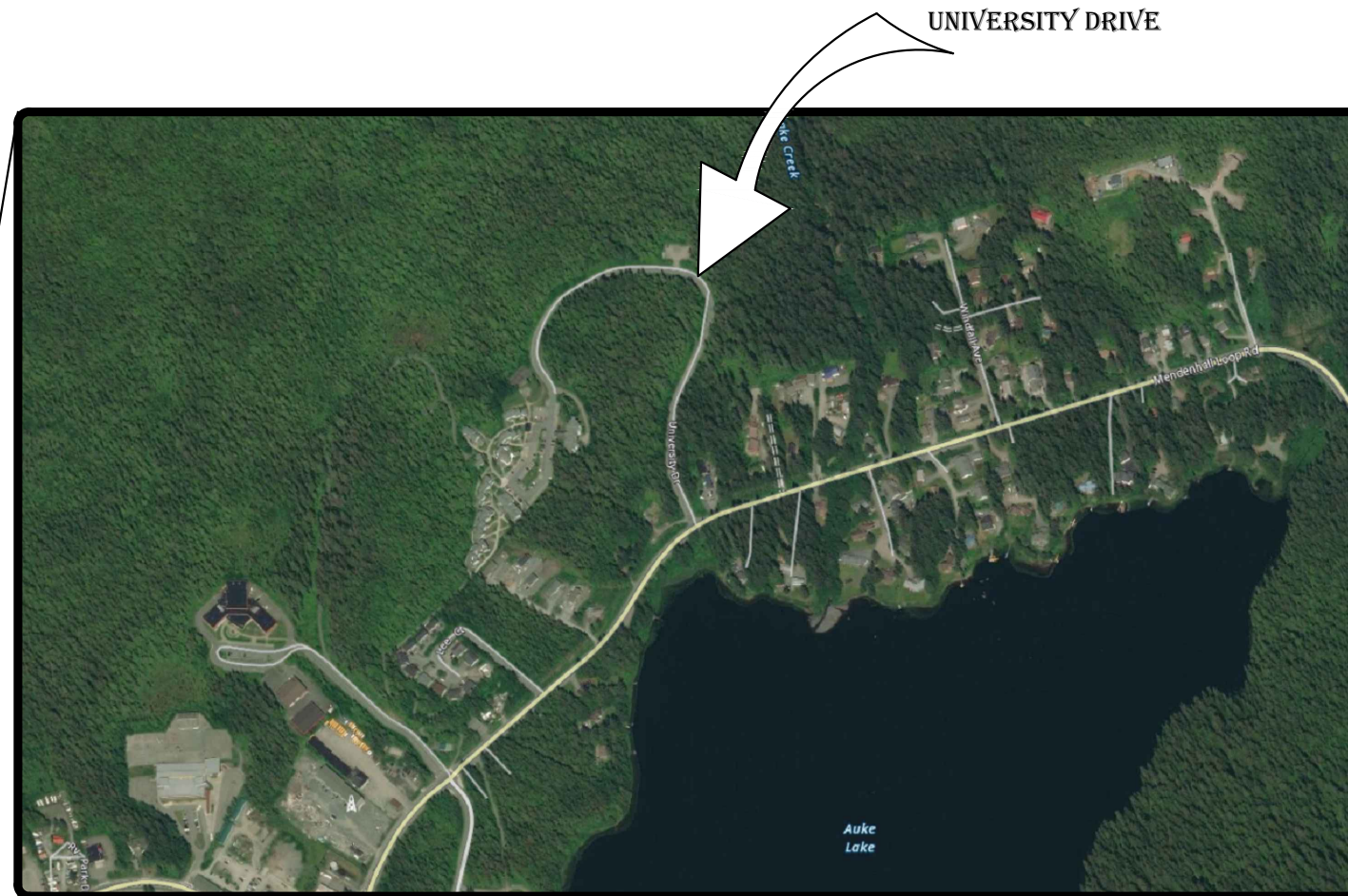

PROJECT LOCATION

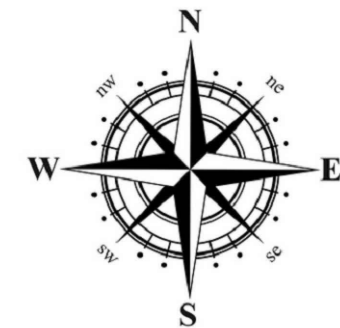
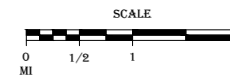

UNIVERSITY DRIVE
 LIGHTING UPGRADE
 CBJ CONTRACT No. BE21-092
 TITLE PAGE
 JUNEAU, AK

1			
2			
3			
4			
5			
6			
NO	DATE	REVISION	NO



ENGINEER: VAM CHECKED BY: VAM
 JOB #: J000180 DRAWN BY: AAM
 SCALE: N/A DATE: 10/08/20

DRAWING #:
 E-01
 SHEET
 01 OF 07

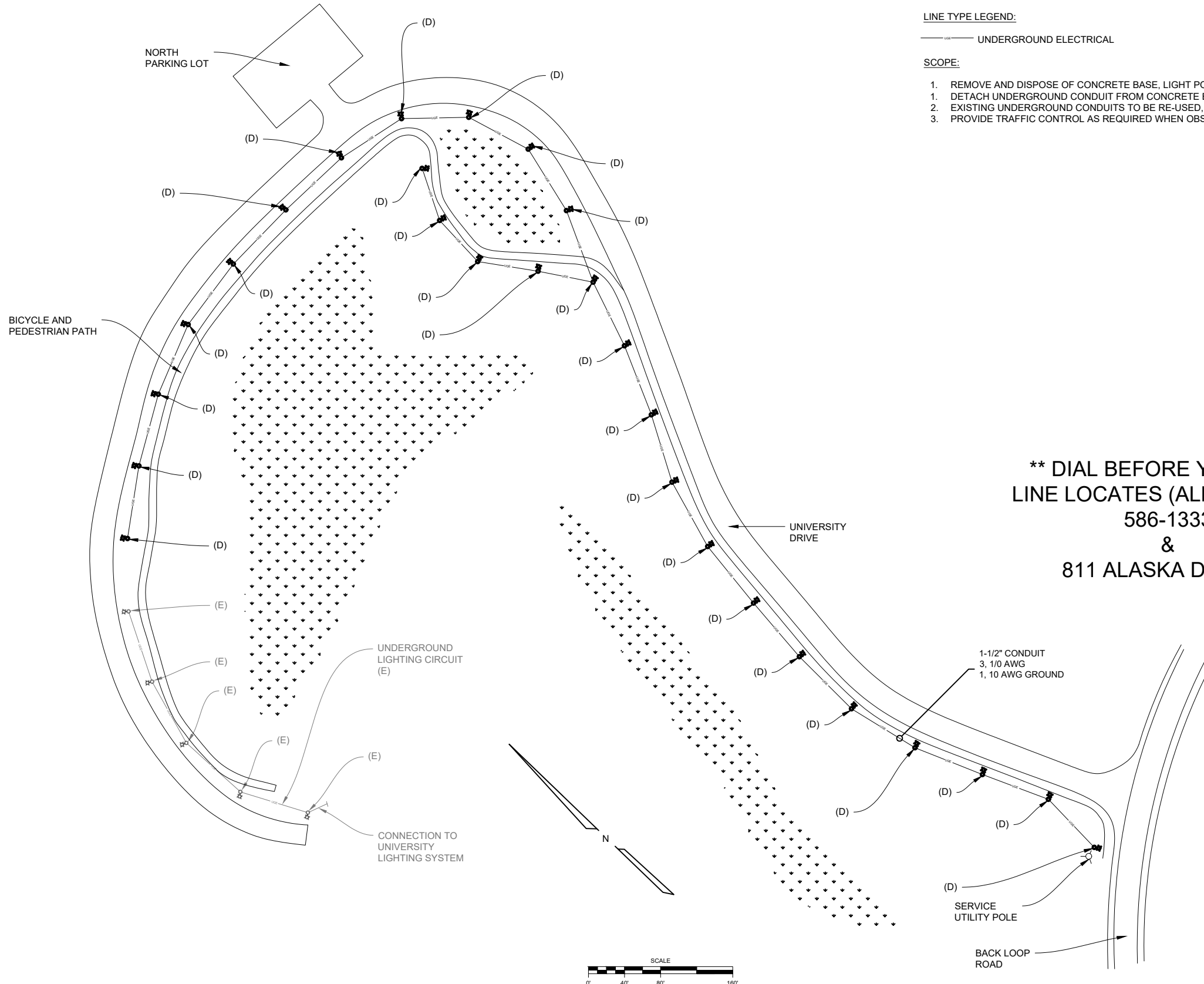

LEGEND:

- (E) - LIGHT FIXTURES OUT OF SCOPE. NO WORK IN THIS AREA.
- (D) - LIGHTING FIXTURES TO BE DEMOLISHED

LINE TYPE LEGEND:

— UNDERGROUND ELECTRICAL

SCOPE:

1. REMOVE AND DISPOSE OF CONCRETE BASE, LIGHT POLE, AND FIXTURE AS SHOWN ON DEMOLITION PLAN.
2. DETACH UNDERGROUND CONDUIT FROM CONCRETE BASE PRIOR TO REMOVAL OF BASES.
3. EXISTING UNDERGROUND CONDUITS TO BE RE-USED, TAKE CARE NOT TO DAMAGE UNDERGROUND CONDUIT WHILE REMOVING BASES.
4. PROVIDE TRAFFIC CONTROL AS REQUIRED WHEN OBSTRUCTING THE ROADWAY.

**** DIAL BEFORE YOU DIG ****
LINE LOCATES (ALL UTILITIES)
586-1333
&
811 ALASKA DIGLINE

1-1/2" CONDUIT
 3, 1/0 AWG
 1, 10 AWG GROUND

SERVICE UTILITY POLE

BACK LOOP ROAD

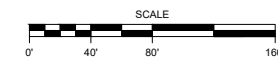

**UNIVERSITY DRIVE
 LIGHTING UPGRADE**
 CBJ CONTRACT No. BE21-092
DEMOLITION PLAN
 JUNEAU, AK

1			
2			
3			
4			
5			
6			
NO DATE	REVISION	NO	



ENGINEER:	VAM	CHECKED BY:	VAM
JOB #:	J000180	DRAWN BY:	AAM
SCALE:	N/A	DATE:	10/08/20

DRAWING #:
E-02
 SHEET
02 OF 07

1 UNIVERSITY DRIVE DEMOLITION PLAN

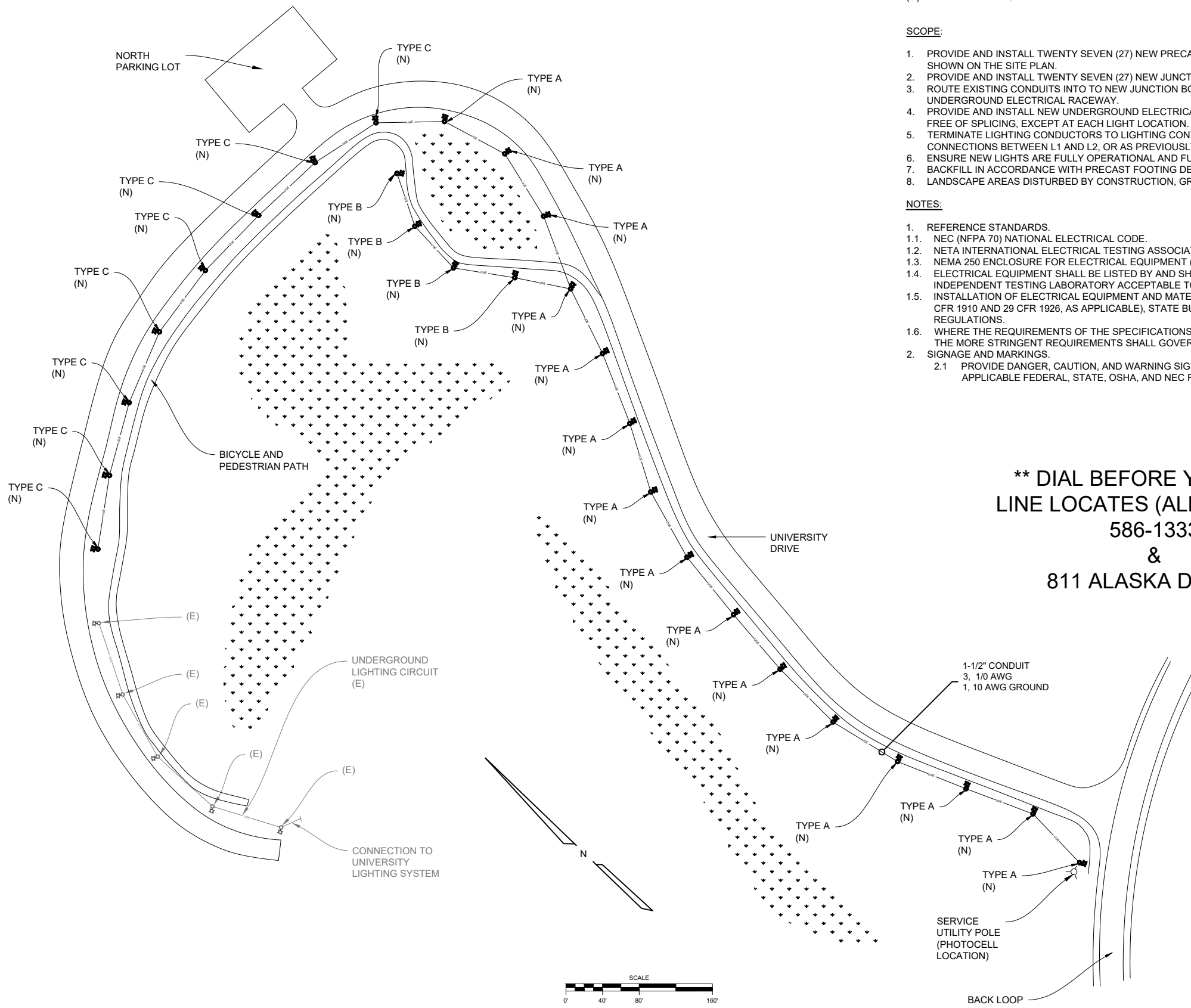

LEGEND:

- (E) - LIGHT FIXTURES OUT OF SCOPE. NO WORK IN THIS AREA.
- (N) - NEW INSTALLATION.

SCOPE:

1. PROVIDE AND INSTALL TWENTY SEVEN (27) NEW PRECAST CONCRETE BASES, LIGHT POLES, AND LIGHT FIXTURES AT THE LOCATIONS SHOWN ON THE SITE PLAN.
2. PROVIDE AND INSTALL TWENTY SEVEN (27) NEW JUNCTION BOXES AS SHOWN.
3. ROUTE EXISTING CONDUITS INTO TO NEW JUNCTION BOXES. PROVIDE CONDUIT AND FITTINGS AS NEEDED TO COMPLETE UNDERGROUND ELECTRICAL RACEWAY.
4. PROVIDE AND INSTALL NEW UNDERGROUND ELECTRICAL CONDUCTORS AS SHOWN ON SHEET E-04 ONE LINE. CONDUCTORS SHALL BE FREE OF SPLICING, EXCEPT AT EACH LIGHT LOCATION. SPLICING IS ALLOWED IN HAND HOLE ONLY.
5. TERMINATE LIGHTING CONDUCTORS TO LIGHTING CONTACTOR AS SHOWN ON LIGHT WIRE DETAIL AND ONE LINE. ALTERNATE LIGHT CONNECTIONS BETWEEN L1 AND L2, OR AS PREVIOUSLY TERMINATED.
6. ENSURE NEW LIGHTS ARE FULLY OPERATIONAL AND FUNCTION AS INTENDED PER DESIGN.
7. BACKFILL IN ACCORDANCE WITH PRECAST FOOTING DETAIL, OUTLINED ON SHEET E-06.
8. LANDSCAPE AREAS DISTURBED BY CONSTRUCTION, GRADE SOIL TO SMOOTH CONDITION. PROVIDE HYDRO SEEDING.

NOTES:

1. REFERENCE STANDARDS.
 - 1.1. NEC (NFPA 70) NATIONAL ELECTRICAL CODE.
 - 1.2. NETA INTERNATIONAL ELECTRICAL TESTING ASSOCIATION.
 - 1.3. NEMA 250 ENCLOSURE FOR ELECTRICAL EQUIPMENT (1000 VOLTS MAXIMUM).
 - 1.4. ELECTRICAL EQUIPMENT SHALL BE LISTED BY AND SHALL BEAR THE LABEL OF UNDERWRITER LABORATORIES, INC. (UL) OR AN INDEPENDENT TESTING LABORATORY ACCEPTABLE TO THE LOCAL CODE ENFORCEMENT AGENCY HAVING JURISDICTION.
 - 1.5. INSTALLATION OF ELECTRICAL EQUIPMENT AND MATERIALS SHALL COMPLY WITH OSHA SAFETY AND HEALTH STANDARDS (29 CFR 1910 AND 29 CFR 1926, AS APPLICABLE), STATE BUILDING STANDARDS, AND APPLICABLE LOCAL CODES AND REGULATIONS.
 - 1.6. WHERE THE REQUIREMENTS OF THE SPECIFICATIONS CONFLICT WITH UL, NEMA, NFPA, OR OTHER APPLICABLE STANDARDS, THE MORE STRINGENT REQUIREMENTS SHALL GOVERN.
2. SIGNAGE AND MARKINGS.
 - 2.1. PROVIDE DANGER, CAUTION, AND WARNING SIGNS AND EQUIPMENT IDENTIFICATION MARKINGS IN ACCORDANCE WITH THE APPLICABLE FEDERAL, STATE, OSHA, AND NEC REQUIREMENTS.

**** DIAL BEFORE YOU DIG ****
LINE LOCATES (ALL UTILITIES)
586-1333
&
811 ALASKA DIGLINE

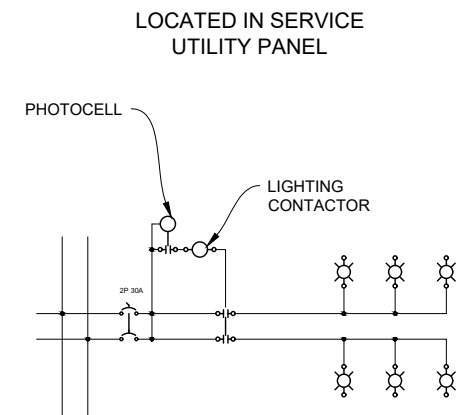

NOT TO SCALE

1 UNIVERSITY DRIVE SITE PLAN

2 LIGHT WIRING DIAGRAM



**UNIVERSITY DRIVE
 LIGHTING UPGRADE**
 CBJ CONTRACT No. BE21-092
 SITE PLAN

JUNEAU, AK

1		
2		
3		
4		
5		
6		
NO DATE	REVISION	NO



ENGINEER:	VAM	CHECKED BY:	VAM
JOB #:	J000180	DRAWN BY:	AAM
SCALE:	N/A	DATE:	10/08/20

DRAWING #:
E-03
 SHEET
03 OF 07

NOTES:

1. REPLACE LIGHTING CIRCUIT CONDUCTORS SERVICING NEW LIGHT INSTALLS. ROUTE NEW PVC CONDUIT FROM NEW CONCRETE JUNCTION BOXES TO INTERCEPT EXISTING UNIVERSITY LIGHTING PVC CONDUIT. REUSE EXISTING PVC CONDUIT UNLESS OTHERWISE DETERMINED BY OWNER AND CONTRACTOR.
2. PHOTOCELLS LOCATED ON TOP OF PANELBOARD ENCLOSURE. SHADED AREA REPRESENTS EXISTING LIGHTING EQUIPMENT SHOWN FOR INFORMATIONAL PURPOSES ONLY. NO WORK DONE IN THIS AREA.
3. SHADED AREA REPRESENTS EXISTING LIGHTING EQUIPMENT SHOWN FOR INFORMATIONAL PURPOSES ONLY. NO WORK DONE IN THIS AREA. TAKE CARE TO NOT DISTURB LIGHTING IN THIS AREA.

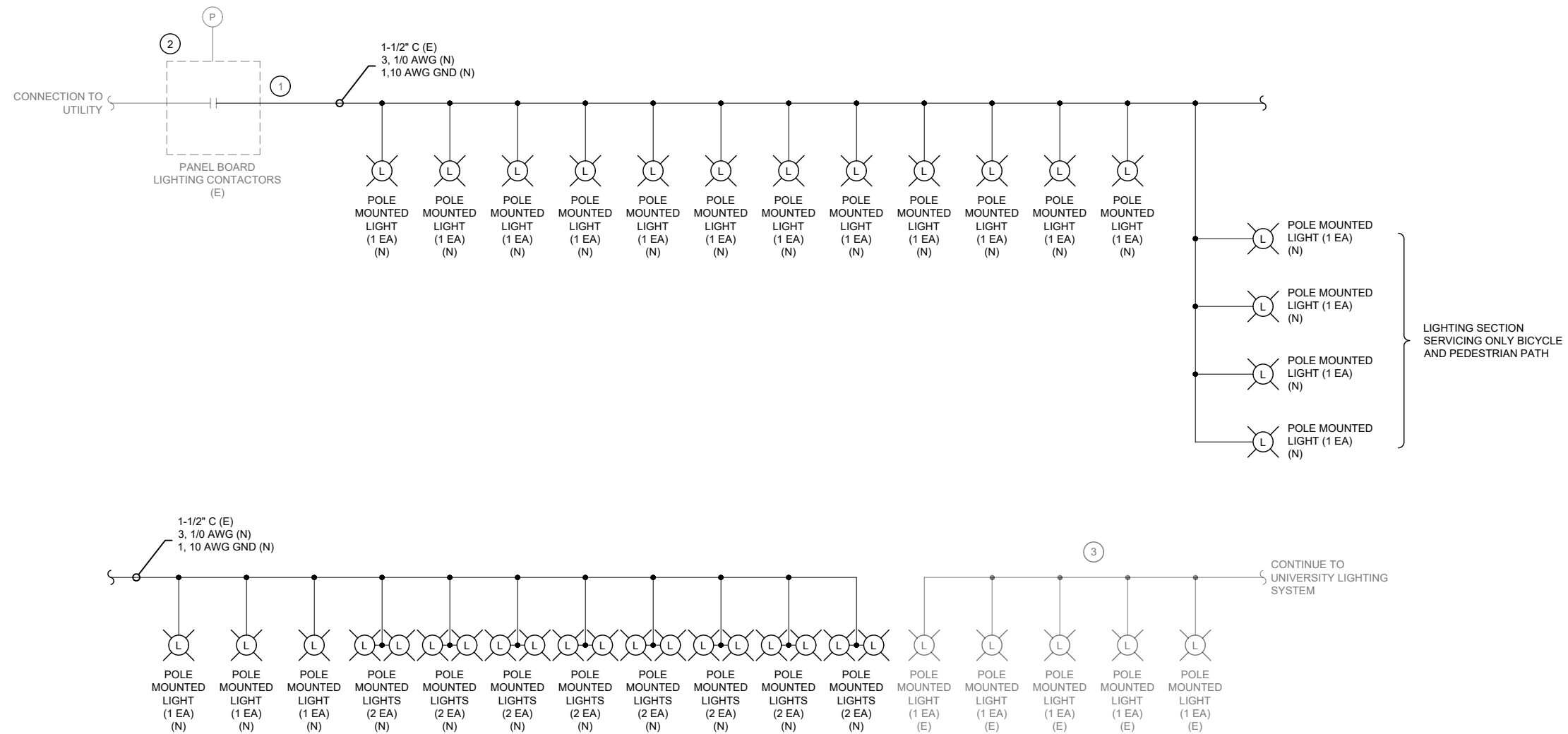

1 ONE LINE

1			
2			
3			
4			
5			
6			
NO	DATE	REVISION	NO



ENGINEER: VAM
JOB #: J000180
SCALE: N/A

CHECKED BY: VAM
DRAWN BY: AAM
DATE: 10/08/20

DRAWING #:
E-04
SHEET

04 OF 07

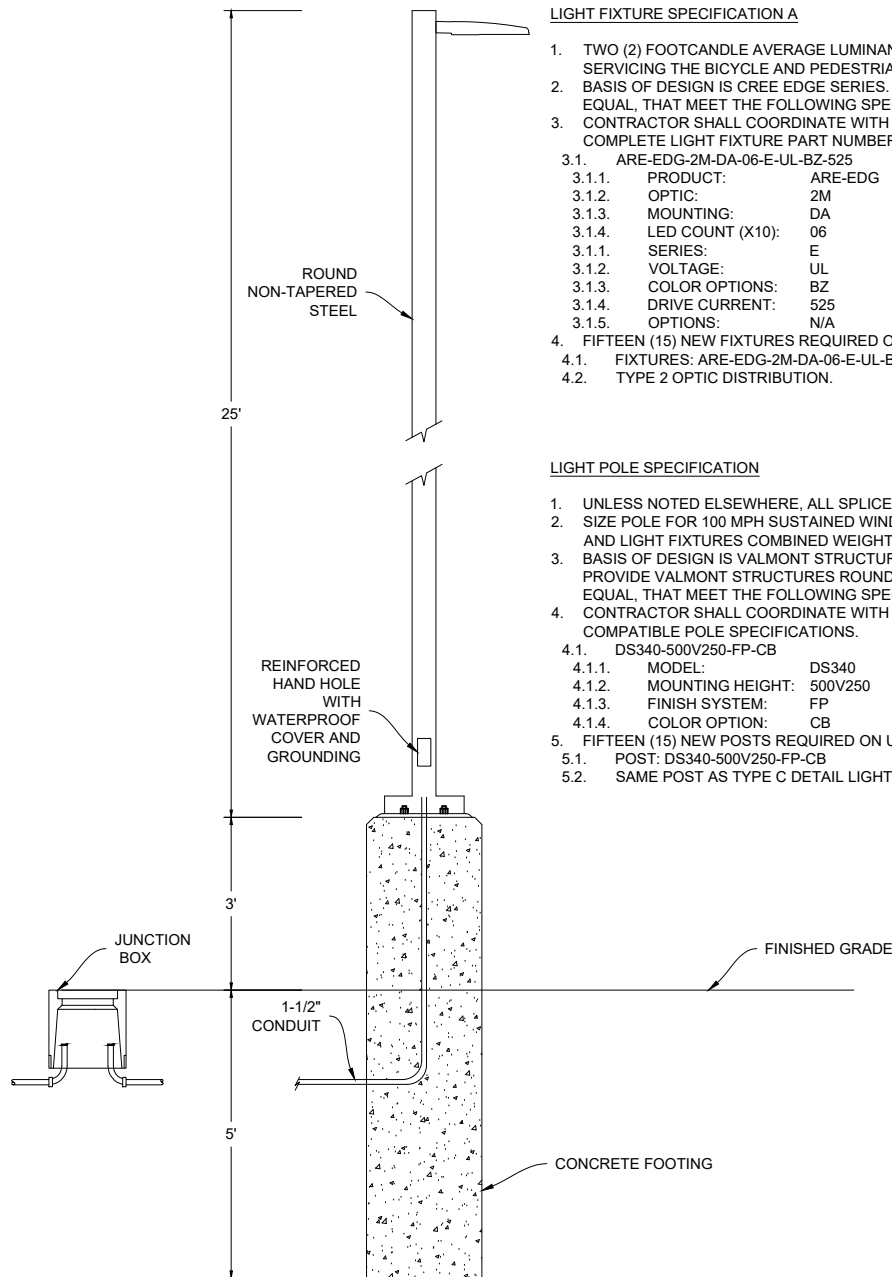

LIGHT FIXTURE SPECIFICATION A

1. TWO (2) FOOTCANDLE AVERAGE LUMINANCE REQUIREMENT ON ANY LIGHTING AREAS SERVICING THE BICYCLE AND PEDESTRIAN PATH.
2. BASIS OF DESIGN IS CREE EDGE SERIES. PROVIDE CREE EDGE SERIES, OR APPROVED EQUAL, THAT MEET THE FOLLOWING SPECIFICATIONS.
3. CONTRACTOR SHALL COORDINATE WITH OWNER AND MANUFACTURER TO PROVIDE COMPLETE LIGHT FIXTURE PART NUMBER.
 - 3.1. ARE-EDG-2M-DA-06-E-UL-BZ-525
 - 3.1.1. PRODUCT: ARE-EDG CREE EDGE SERIES
 - 3.1.2. OPTIC: 2M TYPE II MEDIUM
 - 3.1.3. MOUNTING: DA DIRECT ARM
 - 3.1.4. LED COUNT (X10): 06
 - 3.1.5. SERIES: E
 - 3.1.6. VOLTAGE: UL UNIVERSAL 120-277VAC
 - 3.1.7. COLOR OPTIONS: BZ BRONZE
 - 3.1.8. DRIVE CURRENT: 525 525mA
 - 3.1.9. OPTIONS: N/A NONE SELECTED
4. FIFTEEN (15) NEW FIXTURES REQUIRED ON UNIVERSITY DRIVE.
 - 4.1. FIXTURES: ARE-EDG-2M-DA-06-E-UL-BZ-525
 - 4.2. TYPE 2 OPTIC DISTRIBUTION.

LIGHT POLE SPECIFICATION

1. UNLESS NOTED ELSEWHERE, ALL SPLICES SHALL BE IN NEW CONCRETE JUNCTION BOX.
2. SIZE POLE FOR 100 MPH SUSTAINED WINDS WITH GUSTS TO 130 MPH WITH MAST ARM AND LIGHT FIXTURES COMBINED WEIGHT MAX OF 150 LBS.
3. BASIS OF DESIGN IS VALMONT STRUCTURES ROUND NON-TAPERED STEEL POLE. PROVIDE VALMONT STRUCTURES ROUND NON-TAPERED STEEL POLE, OR APPROVED EQUAL, THAT MEET THE FOLLOWING SPECIFICATIONS.
4. CONTRACTOR SHALL COORDINATE WITH OWNER AND MANUFACTURER TO PROVIDE COMPATIBLE POLE SPECIFICATIONS.
 - 4.1. DS340-500V250-FP-CB
 - 4.1.1. MODEL: DS340 ROUND NON-TAPERED STEEL
 - 4.1.2. MOUNTING HEIGHT: 500V250 25'-0"
 - 4.1.3. FINISH SYSTEM: FP FINISH PAINT
 - 4.1.4. COLOR OPTION: CB BRONZE
5. FIFTEEN (15) NEW POSTS REQUIRED ON UNIVERSITY DRIVE.
 - 5.1. POST: DS340-500V250-FP-CB
 - 5.2. SAME POST AS TYPE C DETAIL LIGHT POLE SPECIFICATION.

1 TYPE A FIXTURE DETAIL

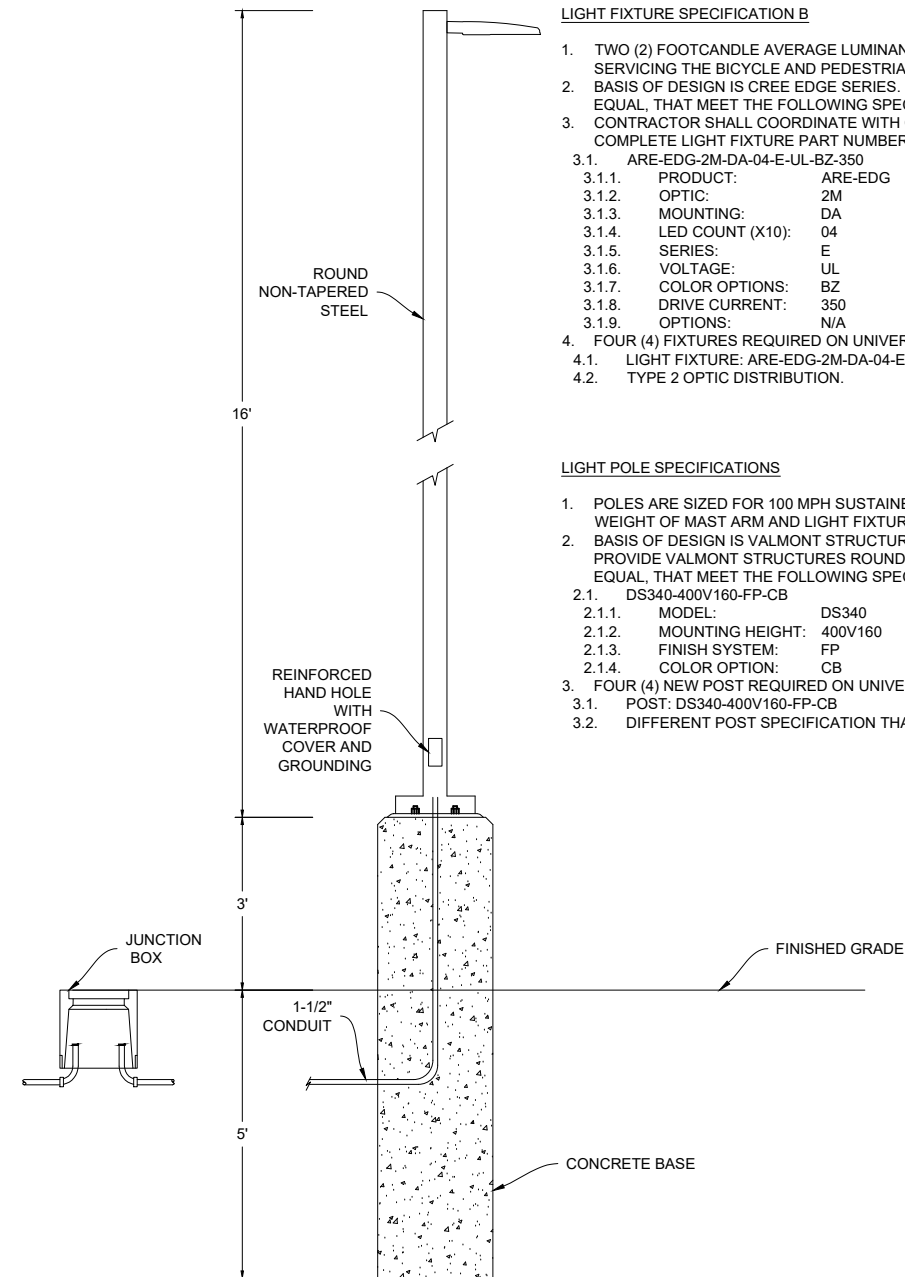

LIGHT FIXTURE SPECIFICATION B

1. TWO (2) FOOTCANDLE AVERAGE LUMINANCE REQUIREMENT ON ANY LIGHTING AREAS SERVICING THE BICYCLE AND PEDESTRIAN PATH.
2. BASIS OF DESIGN IS CREE EDGE SERIES. PROVIDE CREE EDGE SERIES, OR APPROVED EQUAL, THAT MEET THE FOLLOWING SPECIFICATIONS.
3. CONTRACTOR SHALL COORDINATE WITH OWNER AND MANUFACTURER TO PROVIDE COMPLETE LIGHT FIXTURE PART NUMBER.
 - 3.1. ARE-EDG-2M-DA-04-E-UL-BZ-350
 - 3.1.1. PRODUCT: ARE-EDG CREE EDGE SERIES
 - 3.1.2. OPTIC: 2M TYPE II MEDIUM
 - 3.1.3. MOUNTING: DA DIRECT ARM
 - 3.1.4. LED COUNT (X10): 04
 - 3.1.5. SERIES: E
 - 3.1.6. VOLTAGE: UL UNIVERSAL 120-277VAC
 - 3.1.7. COLOR OPTIONS: BZ BRONZE
 - 3.1.8. DRIVE CURRENT: 350 350mA
 - 3.1.9. OPTIONS: N/A NONE SELECTED
4. FOUR (4) FIXTURES REQUIRED ON UNIVERSITY DRIVE.
 - 4.1. LIGHT FIXTURE: ARE-EDG-2M-DA-04-E-UL-BZ-350
 - 4.2. TYPE 2 OPTIC DISTRIBUTION.

LIGHT POLE SPECIFICATIONS

1. POLES ARE SIZED FOR 100 MPH SUSTAINED WINDS WITH GUSTS TO 130 MPH. MAX WEIGHT OF MAST ARM AND LIGHT FIXTURE SHOULD NOT EXCEED 150 LBS.
2. BASIS OF DESIGN IS VALMONT STRUCTURES ROUND NON-TAPERED STEEL POLE. PROVIDE VALMONT STRUCTURES ROUND NON-TAPERED STEEL POLE, OR APPROVED EQUAL, THAT MEET THE FOLLOWING SPECIFICATIONS.
 - 2.1. DS340-400V160-FP-CB
 - 2.1.1. MODEL: DS340 ROUND NON-TAPERED STEEL
 - 2.1.2. MOUNTING HEIGHT: 400V160 16'-0"
 - 2.1.3. FINISH SYSTEM: FP FINISH PAINT
 - 2.1.4. COLOR OPTION: CB BRONZE
3. FOUR (4) NEW POST REQUIRED ON UNIVERSITY DRIVE.
 - 3.1. POST: DS340-400V160-FP-CB
 - 3.2. DIFFERENT POST SPECIFICATION THAN POLE DETAIL A AND C.

2 TYPE B FIXTURE DETAIL

1			
2			
3			
4			
5			
6			

NO DATE REVISION NO



ENGINEER: VAM CHECKED BY: VAM
 JOB #: J000180 DRAWN BY: AAM
 SCALE: N/A DATE: 10/08/20

DRAWING #: E-05
 SHEET 05 OF 07

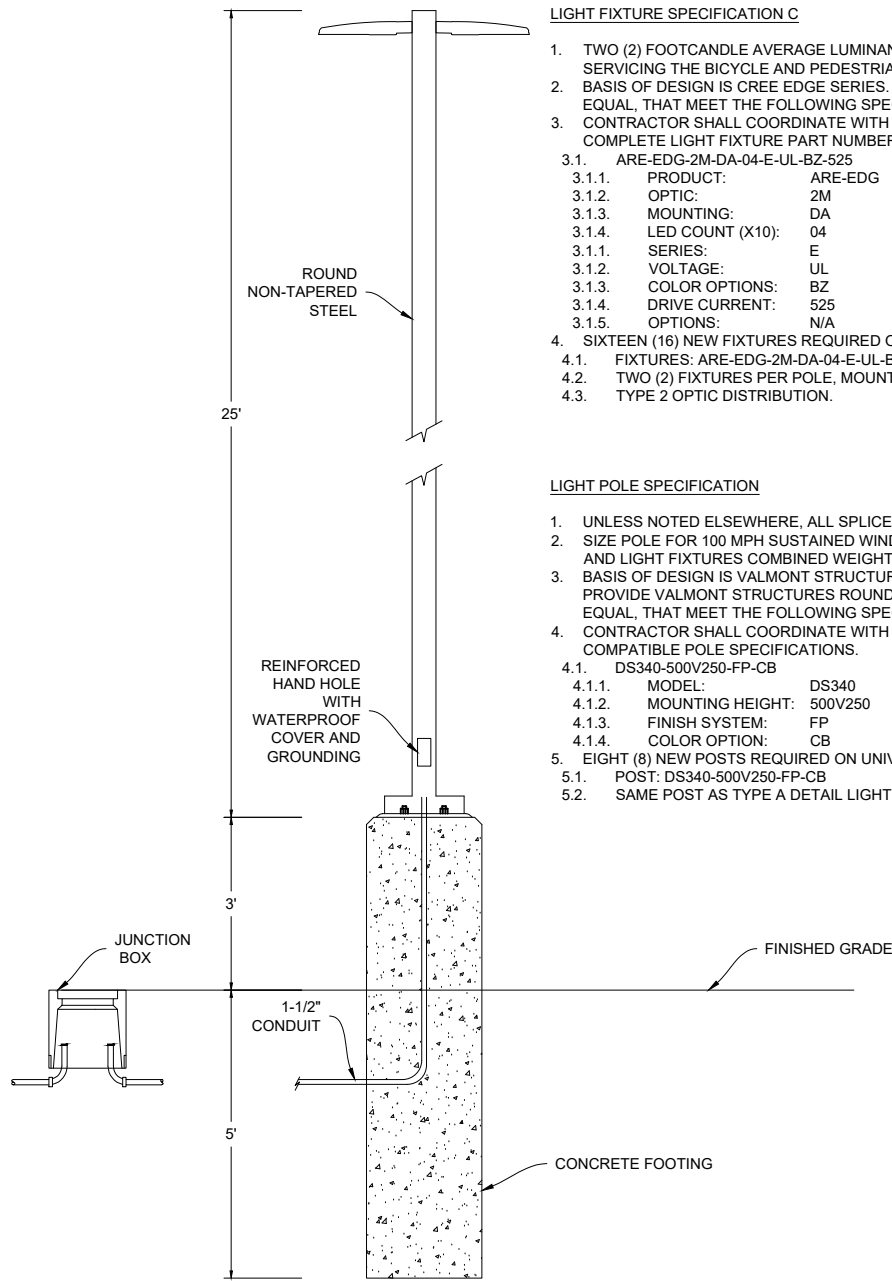

LIGHT FIXTURE SPECIFICATION C

1. TWO (2) FOOTCANDLE AVERAGE LUMINANCE REQUIREMENT ON ANY LIGHTING AREAS SERVING THE BICYCLE AND PEDESTRIAN PATH.
2. BASIS OF DESIGN IS CREE EDGE SERIES. PROVIDE CREE EDGE SERIES, OR APPROVED EQUAL, THAT MEET THE FOLLOWING SPECIFICATIONS.
3. CONTRACTOR SHALL COORDINATE WITH OWNER AND MANUFACTURER TO PROVIDE COMPLETE LIGHT FIXTURE PART NUMBER.
 - 3.1. ARE-EDG-2M-DA-04-E-UL-BZ-525
 - 3.1.1. PRODUCT: ARE-EDG CREE EDGE SERIES
 - 3.1.2. OPTIC: 2M TYPE II MEDIUM
 - 3.1.3. MOUNTING: DA DIRECT ARM
 - 3.1.4. LED COUNT (X10): 04
 - 3.1.1. SERIES: E
 - 3.1.2. VOLTAGE: UL UNIVERSAL 120-277VAC
 - 3.1.3. COLOR OPTIONS: BZ BRONZE
 - 3.1.4. DRIVE CURRENT: 525 525mA
 - 3.1.5. OPTIONS: N/A NONE SELECTED
4. SIXTEEN (16) NEW FIXTURES REQUIRED ON UNIVERSITY DRIVE.
 - 4.1. FIXTURES: ARE-EDG-2M-DA-04-E-UL-BZ-525
 - 4.2. TWO (2) FIXTURES PER POLE, MOUNTED @ 180°.
 - 4.3. TYPE 2 OPTIC DISTRIBUTION.

LIGHT POLE SPECIFICATION

1. UNLESS NOTED ELSEWHERE, ALL SPLICES SHALL BE IN NEW CONCRETE JUNCTION BOX.
2. SIZE POLE FOR 100 MPH SUSTAINED WINDS WITH GUSTS TO 130 MPH WITH MAST ARM AND LIGHT FIXTURES COMBINED WEIGHT MAX OF 150 LBS.
3. BASIS OF DESIGN IS VALMONT STRUCTURES ROUND NON-TAPERED STEEL POLE. PROVIDE VALMONT STRUCTURES ROUND NON-TAPERED STEEL POLE, OR APPROVED EQUAL, THAT MEET THE FOLLOWING SPECIFICATIONS.
4. CONTRACTOR SHALL COORDINATE WITH OWNER AND MANUFACTURER TO PROVIDE COMPATIBLE POLE SPECIFICATIONS.
 - 4.1. DS340-500V250-FP-CB
 - 4.1.1. MODEL: DS340 ROUND NON-TAPERED STEEL
 - 4.1.2. MOUNTING HEIGHT: 500V250 25'-0"
 - 4.1.3. FINISH SYSTEM: FP FINISH PAINT
 - 4.1.4. COLOR OPTION: CB BRONZE
5. EIGHT (8) NEW POSTS REQUIRED ON UNIVERSITY DRIVE.
 - 5.1. POST: DS340-500V250-FP-CB
 - 5.2. SAME POST AS TYPE A DETAIL LIGHT POLE SPECIFICATION.

1 TYPE C FIXTURE DETAIL

1			
2			
3			
4			
5			
6			
NO	DATE	REVISION	NO



ENGINEER:	VAM	CHECKED BY:	VAM
JOB #:	J000180	DRAWN BY:	AAM
SCALE:	N/A	DATE:	10/08/20

DRAWING #:
E-06
SHEET
06 OF 07

PRECAST CONCRETE FOOTING DETAIL:

1. BACKFILL WITH D-1 AROUND FOOTING, 12 INCHES ALL SIDES. COMPACT TO 95%.
2. NO. 2 REBAR SPIRAL INSTALLATION. SPIRAL SHALL HAVE 20 INCH DIAMETER WITH 1 TURN EVERY 3 INCHES. MAINTAIN MINIMUM 2" COVER.
3. PROVIDE GALVANIZED ANCHOR BOLTS AND LEVELING NUTS AS RECOMMENDED BY MANUFACTURER. SPACE ANCHOR BOLTS EVENLY WITHIN THE REBAR SPIRAL. EMBED ANCHOR BOLTS A MINIMUM OF 4 FEET INTO CONCRETE FOOTING. ENSURE ANCHOR BOLTS MATCH ANCHORING PATTERN OF NEW LIGHT POST.
4. PROVIDE NO. 8 CU GROUNDING CONDUCTOR. BOND GROUNDING CONDUCTOR TO FOOTING REBAR, ANCHOR BOLTS, LIGHT POLE, AND EQUIPMENT GROUNDING CONDUCTOR.
5. CONCRETE SHALL BE PER CITY AND BOROUGH OF JUNEAU SPEC SECTION 03302.

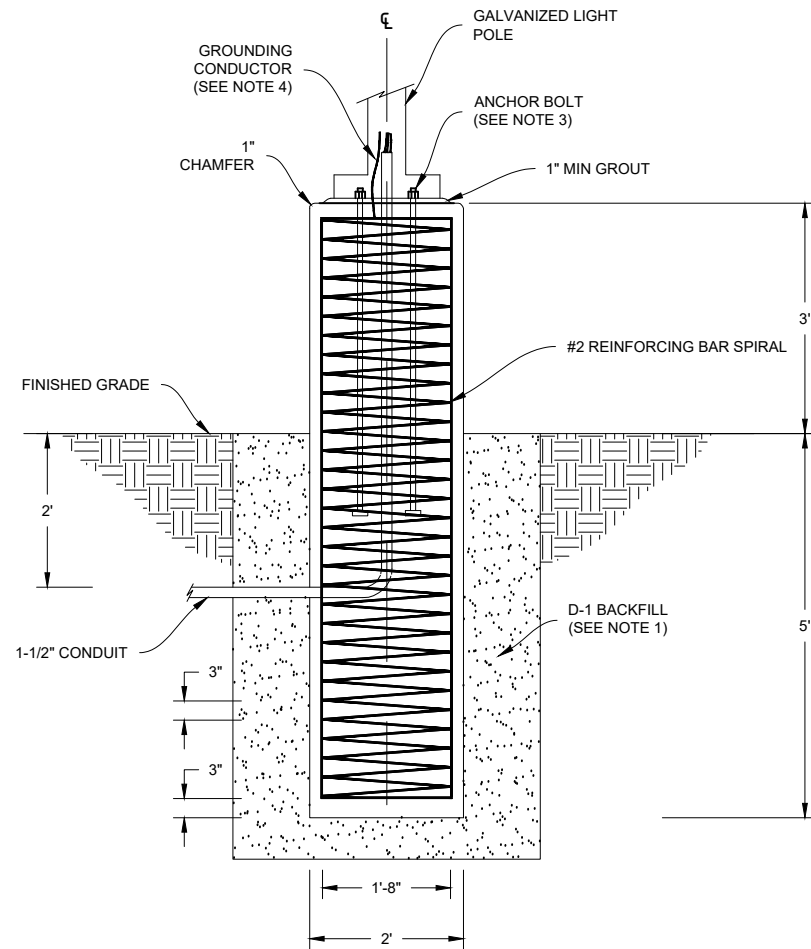

1 PRECAST CONCRETE FOOTING DETAIL

CONCRETE JUNCTION BOX DETAIL:

1. EACH COVER FOR TYPE 1 & 1A JUNCTION BOXES SHALL BE CAST IRON.
2. JUNCTION BOXES LOCATED IN A SIDEWALK SHALL BE INSTALLED WITH A 1/2" PREFORMED BITUMINOUS JOINT MATERIAL AROUND ITS PERIMETER.
3. ALL CONDUITS SHALL BE BONDED TO FORM A CONTINUOUS ELECTRICAL SECURE SYSTEM WITH THE GROUND AT THE LOAD CENTER JUNCTION BOX.
4. ALL LIDS SHALL BE GROUNDED IN ACCORDANCE WITH MANUFACTURERS INSTRUCTION, STATE, AND LOCAL CODES.
5. ALL CONDUITS SHALL BE GROUTED IN KNOCKOUT SECTIONS IN ACCORDANCE WITH THE ALASKA SPECIFICATIONS FOR HIGHWAY CONSTRUCTION, LATEST EDITION.

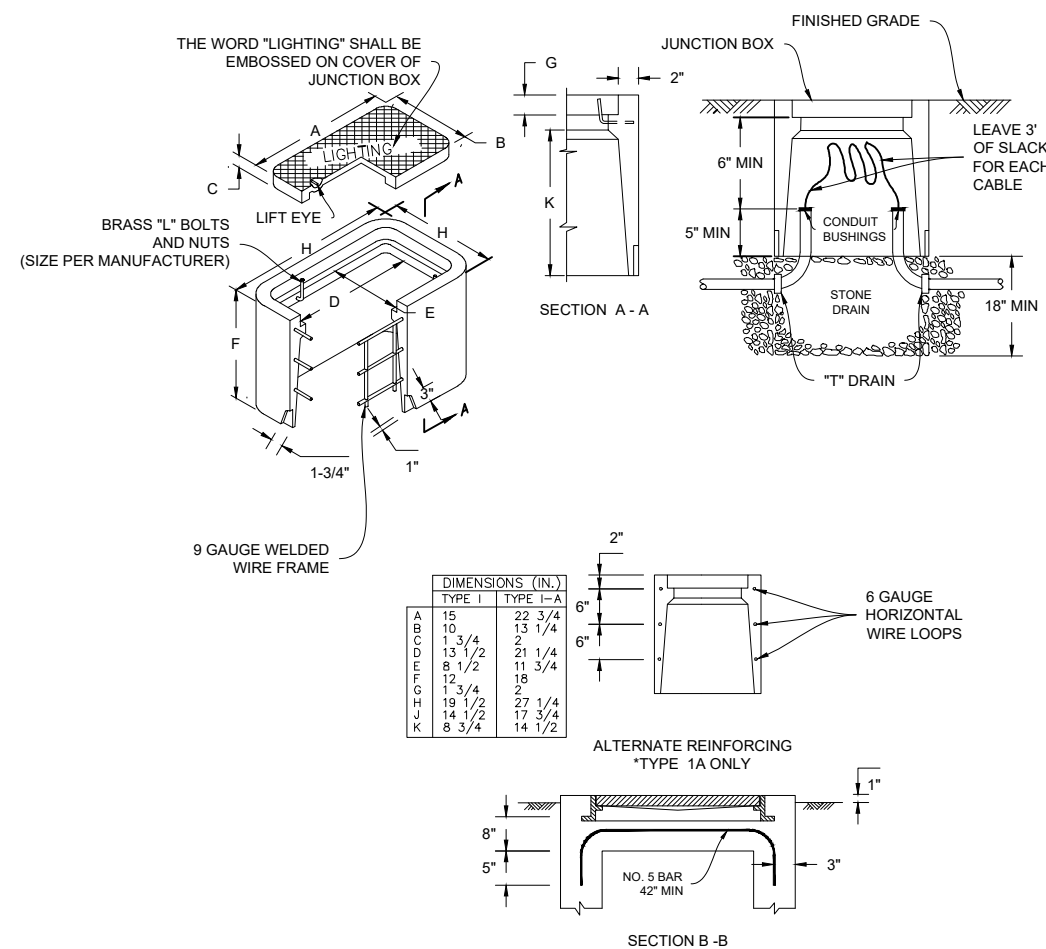

2 TYPE 1 & 1A JUNCTION BOX DETAIL



UNIVERSITY DRIVE
LIGHTING UPGRADE
CBJ CONTRACT No. BE21-092
FOOTING & JUNCTION BOX

JUNEAU, AK

1			
2			
3			
4			
5			
6			



ENGINEER: VAM
JOB #: J000180
SCALE: N/A

CHECKED BY: VAM
DRAWN BY: AAM
DATE: 10/08/20

DRAWING #:
E-07
SHEET
07 OF 07