

# Downtown Historic District Design Standards & Guidelines Juneau, Alaska



Adopted as Regulation, October 12, 2009  
(Effective October 21, 2009)



---

# Downtown Historic District Standards & Design Guidelines

## Juneau, Alaska

Prepared by:  
Winter & Company  
1265 Yellow Pine Ave  
Boulder, CO 80304  
Phone: (303) 440-8445  
Fax: (303) 443-0725  
[www.winterandcompany.net](http://www.winterandcompany.net)

---

---

# Credits

## City and Borough of Juneau Assembly

Bruce Botelho, Mayor

Jonathan Anderson

Jeff Bush

Sara Chambers

Robert Doll

Johan Dybdahl

Merrill Sanford

David Stone

Randy Wanamaker

## City and Borough of Juneau Planning Commission

Dan Bruce, Chairperson

Maria Gladziszewski

Dan Miller

Frank Rue

Michael Satre

Victor Scarano

Linda Snow

Nancy Waterman

Dennis Watson

## City and Borough of Juneau Community Development Department

Dale Pernula, Director

Greg Chaney, Planning Manager

Daniel Sexton, Historic Preservation Planner

Katie Cote, Historic Preservation Planner

## Historic Resources Advisory Committee

Gerald Gotschall, Chairperson

Monika Bethers

Christine Crooks

Marie Darlin

Gary Gillette

Myra Gilliam

S. Puanani Maunu

Graham Rountree

Steven Winker

## Downtown Business Association

*The research for this publication has been financed in part with Federal funds from the National Park Service, Department of Interior, and through the assistance of the Office of History and Archaeology, Department of Natural Resources. However, the contents and opinions do not necessarily reflect the views or policies of the Department of the Interior or the Department of Natural Resources, nor does the mention of trade names or commercial products constitute endorsement or recommendation by the Department of the Interior or Department of Natural Resources.*

---



---

# Table of Contents

Introduction	i
What are Design Guidelines?	
Why have Design Guidelines?	
Who uses the Design Guidelines?	
When to use the Design Guidelines	
Where do Design Guidelines Apply?	
Compliance with the Guidelines	
Relation to Land Use Code	
Do Design Guidelines Dictate Taste?	
Downtown Historic District Map	
Planning a Preservation Project	
Alterations	
Criteria For Replacing Historic Features	
Review Process	
How the Guidelines Apply	
Structure of the Design Guidelines	
Chapter 1. Basic Principles of Historic Preservation	1
Benefits of Preserving Historic Buildings	
Basic Principles for Non-Contributing Buildings and New Construction	
Period of Significance	
Chapter 2. The History and Character of the Downtown Historic District	7
Key Features of the Downtown Historic District	
Building Types and Styles	
Chapter 3. Design Guidelines for Rehabilitation of Historic Properties	23
Preserve	
Repair	
Replace	
Protect and Maintain Property	
Chapter 4. Design Guidelines for Historic Building Materials	27
Wood Siding	
Paint	
Concrete and Masonry	
Metals	
Cleaning Materials and Methods	
Chapter 5. Design Guidelines for Historic Building Elements	31
Windows	
Doors	
Commercial Storefronts	
Roofs	
Cornices	
Canopies and Awnings	

---

---

Chapter 5. (Continued)	
Balconies	
Rooftop Uses	
Mechanical Equipment and Service Utilities	
Chapter 6. Design Guidelines for Historic Alterations and Additions	41
Historic Additions	
Adaptive Re-Use	
New Additions to Historic Properties	
Chapter 7. Design Guidelines for New Construction	43
Placement and Orientation	
Mass, Scale and Height	
Building Materials	
Architectural Character	
Facade Elements	
Chapter 8. Design Guidelines for Site Design and the Public Streetscape	55
Cut and Fill	
Site Retaining Walls	
Building and Site Lighting	
Mechanical Equipment and Service Utilities	
Street Furnishings	
Sidewalks	
ATMs	
Chapter 9. Design Guidelines for Parking Facilities	63
Surface Parking	
Security and Pedestrian Circulation in Parking Facilities	
Parking Structures	
Chapter 10. Design Guidelines for Signs	65
Appropriate Sign Types	
Sign Composition	
Sign Character	
Sign Materials	
Sign Lighting	
Sign Installation	
Sign Color	
Chapter 11. Design Guidelines for Off-season Display Windows	71
Appendices	
A. The Secretary of Interior's Standards	
B. Historic Preservation Briefs	
C. Glossary of Terms	
D. Historic Resources Map	

---

---

# Introduction

Juneau has a vibrant history that spans several generations and is reflected in the many historic structures that survive throughout the community. Many of these are concentrated in the downtown, where they create a distinct sense of place. Here, in the heart of the community, a diverse range of older building styles represent several phases in Juneau’s evolution, provide visual interest to residents and visitors, and stand as symbols of the community’s role in the development of Southeast Alaska.

The importance of this area is recognized by the Secretary of the Interior, with a listing in the National Register of Historic Places. In addition, the City and Borough of Juneau Assembly has bestowed a local historic district designation on this part of downtown. This area is important to the community, the state and the nation. It is enjoyed by residents and visitors throughout the year, including those who work there as well as those who come to conduct business at the capitol or who visit for pleasure.

Preserving the integrity of the Downtown Historic District is a high priority for the community, because it saves a key part of Juneau’s heritage, enhances quality of life and also supports economic development. For this reason, these design guidelines are provided as a means of protecting historic resources and promoting compatible new construction within their context.

This document presents Design Guidelines for the City and Borough of Juneau’s Downtown Historic District. They offer criteria for determining the appropriateness of improvements that may be planned within the district and also to key historic resources outside it. This section provides



South Franklin Street in 1914.



1946.



2007.

A view looking north along Franklin Street, as it appeared over a ninety-three year period illustrates a moderate pace of change. Many early buildings survive, and others from the mid-Twentieth Century have also taken on historic significance. These “newer” buildings reflect their own times, in terms of style, but are compatible with their older neighbors, because they share basic similarities of design at a more fundamental level. These features are addressed in the design guidelines for new construction that appear in this document.



a general overview of the Design Guidelines framework, including a description of how to utilize the Design Guidelines, understand the format of the document and how to determine which Design Guidelines are relevant for certain project types.

## What are Design Guidelines?

Design Guidelines address alterations to existing structures, additions, new construction and site work. They define a range of appropriate responses to a variety of specific design issues.

Some of the guidelines are written specifically to be used when improving historic structures, others apply to non-contributing, existing buildings, and still others apply to completely new, “infill,” construction. (A chart on page xv indicates which projects apply to specific project categories.)



## Why have Design Guidelines?

Design Guidelines help establish a common understanding of preservation principles and standards. Retaining the historic character that exists downtown is an important goal for Juneau. The historic resources of Juneau are finite and vulnerable to inappropriate alteration and demolition. These resources are key parts of the community’s identity, livability and, through heritage tourism, its economy as well.

While they are focused on the designated Downtown Historic District, the Design Guidelines also may be applied to key historic structures outside of the district that may be designated by the City and Borough of Juneau.

## Who uses the Design Guidelines?

These Design Guidelines have been written primarily for use by the review authority. The guidelines will be used for projects within the Downtown Historic District and key historic resources outside of the district. The guidelines are also intended for use by property owners in making decisions about proposed rehabilitation and new construction projects that will be sensitive to the historic character of the district and individual landmarks.

---

## When to use the Design Guidelines

The Design Guidelines should be consulted for projects which may affect the integrity of historic resources. While ordinary repair and maintenance is appropriate, seemingly minor alterations to a historic structure, such as enclosing a storefront or changing windows, can have a dramatic effect on the character of a historic structure and therefore, are of concern. The following is a list of common changes that can have a significant impact on the integrity of a historic structure:

- Construction of a new addition
- Alteration or restoration of exterior features of a historic building
- Removal or demolition, in whole or in part, of a historic building
- Alteration of a storefront
- Application of a new exterior siding material
- Addition of a new window or door opening
- Creation of a driveway or a parking area
- Construction or addition of a parking deck
- Application of architectural features and other miscellaneous modifications, such as cornices and bulkheads.

This list is not all inclusive, but is indicative of the types of changes to which these Design Guidelines apply. For questions regarding permits and the applicability of these guidelines, please contact the City and Borough of Juneau's Community Development Department.

## Where do the Design Guidelines apply?

The Design Guidelines apply to properties within the Downtown Historic District. The boundaries of the Downtown Historic District are shown on the officially adopted Juneau Downtown Historic District map (the map on page v shows the approximate location). These guidelines are also applicable to individual historic properties outside of the historic district designated by the City and Borough of Juneau.

---

## Compliance with the Guidelines

Development within the Downtown Historic District shall comply with all of the relevant guidelines. In some cases, there may be an interaction among the relevant guidelines, in which one of them is better achieved when another is addressed with more flexibility. This will be taken into consideration in the review process. However, full compliance is required, unless it is demonstrated that it is not technically feasible to do so. In these cases, an alternative design solution may be considered, but it must be demonstrated that it meets the intent of the guidelines.

In other situations, a particular guideline may not be applicable. The City and Borough of Juneau Community Development Director will determine when a particular guideline is not applicable. Recognizing that there is an interactive quality to the guidelines, the term “should” is often used. “Should” means compliance is required unless the conditions described above are demonstrated to exist and alternative compliance is appropriately achieved.

## Relation to Land Use Code

These Downtown Historic District Design Standards and Guidelines comprise regulations adopted pursuant to CBJ 01.60 and CBJ 49.75.220. They repeal and replace the existing Historic District Standards, 04 CB-JAC 080.010 - .090. In addition to the design objectives, standards and guidelines presented here, any improvements within the district must also comply with the zoning standards set forth in the Land Use Code. If a conflict is identified within these Historic District Regulations, the more restrictive standard or guideline shall apply.

## Do Design Guidelines dictate taste?

The guidelines reflect basic approaches to design that will help preserve the historic integrity of the district. They do not dictate style, but they do require compatibility with the historic character of the district. They also reflect the values of the community, including its goals to preserve the historic buildings and character of Downtown Juneau.

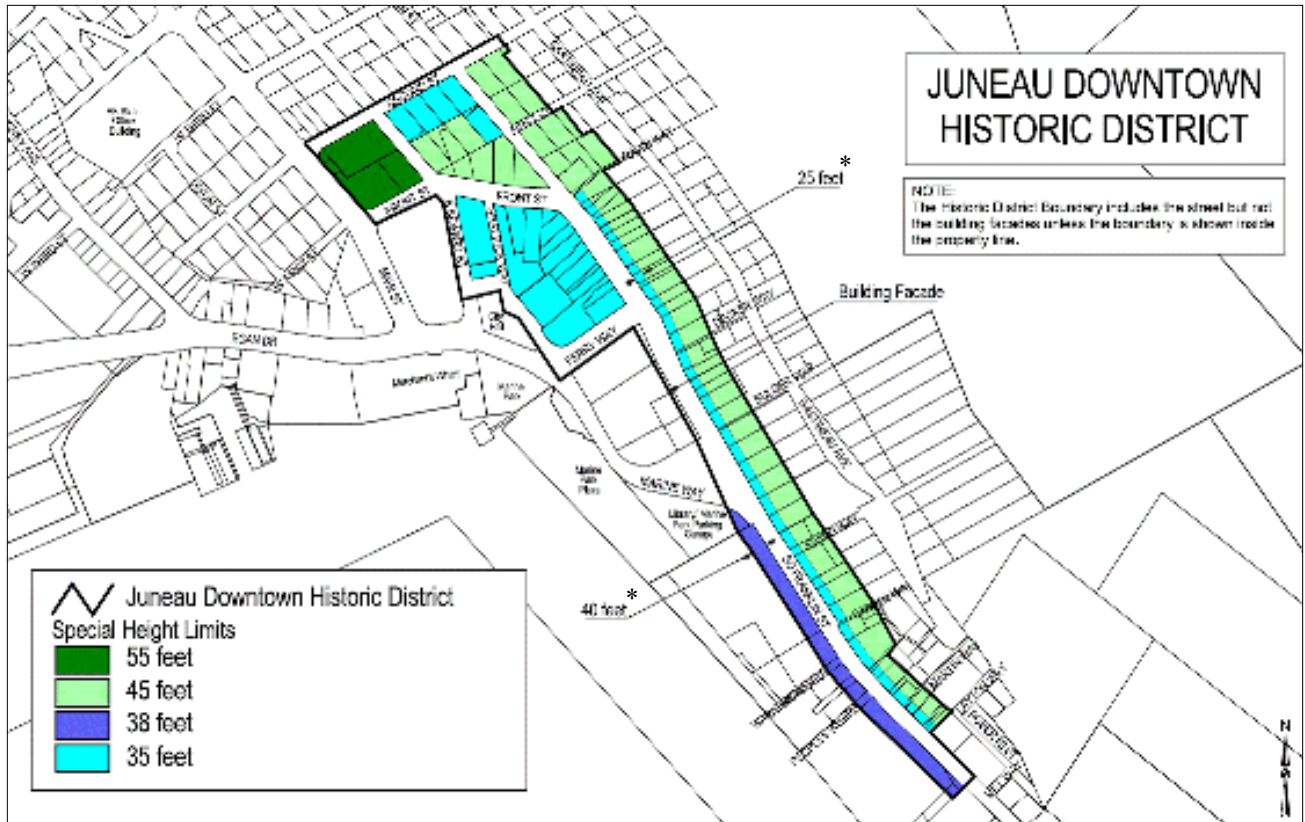

## Downtown Historic District Juneau, AK

The boundary of the Downtown Historic District includes a concentration of “contributing” structures near the intersection of Front and Franklin Streets, and then extends south along Franklin Street itself for several more blocks.

\*Depth of area subject to the designated height limit.

---

## Planning a Preservation Project

When planning a preservation project, it is important to assemble sufficient information about the property to determine its significance and the degree to which it retains its integrity as a historic resource. Then, a specific approach to the overall treatment of the property should be established. This may include keeping the building in its current character, while making appropriate repairs, or also incorporating new, compatible changes. It is then important to determine how surviving historic features will be treated. This may include preserving those features that remain intact, repairing those that are deteriorated and replacing others. These steps in planning a preservation project are presented in this section.

First you must determine your building type:

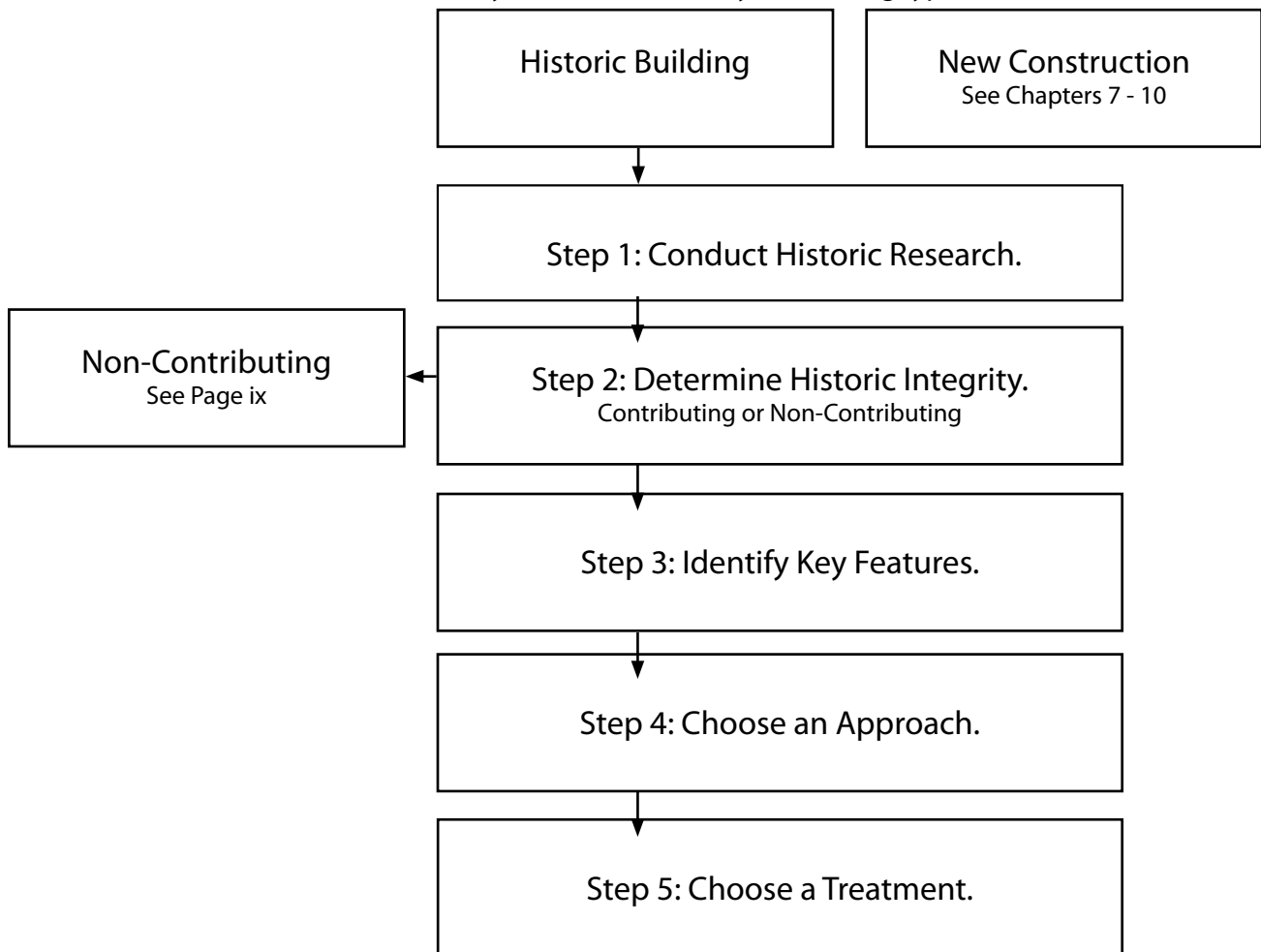





- Includes the work of an architect, engineer or master builder whose individual work has influenced the development of the community;
- Embodies elements of architectural or engineering design, detail, materials or craftsmanship which represent a significant architectural innovation or which is unique.

The guidelines for rehabilitation shall apply to all contributing properties.

#### Non-Contributing Property

There are other buildings that exist within the boundaries of the historic district that do not contribute to its significance. Some of these are ones that have an early construction date, but have been so substantially altered that they no longer convey the historic character and these later alterations have no significance in themselves. Other properties are ones that are more recent, and therefore have not taken on historic significance. Many of these are still “compatible” with the character of the district, but are not “contributors” in terms of the history of the area. Therefore, there are two types of “non-contributing” properties: (1) Older structures that have lost their integrity, and (2) new buildings that are not within the period of significance for the district.

When reviewing improvements to non-contributing properties, preservation approaches are not required. What is important is that any alterations be compatible with the character of the district, just as any new, infill construction should be. Therefore, the guidelines for New Construction shall apply to all Non-Contributing Properties.



This building was constructed later than the historic period of significance. It is considered a “non-contributing” property.

## Differing Degrees of Integrity

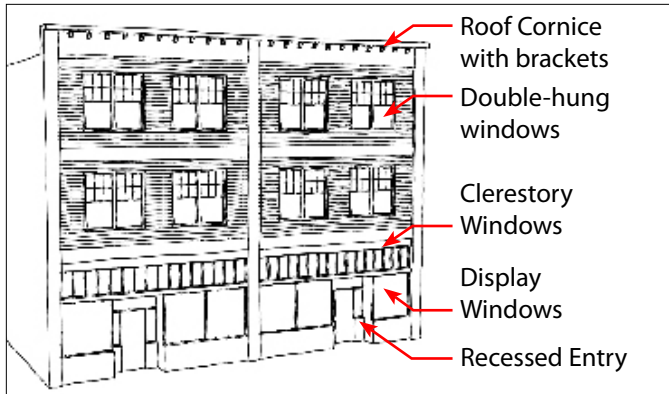

Original Intact: High Degree of Integrity

This property retains a high degree of integrity: most of the original features and materials survive. It would be rated "contributing."

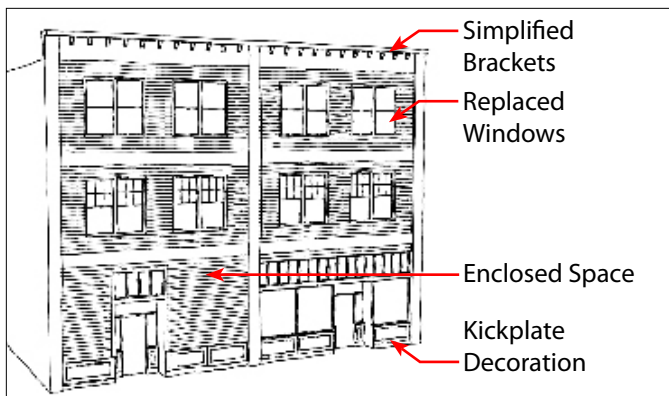

Moderate Alterations: Retains Sufficient Integrity

In this case, the building has lost some of its original features and materials and integrity has been compromised. Nonetheless, these losses are retrievable and therefore the building retains its historic integrity.

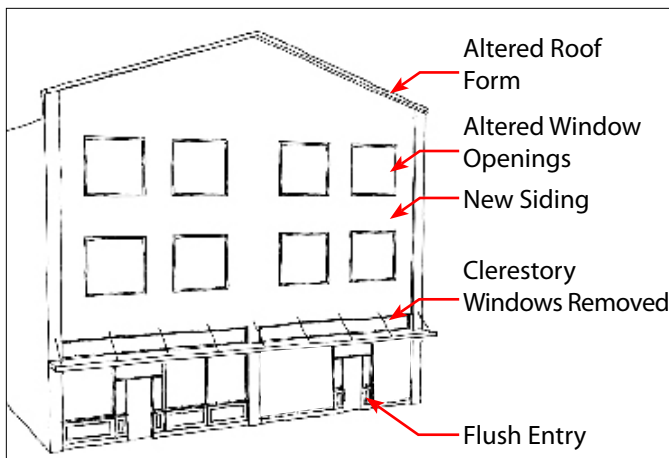

Integrity Lost: Non-Contributing

This building has lost nearly all of the structure's historic fabric. It is no longer possible to adequately interpret its historic character and therefore, has lost its historic integrity.

---

### Step 3: Identify Key Features.

If the property is determined to be a contributor to the district, then it is important to identify which features are significant. This will help determine to what degree the property should be preserved as it is, or where there may be opportunities for compatible alterations to occur. Key features may include the basic shape of the building and its primary construction materials, as well as architectural details, the pattern of windows and doors and other building components that are distinctive. Many of these features are associated with specific building styles, and are summarized in Chapter 2 of this document.

### Step 4: Choose an Approach for Improvement.

Preservation projects may include a range of activities, such as maintenance of existing historic elements, repairs of deteriorated materials, the replacement of missing features and construction of new additions. The following is a list of approaches that are appropriate for contributing properties:

- Preservation. "Preservation" is the act or process of applying measures to sustain the existing form, integrity and material of a building. Some work focuses on keeping a property in good working condition by repairing features as soon as deterioration becomes apparent, using procedures that retain the original character and finish of the features. Property owners are strongly encouraged to maintain properties in good condition.
- Rehabilitation. "Rehabilitation" is the process of returning a property to a state that makes a contemporary use possible while still preserving those portions or features of the property which are significant to its historical, architectural and cultural values. Rehabilitation may include a change in use of the building or additions.
- Restoration. "Restoration" reproduces the appearance of a building exactly as it looked at a particular moment in time. This process may include the removal of later work or the replacement of missing historic features.
- Reconstruction. "Reconstruction" of a building means rebuilding a structure, or a portion of one, that no longer exists exactly as it appeared historically.

While these terms are used interchangeably in informal conversation, the more precise meanings are useful in describing the overall strategy for a contributing property.

For many improvement projects in downtown Juneau, a rehabilitation approach will be the overall strategy. Within that, however, there may be a combination of these approach options as they relate to specific building components. For example, a surviving cornice may be preserved, a storefront base that has been altered may be restored, and a missing kickplate may be reconstructed. This analysis of individual components is described in the next step.

---

## Step 5: Choosing a Treatment for Building Components.

Selecting an appropriate treatment for specific building components of contributing properties will provide for proper preservation of significant features. The treatment options are presented in order of preference. In making a selection, follow this sequence:

1. Preserve: If a feature is intact and in good condition, maintain it as such.
2. Repair: If the feature is deteriorated or damaged, repair it to its original condition.
3. Replace: If it is not feasible to repair the feature, then replace it with one that is the same or similar in character (e.g., materials, detail, finish) to the original one. Replace only that portion which is beyond repair.
4. Reconstruct: If the feature is missing entirely, reconstruct it from appropriate evidence.
5. New feature or addition: If a new feature or addition is necessary, design it in such a way as to minimize the impact on original features. It is also important to distinguish new features from original historic elements.



This contemporary addition to a historic building is appropriate. The addition is set back for the street facade, minimizing the impact on the existing structure. The materials on the addition are also distinguishable from the historic fabric and clearly read as a product of its time.

---

## Alterations

Many historic structures have experienced alterations as tastes changed or the need for additional space occurred. Early alterations typically were subordinate in scale and character to the main building and were often executed using materials similar to those used historically.

Some early alterations may have historic value of their own. An alteration constructed in a manner compatible with the original building and associated with the period of significance may merit preservation in its own right.

In contrast, recent alterations usually have no historic value. Some later additions detract from the character of the building and may obscure significant features. Removing such additions or alterations may be considered.

Alterations are anticipated to continue. It is important that new alterations be designed in a manner compatible with the historic character of the building and implemented without damaging the historic fabric.

---

## Criteria For Replacing Historic Features

If a historic structure has been altered, what is the appropriate approach for its treatment?

When an historically significant building has an important, character defining feature that is deteriorated, altered or missing, it is clear that the feature should be repaired or, if repair is impossible, it should be replaced with materials that are similar to that which existed historically, to maintain the integrity of the building. Sometimes, under certain circumstances, replacing the missing feature or alteration with contemporary but compatible new features might be appropriate. This approach would use a modern interpretation of the building element found traditionally on this building type. Historic details would not be copied literally yet the design should not impede one's ability to interpret the historic character of the structure.

Thus there are two treatments which could be appropriate for repairing or replacing missing or altered features:

- Option A: Reconstruct the historic design. This is the preferred treatment.
- Option B: Replace the missing or altered feature with a contemporary but compatible new feature.

If original is missing...



Two options may be considered:



The original details may be reconstructed, if good evidence is available. This is the preferred treatment.



A simplified version of the original may be considered. Be sure to use the major lines of the original detail.



---

The review authority must determine which option (A or B) is appropriate when evaluating proposals for the replacement of deteriorated, non-historic alterations or missing historic features on historic buildings in Juneau. There are three main criteria that will be considered when handling these types of situations:

- First, what is the significance of the building? If the building has a high level of significance, then reconstruction is preferred. If the building is contributing to the historic sense of the street but is not landmark quality, then more flexibility may be allowed. Either replacing the feature using Option A and B can be considered.
- Second, to what degree has the building retained its historic integrity and how important is the missing or altered feature to conveying the historic character of the building? If the building has retained a high degree of its historic integrity and the missing feature is important to the building's character, then it should be reconstructed. If the building has been substantially altered, then both Options A and B described above can be considered.
- Third, what is the quality of information about the historic features of the building? This criterion addresses the practical issue of whether or not the historic features literally can be replaced or replicated. There may not be sufficient information available about the historic feature to be confident that it can be replaced accurately. Generally, there are three types of information that might be available about the historic feature: pictures or architectural plans of the actual features, existing remnants of the historic features (including marks on the building showing the outline of the feature), or examples of comparable features on existing buildings that were built at the same time and of the same general design. If pictures, plans or remnants exist, then Option A should be followed. If they don't, Option B may be considered.

## Review Process

Contact the City and Bureau of Juneau Community Development Department or reference the CBJ Land Use code for the most current review process.



## How the Guidelines Apply

This chart illustrates how individual chapters of the guidelines apply to specific property types and construction projects. See the appendix for an explanation of the terms used in the “type of work” column. To determine if a property is designated as “contributing,” contact the City and Borough of Juneau’s Community Development Department.

✓ : This chapter applies to the project.

Type of work:	Chapters to use:	Introduction	Chapter 1: Basic Principles of Historic Preservation	Chapter 2: History and Design Character of the Historic District	Chapter 3: Rehabilitation of Historic Properties	Chapter 4: Historic Building Materials	Chapter 5: Historic Building Elements	Chapter 6: Historic Alterations and Additions	Chapter 7: New Construction	Chapter 8: Site Design and Public Streetscape	Chapter 9: Parking Facilities	Chapter 10: Signs
Work on a “contributing property” in the Downtown Historic District.		✓	✓	✓	✓	✓	✓	✓		✓	✓	✓
Work on a “non-contributing” property in the Downtown Historic District.		✓	✓	✓					✓	✓	✓	✓
Work on a “new construction project” in the Downtown Historic District.		✓	✓	✓					✓	✓	✓	✓
Work on a “landmark property” not within the Historic District Boundaries		✓	✓	✓	✓	✓	✓	✓				✓

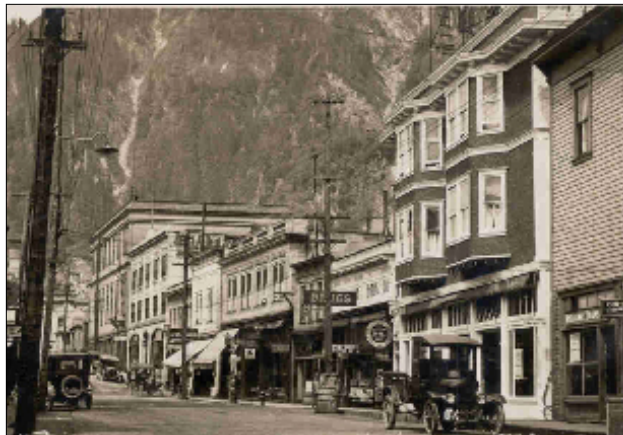

Franklin Street in the early 1900s (left), and in 2008 (right).

## Structure of the Design Guidelines

Each design guideline presented includes several components that constitute the criteria upon which design review decisions will be made.

### Design Element Topic

The guidelines are grouped into pertinent design element categories (e.g., site planning, building materials, storefronts).

### Policy Statement

Each design element category has a policy statement that explains the City and Borough of Juneau's basic approach to the treatment of that topic. In cases where the detailed Design Guidelines do not appear to address a situation, the general policy statement shall serve as the basis for determining appropriateness.

### Design Guidelines

Specific Design Guidelines are numbered in order to reference them during the design review process. The guidelines are not numbered in order of importance.

### Additional Information

Supplementary information is listed as bullet (•) statements, and may include additional requirements, or an expanded explanation of the guideline.

### Illustrations

Design Guidelines may be accompanied by a photograph and/or illustration that supports the guideline language. Illustrations are not included for all guidelines.

Design Element Topic	→	<b>Windows and Doors</b>	
Policy Statement	→	Original windows and doors are important features that help convey the character of a building. Original elements shall be preserved, when feasible.	
Design Guideline	→	3.11 Maintain historic storefront openings.	
Bullets Provide Additional Information	→	<ul style="list-style-type: none"><li>• The size and shape of the storefront are important characteristics that contribute to the integrity of a historic commercial building. Avoid altering the shapes of these features.</li><li>• If these elements have already been altered, consider restoring them if their original condition can be determined.</li></ul>	
Illustration	→		

Sample guideline format.

---

# Chapter 1

## Basic Principles of Historic Preservation

This chapter addresses the role of preservation in Juneau including a discussion of general principles and benefits of preservation. This then forms the base for preservation policies in the community.

The Design Guidelines incorporate principles from The Secretary of the Interior's Standards for the Treatment of Historic Properties, which are administered by the National Park Service. Juneau's guidelines have been adapted from these standards to specifically meet and reflect Juneau's unique district and environment.

A comparison of this historic photograph, with the more recent one at the right, provides information that would help in determining a preservation approach. The early photograph reveals a kickplate below the left display window, and a stepped stem wall at the entry, to the right. A sloped, metal canopy shelters the doorway. In the contemporary photograph, these features are missing, or perhaps obscured with other materials. Investigation of the condition of the wall could help in making decisions about restoration of the original design, or in developing a compatible, new design. (See the preceding discussion on "Criteria for Replacing Historic Features.")



The design guidelines set forth standards to aid in the preservation of historic properties in Downtown Juneau.



## Benefits of Preserving Historic Buildings

### Construction Quality

Many of the buildings in Downtown Juneau were constructed with care. These buildings were thoughtfully detailed with high quality finishes—features that owners today appreciate. The high quality of construction in historic structures is therefore a “value” for both the building owner and the community.

### Livability and Quality of Life

A physical sense of identity can reinforce desirable community social patterns and contribute to a sense of security. When groups of commercial buildings complement each other in their historic context, they create a street scene that is “pedestrian friendly,” which encourages walking and neighborly interaction. Decorative architectural features and distinct architectural styles also contribute to a sense of identity, an attribute that is rare and difficult to achieve in newer areas of the city.

### Economic Incentives

These programs include the National Trust Loans Fund (NTLF), National Trust Community Investment Corporation, and the National Preservation Endowment. The NTLF consists of the Inner-City Ventures Fund (ICVF) and the National Preservation Loan Fund (NPLF). The NPLF provides funding to a spectrum of projects including the rehabilitation of historic buildings and sites. The National Community Investment Corporation makes equity investments in real estate projects that qualify for federal historic tax credits and when available state historic tax credits and New Market Tax Credits. The National Preservation Endowment provides funds to nonprofit organizations and public agencies. The funds offered can be utilized for preservation planning and educational efforts as well as intervention funds for emergency preservation projects. Please contact the NTHP for specific information regarding these and other preservation funding opportunities.

There is also a Federal Rehabilitation Tax Credit; the program is managed by the National Parks Service and Internal Revenue Service in partnership with State Historic Preservation Offices. The federal government makes available a 20% income tax credit for certified rehabilitation projects that are National Historic Landmarks listed on the National Register, and that contribute to the National Register Historic District and certain local historic districts. These are only available to income-producing properties. Contact the City and Bureau of Juneau Historic preservation planner to discuss possible funding options. In some cases, owners also may donate a facade easement and take a charitable gift donation.

The City and Borough of Juneau offers a reduction in property tax levied for qualifying repairs and rehabilitation. The exemption is equal to the value of qualifying work, within certain limits. The work must first be approved by the Community Development Department.



---

## Economic Benefits to the Community

Historic structures are irreplaceable. They bestow an identity and provide a tangible history of a place. These qualities make them highly desirable to both members of the community and property owners. Maintaining the historic character of the district encourages heritage tourism which is an important part of the local economy. (Rehabilitation projects also contribute more to the local economy than do new building programs because each dollar spent on a preservation project has a higher percentage devoted to local labor). By contrast, new construction typically has a higher percentage of each dollar spent devoted to materials that are produced outside of the local economy. Therefore, when money is spent on rehabilitating a building, it has a higher “multiplier effect,” keeping more money in the local economy. Studies show that each dollar spent on a rehabilitation project continues to circulate in the local economy five to seven times, which helps support other businesses.

## Responsibility of Ownership

Ownership of a historic property carries a responsibility to respect the historic character of the property and its setting. Ultimately, residents and property owners should recognize that historic preservation is a long-range community objective that promotes economic well-being and overall viability of the community at large.



The first step in planning a preservation project is to identify and maintain significant features and materials.



Heritage tourism is an important part of the local economy, and therefore preserving historic structures is important because it enhances the appeal of the city to visitors.



New construction in the historic district should maintain characteristics of the district while being distinguishable as new construction.



An important principle for new construction is to maintain the uniform setback and alignment of buildings in a block.

## Basic Principles for Non-Contributing Buildings and New Construction

There are structures in the historic district that are non-contributing and other sites where new infill construction will occur. For these situations, the focus of design should be on being compatible with the historic context, and not on the principles for treatment of a historic property that are outlined earlier in this section. More flexibility is afforded to these sites, in terms of the details of design, when they respect the overall relationships of building mass, form, materials and scale and setting. Respecting the tradition of having transparent storefronts at the sidewalk edge is an example. While a storefront should be provided when renovating an existing, non-contributing building or constructing new, it need not have a historic appearance.

The historic district remains a vital place that is mostly built, but there are still opportunities for new development within its boundaries. Designing a building to fit within the historic district requires careful thought. It is important to realize that while a historic district conveys a certain sense of time and place associated with its history, it is also dynamic. While the Design Guidelines for New Construction provide direction for specific design issues, some basic site design and new construction principles form the foundation for compatible new construction. The following principles apply:

1. Respect the design character of the nearby historic properties.
  - Don't try to make a new building look older than it is. The copying or exact replication of architectural styles or specific historic buildings is discouraged. Often, a contemporary interpretation of those architectural styles seen historically will work best.
2. Maintain the setbacks and alignments of buildings in the surrounding context.
  - A new building shall align with nearby historic buildings. Other alignments, such as those seen from similar cornice heights, storefront heights and the relative alignment of windows and moldings are also important.
3. Relate to the scale of nearby historic buildings.
  - A new building shall relate at the street level to the general size, shape and proportions of historic buildings. This does not mean that the absolute height must be the same, but that the scale of nearby historic buildings be reflected in the infill design. It is equally important for a new building to use similar primary building materials, or materials similar in appearance.

---

When a new building is built, it should be in a manner that reinforces the basic visual characteristics of the area. This does not mean that new buildings must look old. In fact, imitating historic styles is generally discouraged; historians prefer to be able to “read” the evolution of the street, discerning the apparent age of each building by its style and method of construction. When a new building is designed to imitate a historic style, this ability to interpret the history of the street is confused.

Rather than imitating older buildings, a new design shall relate to the traditional design characteristics of the area while also reflecting the architecture of its time. New construction may do so by drawing upon some basic building features—such as the way in which a building is located on its site, the manner in which it relates to the street, and its basic mass, form and materials—rather than applying detailing which may or may not have been historically appropriate. Therefore, it is possible to be compatible with the historic context while also producing a design that is distinguishable as being newer.

---

## Period of Significance

In most cases, a property is significant because it represents or is associated with a particular period in its history. Frequently, this begins with the construction of the building and continues through the peak of its early occupation. Building fabric and features that date from the period of significance typically contribute to the character of the structure.

The Downtown Juneau Historic District has a period of significance which spans 55 years (1889 - 1944). Throughout this period of significance, the district has been witness to a number of buildings and additions which have become an integral part of the area. Conversely, several structures have been built or alterations have been made after this period which are generally considered non-historic and may be considered for removal or replacement. In general keep this in mind:

Early alterations, additions or new construction (more than 50 years old) may have become historically significant and thus merit preservation.

- Many additions or alterations to buildings and districts that have taken place in the course of time are themselves evidence of the history of the building and its neighborhood and therefore may merit preservation.

More recent alterations, additions or new construction that are not historically significant may be removed.

- Forexample, asphalt, aluminum, vinyl or others synthetic siding may presently obscure the original siding. In this case, removal of this alteration and restoration of the original material is appropriate and strongly encouraged.
- Most alterations less than fifty years old lack historic significance.

Some recent additions detract from the character of a historic building and may obscure significant features. In this case, the first floor character has been altered. Because the upper portion retains a high degree of integrity with distinctive detailing, restoration of the original first floor should be considered.





# Chapter 2

## History and Character of the Downtown Historic District

### Introduction

(Adapted from the previous City and Borough of Juneau Design Standards Handbook, 1984)

With the discovery of gold in 1880 in Gold Creek, the Town of Juneau was born, and continuous gold findings throughout the 1890s assured its growth. Permanent commercial establishments replaced quickly constructed buildings during the initial boom, and created what is now the Downtown Historic District.

The Downtown Historic District has an elongated “L” shape. The spine of the “L” includes buildings on both sides of South Franklin Street and is bounded by the old ferry terminal on the south and by Second Street on the north. Building heights in the district vary from 25 to 50 feet with most buildings less than 35 feet high. Many buildings have sidewalk canopies that visually unite the street. The upper stories typically have double hung windows arranged singly or in pairs.

Juneau’s Downtown Historic District developed over several significant historical periods, which is why it has different types of architectural styles that reflect the times in which major phases of development took place. The town’s first buildings were erected along Main and Seward Streets in 1880. By 1885 the demand for waterfront space encouraged expansion south. The oldest building still standing in the historic district today is Madsen’s Rooming House, built in 1889. Pilings, driven into tidal flats, created lower Front Street (later South Franklin Street). Further expansion



Downtown Juneau contains an excellent representation of early twentieth century commercial architecture.

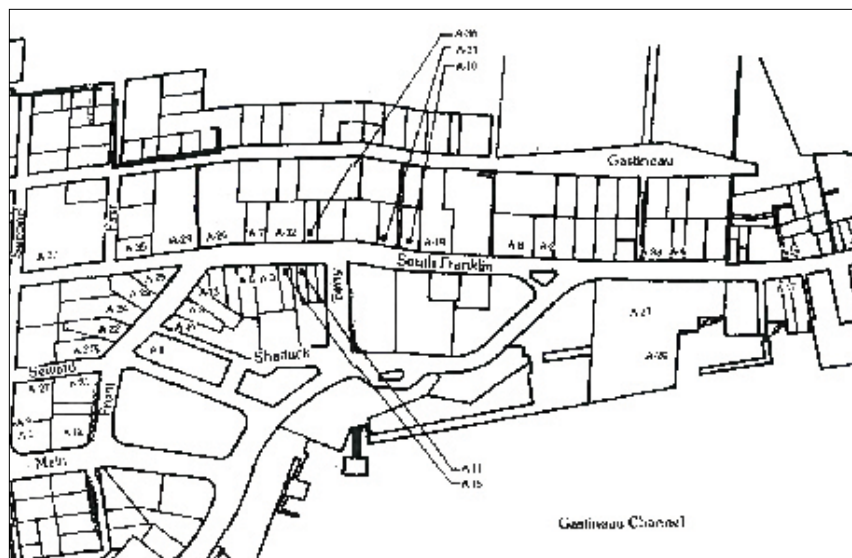

Location of historic resources in the Downtown Historic District. Please see the appendix for an enlarged version of this map.

---

on Franklin occurred after the Alaska-Juneau Gold Mining Company built a mill south of the townsite in 1913. With the waterfront filled, new buildings had to be built north on Franklin Street.

Today the Juneau Downtown Historic District includes many historical contributing buildings. Nineteen were constructed prior to 1911, fourteen between 1912 and 1920, and nine between 1921 and 1944. Within the district boundaries are non-contributing buildings, which include recently built buildings or ones that were altered so that their historic integrity was destroyed. The non-contributing buildings are dispersed throughout the district. For many of these, their scale, lines, massing, color, and detailing are compatible with the contributing buildings.



In 1914, most buildings in Juneau were clustered around Front and Franklin Streets.

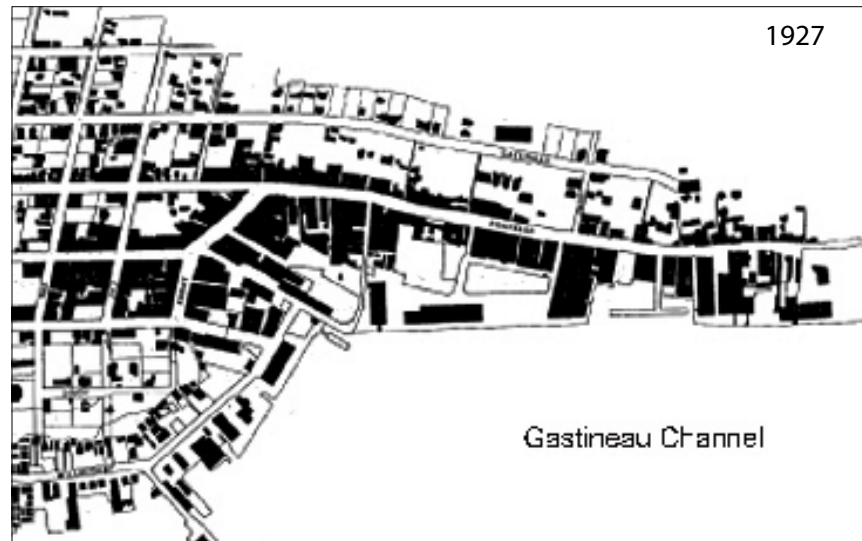

By 1927, a noticeable amount of additional development had taken place on the southern end of Franklin Street. These early development patterns should be considered when determining the context for new development in the historic district and around its edges.

---

## Key Features of the Downtown Historic District

Juneau's Downtown Historic District can be considered as having two sub-areas with distinct features, the core of the district and South Franklin Street. The Core area is located on the north edge of the district, from Second Street at the north to around Marine Way in the south. The Core contains the greatest concentration of historic buildings and has the strongest sense of place. The South Franklin area of the historic district is the remaining southern portion along South Franklin Street. This area has similar character as the Core area, but has a slightly lower scale with building heights lower along the street. The South Franklin area also has more non-contributing structures and underdeveloped lots than the Core, which is an opportunities for more infill new development.

### Development Pattern

The streets that make up the Downtown Historic District do not fit into a traditional grid pattern, and the majority of the lots are non-rectilinear. Historically, buildings were oriented to the curving street causing some parcels and buildings to have unique forms that add to the distinctive character of Downtown Juneau. The lots on the south end of Franklin have a short depth caused by the extreme slope of topography that the lots abut.

### Building Heights

Building heights in the district vary from 25 to 50 feet, with the majority being less than 35 feet. The taller buildings are generally located to the northern section of downtown, farthest from the waterfront. The effect of the height of taller buildings is offset by the pedestrian scale at the street level, and by the number and variety of adjacent building heights.

### Building Setbacks

Buildings within the Downtown Historic District are built to the sidewalk. Most buildings are also constructed to the side lot lines, leaving minimal space between structures, if at all. This creates a solid wall along the sidewalk edge.



Development patterns create uniquely shaped lots along Front Street.



### Storefront Windows and Canopies

Most buildings, particularly the predominant commercial structures, have storefront windows at street level. The majority of buildings in the downtown have canopies spanning the entire street front of the building, protecting pedestrians from the weather.

### Sense of Street Enclosure

The downtown has a strong sense of definition and enclosure along many of its streets. The location of buildings at the sidewalk edge, minimal spacing between buildings, and the overhead canopies covering most sidewalks create a strong sense of definition along the street edge.

### Pedestrian Orientation and Scale

First floor heights combined with canopies and storefront windows create a pedestrian-scaled streetfront. Key building elements, including windows, doors and facade details, have a human scale that supports pedestrian activity. Storefront windows provide views to activities inside, creating interest for passersby and those within the buildings.



The addition of a canopy is visible in these photographs from 1913 and 2006. The canopy was added during the historic period.



Many buildings in Downtown Juneau share similar characteristics.



## Building Types and Styles

Many of Juneau's downtown buildings are excellent representations of early twentieth century commercial architecture as it evolved in small Pacific coast communities. Late Victorian, Early 20th Century Commercial, Art Deco and Art Moderne architectural styles are found here. Some other historic buildings do not fall into any specific architectural style, but they tend to have similar characteristics which help to define the downtown's unique historic character. These characteristics include wooden storefront windows on the first floor, double hung windows on the upper stories, flat roofs and canopies over the streetfronts.

The key features of the styles found in Juneau should be preserved.

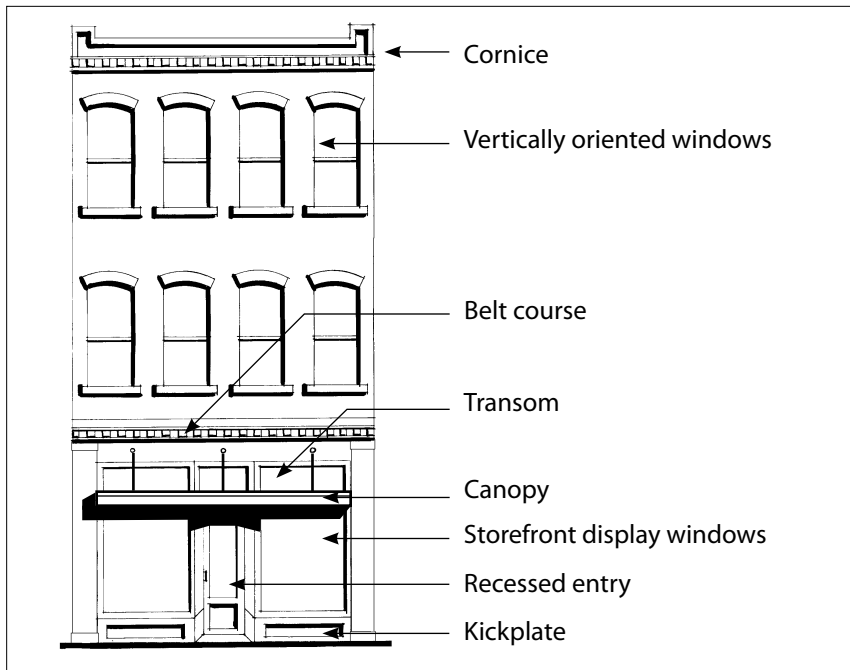

Traditional commercial storefronts in Downtown Juneau include many of these features. These are consistent features among many styles in downtown.

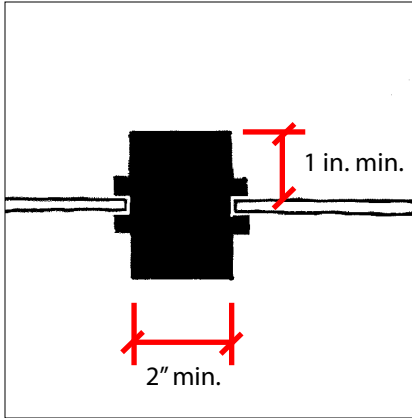

Appropriate minimum dimensions for typical storefront window framing.

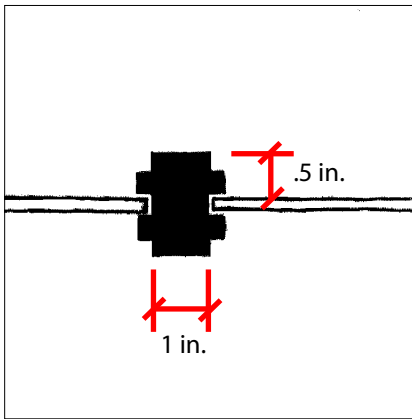

Inappropriately sized storefront window framing.

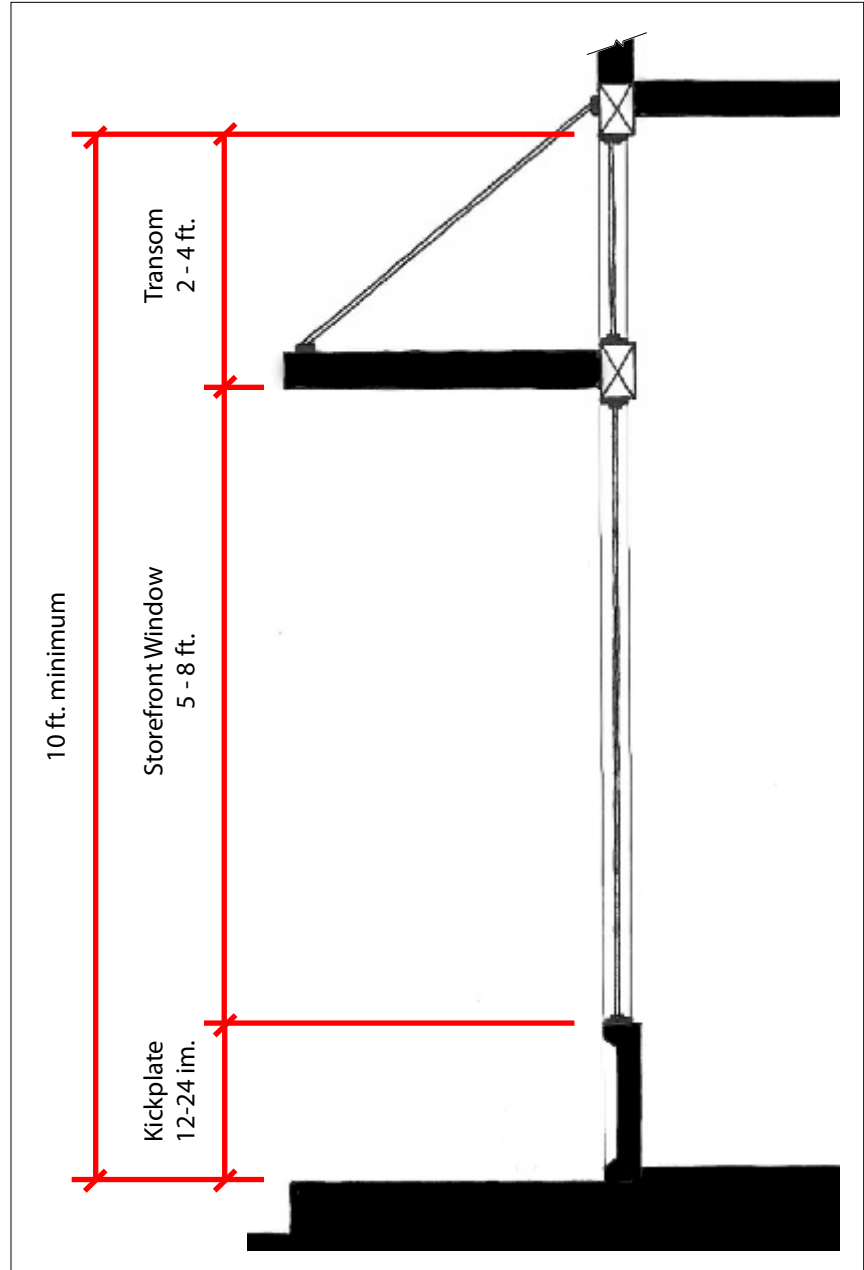

The diagram above shows minimal dimensions for a typical storefront. Traditional framing on a storefront provides significant depth on a facade to create shadow lines and details which convey pedestrian scale and interest.

---

## Late Victorian

• 1883-1911

Many buildings constructed in Juneau between 1883 and 1911 were built in a Late Victorian Style. They generally have large display windows and small recessed entrances with continuous sidewalk canopies and clerestory windows. The buildings erected before 1900 have utilitarian, commercial facades with simplified details, including plain cornices and parapets, and the repeated use of standard size, double hung wood windows. The buildings erected between 1900 and 1911 are larger in scale, often two to three stories. These have more elaborate detailing, including towers, ornate cornices, scrolled beams and fluted pilasters.

### Characteristics

- Two to three stories - Victorian construction commonly used a base, middle and cap building technique.
- Wood frame construction - The typical post and beam construction was used along with wooden cladding.
- Elaborate detailing - The use of intricate metalwork and woodwork was fairly common.
- Decorative cornices - Generally including overhanging eaves with supporting bracket work and a decorative facade cap.
- Towers or turrets - Typically found at corners of buildings, towers and turrets would either be rounded or multi-faceted shapes.
- Large display windows - Generally found in the base section, the display windows would often span between supporting structures.
- Recessed entrances - Found at street level, entrances are usually set back from the building edge with flanking transom windows.
- Clerestory windows - Clerestory windows are usually found above the first floor canopy and below the decorative floor cornice of the second story.



The Seward Building (1913, 145 S. Franklin Street) has a decorative cornice, recessed entry and facade detailing characteristic of a Late Victorian Style.



Projecting parapet caps with elaborate supporting bracket work can be seen in this cornice detail. Below the brackets, a strand of decorative metalwork laces the building.



The Koosher Building (1893, 130 Second Street) and the Germania Dance Hall and Saloon (1895, 162 S. Franklin Street) are some of Juneau's first examples of the Late Victorian Style. The Alaska Steam Laundry (1901, 174 S. Franklin Street) and Valentine Building (1904) (both listed on the National Register of Historic Places) are examples of later buildings done in the Late Victorian Style. Characteristic elements such as decorative cornices, fluted pilasters, and turrets with conical roofs, dentils and swags define this style.

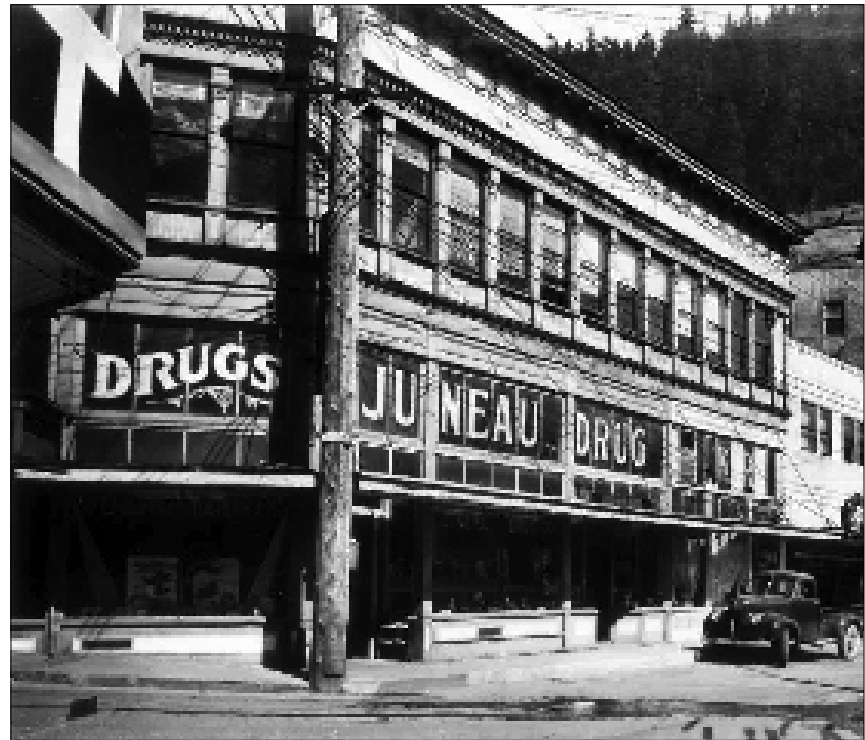

The Valentine Building (1905, 119 Seward Street) (above) is a Late Victorian style building. The same corner (left) is seen from a different angle in 2007.



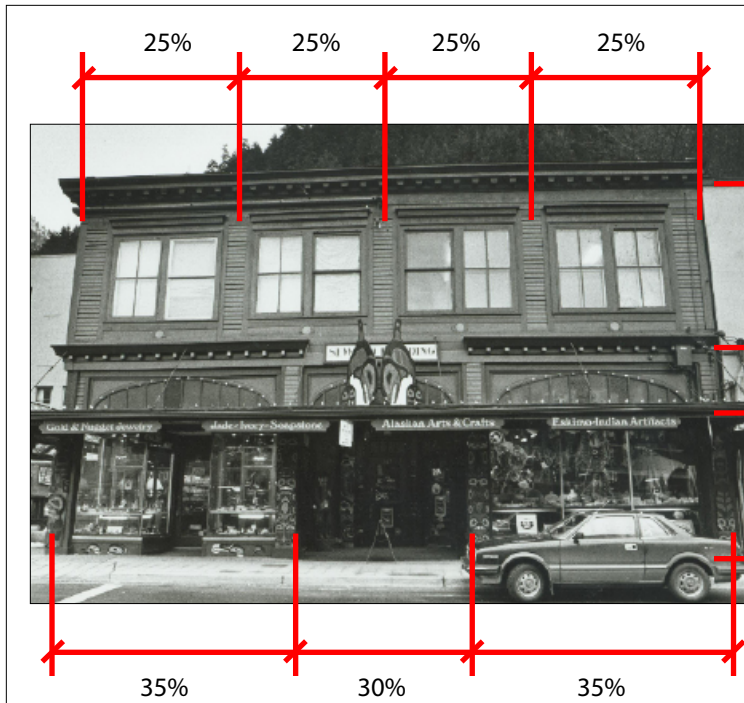

In this example of a Late Victorian commercial facade the integrity of the original storefront remains intact. The proportions across the entire facade present good examples of typical proportions for this style. The upper floor and lower floor are both subdivided into different numbers of bays. Across the upper floors there are four bays which are consistent in size and repetitive in composition. Across the storefront the composition remains symmetrical, with storefront bays framing one center recessed entry which is inset and slightly less wide as the outer bays. The vertical proportions of this building are also typical of this style, with the storefront and transom windows, representing the base, the upper floor as the middle and the decorative cornice as the cap.



Each of the storefront bays in this example of a Late Victorian commercial facade present proportions which are typical to the style. In this example the horizontal proportions of each storefront bay reflect the proportions of the overall storefront facade with two outer bays framing a recessed entry. The kickplate in this building makes up the lower 10% of the facade's vertical proportions, typical kickplate proportions for this style range from 10-15%. The storefront windows represent 60% of this facade, where between 50-70% is typical. Transom windows characteristic of this style make up roughly 30% of the facade height of this storefront, where 20-30% is typical for the style.



Characteristics of the Early 20th Century Commercial Style, such as a corner recessed entry, concrete construction and rectangular fenestration patterns, can be found in the Goldstein Building (1914, 130 Seward Street).

## Early Twentieth Century Commercial

• 1912-1920

The Early Twentieth Century Commercial Style reflects advances in technology and increased economic development. A healthy local economy encouraged construction of larger, more impressive buildings. Although most Juneau buildings were wood, those erected in this style were reinforced concrete.

### Characteristics

- Flat facades
- Rectangular fenestration patterns - Windows are usually grouped in sets of two or three with a pilaster strip between groups.
- Flat sidewalk canopies - Canopies occur near the top of the first floor.
- Reinforced concrete construction
- Flat roof - Generally the roof section of the building has a parapet and cornice detailing.
- Recessed entryway - Found at street level, entrances are usually set back from the building edge with flanking transom windows.
- Storefront windows - Generally large storefront windows would span between structural members.

This example of an Early Twentieth Century style commercial storefront is located on a sloped site and the storefront steps up with the topography. Although the storefront has been slightly remodeled the original proportions typical of this style are still apparent across a large portion of the street level facade. Typical proportions of transom windows for this style range from 15-30%, however in this example the height of the transom is gradually reduced as the canopy steps up with the topography. The molding at the top of the transom eventually meets with and becomes the canopy. At this point the storefront no longer has a transom element, however the proportions of the remaining storefront elements maintain proportions typical to this style which are established by other complete storefront bays on the building.





The J & E Building/Hotel Cain (1913) and the five-story Goldstein Building (1914), both reinforced concrete structures, date from this period and are examples of the Early 20th Century Commercial Style. Many elements of this style are also reflected by contributing buildings in the district which are not specifically identified as a particular style.



The Hotel Cain (1913, 127 S. Franklin Street) was constructed with reinforced concrete and is an example of the Early 20th Century Commercial Style.



The J. J. Stocker Building (241 Front Street) retains some of its character-defining features, especially from the transom up. This building qualifies as a contributing structure.

If the building is structurally sound and sealed from the elements, the next step in a preservation master plan for this building would be to reconstruct the original storefront.

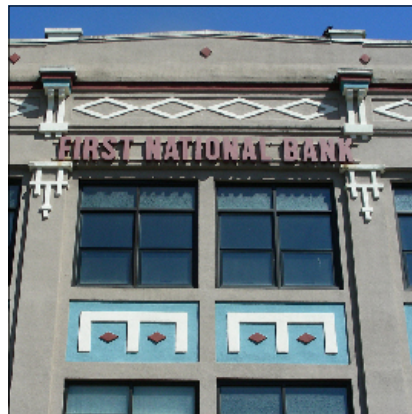
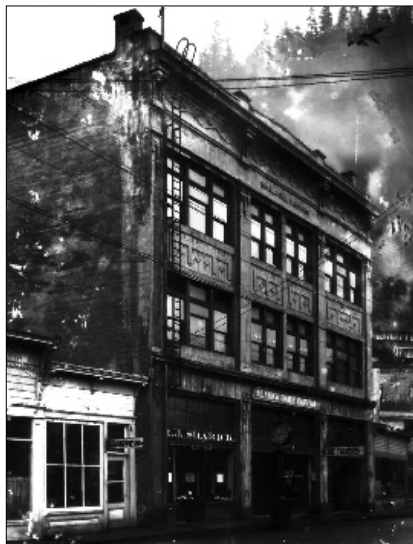

The Hellenthall Building (1916, 220 Front Street) (Above and Left) and the Stocker Building (Upper Right) display characteristics of the Early 20th Century Commercial Style.



Windows are often grouped in sets of two or three with a pilaster separating them. Note the substantial depth of the detail opening in this building.



The Baranof Hotel (1932, 105 Franklin Street) has “porthole” windows, rounded corners, and horizontal bands, all characteristic of the Art Moderne style.

## Art Moderne

• 1930-1940

Art Moderne style incorporated machine aesthetic into architecture in the sense that buildings could emulate motion and efficiency. It is also referred to as Streamlined Moderne, and always carried the aura of the futuristic. Whatever the term, in this case architecture followed industrial design, and “the slick look” was used for everything from irons to baby carriages. It relies upon repetition of surface decorations on a relatively sleek form.

### Characteristics

- A combination of rounded corners and angular shapes
- Glass block
- Metal sash windows - Sometimes constructed with sets of small panes, windows are often placed at corners.
- Horizontal bands - Often referred to as “speed bands,” horizontal banding is repeated to mark floor sections of a building
- References to ocean liners - References to machines are seen in the use of “porthole” windows and metal railings.

This example of an Art Moderne commercial storefront does not express all the typical elements of storefronts since it has been remodeled many times, most recently in the 1980s. Other examples of this style may have the typical storefront elements this example is lacking. This building has no transom windows above the canopy, however ‘speed bands’, horizontal banding details, occupy the area where these windows would typically be seen in other storefront styles. The relatively flat facade, typical for this style, is broken up to portray a human scale. The majority of the storefront is made up of roughly 65% window space, with a small header space above these windows making up approximately 10% of the facade height. This storefront also has an implied kickplate with very little detailing, which is taller than typically seen in other styles, making up approximately 25% of the facade height.



---

The nine buildings built between 1921 and 1939 include Art Moderne and Art Deco architectural styles. Constructed of reinforced concrete, the Baranof Hotel (1939) with its smooth wall surfaces, flat roof, curved corners and horizontal lines on the exterior walls is a local example of the Art Moderne Style.



The use of metal grates is a reference to the concept of the building as a machine seen in the Art Moderne Style.





## Art Deco

- 1930-1950

This style is related to Art Moderne in its decoration of surfaces, but in the case of Art Deco, lines are angular rather than curvilinear. Art Deco is most easily identified by its architectural ornament, which includes stylized floral motifs and repetitive geometric forms incorporating sharp angles and segments of circles. Zigzags, chevrons and diamond patterns are typical and often are applied as decorative moldings or are integral to masonry patterns themselves. Rounded or angular corner windows were often used. Building entrances were embellished with decoration extending to hardware and light fixtures that reflected the style. Glass brick panels were often lit from behind with colored lights.



Buildings built in the Downtown between 1921 and 1939 include Art Deco details.



## Characteristics

- Variety in color and texture - Texture and color is used to give the building a human scale and accentuate vertical and horizontal lines.
- Stucco and tile combined - Colored brick or tile was used as a decorative element to accent the stucco siding.
- Projecting sunshades-Canopies and awnings were common additions to street level fronts.
- Rounded corner windows
- Zigzag or chevron moldings - Zigzag, chevron and diamond patterns were often used to decorate the cornice.
- Molded metal panels or grills
- Stylized floral patterns
- Repetitive geometric forms
- Carrara glass

Several of the buildings built between 1921 and 1939 were executed in the Art Deco style. With its smooth surfaces, stylized motifs decorating the facade and vertical projections about the roof line, the Alaska Electric Light and Power Building (1936, 134 Franklin Street) is a good example.



The Alaska Electric Light and Power Building.



A decorative panel serves as a cap to a vertical attached column, or pilaster, a typical Art Deco detail.



Geometric shapes enrich cornices and other facade components in the Art Deco style.



This example of an Art Deco storefront has proportions which are typical to the style. The kickplates make up roughly 15% of the storefront's height, where 10-15% is typical for this style. 55% of the overall storefront height is the storefront windows, typically a range of 50-70% is seen. The transom windows make up the top 30% of this building's storefront, typical transom range from 15-30%. With two larger bays surrounding a recessed entry the horizontal proportions of this building are also representative of this style. The width of horizontal bays vary more than vertical proportions as they are more dependent on the overall building width. Typical proportions for recessed entries range from 20-30% and for each storefront bay vary between 30 and 40% of the overall bay width.

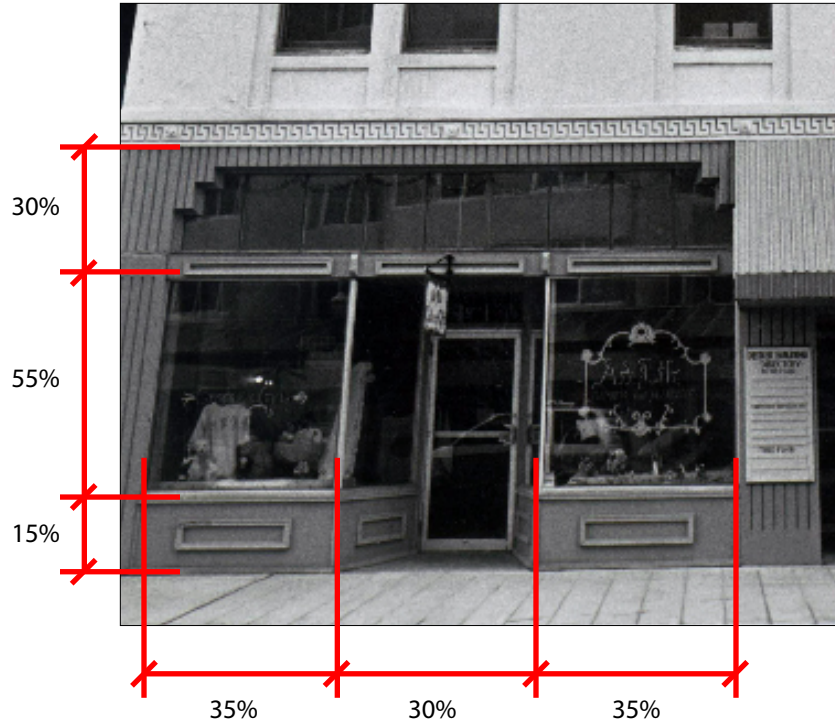



---

# Chapter 3

## Design Guidelines for Rehabilitation of Historic Properties

This chapter presents design guidelines for the treatment of historic properties in Juneau’s Downtown Historic District. The guidelines are based on a “three level” approach: the first level is to preserve existing historic features, the next level is to repair deteriorating features, then, if features are beyond repair, the final level is to replace those features in kind.

This three-step sequence of treatments reflects the principles outlined in Chapter 1, in which the least intervention for a historic component is preferred. These basic guidelines for rehabilitation apply to the property as a whole, as well as to individual building components. Further guidance about building elements is provided in subsequent chapters.

Note that compliance with all of the guidelines is expected, but there may be circumstances in which a balancing of the specific guidelines and their intent statements will occur in order to achieve the most appropriate preservation solution.

### Preserve

Historic materials, architectural details and window and door openings contribute to the character of a structure and are referred to as character-defining features. They are often closely associated with specific architectural styles. These features shall be preserved when feasible; their continued maintenance is the best preservation method.

- 3.1 Preserve significant stylistic and architectural features.
- Canopies, storefront windows, cornices and decorative concrete castings are examples of architectural features that should not be removed or altered.
  - The best preservation procedure is to maintain historic features from the outset so that intervention is not required. Employ preventive measures such as rust removal, caulking, limited paint removal and reapplication of paint. These should not harm the historic materials.
  - Maintain key character-defining features.
  - Do not remove or alter architectural details that are in good condition or that can be repaired.

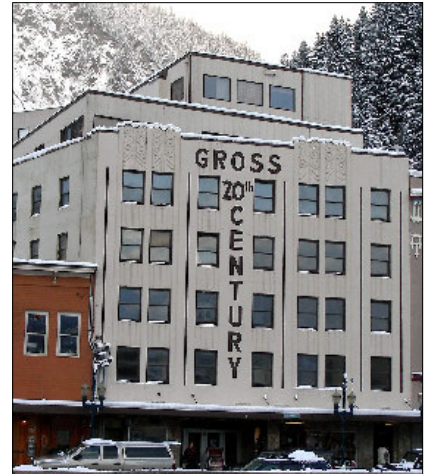

Preservation shall be the first step in maintenance of historic buildings.



Protect wood siding and other wood surfaces with a painted finish.

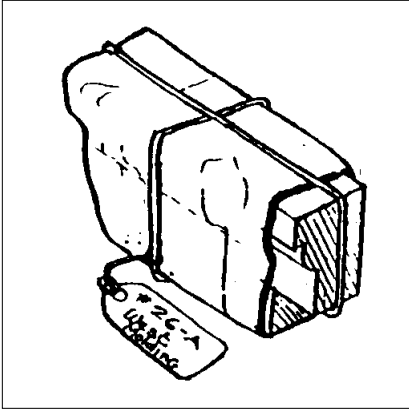

When disassembly of a historic feature is required in a restoration procedure, document its location so that it may be repositioned accurately.

- 3.2 Avoid adding elements or details that were not part of the original building.
  - For example, details such as decorative millwork from a Late Victorian style should not be added to an Art Deco building.
- 3.3 Protect architectural details from moisture accumulation that may cause damage.
  - Regularly check details that have surfaces which can hold moisture for long periods of time. This is especially important along cornices and parapets.
- 3.4 Maintain original siding materials.
  - Using any material, either synthetic or conventional, to cover historic material is inappropriate. Doing so would obscure the original character and change the dimensions of walls, which are particularly noticeable around door and window openings. The extra layer also could hide or cause further decay.
  - If a property already has a non-historic building material covering the original, it is inappropriate to add another layer of new material, which would further obscure the original. Removing the covering is recommended.
- 3.5 Preserve original materials that show signs of wear rather than replace them when feasible.
  - All materials weather over time and a scarred finish does not represent an inferior material, but simply reflects the history and age of the building, and should be accepted as a part of the character of a historic resource.

## Repair

In some cases, original architectural details may be deteriorated. Horizontal surfaces and windowsills are likely to show the most deterioration because they are more exposed to weather. When deterioration occurs, repair the material and any other related problems. Replacing a feature is inappropriate, when it can be repaired instead.

- 3.6 Repair deteriorated primary building materials by patching, piecing-in, consolidating or otherwise reinforcing the material.
  - Repair only those features that are deteriorated, and avoid the removal of damaged materials that can be repaired.
  - Isolated areas of damage may be stabilized or fixed, using consolidants. Epoxies and resins may be considered for wood repair and special masonry repair components also may be used.
  - Patch, piece-in, splice, consolidate or otherwise upgrade existing materials using recognized preservation methods.
  - Protect features adjacent to the area being worked on.
  - Employ treatments such as rust removal, caulking, limited paint removal and reapplication of paint or stain.

- 3.7 Plan repainting carefully.
- Always prepare a good substrate. Remove damaged or deteriorated paint only to the next intact layer, using the gentlest means possible, prior to painting.
  - Use compatible paints. Some latex paints will not bond well to earlier oil-based paints without a primer coat.
- 3.8 When disassembly of a historic element is necessary for its restoration, use methods that minimize damage to the original materials.
- When disassembly of a historic feature is required during restoration document its location so it may be repositioned accurately. Always devise methods of replacing disassembled details in their original configuration.
- 3.9 Use technical procedures for cleaning, refinishing and repairing architectural details that will maintain the original finish.
- When choosing preservation treatments, use the gentlest means possible that will achieve the desired results.
  - Perform a test patch to determine that the cleaning method will cause no damage to the material surface. Many procedures can actually have an unanticipated negative effect upon building materials and result in accelerated deterioration or loss of character.
  - Harsh cleaning methods, such as sandblasting, can damage the historic materials, changing their appearance. Such procedures are inappropriate and should be avoided.
  - If cleaning is appropriate, a low pressure water wash is preferred. Chemical cleaning may be considered if a test patch is first reviewed and negative effects are not found.

## Replace

While restoration of an original feature is the preferred alternative, in-kind replacement is an option when repair is not feasible. When the original material must be replaced, using the same material as the original is preferred, but an alternative material may be considered when it conveys characteristics similar to the original.

- 3.10 Replacement of an original feature should occur only if the material is beyond repair.
- Repairing the original is preferred, because it will maintain the integrity of the property.
- 3.11 Replace only the amount needed.
- For example, if a few boards of lap siding are beyond repair, then only they should be replaced, not the entire wall.



Early 20th century.



2006.



In-kind replacement, as seen on the roof shingles above in 2007, is an option.

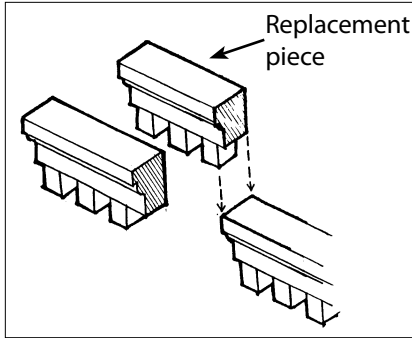

Where replacement of an element is required, remove only those portions that are deteriorated beyond repair.

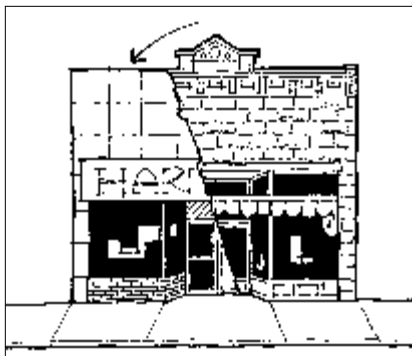

Consider removing later covering materials that have not achieved historic significance.

3.12 Replacement of missing or deteriorated architectural elements should be accurate.

- The design should be substantiated by physical or pictorial evidence to avoid creating a misrepresentation of the building's history.
- Use the same kind of material as the original when feasible. A substitute material may be appropriate if the size, scale, shape, texture, color and finish (composition) conveys the visual appearance of the original. For example, if the original material is wood clapboard, then the replacement material should be wood as well, matching the original in size, the amount of exposed lap and in finish.
- Primary building materials, such as wood siding and concrete, shall not be replaced with synthetic materials.

3.13 When reconstruction of an element is impossible, develop a new design that is a simplified interpretation of it.

- This is appropriate when inadequate information exists to allow for an accurate reconstruction.
- The new element shall be similar to comparable features in general size, shape, texture, material and finish.

3.14 Remove later covering materials that have not achieved historic significance.

- If original materials are presently covered, consider exposing them. For example, asphalt siding that covers original wood siding should be removed.
- Once the non-historic siding is removed, repair the original, underlying material.
- In some cases removing a second finish may cause damage to the original and may not be desirable. Test the finish to assure that the original material underneath will not be permanently damaged.

## Protect and Maintain Property

All historic properties in the Downtown Historic District should be maintained to prevent the need for more extensive repairs or replacement of building features in the future. Prolonged deferred maintenance results in "demolition by neglect."

3.15 Minimize the deterioration of a property.

- Provide regular maintenance to a historic building and its site features in order to minimize the need to replace historic materials.
- Maintain material through appropriate treatments such as caulking, limited paint removal and re-application of paint.
- Maintain photographic documentation of the property for use in future preservation efforts.

# Chapter 4

## Design Guidelines for Historic Building Materials

Building materials strongly reflect the character and age of a building. The preservation and maintenance of original building materials on a historic property is important. The following preservation guidelines apply to specific materials on historic properties.

See NPS Preservation Brief 16: The Use of Suitable Materials on Historic Building Exteriors, for further information.

### Wood Siding

Wood is a material used historically for exterior siding, trim and ornamental details. When properly maintained, wood will survive for centuries. To preserve wood, maintain its painted finish. Most wooden structures in Juneau's Downtown are painted. Lap siding is most prevalent on wooden buildings, but other wood sidings have been used. These construction methods should be preserved in a manner that conveys their historic character. The following guidelines apply to wooden features on historic buildings.

#### 4.1 Preserve original wood siding.

- Avoid removing siding that is in good condition or that can be repaired in place.
- Remove only siding which is deteriorated and beyond repair.
- If portions of wood siding must be replaced, be sure to match the style and lap dimensions of the original.



The Madsen's Rooming House (1899, 369 S. Franklin Street) is a contributing structure. The storefront material is a later alteration that detracts. A more appropriate material should match the historic profile and be painted.

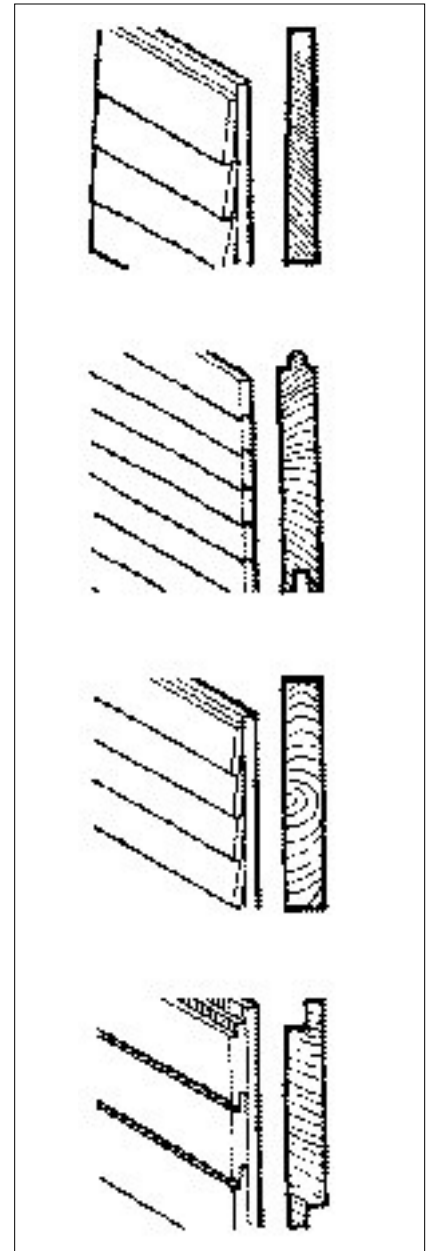

Appropriate types of wood lap siding.









Metal accent features in Downtown Juneau.

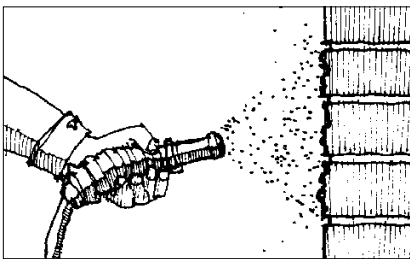

Use approved technical procedures for cleaning, refinishing and repairing historic materials. Harsh cleaning methods, such as sandblasting, can damage the historic materials and change their appearance.

• • • • •  
• See NPS Preservation Brief 6: Dangers of  
• Abrasive Cleaning to Historic Buildings for  
• further information.  
• • • • •

## Metals

Metals were used for a variety of applications including columns, roofing, canopies and decorative features. Historically developments closer to the waterfront used more metal. Metal applications shall be maintained where they exist. The following guidelines apply to metal features on historic properties.

- 4.15 Preserve architectural metal features that contribute to the overall historic character of the building.
  - Provide proper drainage on metal surfaces to minimize water retention.
  - Maintain protective coatings, such as paint, on exposed metals.
- 4.16 Repair metal features by patching, splicing or otherwise reinforcing the original metal whenever possible.
  - New metal shall be compatible with the original.
- 4.17 Use the gentlest cleaning method possible when removing deteriorated paint or rust from metal surfaces.
  - Harsh, abrasive cleaning methods shall be avoided.

## Cleaning Materials and Methods

Some cleaning materials can do more harm than good. Many cleaners can be harsh and abrasive, often damaging historic buildings materials. When maintaining historic buildings, cleaning materials and methods which do not harm the original building materials shall be used. The following guidelines apply to cleaning materials and methods used on historic buildings.

- 4.18 Use the gentlest cleaning method possible to achieve the desired result.
  - Abrasive methods such as sandblasting are inappropriate.
  - Most traditional cleaning methods can be harmful. A firm experienced in the cleaning of historic buildings should be hired to advise on the best, lowest impact method of cleaning.
- 4.19 Use caution when repairing or removing original building materials.
  - Many historic finish materials may contain harmful substances such as asbestos and lead. Use appropriate methods to handle these materials.
- 4.20 Consult The Secretary of the Interior's Standards for the Rehabilitation of Historic Building and Standards for the Treatment of Historic Properties for illustrated guidelines and further information on appropriate cleaning methods.



---

# Chapter 5

## Design Guidelines for Historic Building Elements

Individual building elements, including windows, doors, and cornices, can strongly affect the character of a building and the preservation and maintenance of the original elements is important. The following preservation guidelines apply to specific elements on historic properties.

### Windows

The character-defining features of a historic window and its distinct materials and placement shall be preserved. In addition, a new window shall be in character with the historic building. This is especially important on primary facades and at street level. More flexibility is appropriate on non-streetfront walls and rear walls.

- 5.1 Preserve the functional and decorative features of a historic window.
  - Features important to the character of a window include its frame, sash, muntins, mullions, glazing, sills, heads, jambs, moldings, operation and groupings of windows. Repair frames and sashes rather than replacing them, whenever conditions permit.
- 5.2 Preserve the position, number and arrangement of historic windows in a building wall.
  - Enclosing a historic window opening in a key character-defining facade is inappropriate, as is adding a new window opening. This is especially important on primary facades where the historic ratio of solid-to-void is a character-defining feature.
  - Greater flexibility in installing new windows may be considered on rear walls.
- 5.3 Preserve the size and proportion of a historic window opening.
  - Reducing an original opening to accommodate a smaller window or increasing it to receive a larger window is inappropriate.
- 5.4 Preserve the historic ratio of window openings to solid wall on a primary facade.
  - Significantly increasing the amount of glass on a character-defining facade will negatively affect the integrity of the structure.
  - Some flexibility in window ratio is appropriate for upper levels.

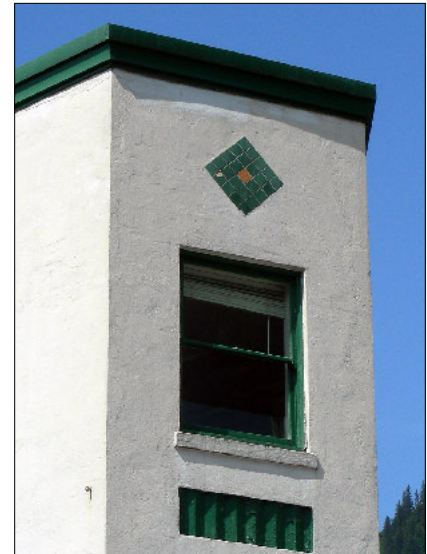

Protect and maintain the stylistic features and proportions of a historic window opening.

•••••  
• See NPS Preservation Brief 9: The  
• Repair of Historic Wooden Win-  
• dows, for further information.  
•••••



The appearance of window components should match those of the original in dimension, profile and finish.

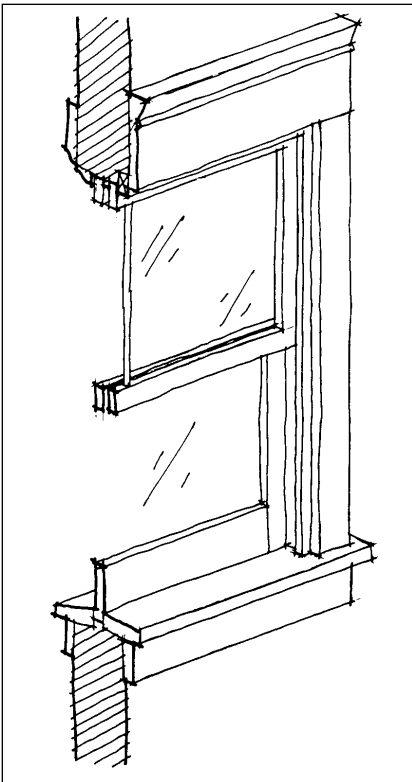

Match, as closely as possible, the profile of the sash and its components to that of the original window.

- 5.5 Match a replacement window to the original in its design.
- If the original is double-hung, then the replacement window shall also be double-hung, or at a minimum, appear to be so. Match the replacement also in the number and position of glass panes.
  - Matching the original design is particularly important on key character-defining facades.
- 5.6 In a replacement window, use materials that appear similar to the original.
- Using the same material as the original is preferred, especially on key character-defining facades. However, a substitute material may be considered on secondary facades if the appearance of the window components will match those of the original in dimension, profile and finish.
  - Vinyl or aluminum clad windows may be considered on upper floors only if the original type of material is unavailable. The replacement must match the original's dimensions, detail and composition.
- 5.7 Match, as closely as possible, the profile of the sash and its components to that of the original window.
- A historic wood window may have a complex profile. Within the window's casing, the sash steps back to the plane of the glazing (glass) in several increments. These increments, which individually only measure in eighths or quarters of inches, are important details. They distinguish the actual window from the surrounding plane of the wall.
- 5.8 Use a storm window to enhance energy conservation rather than replace a historic window.
- Install a storm window on the interior, when feasible. This will allow the character of the original window to be seen from the public way.
  - If a storm window is to be installed on the exterior, match the sash design of the original windows. A metal storm window may be appropriate if the frame matches the proportions and profiles of the original window. It shall fit tightly within the window opening without the need for sub-frames or panning around the perimeter. Match the color of the storm window sash with the color of the window frame; do not use an anodized or a milled (a silvery metallic) finish. Finally, set the sash of the storm window back from the plane of the wall surface as far as possible.
  - Energy conservation can also be addressed by regular maintenance of historic windows to be sure heat loss is minimized.

---

## Doors

The character-defining features of a historic door and its distinct materials and placement shall be preserved. In addition, a new door should be in character with the historic building. This is especially important on primary facades.

- 5.9 Preserve the decorative and functional features of a primary entrance.
- Maintain features important to the character of a historic doorway. These may include the door, frame, screen door, threshold, glass panes, paneling, hardware, detailing, transoms and flanking sidelights.
  - Avoid changing the position and function of original front doors and primary entrances.
- 5.10 Maintain the original proportions of a significant door.
- Altering its size and shape is inappropriate.
- 5.11 When a historic door is damaged, repair it and maintain its general historic appearance.
- If it is beyond repair, replacement may be considered.
- 5.12 When replacing a door, use materials that appear similar to that of the original.
- If the original was wood, then that is preferred for a replacement.
  - A metal door, may be used as a replacement if it is similar in character and finish.
- 5.13 When replacing a door, use a design that has an appearance similar to the original door, or a door associated with the style of the building.
- Installing a very ornate door is discouraged, unless photographic evidence can support its use.
- 5.14 If energy conservation and heat loss are a concern, consider using a storm door instead of replacing a historic entry door.
- Generally, wood storm doors are most appropriate.
  - A metal storm door may be appropriate if it is simple in design and if the frame is painted so that raw metal is not visible.
  - Energy conservation can also be addressed by regular maintenance of historic doors to be sure heat loss is not occurring.



Examples of appropriate doors

••••• See NPS Preservation Brief 11:  
 ••••• Rehabilitating Historic Storefronts,  
 ••••• for further information.  
 •••••

## Commercial Storefronts

Many storefronts in Juneau have components seen traditionally on commercial buildings. The repetition of these standard elements creates a visual unity at the street that shall be preserved.



Character-defining elements of storefronts, including transoms, should be preserved and restored.

5.15 A commercial storefront shall not be altered, obscured, or removed during a rehabilitation project, as storefronts help maintain street level interest for pedestrians by providing views to goods and activities inside first floor windows. The following commercial storefront character-defining elements shall be preserved:

- Display windows: The main portion of glass on the storefront, where goods and services are displayed.
- Transom: The upper portion of the display window, separated by a frame.
- Kickplate: Found beneath the display window. Sometimes called bulk-head panel.
- Entry: Usually set back from the sidewalk in a protected recess.
- Upper-story windows: Windows located above the street level. These usually have a vertical orientation.
- Cornice molding: A decorative band at the top of the building.

5.16 If a storefront has been altered, restoring it to the original design is preferred.

- If evidence of the original design is missing, use a simplified interpretation of similar storefronts.
- Historic photographs of Juneau and its downtown buildings are available and shall be used when determining the original character of a storefront design.
- If the alteration has acquired historic significance in its own right it shall be maintained rather than altered further or restored to an earlier period of significance.

5.17 Alternative designs that are interpretations of traditional storefronts may be considered where the historic facade is missing and no evidence of it exists.

- Where the original is missing and no evidence of its character exists, a new design that uses the traditional elements may be considered.
- However, the new design shall continue to convey the character of typical storefronts, including the transparent character of the display window.
- Greater flexibility in treatment of rear facades is appropriate. However, care shall be taken to preserve storefronts on those buildings which have traditional commercial storefronts on more than one facade, such as a corner building.
- The kickplate, located below the display window, adds interesting detail to the streetscape and shall be preserved.
- If the original kickplate is covered with another material, consider exposing the original design.



5.18 If the original kickplate is missing, develop a sympathetic replacement design.

- Wood is an appropriate material for replacements on most styles. However, ceramic tile and masonry may also be considered when appropriately used with the building style.

5.19 Retain the original shape of the transom glass in historic storefronts.

- Transoms, the upper glass band of traditional storefronts, introduce light into the depths of the building. These bands shall not be removed or enclosed.
- The shape of the transom is important to the proportion of the storefront, and it should be preserved in its historic configuration.
- If the original glass is missing, installing new glass is preferred. However, if the transom must be blocked out, be certain to retain the original proportions.



Preserve the historic character of a storefront when it is intact.



The transoms on the building above have been covered. Although they reflect the openings that were once located there, a more appropriate treatment would be to reopen transoms. Compare with photos on page 15 and 17.

- See NPS Preservation Brief 4:
- Roofing for Historic Buildings, for
- further information.

## Roofs

While many roofs downtown are flat and hidden, some are sloped, gable forms. Where the roof itself is a significant feature, these guidelines apply.

- 5.20 Preserve the character of a historic roof, including its form and materials, whenever feasible.
  - Avoid altering the angle of a historic roof; maintain the perceived line and orientation of the roof as seen from the street.
  - Retain and repair roof detailing.
  - Avoid removing historic roofing material that is in good condition.
  - Do not cover historic roof materials.
- 5.21 New or replacement roof materials should convey a scale and texture similar to those used traditionally.
  - When replacement is necessary, use materials that are similar to the original in both style as well as physical qualities and use a color that is similar to that seen historically.
  - When choosing a roof replacement material the architectural style of the structure should be considered.



Flat roofs are the most common roof form in Downtown Juneau.



- 5.22 Preserve the original eave depth of a historic structure.
- The shadows created by traditional overhangs contribute to one’s perception of the building’s historic scale and provide weather protection; therefore, these overhangs should be preserved. Cutting back roof rafters and soffits or in other ways altering the traditional roof overhang is inappropriate.
- 5.23 Avoid using conjectural materials or features on a roof.
- Adding features such as a widow’s walk (an ornate railing around the roof ridge) on buildings where there is no evidence that one existed creates a false impression of the building’s original appearance, and is inappropriate.

## Cornices

Most historic commercial buildings have cornices to cap their facades. Their repetition and general alignment along a street contribute to the visual continuity on a block and shall be preserved.

- 5.24 A parapet wall, especially on a primary elevation or highly visible facade, should be preserved.
- When a parapet wall becomes deteriorated, there is sometimes a temptation to lower or remove it. Avoid doing this because the flashing for the roof is often tied into the parapet, and disturbing it can cause moisture problems.
  - Inspect parapets on a regular basis. They are exposed to the weather more than other parts of the building, so watch for deterioration such as missing mortar or excessive moisture retention.
  - Avoid waterproofing treatments, which can interfere with the parapet’s natural ability to dry out quickly when it gets wet.
- 5.25 Reconstruct a missing cornice when historic evidence is available.
- Use historic photographs to determine design details of the original cornice.
  - Replacement elements should match the original in every detail, especially in overall size and profile. Keep sheet metal ornamentation well painted.
  - The substitution of another old cornice for the original may be considered, provided that the substitute is similar to the original.
- 5.26 A simplified interpretation is also appropriate for a replacement cornice if evidence of the original is missing.
- Appropriate materials include wood, concrete and stamped metal.



The cornice line contributes to the visual continuity of the street.

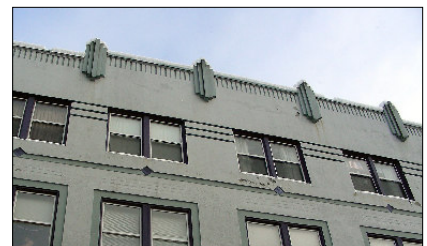

Cornice details in Juneau’s Downtown Historic District.



Canopies provide shelter over sidewalks and prove very valuable in inclement weather.

• • • • •  
 • See NPS Preservation Brief 44:  
 • The Use of Awnings on Historic  
 • Buildings Repair, Replacement  
 • and New Design, for further infor-  
 • mation.  
 • • • • •

• • • • •  
 • See also:  
 • City and Bureau of Juneau Land  
 • Use Code Article VIII. Cano-  
 • pies and Awnings 49.15.800  
 • - 49.15.850 for further informa-  
 • tion.  
 • • • • •



Canopies step with the street level.

## Canopies and Awnings

Canopies are simple in detail, reflecting the character of the buildings to which they are attached. They are primarily flat; many of the early canopies were as wide as the sidewalk area.

Fabric awnings are simple, and fit into the building opening which they are covering. Historically these awnings were often operable (i.e., could be rolled, raised and lowered) to accommodate changing weather patterns. Rigid fabric awnings may be considered on an historic building on a case-by-case basis by the City and Borough of Juneau Community Development Department.

### 5.27 Preserve existing canopies.

- Do not permanently remove canopies on historic structures.

### 5.28 If a canopy has been altered, consider restoring it to the original design.

- Restore the historic canopy if it has been altered.
- If an awning or canopy existed and is now missing, it should be reconstructed.

### 5.29 An alternative design that is an interpretation of a traditional canopy is appropriate.

- Where the original canopy is missing and no evidence of its character exists, a new design that uses the traditional elements may be considered.
- Canopies should convey the character of typical canopies of the building type.
- Canopies should not obscure character-defining features or damage the historic fabric of the building.

### 5.30 Awnings are only appropriate on certain building types and styles.

- Historical evidence of the previous awning on the building must be provided in order to gain approval for locating an awning.
- Awnings should be of rigid frame construction. Operable awnings are inappropriate.
- The scale of awnings should be in proportion to the building, and not dominate the facade
- The materials should be canvas or a synthetic canvas.
- Material must be durable and able to withstand the extreme climate.
- Awnings should have a matte finish. Glossy finishes are inappropriate.
- Awnings cannot be lit internally.

## Balconies

Balconies are not common building elements, however there are a few cases where the use of such elements has occurred.

- 5.31 A balcony may be considered on an existing structure where:
- There is sufficient evidence showing that such an element once existed as an important character defining feature of the structure; or
  - It will not be directly visible from the public right-of-way, such as on the rear of a building.
  - Balconies are inappropriate where they will negatively impact the historic integrity of an existing structure.
- 5.32 A balcony should be compatible with a building's period of significance.
- Materials used for balconies should be appropriate to the period of significance and style of the building.



The rooftop use on the left side of the building includes an appropriately set back patio space. The rooftop use on the right includes a railing which is inappropriate and should be set back from the building facade.

## Rooftop Uses

Rooftop uses such as patios, decks and outdoor dining may be provided as amenity spaces, however their use should not detract from the integrity of the structure or impact the quality or appearance of the streetscape.

- 5.33 Minimize the impact of rooftop uses on the integrity of an existing structure.
- Rooftop activity areas are inappropriate where they will negatively impact the historic character of an existing structure.
- 5.34 Minimize the visual impact of rooftop uses as seen from the street.
- Setback a rooftop activity such that it is not visible from the sidewalk below.
  - Railing, umbrellas, tables, and other patio furniture should be setback.

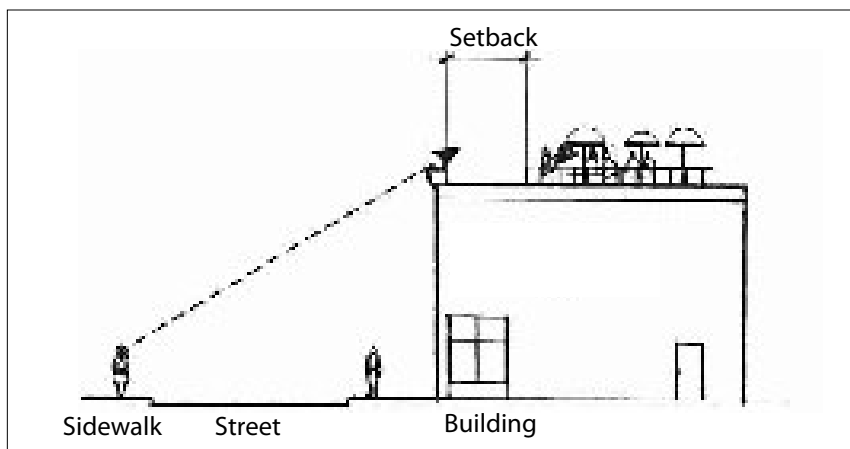

Rooftop use areas should not be visible from the sidewalk below.



It is inappropriate for features such as air conditioning units and other exterior equipment to be visible from the street.

## Mechanical Equipment and Service Utilities

Equipment located on the exterior of a historic building can detract from the integrity of the resource. Equipment should be located where it is not visible, or only minimally so, to avoid negative impacts. The following guidelines apply to mechanical equipment and service utilities on historic buildings.

- 5.35 Minimize the visual impacts of satellite dishes and other rooftop devices.
- Features such as satellite dishes or other rooftop devices should be installed in a manner such that they will not interrupt the original cornice or ridge line.
  - Flat skylights that are flush with the roof plane may be considered on the rear and sides of the roof. Locating a skylight or other device on a front roof plane should be avoided.
- 5.36 Locate and install standpipes and other service equipment such that they will not damage historic facade materials.
- Do not cut channels into historic facade materials as it may damage historic building fabric.
- 5.37 Minimize noise impacts of mechanical equipment and service utilities.
- When feasible locate equipment away from adjacent residential properties and/or buffer it. Additional noise attenuation measures should be taken if the equipment noise exceeds national standards.

---

# Chapter 6

## Design Guidelines for Historic Alterations and Additions

### Historic Additions

Some early additions may have taken on historic significance of their own. One constructed in a manner that was compatible with the original building and that is associated with the period of significance may merit preservation in its own right. In contrast, more recent additions that detract from the character of the building may be considered for removal.

••••• See NPS Preservation Brief 14: New  
••••• Exterior Additions to Historic Buildings:  
••••• Preservation Concerns, for further  
••••• information.  
•••••

- 6.1 Preserve an addition that has achieved historic significance in its own right.
- Such an addition is usually similar in character to the original building in terms of materials, finishes and design.

### Adaptive Re-Use

Converting a building to a new use that is different from that which its design reflects is considered to be “adaptive re-use.” For example, converting a residential building to an office is adaptive re-use. A good adaptive re-use project retains the historic character of the building while accommodating its new function.

- 6.2 Seek uses that are compatible with the historic character of the building.
- Building uses that are closely related to the original use are preferred. An example would be the conversion of a residential-type building to an office. This can be accomplished without radical alterations to either the interior or exterior of the structure.



Alternative approaches to additions.

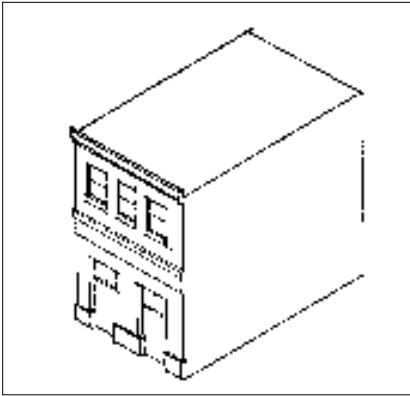

An original two-story building, before an addition. Compare with sketches below.

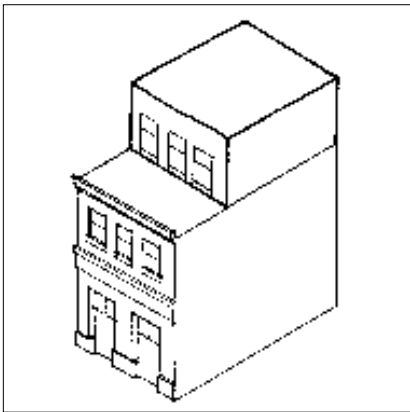

New addition above

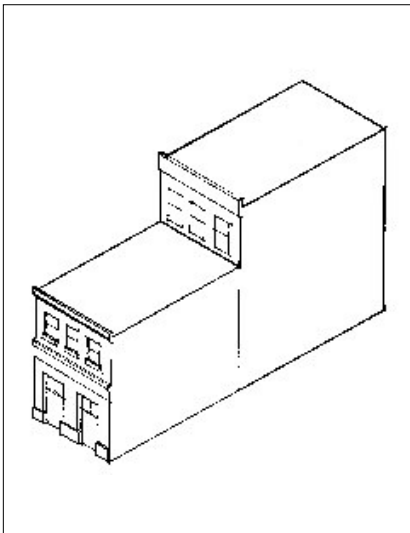

New addition to the rear

## New Additions to Historic Properties

A primary concern for an addition is to keep it in character with the existing building and to not significantly impact historic integrity.

- 6.3 An addition shall be compatible in scale, materials and character with the main building.
- An addition shall relate to the building in mass, scale and form. It shall be designed to remain subordinate to the main structure.
  - An addition to the front of a building is inappropriate.
- 6.4 An addition shall not damage or obscure architecturally important features.
- For example, the loss or alteration of a cornice line shall be avoided.
- 6.5 An addition may be made to the roof of a building if it does the following:
- An addition shall be set back from the primary, character-defining facade, to preserve the perception of the historic scale of the building.
  - Its design shall be modest in character, so it will not attract attention from the historic facade.
  - The addition shall be subtly distinguishable as new.
- 6.6 In limited circumstances, an addition may be made to the roof of a building and not be set back from character-defining facades, if the following criteria are met (For example, an addition shall be distinguished from the existing building. A change in material or a decorative band may accomplish this):
- An addition shall maintain the alignment of storefront elements, moldings, cornices and upper-story windows that exist on the main part of the building.
  - The addition shall be compatible in scale, texture and materials with the original.



An appropriate rear-facing alley addition.



---

# Chapter 7

## Design Guidelines for New Construction

The historic integrity of Juneau's Downtown is nationally recognized and important to maintain. New buildings in the district must both respect the existing historic character of the district, while not creating a false sense of history in new structures that would damage the integrity of the district as a whole. Downtown Juneau is not known for one specific historic period of significance, but rather developed over several periods of significance. As such, Juneau has several different types of architectural styles, reflecting the times in which major phases of development took place. While no one style dominates, the majority of the buildings maintain similar qualities that serve to unify the visual quality of the district. New buildings shall follow the historic patterns of development in Juneau by both reflecting the unifying visual qualities and character-defining features of the district, and by reflecting the time in which they are built. The following guidelines apply to new buildings and to alterations of non-contributing buildings in the historic district.



New construction shall respect the character-defining features of the historic district and reflect the time in which they are built. This new building uses traditional components, including storefronts, canopies and transoms. While they appear similar to historic ones, these are in fact contemporary interpretations, which is appropriate.

---

## Placement and Orientation

With the exception of small gaps in the building wall that occur for pedestrian or vehicular alleyways, most structures in the historic district are built to the full width of the parcel and to the front lot line. The resulting “street wall” pattern shall be maintained in new development.

- 7.1 Maintain the alignment of buildings at the sidewalk edge.
- Locate the front street wall at the sidewalk line when feasible.
  - If the building has a modern interpretation of a storefront, it shall maintain the feel of the street wall through use of architectural elements and features at the street edge.
- 7.2 Street facades shall span lot widths.
- Spaces between buildings shall be kept to a minimum to maintain the street wall and sense of enclosure at the sidewalk.
  - Exceptions are for access ways to side or rear entrances.
- 7.3 Lots that have multiple street fronts shall be built to address each street facade.
- Buildings on corner lots shall be built to the sidewalk on both streets to the extent possible without interfering with public safety.
  - Buildings on lots which face multiple streets shall be double fronted and built to the sidewalk at both street fronts.
  - Storefronts are appropriate along all street level facades of the buildings.
- 7.4 Buildings on angular lots shall be built to lot lines.
- The angular street pattern and the resulting non-rectilinear building forms are characteristics of Downtown Juneau and new buildings may continue this pattern.

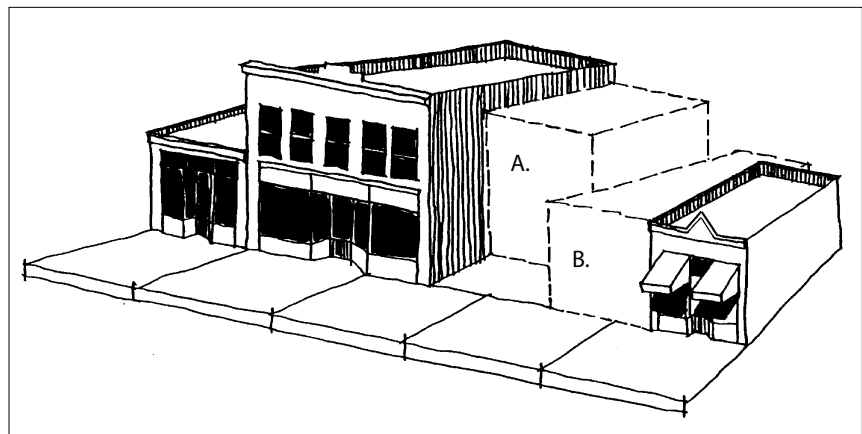

Align the building front at the sidewalk edge. Building A is an inappropriate example of building placement along the sidewalk edge, since it does not align with the other buildings on the block. Building B is an appropriate example.

## Mass, Scale and Height

Patterns of building occur along the street by the repetition of similarly-sized building elements. For example, uniform facade widths, evenly spaced along Front Street, create a rhythm that contributes to the visual continuity of the district. At a smaller size, the repetition of upper-story windows across most building fronts also creates a unifying effect. These features and similar patterns are some of the most important characteristics of the district and shall be respected in all new construction.

- 7.5 Traditional spacing patterns created by the repetition of uniform buildings widths along streets shall be maintained.
- In most cases, a facade shall not exceed established widths without a clear expression of the historic pattern.
  - Where a building must exceed this width, use a change in design features to suggest the traditional building widths. Changes in facade material, window design, facade height or decorative details are examples of techniques that may be considered. These variations shall be expressed through the structure such that the composition appears to be a collection of smaller masses.
- 7.6 A new building shall incorporate a base, middle and a cap.
- Traditionally, buildings were composed of these three basic elements. Interpreting this tradition in new buildings will help reinforce the visual continuity of the area.
  - This also applies to existing, non-contributing structures.
- 7.7 A new building shall maintain the alignment of horizontal elements along the block.
- Align the height of window sills, moldings and midbelt cornices with adjacent and nearby buildings.
  - Where sloped streets occur, a building facade shall step along the street (see image at bottom of page 45).



Example of new construction which would relate to existing historic structures by maintaining the alignment of horizontal features, producing a similar floor to floor height, dividing a larger facade into smaller modules and maintaining the visual scale of buildings. (Aspen, CO)



Design lower building levels to express the alignment of elements seen traditionally in the district.

A new building shall maintain the general alignment of horizontal elements along the block. Window sills, moldings and midbelt cornices are among those elements that may be seen to align. Note the alignment of building elements varies by one to two feet on the sloping portions of Franklin Street. Storefronts and canopies generally align in more level portions of the district.

See page v in the Introduction for the Historic District Boundary and Building Height Designations Map.

- 7.8 Floor-to-floor heights shall appear to be similar to those seen historically.
- First floor heights shall be equal to those of the surrounding buildings. Note that first floor heights are taller than upper floors.
  - Design windows in new construction to appear similar in height, location and scale to those seen historically.
- 7.9 Maintain the visual building scale of two to four stories in height.
- Develop a primary facade that is in scale and alignment with surrounding historic buildings.
  - Design the lower levels to express the alignment of elements seen traditionally in the block; where additional height is allowed, it shall be set back to maintain the visual appearance of scale from the street level.

The storefronts shown are appropriate infill examples that could occur within the district. They are described below.

**Wood Frame Case Study:**

The facade is wood frame construction with a metal storefront structural system. The second story of the facade is wood lap siding with a profile that matches a historic wood lap siding. The kickplate is a series of smooth colored concrete panels to complement the buildings color scheme. The upper story windows are double hung (wood) with wood trim. The doors are solid core wood with glass panels. A horizontal canopy is supported by cables. Shadow lines denote the depth of detail within the facade design.



**Concrete Case Study:**

The first floor is cast concrete with a metal storefront structural system. The upper story is wood frame with an applied stucco finish. The base of the building is a darker colored concrete to complement the building's color scheme. The building trim components, including the window headers, cornice and belt course, are wood. The upper story windows are double hung (wood). The doors are solid core wood with glass panels. A horizontal canopy is supported by cables. Shadow lines denote the depth of detail within the facade design.





---

## Building Materials

Wood frame and concrete were the primary construction methods used in the historic district. These methods should continue in new construction. More modern materials may also be considered when they are compatible with those used historically.

7.10 New materials shall convey a sense of scale similar to that seen in historic materials.

- Appropriately scaled materials contribute to a visually interesting building facade.
- Large uninterrupted expanses of featureless materials are inappropriate.
- Metal framing can often be similar to that of wood frame methods and portray a similar scale while also reflecting modern construction methods.
- Lap siding shall be similar in depth and profile to historic materials.

7.11 Building materials shall have similar characteristics as materials used historically.

- Unfinished or reflective materials shall not be used.
- Polished stone and mirrored glass shall be avoided as primary materials.
- Synthetic materials are discouraged, but are most appropriate in upper floors where they are less accessible.
- Material color schemes should reflect historic patterns of one muted background color, with one or two other colors used as accents.

7.12 All materials used shall be durable and appropriate for the climate.

- Any new, alternative material should have a demonstrated durability in the Juneau context and shall be approved by the Community Development Department.



Although this new infill building meets basic regulations regarding height and orientation it does not reflect the character and building materials found in the district. Display windows should be continuous and have kickplates. The second story projection is out of scale and there is no belt course. See sketches on previous page for appropriate storefront examples.





This is a good example of an infill building, although the storefront could be refined to further reflect the architectural character of the district. The display windows could be increased and the kickplate could be reduced. Greater profile could be attained in the finish materials.

## Architectural Character

While it is important that new buildings and alterations be compatible with the historic context, they shall not imitate older building styles because this confuses the authenticity of the district. Visual compatibility results when the design variables in a new building are arranged to be similar to historic patterns in the area yet in ways that convey their own time. New construction shall be stylistically distinguishable from historic buildings while maintaining a similar scale and character-defining features to historic buildings.

7.13 New interpretations of traditional building styles are appropriate. Infill construction shall:

- Be a balance of new and old design.
- Draw upon the fundamental similarities among older buildings in the area without copying them. This will allow it to reflect its own time and yet be compatible with its historic neighbors.
- Avoid literal imitation of older historic styles.

7.14 A new building shall be compatible with architectural and scale-giving elements traditionally found in the district.

- Similar architectural massing as well as window and door patterns are examples of scale-giving elements.

7.15 Modern interpretations of architectural features historically used are appropriate in new construction.

- New construction shall include architectural features used historically in the district such as storefronts and canopies at the street level, but these shall not be direct copies of those seen historically.

New construction shall include architectural features used historically in the district such as storefronts and canopies at the street level, but these shall not be direct copies of those seen historically. Although this building complements the historic fabric, several steps could have been made to make it a better fit. This includes adding a kickplate and providing additional depth to the profile of the storefront, upper story windows, belt course and cornice.



---

## Facade Elements

### Storefronts

Storefronts are important character-defining features of the historic district, and shall be included on new buildings in the historic district.

- 7.16 The scale and proportions of a new storefront shall be similar to those seen historically.
- First floors shall be taller than upper floors.
- 7.17 Window patterns in storefronts shall be similar to those seen historically.
- The area of transparent material shall be roughly equal to what is seen historically.
- 7.18 Alternative designs that are contemporary interpretations of traditional storefronts may be considered.
- Modern designs that use traditional elements are appropriate.
  - The new design shall continue to convey the character of typical storefronts, including the transparent character of the display window.



A contemporary interpretation of a storefront including kickplate and canopy, which is appropriate.



The scale and proportion of storefront elements shall be similar to those seen historically.



A clearly defined entry is commonly covered by a canopy.

## Canopies

Canopies are noteworthy features of the historic district and have a strong history of use. Their inclusion in the design of new construction is required by the land use code.

### 7.19 Building canopies are required.

- Canopies help unify the streetscape as well as provide refuge from inclement weather.

### 7.20 Mount canopies to accentuate character-defining features and window openings.

- Canopies shall be mounted to highlight moldings that may be found above the storefront or within the storefront.
- The scale of canopies and their support systems shall be in proportion to the building, and not dominate the facade.

### 7.21 Use colors and materials that are compatible with the overall design of the building.

- Canopy materials shall reflect the style and character of the building.
- Use colors that are compatible with the overall color scheme of the facade. Solid colors or simple, muted stripe patterns are appropriate.
- 

### 7.22 Canopies shall step down to maintain a consistent height over the sidewalk.

- Canopies shall not be angled across the building facade.
- Some slope is appropriate to allow for run-off of precipitation.
- Articulation in awnings and canopies is appropriate to designate the main building entry.

### 7.23 Projecting horizontal canopies are most appropriate.

- The canopy shall fit the opening of the building.
- Odd shapes, bullnose awnings and bubble awnings are inappropriate on most structures.
- Internal illumination is inappropriate.
- Simple shed shapes may be considered in some cases.

---

## Balconies

Balconies may be provided as amenities where their use will not impact the integrity of the district.

7.24 Balconies may be considered on new structures where:

- They will not directly be directly visible from the public right-of-way, such as on the rear of a building.
- They will be supported by the building.
- Balconies are inappropriate where they will negatively impact the historic integrity of the district.

## Rooftop Uses

Rooftop uses such as patios, decks and outdoor dining may be provided as amenity spaces, however their location should not impact the quality or appearance of the streetscape.

7.25 Minimize the visual impact of rooftop uses as seen from the street.

- Setback rooftop activity areas such that they are not visible from the sidewalk below.
- Railings, umbrellas, tables and other patio furniture should not be visible from the street.

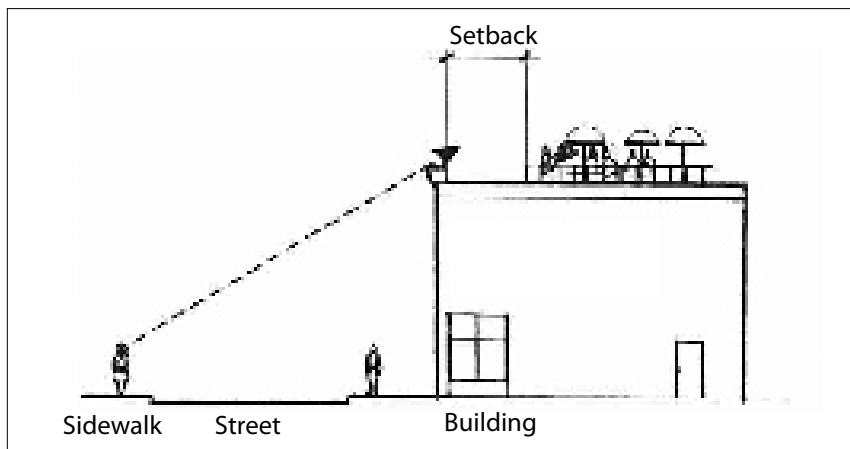

Rooftop use areas should not be visible from the sidewalk below.



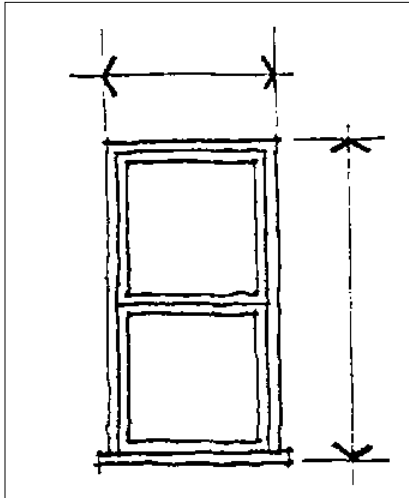

Typically, upper-story windows are twice as tall as they are wide. This tradition shall be continued. This may be expressed in a variety of ways. See the examples below.



Upper-story windows with vertical emphasis are required.

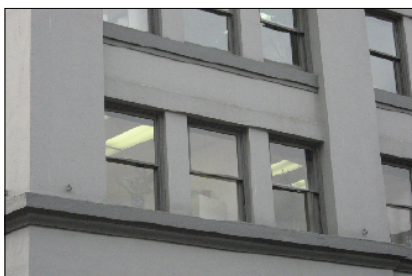

Traditionally windows have a sense of depth as seen here.

## Windows

A pattern exists along the streets with the repetition of evenly-spaced, similarly-sized, upper-story windows. These windows are often double hung, and help to give buildings a sense of human scale. Using window sizes and proportions that are familiar to the pedestrian helps them to relate to the overall size of a building. The alignment and similar scale of windows reflect a common historic pattern that shall be continued in new development.

7.26 Upper-story windows with a vertical emphasis are required.

- A typical upper-story window is approximately twice as tall as it is wide. Upper-story windows in new construction shall relate to the window proportions seen historically.
- A ganged double-hung window configuration is appropriate.

7.27 Windows shall align with others in a block.

- Windows, lintels and their trim elements shall align with traditional buildings on the block.

7.28 Materials used in and around windows shall be similar in scale and proportion to those used historically.

- Tinted or reflective glass is inappropriate.
- The use of wood windows is appropriate. The depth of the profile should be very similar to those seen historically.



Although this new infill building is appropriately scaled with buildings in the district, the window orientation, proportion, and alignment are inappropriate. The upper story windows are aligned higher than traditionally seen and the projecting central bay window and cornice are out of character. The display windows should be larger and be accompanied by kickplates.



---

## Entries

The repetition of recessed building entries occurring along the street in the historic district provides a rhythm of shadows along the street, which helps establish a sense of scale and invites pedestrians to enter buildings. This trend shall be continued in new construction.

7.29 A building entrance shall appear similar to those used historically.

- Clearly define the primary entrance.
- Recess the building entrance.
- Choose a design similar in scale and overall character to those seen historically for a contemporary interpretation of a traditional building entry.
- Place the primary building entrance at or near street level. A sunken terrace entrance is inappropriate as the primary access from the street.
- Design entries to have a high degree of transparency.

## Pedestrian Interest

The Downtown Historic District shall continue to develop as a pedestrian-oriented environment of ground floor storefronts. Buildings shall relate to pedestrians by using materials and a human scale compatible with local historic patterns. The ground floor shall also provide year-round interest, not solely in the peak season.

7.30 Develop the ground floor level of a project to encourage pedestrian activity.

- Provide a storefront along a primary pedestrian way when feasible.
- Provide a protective canopy over the sidewalk similar to surrounding buildings.
- Provide architectural detailing that is pedestrian scaled on first floor facades.

7.31 Avoid blank walls or the appearance of a vacant lot.

- Design all building facades that can be seen by pedestrians to be visually interesting.
- Provide repetitive elements, such as windows and belt courses, to create a rhythm of shadows along a facade. This helps establish a sense of scale and interest for pedestrians.
- Use architectural detailing and material articulation to create a visually pleasing facade.



---

# Chapter 8

## Design Guidelines for Site Design and the Public Streetscape

Juneau has an active downtown where pedestrians share streets with buses, automobiles and bicycles. This mix of traffic can provide a sense of excitement and enhance the pedestrian experience if all the elements are kept in balance. A unified streetscape design for the historic district will help maintain a sense of visual continuity while expressing the unique qualities of the Downtown Historic District. The following guidelines are applicable to new development and changes to existing non-contributing buildings in Downtown Juneau.



Juneau's active downtown streets.



Juneau's active downtown street scene.

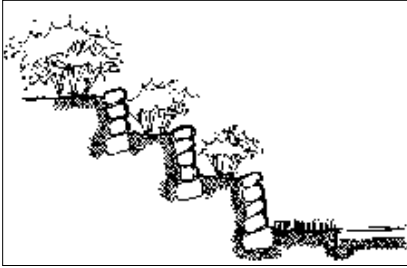

Use earth berms, rock forms or stone retaining walls to minimize visual impacts of hillside cuts. Use a series of terraces with short walls to maintain the traditional sense of a hillside where feasible.

## Cut and Fill

Site development may require cutting into relatively steep slopes along with substantial excavations for foundations. While basic engineering concerns are major issues in these cases, the visual impacts of these cuts can be significant. To the greatest extent possible, cutting-and-filling of sloping areas shall be avoided but, where it must occur, the visual impacts shall be minimized.

- 8.1 Minimize cut-and-fill excavation that would alter the perceived natural topography.
- Use earth berms or retaining walls to minimize visual impacts of cuts. Hedges and fences may also be appropriate in some locations.
  - Simple rock walls may be considered. Exposed gabions, large, continuous surfaces of smooth raw concrete and similar structures shall be avoided.

## Site Retaining Walls

Simple retaining walls are used in some areas where steep slopes occur.

- 8.2 New retaining walls shall use natural materials.
- Architectural block, with special texturing or color may be considered where it can be demonstrated that the result will appear to be in character with the area.
- 8.3 Minimize the perceived scale and mass of a new retaining wall.
- A wall that is less than four feet is appropriate and encouraged.
  - Where the overall retaining height must be greater than four feet, use a series of terraces with short walls to maintain the traditional sense of a hillside where feasible.
  - Consider varying the setback of individual walls to minimize the perceived overall width of a long wall.
  - Consider varying masonry patterns to provide variety in large walls where applicable.

## Building and Site Lighting

The primary function of lighting is for safety and security. Lighting is also used to accent building character and for advertising and sales promotion. The primary goal for lighting in Juneau is that it shall not be detrimental to the adjacent surroundings or the overall environment, but shall still maintain a safe environment. Lighting the sidewalk sufficiently is a goal within the district. This does not imply high levels of illumination; minimum illumination levels are more appropriate for various nighttime functions.

The character and level of lighting that is used on a building is of special concern. Traditionally, exterior lights were simple in character and were used to highlight signs, entrances and first floor details. Most fixtures had incandescent lamps that cast a color similar to daylight, were relatively low in intensity and were shielded with simple shade devices. Although new lamp types may be considered, the overall effect of modest, focused building light shall be continued.

- 8.4 Exterior lighting shall accent, not dominate, a building facade.
- Primary building entrances shall be the main source of illumination.
  - Secondary accents may illuminate secondary entrances, architectural details and signs.
  - The use of strobe lighting is inappropriate.
  - Seasonal string lighting is appropriate.
  - Secondary accents that may illuminate other areas of public and functional importance, such as side or rear entrances, steps and walks located along the side of the building, may be appropriate.
  - The use of recessed downlighting in canopies is appropriate.
- 8.5 Minimize the visual impacts of site and architectural lighting.
- Use exterior light sources with a low level of luminescence.
  - Use white lights that cast a similar color to daylight.
  - Do not wash an entire building facade in light.
  - Use lighting fixtures that are compatible with and complimentary to the building and its surroundings in terms of style, scale and intensity of illumination.
  - Blinking, flashing lights and exposed strip lighting used to illuminate building facades or to outline buildings are inappropriate.
  - Interior lights to illuminate signs or canopies are inappropriate.
- 8.6 Use shielded and focused light sources to prevent glare.
- Provide shielded and focused light sources that direct light downward.
  - Do not use high intensity light sources or cast light directly upward.
  - Shield lighting associated with service areas, parking lots and parking structures.



Exterior lights should be simple in character and used to highlight signs, entrances, sidewalk and first floor details.



Prevent glare onto adjacent properties by using shielded and focused light sources that direct light onto the ground. The use of downlights, with the bulb fully enclosed within the shade, or step lights which direct light only to walkways, is strongly encouraged.



A sconce above the sign is an appropriate example of an exterior lighting fixture.





Extensive canopy, awning, and porch lighting is inappropriate. (Lahaina, HI)

- 8.7 Minimize impacts from service and parking area lighting.
- Security and service area lighting shall be discriminately utilized to illuminate the area for surveillance as required, yet it shall be prevented from creating a hot spot of light calling attention to it from the surrounding areas.
  - Keep parking area lighting at a human scale.
  - All parking light fixtures shall be similar in design and shall be spaced throughout the parking area to avoid regimented placement.
- 8.8 Street lighting fixtures shall be consistent throughout the district.
- Unique and consistent street lighting fixtures help to unify the streetscape of the downtown and to mark the boundaries of the historic district.
- 8.9 Extensive canopy, awning and porch lighting is inappropriate.
- Lighting on the underside of a canopy is appropriate when it does not dominate the streetscape.
  - Attach light fixtures to the building facade rather than the underside of a canopy or awning.



Mechanical equipment such as satellite dishes can detract from the historic character of the downtown when visible from public right-of-ways.

## Mechanical Equipment and Service Utilities

Utility service boxes, external fire connections, telecommunication devices, cables, conduits, trash and recycling storage, satellite dishes and fans may affect the character of an area. These devices shall be screened from public view to avoid negative effects on historic resources.

- 8.10 Minimize the visual and noise impacts of mechanical equipment on the public way and surrounding neighborhood.
- Screen equipment from view.
  - Do not locate window equipment on a primary facade.
  - Use low-profile or recessed mechanical units on rooftops.
  - Locate satellite dishes out of public view.
  - When feasible locate equipment away from adjacent residential properties and/or buffer it. Additional noise attenuation measures should be taken if the equipment noise exceeds national standards.
- 8.11 Minimize the visual impacts of utility connections and service boxes.
- Locate utility connections and service boxes on secondary walls when feasible.
- 8.12 Minimize the visual impacts of trash storage and service areas.
- Locate service areas away from major pedestrian routes; locate them at the rear of a building, off an alley, when possible.
  - Screen dumpsters from view.

## Street Furnishings

Several areas of Downtown Juneau already have amenities in place that enhance the pedestrian experience. New furnishings shall continue to enhance the area while working with existing features. Where feasible, benches, planters, lighting, mail boxes, newspaper racks and trash receptacles shall be located in a “furnishings zone” which maintains a clearly defined pedestrian travel lane.

8.13 All street furniture in the public right-of-way shall have similar materials and finishes.

- Draw upon local character and materials for street furniture design.

8.14 Street furnishings shall be simple in character.

- Avoid highly ornate designs which could misrepresent the history of the area.



Street furnishing shall be simple in character, such as this bench.



Street furnishings such as these decorative light fixtures can add to the character of the streetscape.



Decorative paving can help to define key intersections and aid in way finding.

## Sidewalks

Early photographs of Downtown Juneau show simple concrete sidewalks which provide a visual unity to the area. This tradition shall be continued. A clear and safe pedestrian travel lane shall be kept clear of all merchandise.

8.15 Sidewalk design shall reflect the character of its historic context.

- Sidewalk designs shall be modest in character
- Sidewalks shall be attached to the curb.

8.16 The main sidewalk paving shall be a simple concrete finish.

- Broom-finished, grey concrete is preferred for the predominant material.
- Decorative paving may be used to define special functional areas such as key intersections, public plazas and courtyards.
- The finish texture should comply with current accessibility requirements.

8.17 Decorative and accent paving is appropriate for key crosswalks.

- Decorative paving at key intersections can help unify the streetscape and aid in way finding throughout the district.
- Although decorative paving is appropriate for accents at intersections, the goal for the rest of the sidewalk treatments in the district should read as a cohesive system.

8.18 Merchandise displayed on the sidewalk shall be kept clear of the public right-of-way.

- Merchandise such as hanging racks and display tables that occur outside of the building are not in character with the district, and shall be set back three feet from the storefront entrance.



Early photographs of Downtown Juneau show simple concrete sidewalks.

---

## ATMs

An ATM should be located inside a building when feasible. When not possible an ATM should be synthesized into a building's secondary facade. The visual impact of freestanding ATMs should be minimized.

8.19 An ATM should be located inside a building or integrated into a building's facade, when feasible.

- An ATM should complement the exterior building facade.
- Position an ATM on a secondary wall when feasible.
- A muted color that complements the building should be considered.

8.20 Minimize the visual impact of ATM machines.

- Use a low-profile unit.
- Large scale freestanding enclosures with canopies are inappropriate within the district.
- Bold contrasting colors on machines are inappropriate.



Large scale freestanding enclosures with canopies are inappropriate within the district.





---

# Chapter 9

## Design Guidelines for Parking Facilities

Utilizing alternative modes of transportation is encouraged in Downtown Juneau; however, parking is still necessary. When accommodating parking in the downtown the primary goal is to minimize visual impacts.

### Surface Parking

- 9.1 Surface parking should be located in the interior of a block whenever possible.
- Do not place surface lots on corner properties as they are generally more visible than interior lots and provide a sense of enclosure for intersections.
  - Site a surface lot to minimize gaps in the street wall.
  - Place the parking to the rear of a building to preserve the architectural continuity of the street.
- 9.2 Provide a visual buffer where surface lots abut sidewalks.
- Consider the use of a compatible wall as a screen near the edge of the lot.
  - Use a combination of trees and shrubs to create a landscape buffer.



Parking lot providing landscaped visual buffer where it abuts a public sidewalk. (Ann Arbor, MI)

### Security and Pedestrian Circulation in Parking Facilities

- 9.3 Design parking facilities to be accessible to pedestrians.
- Clearly define walkways with graphics, lighting or landscaping.
  - Provide a direct connection between parking structures and supporting businesses.
  - Plan interior and exterior lighting to assure user safety.



The ground level of a parking structure should be wrapped by retail, office or some other active use along the street edge, or parking should be stacked above an active street level use.



This parking structure incorporates a wrap of retail stores along the street edge. The storefronts are contemporary interpretations of historic downtown storefronts. (Boulder, CO)

## Parking Structures

Parking structures should be designed to enhance pedestrian activity along the street in the historic district. At a minimum a parking structure should help to animate the street and be compatible with the surrounding historic context. The visual impacts of the cars themselves should be minimized.

- 9.4 Design a parking structure so that it creates an attractive, active street edge.
- Wrap parking structures with retail space or other active use along the street edge, or stack them over an active street level use when feasible in order to shield the facility from the street.
  - Provide visually attractive street edges with architectural detailing, murals, public art, landscaping and product display cases when a retail wrap is not feasible.
- 9.5 Design parking structures to be compatible with historic buildings in the surrounding area.
- Respect the character-defining features of adjacent historic buildings.
  - Maintain the alignment and rhythm of architectural features as seen along the street.
  - Use similar building materials.
  - Avoid multiple curb cuts which complicate turning movements and disrupt the sidewalk.
  - Reflect the traditional widths of buildings in the area.

# Chapter 10

## Design Guidelines for Signs

A sign typically serves two functions: to attract attention and to convey information. All signs shall be consistent with the building's period of significance. All new signs shall be developed with the overall context of the building and of the area in mind. Signs shall be constructed in a manner that does not damage the historic fabric of the building.

See also:  
City and Bureau of Juneau Land Use Code Chapter 49.45 Signs Article I, Article II, Article III and Article IV.

### Appropriate Sign Types

Sign types vary widely in the Downtown Historic District. The important principle is that signs do not overwhelm the architecture of the building. The placement, location and type of a sign are perhaps the most critical factors in maintaining the order and integrity of the district. Consistent placement of signs according to building type, size, location and even building materials creates a sense of visual continuity. The use of roof-top signs of any kind are prohibited. The following sign types are acceptable in the Downtown Historic District.



#### 10.1 Canopy Signs

A canopy sign is a sign attached or applied to the horizontal face of a canopy. Canopy signs shall not extend below the bottom of the horizontal face or more than one foot above the horizontal face of the canopy. A sign located on a canopy face may be appropriate:

- In areas with high pedestrian use.
- When other signs would obscure architectural details of the structure.

The only sign appearing above the canopy or first floor level of a building should relate to the name of the building or principal use within the building.

#### 10.2 Under Canopy Hanging Signs

An under canopy hanging sign is a sign that hangs from the underside



A canopy sign should not extend below the bottom of the horizontal face or more than 1' above the horizontal face.



Under canopy hanging signs.

of a canopy or building projection, and does not employ ground support in any matter. One under canopy hanging sign is allowed per tenant per street facade. A sign of this type shall be designed and located in a similar fashion to other under canopy hanging signs on the same building, and shall:

- Incorporate sign brackets as a decorative or complementary element of the sign and building detail.
- Be located near the business entrance, just above the door or to the side of it.

Note: All pertinent regulations should be reviewed when planning to use an under canopy hanging sign on a canopy that overhangs a public right-of-way

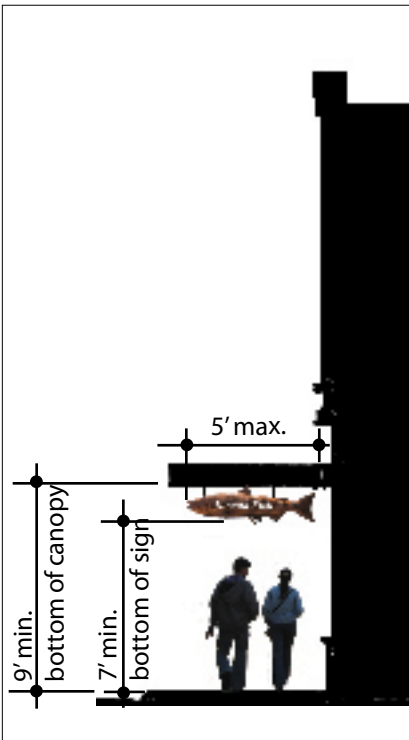

An under canopy hanging sign is encouraged. These signs shall not extend more than 5' from the facade front, nor shall they be less than 7' from above the finished sidewalk.

### 10.3 Facade Mounted Signs

A facade mounted sign is a sign that is attached to the wall or surface of a building, which is parallel to the supporting surface. When designing and locating a sign of this type:

- Place the sign relatively flush with the building facade and align it with others signs on the building.
- Place the sign within, rather than forward of, the fascia or other architectural details of the building. Decorative moldings and architectural details of the building should be used to define a sign, by locating the sign within a panel formed by moldings or transom panels.
- Place the sign in a manner that does not obstruct character-defining features of the building.

### 10.4 Window or Doors Signs

A window or door sign is a sign that is painted on, adhered to and/or displayed through a window or door with the intent to be viewed from the outside. When using this type of signage the following criteria shall apply:

- Window or door signs may occupy 10% of the storefront glass and are only allowed on the first floor of a building. All window and door signage in excess of the allowable 10% of the storefront glass shall be counted against the overall allowed sign area for that side of the building (See graphic page 67).

### 10.5 Historic Building Names

A historic building name or sign that is a significant part of the historic building, may contribute to the historic significance of the building and as such shall be preserved and not removed.

## Sign Composition

The composition of a sign in contrast to a building's architectural detail and design are important to preserving the significance or integrity of a historic building. When designing and installing a sign the following

shall apply:

- 10.6 Signs shall be subordinate to the overall building composition.
- Scale signs to fit with the facade of the building.
  - Locate a sign to emphasize design elements of the facade itself.
  - Mount signage to fit within existing architectural features using the shape of the sign to help reinforce the horizontal lines of moldings and transoms seen on the building.
  - Calculate the sign area by using simple geometric shapes that define the sign.
  - Though not widely done historically, the use of symbols to portray a word, name, or idea may be considered.
  - Rooftop signs are inappropriate. This includes stand-alone or painted on signs.
- 10.7 A corporate logo or color scheme may be incorporated into signage as long as signs of this nature do not alter or destroy existing architectural features or details.
- The Community Development Department Director shall determine the portion of the building that will be recognized as part of a corporate design, and therefore a sign.



An irregularly shaped sign area is calculated by a simple geometrical shape juxtaposed on the object.



The total window and door sign area should not exceed 10% of the total storefront glass (grayed area). The maximum window and door sign area is shown in this example.



- See NPS Preservation Brief 25: The Preservation of Historic Signs, for further information.

## Sign Character

When designing a sign that will be erected in the historic district consideration shall be given to the proposed materials, colors and details of the sign and the building on which the sign is to be installed.



A sign shall be clearly legible.

- 10.8 Signs shall be designed in a manner that doesn't damage the historic fabric of the building.
  - Any sign that visually overpowers the building or obscures significant views or architectural features is inappropriate.
- 10.9 A simple sign design is preferred.
  - Typefaces that are in keeping with those seen in historic photos or that are traditionally used are encouraged. Modern typefaces are inappropriate.
  - Avoid hard-to-read or overly intricate typeface styles.
  - Consider letter and painted signs on blank walls as they were used historically.

## Sign Materials

A sign's material shall reflect the style of the building to which it is attached and its period of significance (see Chapter 2).

- 10.10 Use signage materials that are compatible with the building facade.
  - Signs shall be wood, sign-grade foam, or metal.
  - Other materials may be used as long as the material is durable and does not have a plastic appearance.
  - Signs shall be painted and shall have a matte surface finish. The use of vinyl covers or stickers are inappropriate, except in the instance of window and door signs.
  - Highly reflective materials shall not be used.

## Sign Lighting

The sign illumination source shall be shielded to minimize glare. Light intensity shall not overpower the building or street edge. Small and discreet modern light fittings may provide an unobtrusive alternative to traditionally styled lamp units.

- 10.11 Use indirect lighting on signage.
  - Direct the lighting at signage from an external, shielded lamp.
  - Warm lighting, similar to daylight, is appropriate.
  - Strobe lighting is inappropriate.
  - Internal illumination is inappropriate.
  - Halo illumination is inappropriate.

## Sign Installation

The installation of a sign is an integral aspect in the retention of key

---

architectural features and in minimizing damage to the building.

10.12 Avoid damaging or obscuring architectural details or features when installing signs.

- Minimize the number of anchor points when feasible.
- Install signs in a manner that does not create a public safety hazard.

## Sign Color

The use of color in sign design shall be assessed in the context of the building, as well as the area, scale and form of the sign. Strong primary colors shall be used sparingly and primarily for accent purposes. Sign panels shall avoid areas of white or cream, which visually detach the sign from the building. Color shall be used to accentuate the sign design and message, and to integrate the sign with the building.

10.13 Use colors for the sign that are generally compatible with those of the building front.

- In general, no more than three main colors shall be used, although small amounts of additional accent colors may be appropriate.
- Use colors and materials that are compatible with the overall color scheme of the facade
- Select colors that offer contrast and legibility.



Appropriate under canopy hanging signs.

---

---

# Chapter 11

## Design Guidelines for Off-season Display Windows

Downtown Juneau is a seasonal tourist destination; this creates occupancy issues because many businesses close during the off-season. Upon closing, tenants and/or business owners screen windows with butcher paper or similar types of materials to convey closure. This type of treatment has a negative impact on the streetscape, including a perception of abandonment. Exterior and interior lights are also extinguished, reinforcing the sense of closure along the street. A more appropriate approach is to consider installing a temporary window display that could block views to the interior of the store, but also convey information. For example, an interpretive photo display could be one approach that could solve this issue. Low levels of illumination could light the panels throughout the evening hours. Exterior lights that help to illuminate the sidewalk should also be maintained throughout the year. These efforts would enhance the streetscape and create a pedestrian-friendly environment year-round.

### 11.1 Display windows shall provide year-round interest.

- Windows covered by newspaper, boards or blank coverings are inappropriate (For example, a pictorial history of Juneau or the building's past can be made for display during the off-season. This can take the form of banners or display boards.)







---

# Appendix A

## The Secretary of the Interior's Standards for the Rehabilitation of Historic Buildings

The Secretary of the Interior's Standards for the Rehabilitation of Historic Buildings are general rehabilitation guidelines established by the National Park Service. These standards are policies that serve as a basis for the design principles presented in this document. The Secretary's Standards state that:

1. A property shall be used as it was historically or be given a new use that requires minimal change to its distinctive materials, features, spaces, and spatial relationships.
2. The historic character of a property shall be retained and preserved. The removal of distinctive materials or alteration of features, spaces, and spatial relationships that characterize a property shall be avoided.
3. Each property shall be recognized as a physical record of its time, place, and use. Changes that create a false sense of historical development, such as adding conjectural features or elements from other historic properties, shall not be undertaken.
4. Changes to a property that have acquired historic significance in their own right shall be retained and preserved.
5. Distinctive materials, features, finishes, and construction techniques or examples of craftsmanship that characterize a property shall be preserved.
6. Deteriorated historic features shall be repaired rather than replaced. Where the severity of deterioration requires replacement of a distinctive feature, the new feature shall match the old in design, color, texture, and, where possible, materials. Replacement of missing features shall be substantiated by documentary and physical evidence.
7. Chemical or physical treatments, if appropriate, shall be undertaken using the gentlest means possible. Treatments that cause damage to historic materials shall not be used.
8. Archeological resources shall be protected and preserved in place. If such resources must be disturbed, mitigation measures shall be undertaken.

- 
9. New additions, exterior alterations, or related new construction shall not destroy historic materials, features, and spatial relationships that characterize the property. The new work shall be differentiated from the old and shall be compatible with the historic materials, features, size, scale and proportion, and massing to protect the integrity of the property and its environment.
  10. New additions and adjacent or related new construction shall be undertaken in such a manner that, if removed in the future, the essential form and integrity of the historic property and its environment would be unimpaired.

Design for alterations and additions to existing properties should not be discouraged when such alterations and additions do not destroy significant historical, architectural or cultural material. Such design should be compatible with the size, scale, color, material and character of the property, neighborhood and environment.

---

# Appendix B

## Historic Preservation Briefs

The Cultural Resources Department of the National Park Service, in the U.S. Department of the Interior, started a program in 1975 in which it has continued to publish a series of technical reports regarding proper preservation techniques. This series, Preservation Briefs, is a mainstay for many preservationists in the field. When considering a preservation project on any historic property these resources should be sought out.

Mack, Robert C. Preservation Briefs 1: The Cleaning and Waterproof Coating of Masonry Buildings. Washington, D.C.: U.S. Government Printing Office, 1975.

Mack, Robert C., de Teel Patterson Tiller and James S. Askins. Preservation Briefs 2: Repointing Mortar Joints in Historic Brick. Washington, D.C.: U.S. Government Printing Office, 1980.

Baird, Smith M. Preservation Briefs 3: Conserving Energy in Historic Buildings. Washington, D.C.: U.S. Government Printing Office, 1978.

Sweetser, Sarah M. Preservation Briefs 4: Roofing for Historic Buildings. Washington, D.C.: U.S. Government Printing Office, 1978.

U.S. Department of the Interior. Preservation Briefs 5: Preservation of Historic Adobe Buildings. Washington, D.C.: U.S. Government Printing Office, 1978.

Grimmer, Anne E. Preservation Briefs 6: Dangers of Abrasive Cleaning to Historic Buildings. Washington, D.C.: U.S. Government Printing Office, 1979.

Tiller, de Teel Patterson. Preservation Briefs 7: The Preservation of Historic Glazed Architectural Terra-Cotta. Washington, D.C.: U.S. Government Printing Office, 1979.

Myers, John H., revised by Gary L. Hume. Preservation Briefs 8: Aluminum and Vinyl Siding on Historic Buildings. Washington, D.C.: U.S. Government Printing Office, 1978.

Myers, John H. Preservation Briefs 9: The Repair of Historic Wooden Windows. Washington, D.C.: U.S. Government Printing Office, 1981.

Weeks, Kay D. and David W. Look. Preservation Briefs 10: Exterior Paint Problems on Historic Woodwork. Washington, D.C.: U.S. Government Printing Office, 1982.

---

Jandl, H. Ward. Preservation Briefs 11: Rehabilitating Historic Storefronts. Washington, D.C.: U.S. Government Printing Office.

U.S. Department of the Interior. Preservation Briefs 12: The Preservation of Historic Pigmented Structural Glass. Washington, D.C.: U.S. Government Printing Office, 1984.

Park, Sharon C. Preservation Briefs 13: The Repair and Thermal Upgrading of Historic Steel Windows. Washington, D.C.: U.S. Government Printing Office.

Weeks, Kay D. Preservation Briefs 14: New Exterior Additions to Historic Buildings: Preservation Concerns. Washington, D.C.: U.S. Government Printing Office, 1986.

Coney, William B. and Wiss, Janney, Elstner Associates, Inc. Preservation Briefs 15: Preservation of Historic Concrete: Problems and General Approaches. Washington, D.C.: U.S. Government Printing Office.

Park Sharon C. Preservation Briefs 16: The Use of Substitute Materials on Historic Building Exteriors. Washington, D.C.: U.S. Government Printing Office.

Nelson, Lee H. Preservation Briefs 17: Architectural Character: Identifying the Visual Aspects of Historic Buildings as an Aid to Preserving Their Character. Washington, D.C.: U.S. Government Printing Office.

Jandl, H. Ward. Preservation Briefs 18: Rehabilitating Interiors in Historic Buildings. Washington, D.C.: U.S. Government Printing Office, 1988.

Park Sharon C. Preservation Briefs 19: The Repair and Replacement of Historic Wooden Shingle Roofs. Washington, D.C.: U.S. Government Printing Office.

Auer, Michael J. Preservation Briefs 20: The Preservation of Historic Barns. Washington, D.C.: U.S. Government Printing Office, 1989.

MacDonald, Marylee. Preservation Briefs 21: Repairing Historic Flat Plaster—Walls and Ceilings. Washington, D.C.: U.S. Government Printing Office, 1989.

Grimmer, Anne. Preservation Briefs 22: The Preservation and Repair of Historic Stucco. Washington, D.C.: U.S. Government Printing Office, 1990.

Flaharty, David. Preservation Briefs 23: Preserving Historic Ornamental Plaster. Washington, D.C.: U.S. Government Printing Office, 1990.

---

Park, Sharon C. Preservation Briefs 24: Heating, Ventilating, and Cooling Historic Buildings: Problems and Recommended Approaches. Washington, D.C.: U.S. Government Printing Office, 1991.

Auer, Michael J. Preservation Briefs 25: The Preservation of Historic Signs. Washington, D.C.: U.S. Government Printing Office, 1991.

Bomberger, Bruce D. Preservation Briefs 26: The Preservation and Repair of Historic Log Buildings. Washington, D.C.: U.S. Government Printing Office, 1991.

Waite, John G. Preservation Briefs 27: The Maintenance and Repair of Architectural Cast Iron. Washington, D.C.: U.S. Government Printing Office, 1991.

Chase, Sara B. Preservation Briefs 28: Painting Historic Interiors. Washington, D.C.: U.S. Government Printing Office, 1992.

Levine, Jeffrey S. Preservation Briefs 29: The Repair, Replacement, and Maintenance of Historic Slate Roofs. Washington, D.C.: U.S. Government Printing Office, 1992.

Grimmer, Anne E. and Paul K. Williams. Preservation Briefs 30: The Preservation and Repair of Historic Clay Tile Roofs. Washington, D.C.: U.S. Government Printing Office, 1992.

Park, Sharon C. Preservation Briefs 31: Mothballing Historic Buildings. Washington, D.C.: U.S. Government Printing Office, 1993.

Jester, Thomas C. and Sharon C. Park. Preservation Briefs 32: Making Historic Properties Accessible. Washington, D.C.: U.S. Government Printing Office, 1993.

Vogel, Neal A. and Rolf Achilles. Preservation Briefs 33: The Preservation and Repair of Historic Stained and Leaded Glass. Washington, D.C.: U.S. Government Printing Office, 1993.

Thornton, Jonathan and William Adair. Preservation Briefs 34: Applied Decoration for Historic Interiors: Preserving Composition Ornament. Washington, D.C.: U.S. Government Printing Office, 1994.

McDonald, Travis C. Preservation Briefs 35: Understanding Old Buildings: The Process of Architectural Investigation. Washington, D.C.: U.S. Government Printing Office, 1994.

Birnbaum, Charles A. Preservation Briefs 36: Protecting Cultural Landscapes: Planning, Treatment and Management of Historic Landscapes. Washington, D.C.: U.S. Government Printing Office, 1994.



---

Park, Sharon C. and Douglas Hicks. Preservation Briefs 37: Appropriate Methods for Reducing Lead Paint Hazards in Historic Housing. Washington, D.C.: U.S. Government Printing Office, 1995.

Weaver, Martin E. Preservation Briefs 38: Removing Graffiti from Historic Masonry. Washington, D.C.: U.S. Government Printing Office, 1995.

Park, Sharon C. Preservation Briefs 39: Holding the Line: Controlling Unwanted Moisture in Historic Buildings. Washington, D.C.: U.S. Government Printing Office, 1994.

Grimmer, Anne E. and Kimberly A. Konrad. Preservation Briefs 40: Preserving Historic Ceramic Tile Floors. Washington, D.C.: U.S. Government Printing Office, 1995.

Look, David W., AIA, Terry Wong, P.E., and Sylvia Rose Augustus. Preservation Brief 41: The Seismic Retrofit of Historic Buildings. Washington, D.C.: U.S. Government Printing Office, 1997.

Piper, Richard. Preservation Brief 42: The Maintenance, Repair and Replacement of Cast Stone. Washington, D.C.: U.S. Government Printing Office, 1995.

Slaton, Deborah. Preservation Brief 43: The Preparation and Use of Historic Structures Report. Washington, D.C.: U.S. Government Printing Office, 2004.

Randl, Chad. Preservation Brief 44: The Use of Awnings on Historic Buildings Repair, Replacement & New Design. Washington, D.C.: U.S. Government Printing Office, 2004.

Leeke, John and Aleca Sullivan. Preservation Briefs 45: Preserving Historic Wooden Porches. Washington, D.C.: U.S. Government Printing Office, 2006.

Randl, Chad. Preservation Briefs 46: The Preservation and Reuse of Historic Gas Stations. Washington, D.C.: U.S. Government Printing Office, 2006.

---

# Appendix C

## Glossary of Terms

**Alignment.** The arrangement of objects along a straight line.

**Appurtenances.** An additional object added to a building; typically includes vents, exhausts hoods, air conditioning units, etc.

**Asphalt Shingles.** A type of roofing material composed of layers of saturated felt, cloth or paper, and coated with a tar, or asphalt substance, and granules.

**Belt Course.** A horizontal board across or around a building usually enhanced with decorative molding.

**Board and Batten.** Vertical plank siding with joints covered by narrow wood strips.

**Bracket.** A supporting member for a projecting element or shelf, sometimes in the shape of an inverted L and sometimes as a solid piece or a triangular truss. (figure 1)

**Building.** A resource created principally to shelter any form of human activity, such as a house.

**Canopy.** A rooflike projection or shelter that projects from the facade of a building over the sidewalk.

**Clapboards.** Narrow, horizontal, overlapping wooden boards, usually thicker along the bottom edge, that form the outer skin of the walls of many wood frame buildings. The horizontal lines of the overlaps generally are from four to six inches apart in older houses.

**Composition Shingles.** See asphalt shingles.

**Coping.** The protective uppermost course of a wall or parapet. (figure 2)

**Cornice.** The continuous projection at the top of a wall. The top course or molding of a wall when it serves as a crowning member. (figure 3)

**Doorframe.** The part of a door opening to which a door is hinged. A doorframe consists of two vertical members called jambs and a horizontal top member called a lintel or head.

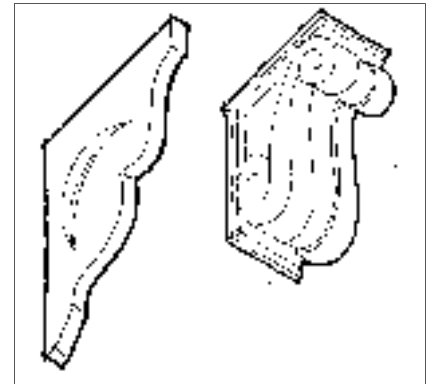

fig. 1

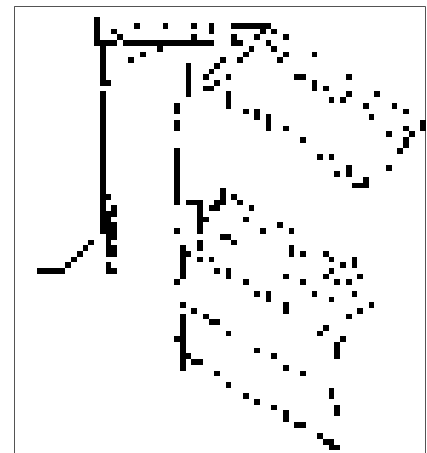

fig. 2

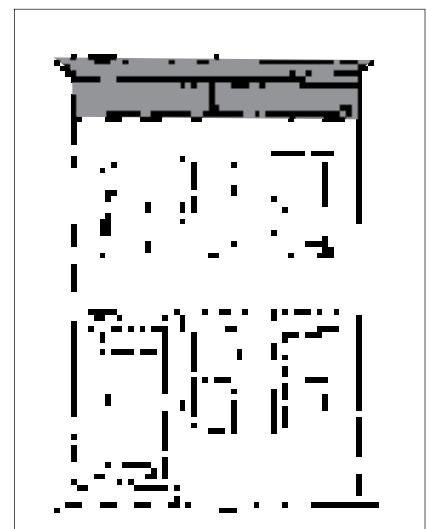

fig. 3

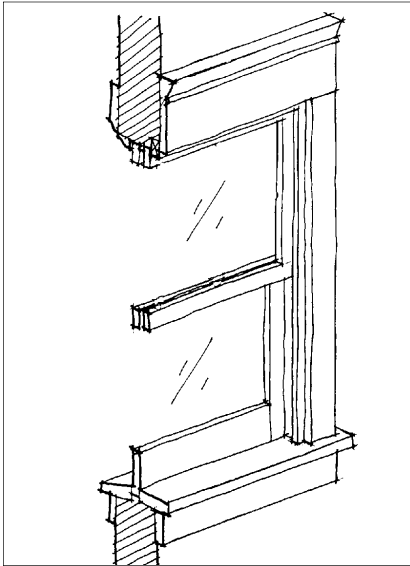

fig. 4

**Double-Hung Window.** A window with two sashes (the framework in which window panes are set), each moveable by a means of cords and weights. (figure 4)

**Eave.** The underside of a sloping roof projecting beyond the wall of a building. (figure 5)

**Elevation.** A mechanically accurate, “head-on” drawing of a face of a building or object, without any allowance for the effect of the laws of perspective. Any measurement on an elevation will be in a fixed proportion, or scale, to the corresponding measurement on the real building.

**Facade.** Front or principal face of a building, any side of a building that faces a street or other open space.

**Fascia.** A flat board with a vertical face that forms the trim along the edge of a flat roof, or along the horizontal, or “eaves,” sides of a pitched roof. The rain gutter is often mounted on it.

**Fenestration.** The arrangement of windows and other exterior openings on a building.

**Form.** The overall shape of a structure (i.e., most structures are rectangular in form).

**Frame.** A window component. See window parts.

**Gable.** The portion, above eave level, of an end wall of a building with a pitched or gambrel roof. In the case of a pitched roof this takes the form of a triangle. The term is also used sometimes to refer to the whole end wall.

**Glazing.** Fitting glass into windows and doors.

**Head.** The top horizontal member over a door or window opening. (figure 6)

**Historic District.** A geographically definable area of urban or rural character, possessing a significant concentration or continuity of site, building, structures or objects unified by past events or aesthetically by plan or physical development.

**Historic Resource.** A structure or streetscape that is unique to its period of significance and as such is to be wisely managed for the benefit of present and future generations.

**In-Kind Replacement.** To replace a feature of a building with materials of the same characteristics, such as material, texture, color, etc.

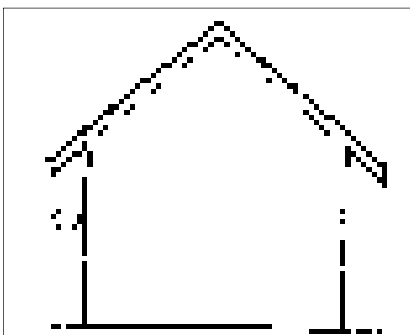

fig. 5

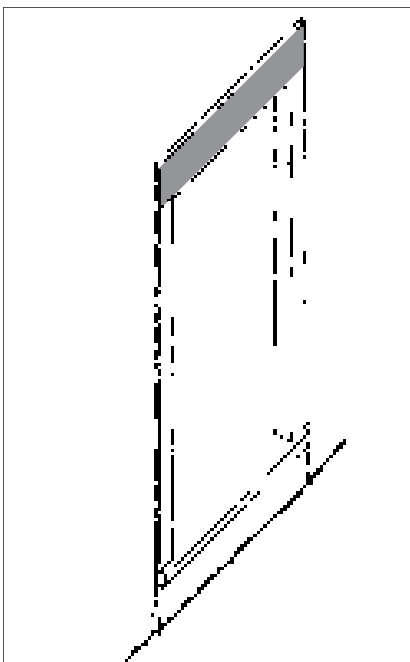

fig. 6

**Integrity.** A property retains its integrity, if a sufficient percentage of the structure dates from the period of significance. The majority of a building's structural system and materials should date from the period of significance and its character defining features also should remain intact. These may include architectural details, such as dormers and porches, ornamental brackets and moldings, as well as the overall mass and form of the building.

**Kickplate.** Found beneath the display window. Sometimes called bulkhead panel. (figure 7)



fig. 7

**Landmark.** Any of the following which have a special historical, architectural, cultural, aesthetic or engineering interest or value of a historical nature:

1. An individual structure or portion thereof;
2. An integrated group of structures on a single lot;
3. A site, or portion thereof; or
4. Any combination thereof.

**Lap Siding.** See clapboards.

**Mass.** The physical size and bulk of a structure.

**Masonry.** Construction materials such as stone, brick, concrete block or tile.

**Material.** As related to the determination of "integrity" of a property, material refers to the physical elements that were combined or deposited in a particular pattern or configuration to form a historic resource.

**Module.** The appearance of a single facade plane, despite being part of a larger building. One large building can incorporate several building modules.

**Molding.** A decorative band or strip of material with a constant profile or section designed to cast interesting shadows. It is generally used in cornices and as trim around window and door openings. (figure 8)

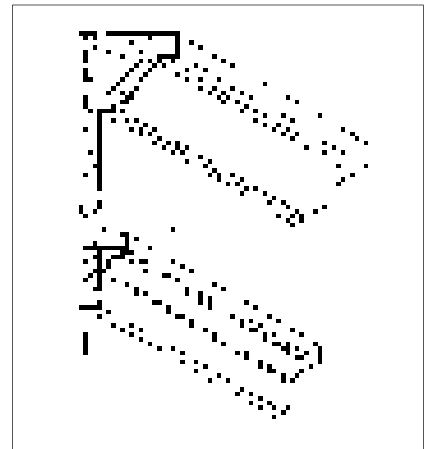

fig. 8

**Muntin.** A bar member supporting and separating panes of glass in a window or door.

**Opaque Fence.** A fence that one cannot see through.

**Orientation.** Generally, orientation refers to the manner in which a building relates to the street. The entrance to the building plays a large role in the orientation of a building; whereas, it should face the street.

**Panel.** A sunken or raised portion of a door with a frame-like border.

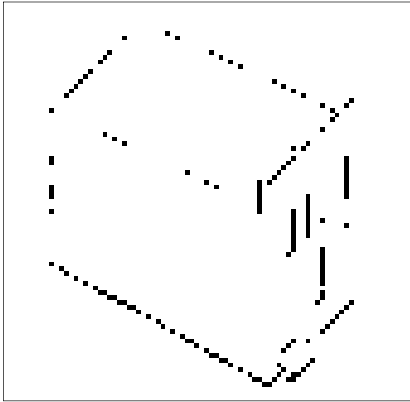

fig. 9

**Parapet.** An upward extension of a building wall above the roofline, sometimes ornamented and sometimes plain, used to give a building a greater feeling of height or a better sense of proportion. (figure 9)

**Period of Significance.** Span of time in which a property attained the significance.

**Post.** A piece of wood, metal, etc., usually long and square or cylindrical, set upright to support a building, sign, gate, etc.; pillar; pole. (figure 10)

**Preservation.** The act or process of applying measures to sustain the existing form, integrity and materials of a building or structure, and the existing form and vegetative cover of a site. It may include initial stabilization work, where necessary, as well as ongoing maintenance of the historic building materials.

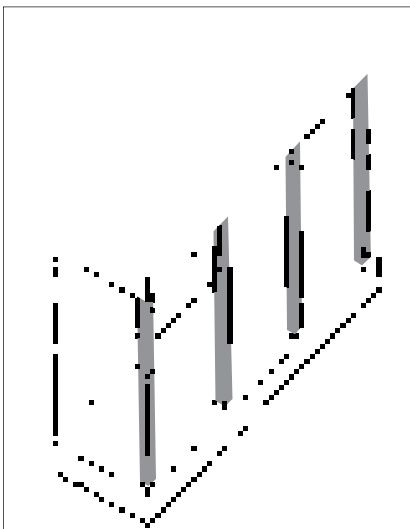

fig. 10

**Protection.** The act or process of applying measures designed to affect the physical condition of a property by defending or guarding it from deterioration, or to cover or shield the property from danger of injury. In the case of buildings and structures, such treatment is generally of a temporary nature and anticipates future historic preservation treatment; in the case of archaeological sites, the protective measure may be temporary or permanent.

**Reconstruction.** The act or process of reproducing by new construction the exact form and detail of a vanished building, structure or object, or part thereof, as it appeared at a specific period of time.

**Rehabilitation.** The act or process of returning a property to a state of utility through repair or alteration which makes possible an efficient contemporary use while preserving those portions or features of the property which are significant to its historical, architectural and cultural value.

**Renovation.** The act or process of returning a property to a state of utility through repair or alteration which makes possible a contemporary use.

**Restoration.** The act or process of accurately recovering the form and details of a property and its setting as it appeared at a particular period of time by means of the removal of later work or by the replacement of missing earlier work.

**Sash.** See window parts.

**Scale.** The size of structure as it appears to the pedestrian.

**Shape.** The general outline of a building or its facade.



---

**Side Light.** A usually long fixed sash located beside a door or window; often found in pairs. (figure 11)

**Siding.** The narrow horizontal or vertical wood boards that form the outer face of the walls in a traditional wood frame house. Horizontal wood siding is also referred to as clapboards. The term "siding" is also more loosely used to describe any material that can be applied to the outside of a building as a finish.

**Sill.** The lowest horizontal member in a frame or opening for a window or door. Also, the lowest horizontal member in a framed wall or partition.

**Size.** The dimensions in height and width of a building's face.

**Stile.** A vertical piece in a panel or frame, as of a door or window.

**Stabilization.** The fact or process of applying measures designed to reestablish a weather resistant enclosure and the structural stability of an unsafe or deteriorated property while maintaining the essential form as it exists at present.

**Storefront.** Exterior facade of a commercial building. Includes the following architectural elements: display window, transom, kickplate, entry, cornice molding, and upper story windows.

**Streetscape.** Generally, the streetscape refers to the character of the street, or how elements of the street form a cohesive environment.

**Traditional.** Based on or established by the history of the area.

**Transom Window.** A small window or series of panes above a door, or above a casement or double hung window.

**Vernacular.** This means that a building does not have details associated with a specific architectural style, but is a simple building with modest detailing and form. Historically, factors often influencing vernacular building were things such as local building materials, local climate and building forms used by successive generations.

**Visual Continuity.** A sense of unity or belonging together that elements of the built environment exhibit because of similarities among them.

**Window Parts.** The moving units of a window are known as sashes and move within the fixed frame. The sash may consist of one large pane of glass or may be subdivided into smaller panes by thin members called muntins or glazing bars. Sometimes in nineteenth-century houses windows are arranged side by side and divided by heavy vertical wood members called mullions.

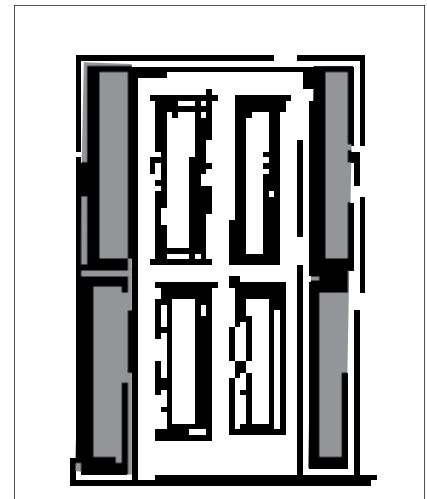

fig. 11

# Appendix D

## Historic Resources Map

